

Translations of  
**MATHEMATICAL  
MONOGRAPHS**

---

Volume 110

**Introduction  
to Complex Analysis**  
Part II  
**Functions of Several Variables**

B. V. Shabat



**American Mathematical Society**

Translations of  
**MATHEMATICAL  
MONOGRAPHS**

---

Volume 110

**Introduction  
to Complex Analysis**  
Part II  
Functions of Several Variables

B. V. Shabat



**American Mathematical Society**  
Providence, Rhode Island

Б. В. ШАБАТ

**ВВЕДЕНИЕ В КОМПЛЕКСНЫЙ  
АНАЛИЗ** ЧАСТЬ II

ФУНКЦИИ НЕСКОЛЬКИХ ПЕРЕМЕННЫХ

ИЗДАНИЕ ТРЕТЬЕ

Translated from the Russian by J. S. Joel  
Translation edited by Simeon Ivanov

1991 *Mathematics Subject Classification*. Primary 32-01, 32-02.

**ABSTRACT.** This book is based on several courses of lectures given by the author at Moscow State University. The book contains a detailed exposition of the main notions and ideas in the theory of functions in several complex variables. The translation is made from the 3rd Russian edition, into which the author included certain modern developments of the theory and its applications to physics. The book can serve as a textbook in a graduate course on functions in several complex variables.

**Library of Congress Cataloging-in-Publication Data**

Shabat, B. V. (Boris Vladimirovich)

[Vvedenie v kompleksnyi analiz. English]

Introduction to complex analysis/B. V. Shabat; [translated from the Russian by J. S. Joel].

v. (2 ); cm.—(Translations of mathematical monographs; v. (110))

Vol. (2 ) includes index. Contents: —pt. 2. Functions of several variables.

ISBN 0-8218-4611-6 (pt. 2: alk. paper)

1. Functions of complex variables. 2. Mathematical analysis. I. Title. II. Series.

QA331.7.S5213 1992

515'.94—dc20

92-19985

CIP

Copyright ©1992 by the American Mathematical Society. All rights reserved.

Translation authorized by the

All-Union Agency for Authors' Rights, Moscow.

The American Mathematical Society retains all rights  
except those granted to the United States Government.

Printed in the United States of America

Information on Copying and Reprinting can be found at the back of this volume.

The paper used in this book is acid-free and falls within the guidelines

established to ensure permanence and durability. Ⓜ

This publication was typeset using *AMS-TEX*,  
the American Mathematical Society's *TEX* macro system.

10 9 8 7 6 5 4 3 2 1 97 96 95 94 93 92

# Contents

Foreword to the Third Edition	ix
CHAPTER I. Holomorphic Functions of Several Variables	1
§1. Complex Euclidean space	1
1. The space $\mathbb{C}^n$	1
2. The simplest domains	6
§2. Holomorphic functions	12
3. The concept of holomorphy	12
4. Pluriharmonic functions	15
5. Simplest properties of holomorphic functions	18
6. The fundamental theorem of Hartogs	24
§3. Series expansions	29
7. Power series	29
8. Other series	33
§4. Holomorphic mappings	39
9. Properties of holomorphic mappings	39
10. Biholomorphic mappings	44
11. Fatou's example	54
Problems	58
CHAPTER II. Basic Geometric Concepts	61
§5. Manifolds and Stokes's formula	61
12. The concept of a manifold	61
13. Complexification of Minkowski space	67
14. Stokes's formula	77
15. The Cauchy-Poincaré theorem	83
16. Maxwell's equations	86
§6. Geometry of the space $\mathbb{C}^n$	96
17. Submanifolds of $\mathbb{C}^n$	96
18. Wirtinger's theorem	101
19. The Fubini-Study form and related topics	108



§7. Coverings	112
20. The concept of a covering	112
21. Fundamental groups and coverings	115
22. Riemann domains	121
§8. Analytic sets	123
23. The Weierstrass preparation theorem	123
24. Properties of analytic sets	129
25. Local structure	136
§9. Bundles and sheaves	140
26. The concept of a bundle	140
27. The tangent and cotangent bundles	143
28. The concept of a sheaf	148
Problems	152
CHAPTER III. Analytic Continuation	155
§10. Integral representations	155
29. The formulas of Martinelli-Bochner and Leray	155
30. Weil's formula	161
§11. Extension theorems	166
31. Extension from the boundary	166
32. Hartogs's theorem and the removal of singularities	173
§12. Domains of holomorphy	177
33. The concept of a domain of holomorphy	177
34. Holomorphic convexity	181
35. Properties of domains of holomorphy	185
§13. Pseudoconvexity	188
36. The continuity principle	188
37. Local pseudoconvexity	192
38. Plurisubharmonic functions	199
39. Pseudoconvex domains	206
§14. Envelopes of holomorphy	212
40. One-sheeted envelopes	212
41. Multiple-sheeted envelopes	217
42. Analyticity of the set of singularities	223
Problems	228
CHAPTER IV. Meromorphic Functions and Residues	231
§15. Meromorphic functions	231
43. The concept of a meromorphic function	231
44. The first Cousin problem	234
45. Solution of the first problem	238

§16. Methods of sheaf theory	242
46. Cohomology groups	242
47. Exact sequences of sheaves	247
48. Localized first Cousin problem	249
49. Second Cousin problem	253
§17. Applications	259
50. Applications of the Cousin problems	259
51. Solution of the Levi problem	262
52. Other applications	264
§18. Higher-dimensional residues	272
53. The theory of Martinelli	272
54. The theory of Leray	278
55. Logarithmic residue	286
Problems	292
CHAPTER V. Some Problems of Geometric Function Theory	295
§19. Invariant metrics	295
56. The Bergman metric	295
57. The Carathéodory metric	302
58. The Kobayashi metric	305
§20. Hyperbolic manifolds	308
59. Criteria for hyperbolicity	308
60. Generalizations of Picard's theorem	317
§21. Boundary properties	327
61. Mappings of strictly pseudoconvex domains	327
62. Correspondence of boundaries	332
63. A symmetry principle	336
64. Vector fields	341
65. Boundary properties of functions	347
66. Uniqueness theorems and propositions	352
Problems	359
APPENDIX. Complex Potential Theory	361
Subject Index	369



## Foreword to the Third Edition

This book is intended as a first study of higher-dimensional complex analysis, i.e., the theory of holomorphic functions of several complex variables, holomorphic mappings, and submanifolds of complex Euclidean space. It is a continuation of the author's book *Introduction to Complex Analysis. Part I*; (\*) some ideas that were only mentioned there can be found in this volume in their natural setting.

Higher-dimensional complex analysis is rather young in comparison with the one-dimensional theory. If we exclude works of G. Jacobi (1830 and 1857) and of F. Didon (1873), in which functions of two complex variables and integrals of them appear, and also those of Ch. Hermite (1852) and J. Sylvester (1854 and 1857), devoted to the solution of systems of equations in several unknowns, the beginnings of the higher-dimensional theory goes back to 1879 and the appearance of K. Weierstrass's paper *Some theorems related to the theory of analytic functions of several variables*. Another creator of the higher-dimensional theory is Henri Poincaré (1854–1912). In 1883 he published a paper in which he proved that a locally rational function of two variables is a quotient of two entire functions (in 1895 this result was extended to an arbitrary number of variables by P. Cousin, a student of Poincaré). In the same year, in joint work with E. Picard, he began the study of algebraic submanifolds of complex space. In papers from 1886 and 1887 Poincaré extended Cauchy's theorem to functions of two variables and established the foundations of a higher-dimensional theory of residues.

The first period of flowering of higher-dimensional complex analysis goes back to the beginning of this century. In 1907 Poincaré published a paper that anticipated later investigations of biholomorphic mappings of domains of complex Euclidean space. At roughly the same time there appeared a large series of papers by F. Hartogs, devoted to the analytic continuation of functions of several variables, as well as the important work of E. Levi.

However, later and for a rather long time, multidimensional problems of complex analysis remained in the background, and mathematicians con-

---

(\*) *Editor's note*. "Nauka", Moscow, 1985; French transl., "Mir", Moscow, 1990. Throughout the text of this book there will be references to Part I.

cerned with them formed a small portion of the specialists in the theory of functions of one complex variable.

The situation changed rapidly in the 1960s, when higher-dimensional problems began to attract the attention of mathematicians with other specialties and theoretical physicists. One of the reasons for this was apparently the investigations begun in the 1930s by H. Cartan, K. Oka, and others, which connected problems of higher-dimensional complex analysis with algebra, topology, and algebraic geometry. Another reason was the discoveries made in the 1950s by N. N. Bogolyubov, V. S. Vladimirov, R. Jost, A. Wightman, and others, applying the theory of functions of several complex variables to quantum field theory.

There ensued the second period of flowering of higher-dimensional complex analysis, which has continued until now. Both classical and new results in this area have found numerous applications in analysis, differential and algebraic geometry, and, in particular, in contemporary mathematical physics. The mastery of the foundations of higher-dimensional complex analysis in many areas of modern mathematics has become necessary for any specialist.

In correspondence with the rapid development of higher-dimensional complex analysis in the last decade, this book has been significantly reworked in comparison with the previous edition (1976), and it does not make sense to describe the changes in detail. We mention only that as an example of applications we have included an elementary presentation of the twistor method for solving Maxwell's equations, proposed recently by R. Penrose.

This volume is based on a "special course" I presented at Moscow University a number of times under the auspices of the department of "Function theory and functional analysis". In the work on this edition I have widely used suggestions by my friends and students, to all of whom I express my deep appreciation.

*B. V. Shabat*

## CHAPTER I

# Holomorphic Functions of Several Variables

Perhaps the biggest difficulty a beginner encounters in the transition to the study of functions of several complex variables is the absence of simple, intuitive geometric representations. From the very beginning, therefore, we notice the peculiarities of complex Euclidean space and we shall describe in detail a number of the simplest domains in it.

### §1. Complex Euclidean space

**1. The space  $\mathbb{C}^n$ .** We consider EVEN-DIMENSIONAL Euclidean space  $\mathbb{R}^{2n}$ , whose points are ordered sets of  $2n$  real numbers  $(x_1, \dots, x_{2n})$ . We introduce a complex structure in it, by setting  $z_\nu = x_\nu + ix_{n+\nu}$  ( $\nu = 1, \dots, n$ ). We shall often write  $x_{n+\nu} = y_\nu$ , so that  $z_\nu = x_\nu + iy_\nu$  ( $\nu = 1, \dots, n$ ). We shall call the space whose points are ordered sets of  $n$  complex numbers

$$z = (z_1, \dots, z_n), \quad (1)$$

the  $n$ -dimensional *complex Euclidean space* and we denote it by the symbol  $\mathbb{C}^n$ . In particular, for  $n = 1$  we obtain  $\mathbb{C}^1 = \mathbb{C}$ , the complex plane. The space  $\mathbb{C}^n$  is the Cartesian product of  $n$  planes

$$\mathbb{C}^n = \underbrace{\mathbb{C} \times \dots \times \mathbb{C}}_{n \text{ times}}. \quad (2)$$

Thus the points of  $n$ -dimensional complex Euclidean space  $\mathbb{C}^n$  are the points of  $2n$ -dimensional real Euclidean space  $\mathbb{R}^{2n}$ . However, the introduction of a complex structure in  $\mathbb{R}^{2n}$  immediately introduces an ASYMMETRY into this space—the coordinates in it are not all equivalent (for example,  $x_1$  and  $x_{n+1}$  are combined into the complex number  $z_1$ , but  $x_1$  and  $x_2$  are not combined).

One can naturally introduce the structure of a *vector space* over the field  $\mathbb{C}$  in  $\mathbb{C}^n$ ; addition and multiplication by a complex scalar  $\lambda$  are defined coordinate-by-coordinate:  $z + w = (z_1 + w_1, \dots, z_n + w_n)$  and  $\lambda z = (\lambda z_1, \dots, \lambda z_n)$ . A vector  $z \in \mathbb{C}^n$  is sometimes written in the form  $z = x + iy$ , where  $x = (x_1, \dots, x_n)$  and  $y = (y_1, \dots, y_n)$  are vectors belonging to  $\mathbb{R}^n$ . The space  $\mathbb{R}^n(x)$ , consisting of vectors of the form  $z = x + i0$ , is called the *real subspace* of  $\mathbb{C}^n$  (for  $n = 1$  this is the real axis).

The space  $\mathbb{C}^n$  has a *Hermitian scalar product*

$$(z, w) = \sum_{\nu=1}^n z_{\nu} \overline{w}_{\nu}, \quad (3)$$

with the obvious properties

$$(w, z) = \overline{(z, w)}, \quad (\lambda z, w) = \lambda(z, w) \quad (4)$$

for any  $\lambda \in \mathbb{C}$ . If  $z_{\nu} = x_{\nu} + ix_{n+\nu}$  and  $w_{\nu} = u_{\nu} + iu_{n+\nu}$ , then according to (3) we have

$$(z, w) = \sum_{\nu=1}^{2n} x_{\nu} u_{\nu} + i \sum_{\nu=1}^n (x_{n+\nu} u_{\nu} - x_{\nu} u_{n+\nu}),$$

from which we see that the real part of the Hermitian scalar product  $\operatorname{Re}(z, w)$  is the *Euclidean scalar product* of  $z$  and  $w$ , considered as vectors of  $\mathbb{R}^{2n}$ . The imaginary part  $\operatorname{Im}(z, w)$  changes sign if  $z$  and  $w$  are interchanged, and for  $z = w$  it vanishes:

$$(z, z) = \sum_{\nu=1}^{2n} x_{\nu}^2 \quad \text{or} \quad |z|^2 = \sum_{\nu=1}^n |z_{\nu}|^2 \quad (5)$$

is the square of the Euclidean length (modulus) of  $z$  as a vector of  $\mathbb{R}^{2n}$ . Another obvious relation is that  $\operatorname{Im}(z, w) = \operatorname{Re}(z, iw)$ .

The *real hyperplane* in  $\mathbb{C}^n$  containing the point  $z^0$  is the set of points  $z$  such that the vector  $z - z^0$  is real orthogonal to a fixed vector  $a \neq 0$ :

$$\operatorname{Re}(z - z^0, a) = 0 \quad \text{or} \quad \operatorname{Re}(z, a) = \beta, \quad (6)$$

where  $\beta$  is a real constant. Every such hyperplane is fibered into planes of real codimension 2:

$$(z, a) = b, \quad (7)$$

where  $b = \beta + i\beta'$  and  $\beta'$  is an arbitrary real number.<sup>(1)</sup> The planes that are represented by equations of the form (7) are called *complex hyperplanes* in  $\mathbb{C}^n$ .

Now suppose we are given  $k \leq 2n$  vectors  $a^{\mu} \in \mathbb{C}^n$  that are linearly independent over  $\mathbb{R}$ ; the set of points  $z \in \mathbb{C}^n$  that is described by the system of  $k$  real equations

$$\operatorname{Re}(z, a^{\mu}) = \beta_{\mu}, \quad \mu = 1, \dots, k, \quad (8)$$

is called a *real plane* of codimension  $k$  or dimension  $m = 2n - k$  (for  $k = 2n$  this is a point). If the vectors  $a^{\mu}$  are also linearly independent over  $\mathbb{C}$  (then

<sup>(1)</sup>In fact, the complex equation (7) is equivalent to two real equations:  $\operatorname{Re}(z, a) = \beta$ ,  $\operatorname{Im}(z, a) = \beta'$ . The first equation is the same as (6), while the second one can be rewritten in the form  $\operatorname{Re}(z, ia) = \beta'$ , and hence represents a real hyperplane that is obviously different from (6).

$k \leq n$ , where  $k$  is the number of such vectors), then the set described by the system of complex equations

$$(z, a^\mu) = b_\mu, \quad \mu = 1, \dots, k, \quad (9)$$

is called a *complex plane* of codimension  $k$  or dimension  $m = n - k$ . Since this system can be rewritten as  $2k$  real linear equations  $\operatorname{Re}(z, a^\mu) = \operatorname{Re} b_\mu$ ,  $\operatorname{Re}(z, ia^\mu) = \operatorname{Im} b_\mu$ , and the vectors  $a^\mu$  and  $ia^\mu$  ( $\mu = 1, \dots, k$ ) are linearly independent over  $\mathbb{R}$ , then this is a plane of real codimension  $2k$ .

However, not every plane  $\Pi \subset \mathbb{C}^n$  of even real codimension is a complex plane—this reflects the asymmetry that arises from the introduction of the complex structure (which we discussed above). For planes that contain the point  $z = 0$  it is possible to give a simple rule: *a plane  $\Pi \ni 0$  is complex if and only if  $iz \in \Pi$  for every  $z \in \Pi$ .*

The necessity of this condition is obvious, since the equation  $(z, a^\mu) = 0$  implies that we also have  $(iz, a^\mu) = 0$ . Conversely, if  $\Pi$  satisfies the condition, then  $z \in \Pi$  implies that  $(\alpha + i\alpha')z \in \Pi$  for any  $\alpha, \alpha' \in \mathbb{R}$ , i.e.,  $\Pi$  is a complex subspace of  $\mathbb{C}^n$ . If we choose a basis  $a^1, \dots, a^k$  in the orthogonal complement to  $\Pi$  (relative to the Hermitian metric in  $\mathbb{C}^n$ ), then the fact that  $z$  belongs to  $\Pi$  is written by the equations  $(z, a^\mu) = 0$ ,  $\mu = 1, \dots, k$ , but this means that  $\Pi$  is a complex plane.

EXAMPLE. The plane  $\Pi_1 = \{z \in \mathbb{C}^2 : z_1 = z_2\}$  is a complex plane, since  $iz_1 = iz_2$  if  $z_1 = z_2$ . The plane  $\Pi_2 = \{z \in \mathbb{C}^2 : z_1 = \bar{z}_2\}$ , which has the same real dimension 2 as  $\Pi_1$ , is not a complex plane, since if  $z_1 = \bar{z}_2$ , then  $iz_1 \neq i\bar{z}_2$  if  $z_2 \neq 0$ .

We note that in contrast to hyperplanes real planes of codimension  $k > 1$  do not necessarily contain (nontrivial) complex planes. For a plane  $\Pi \ni 0$  the complex plane  $\Pi^c \subset \Pi$  of maximal dimension is obviously the intersection of  $\Pi$  with the plane  $i\Pi$ , consisting of the vectors  $iz$ , where  $z \in \Pi$ . For  $k > 1$  the intersection  $\Pi^c = \Pi \cap i\Pi$  may reduce to the point  $z = 0$  (as for the plane  $\Pi_2$  in the preceding example).

Complex one-dimensional planes are called *complex lines*.<sup>(2)</sup> They are defined by a system of  $n - 1$  complex linear equations, which can be written in the form

$$\frac{z_1 - z_1^0}{\omega_1} = \dots = \frac{z_n - z_n^0}{\omega_n}, \quad (10)$$

where  $z^0 = (z_1^0, \dots, z_n^0)$  is one of the points of the line, and the vector  $\omega = (\omega_1, \dots, \omega_n) \neq 0$  determines its direction (it is defined up to a complex proportionality factor). Denoting the common quantity of the fractions in (10) by  $\zeta$ , the equation of a complex line can be written in the parametric form:

$$z = z^0 + \omega\zeta. \quad (11)$$

In  $\mathbb{C}^n$  one has the usual *Euclidean metric*, according to which the distance between the points  $z$  and  $w$  is equal to  $|z - w|$ ; the Hermitian form of this

<sup>(2)</sup>In fact they are real two-dimensional planes!



metric is

$$ds^2 = \sum_{\nu=1}^{2n} dx_{\nu}^2 = \sum_{\nu=1}^n |dz_{\nu}|^2, \quad (12)$$

where  $|dz_{\nu}|^2 = dx_{\nu}^2 + dx_{n+\nu}^2$ . Sometimes we also consider the metric in which the distance between the points  $z$  and  $w$  is understood as

$$\|z - w\| = \max_{\nu} |z_{\nu} - w_{\nu}|. \quad (13)$$

\* Prove that  $\rho(z, w) = \|z - w\|$  satisfies the axioms of being a metric: (a)  $\rho(z, w) = \rho(w, z)$ , the axiom of symmetry; (b)  $\rho(z, w) \geq 0$  and equality holds only for  $z = w$ ; (c)  $\rho(z, w) \leq \rho(z, w') + \rho(w', w)$ , the triangle inequality.\*

The balls  $\{\|z - a\| < r\}$  in the metric (13) are the product of the discs  $\{|z_{\nu} - a_{\nu}| < r\}$  by the complex lines  $\mathbb{C}(z_{\nu})$  and are called *polydiscs* (see the following subsection). In correspondence with this the metric (13) is called a *polydisc metric*. The obvious double inequality

$$\|z - w\| \leq |z - w| \leq \sqrt{n}\|z - w\| \quad (14)$$

shows that both metrics introduce the same topology on  $\mathbb{C}^n$ .

To conclude we shall describe the **COMPACTIFICATION** of  $\mathbb{C}^n$ , i.e., its completion by infinite elements. For this we introduce homogeneous coordinates  $\omega_0, \dots, \omega_n$ , setting

$$z_{\nu} = \frac{\omega_{\nu}}{\omega_0} \quad (\nu = 1, \dots, n; \omega_0 \neq 0). \quad (15)$$

These coordinates are determined by the point  $z$  up to a complex proportionality factor  $\lambda \neq 0$  and conversely, to any set  $\omega = (\omega_0, \dots, \omega_n)$ ,  $\omega_0 \neq 0$ , and a set  $\lambda\omega$  proportional to it, by formula (15) we associate the same point  $z \in \mathbb{C}^n$ . Removing the singular position of the coordinate  $\omega_0$ , we complete  $\mathbb{C}^n$  by *improper* (infinite) elements, which correspond to sets of the form  $(0, \omega_1, \dots, \omega_n) \neq 0$ . Then to arbitrary sets  $\omega = (\omega_0, \dots, \omega_n) \neq 0$  we will associate the points of some space, which we call the *complex projective space* and denote it by  $\mathbb{CP}^n$  or simply  $\mathbb{P}^n$ . More precisely, the points are not the sets  $\omega$  themselves, but their equivalence classes according to the following relation:  $\omega' \sim \omega''$  if these sets are proportional, i.e.,  $\omega'' = \lambda\omega'$  for some complex number  $\lambda \neq 0$ . The equivalence class that contains the set  $\omega$  is denoted by  $[\omega]$ .

For the compactification we have added to  $\mathbb{C}^n$  the points  $[0, \omega]$ , where  $\omega = (\omega_1, \dots, \omega_n) \neq 0$ . These points can be identified with the equivalence classes  $[\omega]$ , the set of which is, obviously, a complex projective space of dimension  $n - 1$ , which we denote by  $\mathbb{P}_{\infty}^{n-1}$ . Thus

$$\mathbb{P}^n = \mathbb{C}^n + \mathbb{P}_{\infty}^{n-1}, \quad (16)$$

and only in the case  $n = 1$  is the compactification obtained by adding a single point:  $\mathbb{P}^1 = \overline{\mathbb{C}} = \mathbb{C} + \{\infty\}$ .

\* Prove that any complex line  $l \subset \mathbb{C}^n$  is completed by a single point in the compactification.\*

A good geometric representation of an equivalence class  $[\omega]$  is given by a complex line in  $\mathbb{C}^{n+1}$  that passes through the origin:

$$\frac{z_1}{\omega_0} = \dots = \frac{z_{n+1}}{\omega_n};$$

its direction  $\omega = (\omega_0, \dots, \omega_n)$  is also determined up to a complex factor  $\lambda \neq 0$ , and inequivalent sets correspond to different lines. Thus,  $\mathbb{P}^n$  can be represented as the set of complex lines in  $\mathbb{C}^{n+1}$  that pass through the origin. In particular, points of  $\mathbb{C}^n$  correspond to lines for which  $\omega_0 \neq 0$ , and the points at infinity correspond to lines for which  $\omega_0 = 0$  (orthogonal to the vector  $(1, 0, \dots, 0) \in \mathbb{C}^{n+1}$ ).

A line  $l: z = \omega\zeta$  ( $\omega \in \mathbb{C}^{n+1}$ ,  $\zeta \in \mathbb{C}$ ) is completely characterized by its intersection with the sphere  $S^{2n+1} = \{z \in \mathbb{C}^{n+1} : |z| = 1\}$ . If (without loss of generality) we set  $|\omega| = 1$ , then this intersection will be described by the condition  $|\omega\zeta| = |\zeta| = 1$ , i.e., it is a circle on the complex line  $l$ . Identifying these circles of the intersection  $l \cap S^{2n+1}$  with points,<sup>(3)</sup> we obtain yet another model of  $\mathbb{P}^n$ . It is the complex analogue of the well-known model of real projective space  $\mathbb{R}\mathbb{P}^n$ , in which the points are identified pairs of points of intersection of a real line with a sphere in  $\mathbb{R}^{n+1}$ .

This model allows us to introduce a natural metric in  $\mathbb{P}^n$ . Namely, for the distance between the points  $[\omega]$  and  $[\omega']$  we take the Euclidean distance in  $\mathbb{C}^{n+1}$  between the circles  $\gamma$  and  $\gamma'$  that represent these points on the sphere  $S^{2n+1}$  (we assume that  $|\omega| = |\omega'| = 1$ ). An elementary computation gives

$$\begin{aligned} \rho^2([\omega], [\omega']) &= \min_{\theta, \theta'} |\omega e^{i\theta} - \omega' e^{i\theta'}|^2 \\ &= \min_{\theta, \theta'} 2\{1 - \operatorname{Re}[(\omega, \omega')e^{i(\theta-\theta')}] \} = 2(1 - |(\omega, \omega')|) \end{aligned}$$

or, if  $\omega$  and  $\omega'$  have arbitrary modulus,

$$\rho^2([\omega], [\omega']) = 2 \left( 1 - \frac{|(\omega, \omega')|}{|\omega||\omega'|} \right). \quad (17)$$

Setting  $\omega' = \omega + d\omega$  here and ignoring small terms of higher than second order relative to  $|d\omega|$ , we obtain the corresponding metric form:

$$ds^2 = \frac{(\omega, \omega)(d\omega, d\omega) - (\omega, d\omega)(d\omega, \omega)}{(\omega, \omega)^2}. \quad (18)$$

This metric is called the *Fubini-Study metric*. It is the multidimensional generalization of the spherical metric in  $\mathbb{C} = \mathbb{P}^1$  (if for  $n = 1$  we introduce

<sup>(3)</sup>The sphere  $S^{2n+1}$  has real dimension  $2n + 1$ , and the identification of circles with points lowers the dimension by 1. Therefore, the real dimension of our model is  $2n$ .

the local coordinate  $z = \omega_1/\omega_0$ , then (18) can be rewritten in the form  $ds^2 = |dz|^2/(1 + |z|^2)^2$ , and this is the form of the spherical metric).

\* 1. Prove that the distance defined by formula (17) satisfies the axioms of being a distance. (HINT: in proving the triangle inequality use the concept of distance between sets.)

2. Sometimes for the distance between points  $[\omega], [\omega'] \in \mathbb{P}^n$  one takes the quantity  $d = \arccos \frac{|(\omega, \omega')|}{|\omega||\omega'|}$ . Prove that  $d$  is expressed via  $\rho$  according to the formula  $d = 2\arcsin \frac{\rho}{2}$  and is equal to the minimal angle between the real lines that belong respectively to the complex lines in  $\mathbb{C}^{n+1}$  that represent  $[\omega]$  and  $[\omega']$ . \*

Finally we note that in some questions one uses a different compactification of  $\mathbb{C}^n$ , leading to the so-called *function-theoretic space*  $\overline{\mathbb{C}}^n = \overline{\mathbb{C}} \times \dots \times \overline{\mathbb{C}}$  ( $n$  times). The set of points at infinity of  $\overline{\mathbb{C}}^n$  is partitioned into the  $n$  sets  $\{z \in \overline{\mathbb{C}}^n : z_\nu = \infty, z_\mu \in \overline{\mathbb{C}} \text{ for } \mu \neq \nu\}$ , each of which has complex dimension  $n - 1$ ; they all intersect in the point  $(\infty, \dots, \infty)$ .

**2. The simplest domains.** Here we shall describe some of the simplest examples of domains in the space  $\mathbb{C}^n$ . As usual, a domain is an open connected set, where openness means that along with any point of it the set also contains a neighborhood of that point, and connectedness of an open set  $D$  means that, for any points  $z', z'' \in D$  there exists a continuous arc  $\gamma: [0, 1] \rightarrow D$  for which  $\gamma(0) = z'$  and  $\gamma(1) = z''$ .

1. The **BALL** of radius  $r$  with center at the point  $a \in \mathbb{C}^n$  is defined as the set of points

$$B(a, r) = \{z \in \mathbb{C}^n : |z - a| < r\}. \quad (1)$$

This is the usual Euclidean ball; its boundary  $\partial B$  is the  $(2n - 1)$ -dimensional sphere

$$S^{2n-1} = \{z \in \mathbb{C}^n : |z - a| = r\}.$$

2. The **POLYDISC** (OR **POLYCYLINDER**) of radius  $r$  with center  $a \in \mathbb{C}^n$  is defined as the set of points

$$U(a, r) = \{z \in \mathbb{C}^n : \|z - a\| < r\}. \quad (2)$$

This is a ball with center  $a$  in the polydisc metric  $\rho$ . It is the product of  $n$  plane discs of radius  $r$  with centers at the points  $a_\nu$ . We can also consider the more general case of a polydisc with center  $a$  and **VECTOR** radius  $r = (r_1, \dots, r_n)$ :

$$U(a, r) = \{z \in \mathbb{C}^n : |z_\nu - a_\nu| < r_\nu, \nu = 1, \dots, n\}. \quad (3)$$

The boundary  $\partial U$  of a polydisc is the set of all points for which at least one coordinate  $z_\nu$  belongs to the boundary of the  $\nu$ th disc forming  $U$ , and the remaining coordinates  $z_\mu$  ( $\mu \neq \nu$ ) vary arbitrarily in closed discs. This boundary is partitioned in a natural way into  $n$  sets

$$\Gamma^\nu = \{z : |z_\nu - a_\nu| = r_\nu, |z_\mu - a_\mu| \leq r_\mu, \mu \neq \nu\},$$

each of which is  $(2n - 1)$ -dimensional (since the  $2n$  coordinates of the point  $z$  are connected by the single real relation  $|z_\nu - a_\nu| = r_\nu$ ). Therefore the

entire boundary of the polydisc  $\partial U = \bigcup_{\nu=1}^n \Gamma^\nu$  is  $(2n - 1)$ -dimensional. All the sets  $\Gamma^\nu$  intersect in the  $n$ -dimensional set

$$\Gamma = \{z : |z_\nu - a_\nu| = r_\nu, \nu = 1, \dots, n\},$$

which is called the *skeleton* (\*) of the polydisc and is the product of  $n$  circles.

We now describe in more detail the bidisc of radius 1 with center at the origin:

$$U = \{z \in \mathbb{C}^2 : |z_1| < 1, |z_2| < 1\}.$$

This four-dimensional solid is the intersection of two cylinders:

$$x_1^2 + x_3^2 < 1 \quad \text{and} \quad x_2^2 + x_4^2 < 1.$$

Its boundary is the three-dimensional solid  $\partial U = \Gamma^1 \cup \Gamma^2$ , where  $\Gamma^1 = \{|z_1| = 1, |z_2| \leq 1\}$  is also a three-dimensional solid which is fibered into a one-parameter family of discs:  $\Gamma^1 = \bigcup_{\theta=0}^{2\pi} \{z_1 = e^{i\theta}, |z_2| \leq 1\}$ , and  $\Gamma^2$  is an analogous solid. The skeleton  $\Gamma = \Gamma^1 \cap \Gamma^2$  of the bidisc is two-dimensional. It is the torus  $\Gamma = \{|z_1| = 1, |z_2| = 1\}$ ; in fact, the mapping  $z_1 = e^{i\theta_1}$ ,  $z_2 = e^{i\theta_2}$  maps the square  $\{0 \leq \theta_1 \leq 2\pi, 0 \leq \theta_2 \leq 2\pi\}$  homeomorphically onto  $\Gamma$  with the opposite sides identified (since  $e^{i(\theta_\nu + 2\pi)} = e^{i\theta_\nu}$ ), as shown in Figure 1, and such an identification gives a torus. The torus  $\Gamma$  is fibered into one-parameter families of circles  $\{z_1 = e^{i\theta_1}, |z_2| = 1\}$  and  $\{|z_1| = 1, z_2 = e^{i\theta_2}\}$ ,  $0 \leq \theta_1, \theta_2 < 2\pi$  (in Figure 1 we have shown one representative of each family). It is the intersection of the two three-dimensional cylinders  $\{x_1^2 + x_3^2 = 1\}$  and  $\{x_2^2 + x_4^2 = 1\}$ , and obviously lies in  $\mathbb{R}^4$  on the (three-dimensional) sphere  $\{x_1^2 + x_2^2 + x_3^2 + x_4^2 = 2\}$ .

Thus, the bidisc is represented geometrically as follows. In  $\mathbb{C}^2$  we take the (three-dimensional) sphere  $\{|z| = \sqrt{2}\}$  and on it we choose the torus

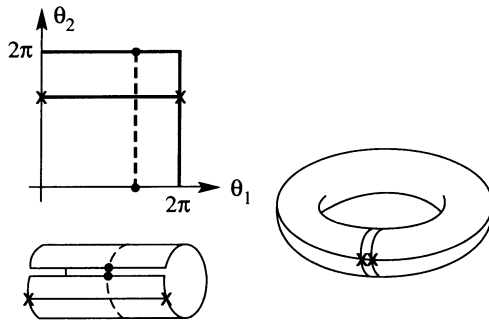

FIGURE 1

(\*) Editor's note. Or distinguished boundary.

$\Gamma = \{|z_1| = 1, |z_2| = 1\}$ . On this torus we stretch two three-dimensional solids  $\Gamma^1 = \{|z_1| = 1, |z_2| \leq 1\}$  and  $\Gamma^2 = \{|z_1| \leq 1, |z_2| = 1\}$  lying in the ball layer  $\{1 \leq |z| \leq \sqrt{2}\}$ ; their union  $\Gamma^1 \cup \Gamma^2$  bounds the bidisc.

3. **POLY-CIRCULAR (OR POLYCYLINDRICAL) DOMAINS** in  $\mathbb{C}^n$  are defined as the product of  $n$  plane domains:

$$D = D_1 \times \cdots \times D_n \quad (4)$$

(polydiscs are special cases of such domains). If all the  $D_\nu$  are simply connected domains, then  $D$  is homeomorphic to a ball. The boundary  $\partial D$  of a polycircular domain  $D$  is partitioned into  $n$  sets of dimension  $(2n - 1)$ :

$$\Gamma^\nu = \{z : z_\nu \in \partial D_\nu, z_\mu \in \bar{D}_\mu, \mu \neq \nu\}.$$

The common part of all the  $\Gamma^\nu$  is the  $n$ -dimensional set

$$\Gamma = \{z : z_\nu \in \partial D_\nu, \nu = 1, \dots, n\},$$

which is called the *skeleton* of the polycircular domain  $D$ .

4. **REINHARDT DOMAINS (OR  $n$ -CIRCULAR DOMAINS)** with center at a point  $a \in \mathbb{C}^n$  are defined as domains that possess the following property: for any point  $z^0 = \{z_\nu^0\}$  that belongs to the domain, the domain also contains any point

$$z = \{a_\nu + (z_\nu^0 - a_\nu)e^{i\theta_\nu}\}, \quad 0 < \theta_\nu < 2\pi.$$

A Reinhardt domain with center  $a$  is said to be *complete* if along with each point  $z^0$  it contains all points  $z = \{z_\nu\}$  for which  $|z_\nu - a_\nu| \leq |z_\nu^0 - a_\nu|$ ,  $\nu = 1, \dots, n$ .

It is obvious that balls and polydiscs are complete Reinhardt domains. For  $n = 1$  the incomplete Reinhardt domains are the annuli  $\{r < |z - a| < R\}$  and the complete domains are the discs  $\{|z - a| < R\}$ .

Without loss of generality we may assume that the center  $a$  of a Reinhardt domain is the origin  $a = 0$  (by making a translation). Such a domain together with each point  $\{z_\nu\}$  contains all points with the same  $|z_\nu|$ ,  $\nu = 1, \dots, n$ , and all possible arguments. Taking this remark into consideration, we can consider the mapping

$$z \rightarrow \alpha(z) = (|z_1|, \dots, |z_n|) \quad (5)$$

from the  $2n$ -dimensional space  $\mathbb{C}^n$  into the  $n$ -dimensional space  $\mathbb{R}^n$ , more precisely, into the so-called *absolute orthant*  $\mathbb{R}_+^n = \mathbb{R}_+ \times \cdots \times \mathbb{R}_+$  ( $n$  times), where  $\mathbb{R}_+ = [0, \infty)$  is the half-axis of nonnegative numbers. This mapping  $\alpha: \mathbb{C}^n \rightarrow \mathbb{R}_+^n$  transforms a Reinhardt domain  $D$  into a set of points  $D_+ \subset \mathbb{R}_+^n$ , which we shall call the image (or diagram) of the Reinhardt domain  $D$ . If  $D$  is a complete Reinhardt domain, then  $D_+$  together with each point  $\{|z_\nu^0|\}$  contains the whole rectangular parallelepiped  $\{|z_\nu| \leq |z_\nu^0|, \nu = 1, \dots, n\}$ .

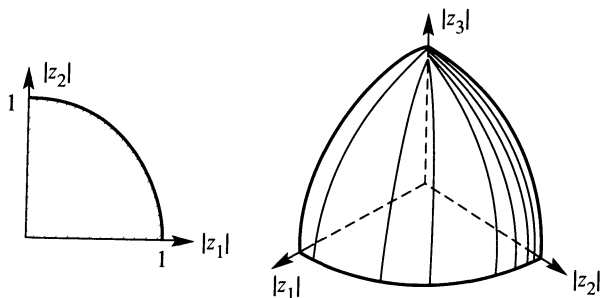

FIGURE 2

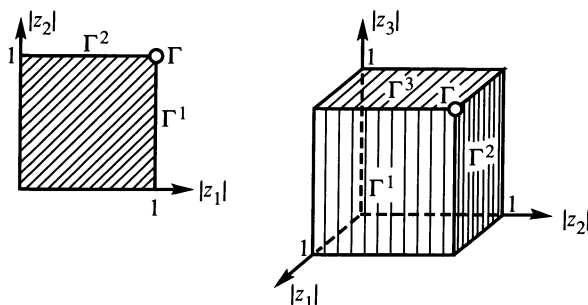

FIGURE 3

This diagram completely characterizes Reinhardt domains, and since it lowers the dimension by  $n$  for  $n = 2$  and  $n = 3$  we can draw this image. Figures 2 and 3 respectively contain pictures of the Reinhardt diagrams of the ball  $\{|z| < 1\}$  and the polydisc  $\{|z_\nu| < 1\}$  for  $n = 2$  and  $n = 3$ ; in the second of them we have shown the sets  $\Gamma^\nu$  and the skeleton  $\Gamma$ .

5. HARTOGS DOMAINS with symmetry plane  $\{z_n = a_n\}$  are defined as domains possessing the following property: together with each point  $z^0 = \{z_\nu^0\}$  the domain also contains any point  $z = (z_1^0, \dots, z_{n-1}^0, a_n + (z_n^0 - a_n)e^{i\theta_n})$ ,  $0 < \theta_n < 2\pi$ . A Hartogs domain is said to be *complete* if together with each point  $z^0$  it contains all points  $z$  such that  $z_\nu = z_\nu^0$  ( $\nu = 1, \dots, n-1$ ) and  $|z_n - a_n| \leq |z_n^0 - a_n|$ . It is obvious that Hartogs domains form a wider class than Reinhardt domains.

Hartogs domains with the symmetry plane  $\{z_n = 0\}$  can be pictured in a space of dimension  $(2n-1)$  if we take the transformation  $\beta: \mathbb{C}^n \rightarrow \mathbb{C}^{n-1} \times \mathbb{R}_+$  defined by the formula

$$z \rightarrow \beta(z) = \{z_1, \dots, z_{n-1}, |z_n|\}. \quad (6)$$

As an abbreviation we denote by  $'z = (z_1, \dots, z_{n-1})$  the projection of  $z$  into  $\mathbb{C}^{n-1}$  and by  $'D$  the projection of  $D$  into  $\mathbb{C}^{n-1}$  (i.e., the set of all  $'z$  for  $z \in D$ ). The image of a complete Hartogs domain together with each

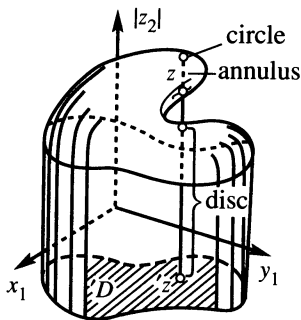

FIGURE 4

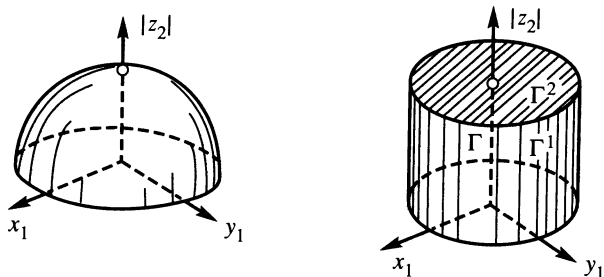

FIGURE 5

point  $(z^0, |z_n^0|)$  contains the entire segment  $\{(z^0, |z_n|) : |z_n| \leq |z_n^0|\}$ .

The Hartogs diagram lowers the dimension by 1 and for  $n = 2$  it can be drawn completely. Figure 4 contains a picture of an incomplete Hartogs domain; it is important to keep in mind that a point in this diagram is a circle, and a vertical segment over  $D$  is a disc. Figure 5 shows a ball in  $\mathbb{C}^2$  and a bidisc; in the picture one can clearly see the boundary pieces  $\Gamma^1$  and  $\Gamma^2$  and the skeleton  $\Gamma$  of the bidisc.

6. CIRCULAR DOMAINS with center at a point  $a \in \mathbb{C}^n$  are domains which, for each point  $z$ , also contain all the points  $a + (z - a)e^{i\theta}$ ,  $0 < \theta < 2\pi$ , i.e., the circle on the complex line, passing through  $z$  and  $a$ , with center  $a$  and radius  $|z - a|$ . COMPLETE circular domains contain along with  $z$  the entire disc  $\{a + (z - a)\zeta, |\zeta| \leq 1\}$ . If  $a = 0$ , then the simple transformation  $(z_1, \dots, z_n) \rightarrow (z_1/z_n, \dots, z_{n-1}/z_n, z_n)$  maps a circular domain into a Hartogs domain (this transformation has a singularity for  $z_n = 0$  and is defined only on  $D \setminus \{z_n = 0\}$ ).

7. TUBE (OR CYLINDRICAL) DOMAINS are defined as domains with the following property: if  $z^0 = \{z_\nu^0\}$  is in the domain, then so is any point  $z = \{z_\nu^0 + iy_\nu\}$ ,  $-\infty < y_\nu < \infty$ ,  $\nu = 1, \dots, n$ . Any tube domain can be represented as a product  $B \times \mathbb{R}^n(y)$ , where  $B$ , the so-called *base* of the domain,

is some domain of the  $n$ -dimensional real space  $\mathbb{R}^n(x)$ ,  $x = (x_1, \dots, x_n)$ , and  $\mathbb{R}^n(y)$  is the real space of the points  $y = (y_1, \dots, y_n)$ . Thus, a tube domain is completely characterized by its base  $B$ , a domain of  $n$ -dimensional real Euclidean space.

Setting  $z = x + iy$ , where  $x$  and  $y$  are real  $n$ -dimensional vectors, a tube domain can be written symbolically in the form  $T = B + i\mathbb{R}^n(y)$ , or, in more detail,  $T = \{x + iy : x \in B, y \in \mathbb{R}^n\}$ . For  $n = 1$  the tube domains are obviously the strips  $\{\alpha < x < \beta, -\infty < y < \infty\}$  and the half-planes  $\{x > \alpha\}$  or  $\{x < \alpha\}$ .

We note that the mapping  $\varphi: z_\nu \rightarrow e^{z_\nu}$  ( $\nu = 1, \dots, n$ ) transforms a tube domain  $T$  into a Reinhardt domain  $D$ . Here the base  $B$  corresponds to  $D_+$ , the image of  $D$  on the Reinhardt diagram.

8. GENERALIZED UPPER HALF-PLANE. In some questions it is convenient to represent points  $z \in \mathbb{C}^{n^2}$  by square matrices  $Z = (z_{jk})$ ,  $j, k = 1, \dots, n$ . Let  $Z^* = (\bar{z}_{kj})$  be the conjugate transpose of  $Z$ ; set

$$\operatorname{Im} Z = \frac{1}{2i}(Z - Z^*). \quad (7)$$

This matrix is obviously Hermitian: its elements  $w_{jk} = \frac{1}{2i}(z_{jk} - \bar{z}_{kj})$  satisfy the condition  $w_{kj} = \bar{w}_{jk}$  and, in particular,  $w_{jj} = \operatorname{Im} z_{jj}$  are real. As a convention, for a Hermitian matrix  $W$  we write  $W > 0$  if this matrix is positive definite, i.e., all its eigenvalues are positive.

A *generalized upper half-plane* is a domain

$$H = \{Z \in \mathbb{C}^{n^2} : \operatorname{Im} Z > 0\}. \quad (8)$$

For  $n = 1$  this is the usual upper half-plane. The boundary  $\partial H$  of this domain consists of the matrices  $Z$  for which  $\operatorname{Im} Z$  is a nonnegative, but not positive definite, Hermitian matrix (its eigenvalues are nonnegative and at least one of them is equal to zero). Since the vanishing of eigenvalues of a Hermitian matrix is expressed by a real-analytic equality, it follows that  $\partial H$  consists of pieces of real-analytic surfaces of dimension  $2n^2 - 1$ .

On  $\partial H$  there is a set  $\Gamma = \{Z : \operatorname{Im} Z = 0\}$ , which is called the *skeleton* on the upper half-plane  $H$ . It consists of points represented by matrices  $Z = (z_{jk})$  for which  $z_{jk} = \bar{z}_{kj}$ , i.e., Hermitian matrices. The condition of Hermiticity is expressed by  $n^2$  independent equations, so that the real dimension of  $\Gamma$  is equal to  $n^2$ .

We note in particular the case  $n = 2$ , i.e., the space  $\mathbb{C}^4$ . Here the generalized upper half-plane

$$H = \left\{ Z \in \mathbb{C}^4 : \begin{pmatrix} y_{11} & \frac{z_{12} - \bar{z}_{21}}{2i} \\ \frac{z_{21} - \bar{z}_{12}}{2i} & y_{22} \end{pmatrix} > 0 \right\} \quad (9)$$

is defined by the inequalities  $y_{11} > 0$  and  $y_{11}y_{22} - \frac{1}{4}|z_{12} - \bar{z}_{21}|^2 > 0$  (we have set  $z_{jk} = x_{jk} + iy_{jk}$  and used Sylvester's criterion), and its boundary



is defined by the equation  $y_{11}y_{22} = \frac{1}{4}|z_{12} - \bar{z}_{21}|^2$ ; the skeleton is the real three-dimensional plane  $y_{11} = y_{22} = 0$ ,  $z_{12} = \bar{z}_{21}$ .

We remark that the nondegenerate affine transformation

$$Z \rightarrow \begin{pmatrix} z_{11} + z_{22} & z_{12} + z_{21} \\ i(z_{21} - z_{12}) & z_{11} - z_{22} \end{pmatrix} \quad (10)$$

maps  $H$  into the domain defined by the inequalities  $y_{11} > 0$  and  $y_{11}^2 - y_{22}^2 - y_{12}^2 - y_{21}^2 > 0$ , i.e., into the tube domain  $T = \mathbb{R}^4(x) + iC$  over the cone  $C = \{y_{11}^2 - y_{22}^2 - y_{12}^2 - y_{21}^2 > 0\}$ , or more precisely, over the one nappe  $C_+$  of this cone, for which  $y_{11} > 0$ . The boundary  $\partial H$  goes to  $\partial C_+ \times \mathbb{R}^4(x)$  under this transformation, and the skeleton goes to the real subspace  $\mathbb{R}^4(x)$ , more precisely to the product of this space by the vertex of the cone  $C_+$ .

## §2. Holomorphic functions

**3. The concept of holomorphy.** The concept of holomorphy for several variables generalizes the corresponding concept for the case of one variable (see Part I).

**DEFINITION 1.** A function  $l: \mathbb{C}^n \rightarrow \mathbb{C}$  is said to be  $\mathbb{R}$ -linear (respectively  $\mathbb{C}$ -linear) if:

- (a)  $l(z' + z'') = l(z') + l(z'')$  for all  $z', z'' \in \mathbb{C}^n$ ,
- (b)  $l(\lambda z) = \lambda l(z)$  for all  $z \in \mathbb{C}^n$  and all  $\lambda \in \mathbb{R}$  (respectively all  $\lambda \in \mathbb{C}$ ).

Any  $\mathbb{R}$ -linear function in  $\mathbb{C}^n$  has the form

$$l(z) = \sum_{\nu=1}^n (a_\nu z_\nu + b_\nu \bar{z}_\nu), \quad a_\nu, b_\nu \in \mathbb{C}, \quad (1)$$

and any  $\mathbb{C}$ -linear function has the form

$$l(z) = \sum_{\nu=1}^n a_\nu z_\nu, \quad a_\nu \in \mathbb{C}. \quad (2)$$

An  $\mathbb{R}$ -linear function  $l$  is  $\mathbb{C}$ -linear if and only if

$$l(iz) = il(z) \quad (3)$$

(cf. the corresponding assertion in subsection 6 in Part I).

**DEFINITION 2.** A function  $f: U \rightarrow \mathbb{C}$ , where  $U$  is a neighborhood of a point  $z \in \mathbb{C}^n$ , is said to be  $\mathbb{R}$ -differentiable (respectively,  $\mathbb{C}$ -differentiable) at  $z$  if

$$f(z + h) = f(z) + l(h) + o(h), \quad (4)$$

where  $l$  is some  $\mathbb{R}$ -linear (respectively  $\mathbb{C}$ -linear) function, and  $o(h)/|h| \rightarrow 0$  as  $h \rightarrow 0$ .

The function  $l$  is called the *differential* of  $f$  at  $z$  and is denoted by the symbol  $df$ . Setting  $h = dz = dx + idy$ , where  $dz = (dz_1, \dots, dz_n)$  is a complex vector and  $dx = (dx_1, \dots, dx_n)$  and  $dy = (dy_1, \dots, dy_n)$

are real vectors, we can, in the general case of  $\mathbb{R}$ -differentiability, write the differential in the form

$$df = \sum_{\nu=1}^n \left( \frac{\partial f}{\partial x_{\nu}} dx_{\nu} + \frac{\partial f}{\partial y_{\nu}} dy_{\nu} \right)$$

or, after passing to complex coordinates, in the form

$$df = \sum_{\nu=1}^n \left( \frac{\partial f}{\partial z_{\nu}} dz_{\nu} + \frac{\partial f}{\partial \bar{z}_{\nu}} d\bar{z}_{\nu} \right), \quad (5)$$

where we have introduced the notations

$$\begin{aligned} \frac{\partial f}{\partial z_{\nu}} &= \frac{1}{2} \left( \frac{\partial f}{\partial x_{\nu}} - i \frac{\partial f}{\partial y_{\nu}} \right), \\ \frac{\partial f}{\partial \bar{z}_{\nu}} &= \frac{1}{2} \left( \frac{\partial f}{\partial x_{\nu}} + i \frac{\partial f}{\partial y_{\nu}} \right), \end{aligned} \quad \nu = 1, \dots, n. \quad (6)$$

The first sum in (5) is denoted by the symbol  $\partial f$  and the second by the symbol  $\bar{\partial} f$ , so that

$$\partial = \sum_{\nu=1}^n \frac{\partial}{\partial z_{\nu}} dz_{\nu}, \quad \bar{\partial} = \sum_{\nu=1}^n \frac{\partial}{\partial \bar{z}_{\nu}} d\bar{z}_{\nu}, \quad d = \partial + \bar{\partial}. \quad (7)$$

**THEOREM 1.** *For a function  $f$  that is  $\mathbb{R}$ -differentiable at a point  $z \in \mathbb{C}^n$  to be  $\mathbb{C}$ -differentiable at  $z$  it is necessary and sufficient that the Cauchy-Riemann conditions*

$$\bar{\partial} f = 0 \quad (8)$$

hold.

◀ We see from (5) that  $df(ih) = i\partial f(h) - i\bar{\partial} f(h)$  and  $idf(h) = i\partial f(h) + i\bar{\partial} f(h)$ . Therefore the condition of  $\mathbb{C}$ -differentiability  $df(ih) = idf(h)$  is equivalent to the condition  $\bar{\partial} f(h) = 0$  for all  $h \in \mathbb{C}^n$ . ▶

The Cauchy-Riemann conditions (8) are equivalent to a system of  $n$  complex equations

$$\frac{\partial f}{\partial \bar{z}_{\nu}} = \frac{1}{2} \left( \frac{\partial f}{\partial x_{\nu}} + i \frac{\partial f}{\partial y_{\nu}} \right) = 0, \quad \nu = 1, \dots, n, \quad (9)$$

or the equivalent system of  $2n$  real equations

$$\frac{\partial u}{\partial x_{\nu}} = \frac{\partial v}{\partial y_{\nu}}, \quad \frac{\partial u}{\partial y_{\nu}} = -\frac{\partial v}{\partial x_{\nu}}, \quad \nu = 1, \dots, n, \quad (10)$$

where  $u = \operatorname{Re} f$  and  $v = \operatorname{Im} f$ . For  $n > 1$  this system is overdetermined (contains  $2n$  equations relative to two unknown functions) and this circumstance is a principal difference of multidimensional complex analysis from the one-dimensional theory.

**DEFINITION 3.** A function  $f$  is said to be *holomorphic at a point*  $z \in \mathbb{C}^n$  if it is  $\mathbb{C}$ -differentiable in some neighborhood of this point. On an open set the concepts of  $\mathbb{C}$ -differentiability and holomorphy are the same.

We remark that in the definition of holomorphy on an arbitrary (not necessarily open) set  $M$  there is a subtlety, which is seen from the following example.

EXAMPLE. Suppose the set  $M \subset \mathbb{C}^2$  consists of two closed balls  $\bar{B}_1 = \{|z - (0, 1)| \leq 1/2\}$  and  $\bar{B}_2 = \{|z + (0, 1)| \leq 1/2\}$ , joined by the line segment  $L = \{z_1 = 0, z_2 = x_2, |x_2| \leq 1/2\}$ . On  $M$  we define the function

$$f(z) = \begin{cases} z_1, & z \in \bar{B}_1, \\ 0, & z \in L, \\ -z_1, & z \in \bar{B}_2. \end{cases}$$

It is obviously continuous on  $M$ , and for each point  $z^0 \in M$  one can construct a neighborhood  $U_{z^0}$  into which  $f$  extends as a holomorphic function. In fact, for any point of  $\bar{B}_1$ , including the point  $(0, 1/2)$  of intersection of  $\bar{B}_1$  and  $L$ , we can take as such neighborhoods balls that do not intersect  $\bar{B}_2$ , and extend  $f$  into them by setting it equal to  $z_1$ . For points of  $\bar{B}_2$  we make an analogous construction, only we set  $f(z) = -z_1$ . Finally, for interior points of  $L$  we take balls that do not contain the ends of this line segment and set  $f = 0$  in them. However, from the uniqueness theorem that we shall prove in subsection 5, it follows that  $f$  cannot be extended to a holomorphic function in any connected neighborhood  $\Omega$  of the whole set  $M$ . In fact, it follows from this theorem that there does not exist a function that is holomorphic in  $\Omega$  that is equal to  $z_1$  in one ball from  $\Omega$  and to  $-z_1$  in the other.

From this example we see that it is necessary to distinguish functions that are *locally holomorphic* on a set, i.e., functions that can be extended locally to a holomorphic function at each point of the set, and *globally holomorphic* functions, which extend to functions that are holomorphic in a neighborhood of the whole set. Later on, as a rule, in speaking about the holomorphy of a function on a set, we shall have global holomorphy in mind.

The sum and product of functions that are holomorphic at a point  $z \in \mathbb{C}^n$  are also holomorphic at this point, so that the set of all functions holomorphic at the point  $z$  forms a ring, which is denoted by the symbol  $\mathcal{O}_z$ . The ring of functions that are holomorphic in a domain  $D \subset \mathbb{C}^n$  is denoted by the symbol  $\mathcal{O}(D)$ .

From the Cauchy-Riemann conditions (9) we see that a function  $f$  that is holomorphic in a neighborhood  $U \subset \mathbb{C}^n$  of the point  $z^0$  is holomorphic with respect to each variable  $z_\nu$  for fixed remaining variables (in a neighborhood of the point  $z_\nu^0$  on the complex line  $\{z: z_\mu = z_\mu^0, \mu \neq \nu\}$ ). Further, since the system (9) splits into equations in each of which the derivative with respect to only one of the variables occurs, it seems that the condition of holomorphy with respect to a set of variables does not impose any constraints on the dependence on the remaining variables. However, some constraint is nevertheless established: it turns out that a function that is holomorphic in  $U$  with respect to each variable  $z_\nu$  separately is certainly  $\mathbb{R}$ -differentiable with respect to all the variables jointly and then by Theorem 1 is holomorphic in  $U$ .

This fact forms the content of the so-called fundamental theorem of Hartogs<sup>(4)</sup> and is far from being trivial. For example, its real analogue is false:

<sup>(4)</sup>F. Hartogs (1874–1943) published a proof of this theorem in 1906.

the function

$$f(x, y) = \frac{xy}{x^2 + y^2}, \quad f(0, 0) = 0$$

is differentiable with respect to  $x$  for any fixed  $y$  and with respect to  $y$  for any fixed  $x$ , but is not even continuous at the point  $(0, 0) \in \mathbb{R}^2$ . We shall prove Hartogs's theorem in subsection 6.

**4. Pluriharmonic functions.** We start with a simple remark: if the function  $f = u + iv$  is holomorphic at a point  $z \in \mathbb{C}^n$ , then the function  $\bar{f} = u - iv$  is  $\mathbb{R}$ -differentiable in a neighborhood of this point and, for any  $\nu = 1, \dots, n$ ,

$$\frac{\partial \bar{f}}{\partial z_\nu} = \frac{1}{2} \left( \frac{\partial \bar{f}}{\partial x_\nu} - i \frac{\partial \bar{f}}{\partial y_\nu} \right) = \overline{\left( \frac{\partial f}{\partial \bar{z}_\nu} \right)} = 0 \quad (1)$$

there. Such functions  $\bar{f}$  are termed *antiholomorphic* at the point  $z$ .

Suppose  $f$  is holomorphic at a point  $z \in \mathbb{C}^n$ . Then by the preceding remark we have  $\partial u / \partial z_\nu = \frac{1}{2} \partial f / \partial z_\nu$  for its real part  $u = \frac{1}{2}(f + \bar{f})$  in a neighborhood of  $z$ . We will also use the fact that the partial derivatives of a holomorphic function are also holomorphic (this will be proved in subsection 5). It follows from this that, for any  $\mu, \nu = 1, \dots, n$ ,

$$\frac{\partial^2 u}{\partial z_\mu \partial \bar{z}_\nu} = \frac{\partial}{\partial \bar{z}_\nu} \left( \frac{\partial u}{\partial z_\mu} \right) = 0. \quad (2)$$

Separating the real and imaginary parts of the operator in the left-hand side of (2):

$$\frac{\partial}{\partial \bar{z}_\mu} \frac{\partial}{\partial z_\nu} = \frac{1}{4} \left( \frac{\partial^2}{\partial x_\mu \partial x_\nu} + \frac{\partial^2}{\partial y_\mu \partial y_\nu} \right) + \frac{i}{4} \left( \frac{\partial^2}{\partial x_\mu \partial y_\nu} - \frac{\partial^2}{\partial x_\nu \partial y_\mu} \right),$$

we find that condition (2) splits into  $n^2$  second-order partial differential equations:

$$\frac{\partial^2 u}{\partial x_\mu \partial x_\nu} + \frac{\partial^2 u}{\partial y_\mu \partial y_\nu} = 0, \quad \frac{\partial^2 u}{\partial x_\mu \partial y_\nu} - \frac{\partial^2 u}{\partial x_\nu \partial y_\mu} = 0 \quad (3)$$

( $\mu, \nu = 1, \dots, n$ ; the equations of the second group are trivial for  $\mu = \nu$ ).

If we use the operators  $\partial$  and  $\bar{\partial}$  introduced in (7) of subsection 3, then the system (2) can be rewritten as a single condition

$$\bar{\partial} \partial u = 0. \quad (4)$$

**DEFINITION.** A function  $u$  of class  $C^2$  in a domain  $D \subset \mathbb{C}^n$  that satisfies the condition (4) at each point of  $D$  is said to be *pluriharmonic* in  $D$ .

\* 1. Prove that a function  $u \in C^2(D)$  is pluriharmonic if and only if its restriction to the complex line  $\{z = z^0 + \omega \zeta\}$ , i.e., the function  $h(\zeta) = u(z^0 + \omega \zeta)$ , is harmonic on the open set  $\{\zeta \in \mathbb{C} : z^0 + \omega \zeta \in D\}$ .

2. If the restriction of  $u \in C^2$  to any real two-dimensional plane  $\{z = z^0 + \omega \zeta + \omega' \bar{\zeta}\}$  is harmonic, then  $u$  is a linear function. \*

Pluriharmonic functions are connected with holomorphic functions of several variables in the same way that harmonic functions (in  $\mathbb{R}^2$ ) are connected with holomorphic functions of one variable. Namely, we have the following two theorems:

**THEOREM 1.** *The real and imaginary parts of a function  $f$  that are holomorphic in a domain  $D \subset \mathbb{C}^n$  are pluriharmonic in  $D$ .*

◀ For the real part  $u = \operatorname{Re} f$  the theorem has already been proved. Since if  $f \in \mathcal{O}(D)$ , so is  $-if$ , and since  $\operatorname{Im} f = \operatorname{Re}(-if)$ , the theorem also holds for the imaginary part of  $f$ . ▶

The converse is also true, but generally only locally.

**THEOREM 2.** *For any function  $u$  that is pluriharmonic in a neighborhood  $U$  of the point  $(x^0, y^0) \in \mathbb{R}^{2n}$ , there exists a function  $f$ , holomorphic at  $z^0 = x^0 + iy^0$ , whose real (or imaginary) part is equal to  $u$ .*

◀ Instead of

$$du = \sum \left( \frac{\partial u}{\partial x_\nu} dx_\nu + \frac{\partial u}{\partial y_\nu} dy_\nu \right)$$

we consider the so-called conjugate differential

$$*du = \sum_{\nu=1}^n \left( -\frac{\partial u}{\partial y_\nu} dx_\nu + \frac{\partial u}{\partial x_\nu} dy_\nu \right). \quad (5)$$

The form<sup>(5)</sup>  $\omega = *du$  is closed in  $U$ , since, because  $u$  is pluriharmonic, its coefficients are of class  $C^1$  and

$$\begin{aligned} d\omega &= \sum_{\mu, \nu=1}^n \left( \frac{\partial^2 u}{\partial x_\nu \partial y_\mu} - \frac{\partial^2 u}{\partial x_\mu \partial y_\nu} \right) (dx_\mu \wedge dx_\nu + dy_\mu \wedge dy_\nu) \\ &+ \sum_{\mu, \nu=1}^n \left( \frac{\partial^2 u}{\partial x_\mu \partial x_\nu} + \frac{\partial^2 u}{\partial y_\mu \partial y_\nu} \right) dx_\mu \wedge dy_\nu = 0 \end{aligned}$$

by (3). But every closed form is locally exact, so that in a neighborhood of  $z^0$  there is a function  $v$  such that  $*du = dv$ : it is expressed by the integral

$$v(z) = \int_{z^0}^z *du, \quad (6)$$

which does not depend on the path since  $*du$  is closed. But then in a neighborhood of  $z^0$

$$\frac{\partial v}{\partial x_\nu} = -\frac{\partial u}{\partial y_\nu}, \quad \frac{\partial v}{\partial y_\nu} = \frac{\partial u}{\partial x_\nu},$$

and consequently the function  $f = u + iv$  is of class  $C^2$  and satisfies the Cauchy-Riemann equations of the preceding subsection; by Theorem 1 of subsection 3 it is holomorphic at  $z^0$  and  $u = \operatorname{Re} f$ .

<sup>(5)</sup>Readers not familiar with differential forms should turn to subsection 14.

The function  $if = iu - v$ , which is holomorphic at  $z^0$ , has  $u$  as its imaginary part. ►

For  $\mu = \nu$  the first set of equations of (3) gives

$$\frac{\partial^2 u}{\partial x_\nu^2} + \frac{\partial^2 u}{\partial y_\nu^2} = 0. \quad (7)$$

Adding these equations for  $\nu = 1, \dots, n$ , we will find that the Laplacian of the function  $u$  with respect to the variables  $x_1, y_1, \dots, x_n, y_n$  satisfies

$$\Delta u = \sum_{\nu=1}^n \left( \frac{\partial^2 u}{\partial x_\nu^2} + \frac{\partial^2 u}{\partial y_\nu^2} \right) = 0. \quad (8)$$

Consequently, *pluriharmonic functions form a subclass of the class of harmonic functions* in the space  $\mathbb{R}^{2n}$  (obviously proper for  $n > 1$ ).

There naturally arises the question of the determination of a pluriharmonic function in a domain  $D \subset \mathbb{R}^{2n}$  from given boundary values (Dirichlet problem). This question is not solved as simply as in the case of harmonic functions. We illustrate the difficulties that arise using the example of one of the simplest domains, the polydisc  $U = \{z \in \mathbb{C}^n : |z_\nu| < 1\}$ . Since, by (7), a pluriharmonic function is harmonic with respect to each variable  $z_\nu = x_\nu + iy_\nu$  in the disc  $\{|z_\nu| < 1\}$ , we can successively apply the Poisson integral from subsection 2 of the Appendix to Part I. For any  $z \in U$  we obtain

$$u(z) = \int_0^{2\pi} P(\zeta_1, z_1) dt_1 \cdots \int_0^{2\pi} u(\zeta) P(\zeta_n, z_n) dt_n,$$

where  $\zeta_\nu = e^{it_\nu}$ ,  $\zeta = (\zeta_1, \dots, \zeta_n)$ , and

$$P(\zeta_\nu, z_\nu) = \frac{1}{2\pi} \frac{1 - |z_\nu|^2}{|\zeta_\nu - z_\nu|^2}$$

is the Poisson kernel. Denoting by

$$P_n(\zeta, z) = \prod_{\nu=1}^n P(\zeta_\nu, z_\nu) \quad (9)$$

the  $n$ -dimensional Poisson kernel, by  $Q_n = [0, 2\pi] \times \cdots \times [0, 2\pi]$  ( $n$  times) the  $n$ -dimensional cube, and by  $dt = dt_1 \cdots dt_n$  the volume element, we rewrite the Poisson integral formula in the following abbreviated form:

$$u(z) = \int_{Q_n} u(\zeta) P_n(\zeta, z) dt. \quad (10)$$

The right-hand side of this formula includes only the values of  $u$  on the SKELETON  $\Gamma$  of the polydisc, i.e., on the  $n$ -dimensional part of the boundary  $\partial U$  (the entire boundary is  $(2n - 1)$ -dimensional). From this it is clear that one cannot arbitrarily give the values of a pluriharmonic function  $u$  on the whole boundary of the polydisc. If in the right-hand side of (10) we substitute

the values of some function  $u(\zeta)$  that is continuous on  $\Gamma$ , then the function  $u(z)$  defined in  $U$  by this formula will, as is not hard to check, satisfy the equations (7) for all  $\nu = 1, \dots, n$ . However, this function will not in general satisfy the other equations of (3), i.e., will not be pluriharmonic in  $U$ . For  $u(z)$  to be pluriharmonic it is necessary to impose additional conditions on the values  $u(\zeta)$ , which we shall not discuss further.

**5. Simplest properties of holomorphic functions.** Here we establish a number of elementary properties of holomorphic functions of several variables that are analogous to properties of functions of one variable. For brevity we shall denote by  $U = \{z \in \mathbb{C}^n: |z_\nu - a_\nu| < r_\nu, \nu = 1, \dots, n\}$  the polydisc with center  $a$  and vector radius  $r = (r_1, \dots, r_n)$ . We denote by  $\mathcal{O}(U) \cap C(\bar{U})$  the set of functions that are holomorphic in  $U$  and continuous in  $\bar{U}$ .

**THEOREM 1.** *Any function  $f \in \mathcal{O}(U) \cap C(\bar{U})$  at any point  $z \in U$  is represented by a multiple Cauchy integral*

$$f(z) = \frac{1}{(2\pi i)^n} \int_{\Gamma} \frac{f(\zeta) d\zeta_1 \cdots d\zeta_n}{(\zeta_1 - z_1) \cdots (\zeta_n - z_n)}, \quad (1)$$

where  $\Gamma$  is the skeleton of  $U$ , i.e., the product of the boundary circles  $\gamma_\nu = \{|z_\nu - a_\nu| = r_\nu\}$ ,  $\nu = 1, \dots, n$ .

◀ Let  $'z$  and  $'U$  be the projections of  $z$  and  $U$  into  $\mathbb{C}^{n-1}$ ; since for any  $'z \in 'U$  the function  $f(z) = f('z, z_n)$  is holomorphic in  $z_n$  in the disc  $\{|z_n - a_n| < r_n\}$  and is continuous in its closure, then by the Cauchy integral formula from Part I

$$f(z) = \frac{1}{2\pi i} \int_{\gamma_n} \frac{f('z, \zeta_n)}{\zeta_n - z_n} d\zeta_n.$$

For any  $\zeta_n \in \gamma_n$  and any  $'z \in 'U$  the integrand can be represented by a Cauchy integral in the variable  $z_{n-1}$ , and since  $f$  is continuous in the set of all variables the repeated integral can be represented as a multiple integral over the product  $\gamma_{n-1} \times \gamma_n$ . Continuing this argument, we arrive at (1). ▶

In what follows we shall write formula (1) in the abbreviated form:

$$f(z) = \frac{1}{(2\pi i)^n} \int_{\Gamma} \frac{f(\zeta) d\zeta}{\zeta - z'}, \quad (2)$$

where  $d\zeta = d\zeta_1 \cdots d\zeta_n$  and  $1/(\zeta - z) = 1/((\zeta_1 - z_1) \cdots (\zeta_n - z_n))$ .

**REMARK.** As we see from the proof of Theorem 1, in order for a function  $f$  to be representable by a multiple Cauchy integral (1) it is sufficient for  $f$  to be holomorphic in each variable  $z_\nu$  in the disc  $\{|z_\nu - a_\nu| < r_\nu\}$  and continuous with respect to the set of all variables in  $\bar{U}$ .

As in the case of one variable (Part I), from the Cauchy integral representation of a function we deduce the possibility of expanding it in a power series. For this we expand the kernel of the integral (2) in a multiple geometric

progression:

$$\begin{aligned} \frac{1}{\zeta - z} &= \frac{1}{\zeta - a} \cdot \frac{1}{\left(1 - \frac{z_1 - a_1}{\zeta_1 - a_1}\right) \cdots \left(1 - \frac{z_n - a_n}{\zeta_n - a_n}\right)} \\ &= \frac{1}{\zeta - a} \sum_{|k|=0}^{\infty} \left(\frac{z - a}{\zeta - a}\right)^k, \end{aligned}$$

where  $k = (k_1, \dots, k_n)$  is an integer vector,  $|k| = k_1 + \dots + k_n$ , and

$$\left(\frac{z - a}{\zeta - a}\right)^k = \left(\frac{z_1 - a_1}{\zeta_1 - a_1}\right)^{k_1} \cdots \left(\frac{z_n - a_n}{\zeta_n - a_n}\right)^{k_n}.$$

This expansion can be rewritten in the form

$$\frac{1}{\zeta - z} = \sum_{|k|=0}^{\infty} \frac{(z - a)^k}{(\zeta - a)^{k+1}},$$

where  $k+1 = (k_1+1, \dots, k_n+1)$ ; for any  $z \in U$  it converges absolutely and uniformly in  $\zeta$  on  $\Gamma$ . Multiplying it by the continuous (and hence bounded) function  $f(\zeta)/(2\pi i)^n$  on  $\Gamma$  and integrating term-by-term over  $\Gamma$ , we will obtain the desired assertion:

**THEOREM 2.** *If  $f \in \mathcal{O}(U) \cap C(\bar{U})$ , then at each point  $z \in U$  it is represented as a multiple power series*

$$f(z) = \sum_{|k|=0}^{\infty} c_k (z - a)^k \quad (3)$$

with coefficients

$$c_k = \frac{1}{(2\pi i)^n} \int_{\Gamma} \frac{f(\zeta) d\zeta}{(\zeta - a)^{k+1}}. \quad (4)$$

**REMARK.** Any function  $f \in \mathcal{O}(U)$  can be represented as the sum of a series (3) at each point  $z \in U$ . For the proof it suffices to remark that the point  $z$  belongs to some polydisc  $U' \subset\subset U$  and to apply Theorem 2 to  $U'$ .

**LEMMA (Abel).** *If the terms of the multiple power series  $\sum_{|k|=0}^{\infty} c_k (z - a)^k$  are bounded at some point  $\zeta \in \mathbb{C}^n$ , then it converges absolutely and uniformly on any compact subset  $K$  of the polydisc  $U(a, \rho)$  with center  $a$  and vector radius  $\rho = (\rho_1, \dots, \rho_n)$ , where  $\rho_\nu = |\zeta_\nu - a_\nu|$ .*

◀ Let  $|c_k(\zeta - a)^k| = |c_k| \rho^k \leq M$ , where  $\rho^k = \rho_1^{k_1} \cdots \rho_n^{k_n}$ , and we may assume that all the  $\rho_\nu > 0$  (otherwise  $K$  is empty). From the condition  $K \subset\subset U(a, \rho)$  it follows that

$$q_\nu = \max_{z \in K} \frac{1}{\rho_\nu} |z_\nu - a_\nu| < 1 \quad (\nu = 1, \dots, n),$$

and therefore at any point  $z \in K$  we have  $|c_k(z - a)^k| \leq |c_k| \rho^k q^k \leq M q^k$ , where  $q^k = q_1^{k_1} \cdots q_n^{k_n}$ . It remains to notice that the multiple geometric progression  $\sum M q^k$  converges, since all the  $q_\nu < 1$ . ▶



**THEOREM 3.** *If  $f \in \mathcal{O}(U)$ , then at any point  $z \in U$  this function has partial derivatives of all orders that also belong to  $\mathcal{O}(U)$ .*

◀ By Theorem 2 at any point  $z \in U$  the function  $f$  is represented as the sum of a power series (3). Using the possibility of rearranging the terms of the series, which follows from Abel's lemma and also the results of Part I concerning the one-variable case, we shall prove that  $f$  has partial derivatives of all orders that are representable by series and are obtained by the corresponding term-by-term differentiation of the series (3).

Since by Abel's lemma these series converge uniformly on compact subsets of  $U$ , and their terms are continuous with respect to all the variables jointly, then any of the derivatives is  $\mathbb{R}$ -differentiable in  $U$  and therefore since this derivative is holomorphic in each variable it is holomorphic in  $U$ . ▶

**REMARK.** Suppose the function  $f$  is continuous in  $\bar{U}$  and is holomorphic with respect to each variable. Then it can be represented by a Cauchy integral (see the remark following Theorem 1), and then by Theorem 2 also by a power series. From the proof of Theorem 3 we see that the function  $f$  is  $\mathbb{C}$ -differentiable, and hence, is also holomorphic in  $U$ . Thus, in order to prove the fundamental theorem of Hartogs that we talked about in subsection 3 it suffices to prove that if  $f$  is holomorphic in each variable separately in  $\bar{U}$  then it is continuous in  $\bar{U}$ .

In the usual way one proves the theorem on the unique expansion of a function in a power series with a given center:

**THEOREM 4.** *If a function  $f$  that is holomorphic at a point  $a$  is expanded in a power series of the form (3), then the coefficients of this series are defined by Taylor's formulas:*

$$c_k = \frac{1}{k_1! \cdots k_n!} \frac{\partial^{k_1 + \cdots + k_n} f}{\partial z_1^{k_1} \cdots \partial z_n^{k_n}} \Big|_{z=a} = \frac{1}{k!} \frac{\partial^{|k|} f}{\partial z^k} \Big|_{z=a}, \quad (5)$$

where  $k! = k_1! \cdots k_n!$ .

Using the formulas (4) for the same coefficients and estimating the integrals in (4), we obtain

**CAUCHY'S INEQUALITIES.** *If the function  $f \in \mathcal{O}(U) \cap C(\bar{U})$  and  $|f| \leq M$  on the skeleton  $\Gamma$ , then the Taylor coefficients of the expansion of  $f$  at the point  $a$  satisfy the inequalities*

$$|c_k| \leq M/r^k, \quad (6)$$

where  $r^k = r_1^{k_1} \cdots r_n^{k_n}$ .

The uniqueness theorem in the formulation from subsection 22 of Part I does not extend to the higher-dimensional case: the function  $z_1 z_2$  is holomorphic in  $\mathbb{C}^2$  and is not identically equal to zero, but it vanishes on a set with limit points (on the complex lines  $\{z_1 = 0\}$  and  $\{z_2 = 0\}$ ). However, the following theorem is true.

**THEOREM 5 (uniqueness).** *If the function  $f \in \mathcal{O}(D)$  vanishes at some point  $a$  in the domain  $D \subset \mathbb{C}^n$  together with all its partial derivatives, then  $f \equiv 0$  in  $D$ .*

◀ All the coefficients in the Taylor expansion of  $f$  at  $a$  are equal to 0, and hence  $f \equiv 0$  in some neighborhood of  $a$ . We denote  $E = \{z \in D : f(z) = 0\}$  and by  $\overset{\circ}{E}$  the interior of  $E$ . The set  $\overset{\circ}{E}$  is open and nonempty (it contains  $a$ ); since all the derivatives of  $f$  are continuous, this set is also closed in  $D$ . Therefore  $\overset{\circ}{E} = D$ . ▶

In this theorem we have essentially required that  $f$  should vanish in a  $2n$ -dimensional neighborhood of the point  $a$ . Even from its vanishing in a  $(2n - 2)$ -dimensional neighborhood of a point the identical vanishing of the function does not follow (example:  $f(z) = z_n$  vanishes on the  $(2n - 2)$ -dimensional set  $\{z \in \mathbb{C}^n : z_n = 0\}$ ). However, there are cases when the vanishing of a function in an  $n$ -dimensional neighborhood of a point implies that it is identically equal to zero:

*If the function  $f \in \mathcal{O}(D)$  vanishes in a real neighborhood of a point  $a \in D$ , i.e., on the set  $\{z = x + iy \in \mathbb{C}^n : |x - x^0| < r, y = y^0\}$ , then  $f \equiv 0$  in  $D$ .*

◀ In some polydisc with center  $z^0$  the function  $f$  has the series expansion

$$f(z) = \sum_{|k|=0}^{\infty} c_k (z - z^0)^k.$$

Setting  $y = y^0$  here, we will find that

$$\sum_{|k|=0}^{\infty} c_k (x - x^0)^k \equiv 0$$

for all  $x \in \{|x - x^0| < r\}$ . Differentiating this identity with respect to  $x^k = x_1^{k_1} \dots x_n^{k_n}$ , and then setting  $x = x^0$ , we will find that all the  $c_k = 0$ . Then by Theorem 5  $f \equiv 0$  in  $D$ . ▶

**THEOREM 6 (maximum modulus principle).** *If  $f \in \mathcal{O}(D)$  and  $|f|$  attains a maximum at some point  $a \in D$ , then  $f \equiv \text{const}$  in  $D$ .*

◀ We consider an arbitrary complex line  $l(\zeta) = a + \omega\zeta$  that passes through  $a$ . The restriction of  $f$  to this line, the function  $\varphi_\omega(\zeta) = f \circ l(\zeta)$ , is holomorphic in some disc  $\{|\zeta| < \rho\}$ , and  $|\varphi_\omega|$  attains a maximum for  $\zeta = 0$ . By the maximum modulus principle for one variable  $\varphi_\omega(\zeta) = c(\omega)$  is a constant depending on  $\omega$ . But  $\varphi_\omega(0) = f(a)$  does not depend on  $\omega$ ; therefore  $c(\omega) = \text{const}$  and  $f = \text{const}$  in a neighborhood of  $a$ . By Theorem 5,  $f = \text{const}$  in  $D$ . ▶

If  $f$  is holomorphic in a domain  $D \subset \mathbb{C}^n$  and continuous in  $\bar{D}$ , then the maximum of  $|f|$  is attained on the boundary  $\partial D$ . However in  $\mathbb{C}^n$  for  $n > 1$  there exist domains in which  $\max|f|$ , for any  $f \in \mathcal{O}(D)$ , continuous

in  $\bar{D}$ , is actually attained not on all of  $\partial D$ , but only on some subset of it. The smallest such closed subset is called the *Shilov boundary*<sup>(6)</sup> of the domain  $D$ . More precisely, the Shilov boundary of a domain  $D$  is a closed set  $S \subset \partial D$  such that: (1) for any  $f \in \mathcal{O}(D)$ , continuous in  $\bar{D}$ ,

$$\max_{z \in \bar{D}} |f(z)| = \max_{z \in S} |f(z)|, \quad (7)$$

and (2) any closed set  $\tilde{S}$  that possesses property (1) contains  $S$ .

EXAMPLES.

1. The BALL  $B = \{z \in \mathbb{C}^n : |z| < 1\}$ . We shall show that here the Shilov boundary coincides with the topological boundary. For this we take an arbitrary point  $\zeta \in \partial B$  and construct a function  $f$ , holomorphic in  $B$ , continuous in  $\bar{B}$ , and such that  $|f(\zeta)| > |f(z)|$  for all  $z \in \bar{B} \setminus \{\zeta\}$ . For the Hermitian scalar product  $(z, \zeta)$  by the Cauchy-Bunyakovskii inequality we have  $\operatorname{Re}(z, \zeta) \leq |(z, \zeta)| \leq |z|$ , since  $|\zeta| = 1$ , and the equality  $\operatorname{Re}(z, \zeta) = |z| = 1$  is attained only for  $z = \zeta$ . Therefore the function  $f(z) = e^{(z, \zeta)}$  possesses the desired property.

2. The POLYDISC  $U = \{z \in \mathbb{C}^n : \|z\| < 1\}$ . Here the Shilov boundary forms only an  $n$ -dimensional part of the  $(2n-1)$ -dimensional topological boundary, namely, it coincides with the skeleton of the polydisc. To prove this we consider an arbitrary function  $f$ , holomorphic in  $U$  and continuous in  $\bar{U}$ . First of all we note that the function  $f'(z, \zeta_n)$ , for any fixed  $\zeta_n$ ,  $|\zeta_n| = 1$ , is a holomorphic function in  $'z$  in the polydisc  $'U \subset \mathbb{C}^{n-1}$ . In fact, it can be represented as the limit of the sequence of functions  $\varphi_\mu('z) = f('z, z_n^{(\mu)})$ , where  $z_n^{(\mu)}$  is some sequence of points of the disc  $\{|z_n| < 1\}$  that converges to the point  $\zeta_n$ . Since  $('z, z_n^{(\mu)}) \in U$ , all the  $\varphi_\mu$  are holomorphic in  $'U$ , and in view of the uniform continuity of  $f$  in  $\bar{U}$  the sequence  $\varphi_\mu$  converges uniformly in  $'\bar{U}$ . By the theorem of Weierstrass (see Theorem 8 below) we obtain the desired assertion from this. In exactly the same way one proves that all the functions  $f(z_1, \dots, z_m, \zeta_{m+1}, \dots, \zeta_n)$ , where  $m = 1, \dots, n-1$  and fixed  $\zeta_{m+1}, \dots, \zeta_n$  equal to one in modulus, are holomorphic with respect to  $(z_1, \dots, z_m)$  in the corresponding polydiscs.

Suppose that  $M = \max_{z \in \bar{U}} |f(z)|$  is attained at some point  $\zeta \in \partial U$ , which belongs to one of the sets  $\Gamma^\nu = \{|\zeta_\nu| = 1, |\zeta_\mu| \leq 1 \text{ for } \mu \neq \nu\}$ ; renumbering the variables if necessary we may assume that this set is  $\Gamma^n$ . Either  $|\zeta_{n-1}| = 1$  or by the maximum modulus principle (it can be applied by what we just proved)  $f$  is constant with respect to the variable  $z_{n-1}$ , and then the value  $M$  is attained at some point whose last two coordinates are equal to 1. Continuing this argument, we find that the value  $M$  is attained on the skeleton  $\Gamma = \{|z_\nu| = 1, \nu = 1, \dots, n\}$  of the polydisc. Thus, the Shilov boundary of the polydisc  $U$  belongs to  $\Gamma$ .

But for any point  $\zeta \in \Gamma$  there is a function  $f$ , holomorphic in  $U$  and continuous in  $\bar{U}$ , for which  $|f(\zeta)| > |f(z)|$  for all  $z \in \bar{U} \setminus \{\zeta\}$ : we can take the product  $\prod_{\nu=1}^n (1 + \bar{\zeta}_\nu z_\nu)$  as such a function. Thus, the Shilov boundary of a polydisc coincides with its skeleton.

3. The TUBE DOMAIN  $T = \mathbb{R}^4(x) + iC_+$  over the cone  $C_+ = \{y \in \mathbb{R}^4 : y_{11}^2 > y_{12}^2 + y_{21}^2 + y_{22}^2, y_{11} > 0\}$ . As shown in Example 8 of subsection 2, this domain is equivalent to a generalized upper half-plane  $H$ . Its boundary  $\partial T = \{z = x + iy : x \in \mathbb{R}^4, y \in C_+\}$  fibers into complex half-lines  $\{z = x + \zeta y : (x, y) \in \partial T, \zeta \in \mathbb{C}, \operatorname{Im} \zeta \geq 0\}$ , and by the same argument as in the previous example, the maximum modulus of any function, holomorphic in  $T$  and continuous in  $\bar{T}$  (closure in  $\mathbb{C}^4$ ), is attained for  $\operatorname{Im} \zeta = 0$ , i.e., on the set  $\mathbb{R}^4(x) + i0$ , the skeleton of  $T$ . On the other hand, for any fixed point  $x^0 + i0$  there exists a function  $f(z) = (z_{11} - x_{11}^0 + i)^{-1} \cdots (z_{22} - x_{22}^0 + i)^{-1} \in \mathcal{O}(T) \cap C(\bar{T})$ , whose maximum modulus is attained at this point. Thus, the Shilov boundary of the domain  $T$  is also its skeleton.

<sup>(6)</sup>Georgii Evgen'evich Shilov (1917–1975) was a professor at Moscow University and a specialist in functional analysis.

**THEOREM 7 (Liouville).** *If the function  $f$  is holomorphic in  $\mathbb{C}^n$  and bounded, then it is constant.*

◀ As in Part I, this follows from Cauchy's inequalities. The function  $f$  admits a multiple power series expansion

$$f(z) = \sum_{|k|=0}^{\infty} c_k z^k,$$

which converges in any polydisc  $\{|z| < r\}$ . If  $|f(z)| \leq M$  everywhere, then for all  $r$  by Cauchy's inequalities (6), where  $r_1 = \dots = r_n = r$ , we have  $|c_k| \leq M/r^{|k|}$ . In the limit as  $r \rightarrow \infty$  we find that  $c_k = 0$  if  $|k| = k_1 + \dots + k_n > 0$ , i.e., that  $f(z) = c_0$ . ▶

**THEOREM 8 (Weierstrass).** *Suppose that a sequence of functions  $f_\mu \in \mathcal{O}(D)$  converges to a function  $f$  uniformly on each compact subset of  $D$ . Then  $f \in \mathcal{O}(D)$  and, for any  $k = (k_1, \dots, k_n)$ ,*

$$\frac{\partial^{|k|} f_\mu}{\partial z^k} \rightarrow \frac{\partial^{|k|} f}{\partial z^k} \quad (8)$$

on any  $K \subset\subset D$ .

◀ By the theorem of subsection 23 of Part I the function  $f$  is holomorphic with respect to each variable at any point  $z \in D$ , and since it is obviously continuous in  $D$  with respect to all the variables together, then by the remark following Theorem 3 it belongs to  $\mathcal{O}(D)$ . It suffices to prove the second part of the theorem for a neighborhood of an arbitrary point  $z^0 \in D$  and the derivative with respect to a single variable  $z_\nu$ . We take the polydisc  $U = U(z^0, r) \subset\subset D$  and use Cauchy's formula, according to which at any point  $z \in U$

$$\frac{\partial f_\mu}{\partial z_\nu} - \frac{\partial f}{\partial z_\nu} = \frac{1}{(2\pi i)^n} \int_{\Gamma} \frac{f_\mu(\zeta) - f(\zeta)}{(\zeta - z)(\zeta_\nu - z_\nu)} d\zeta, \quad (9)$$

where  $\Gamma$  is the skeleton of  $U$ . Since  $f_\mu \rightarrow f$  uniformly on  $\Gamma$ , it follows that for any  $\varepsilon > 0$  there is a  $\mu_0$  such that  $\|f_\mu - f\|_{\Gamma} < \varepsilon$  for all  $\mu \geq \mu_0$ . If  $K \subset\subset U$ , then from (9) we will have, for all  $z \in K$  and  $\mu \geq \mu_0$ ,

$$\left| \frac{\partial f_\mu}{\partial z_\nu} - \frac{\partial f}{\partial z_\nu} \right| < \frac{\varepsilon}{(2\pi)^n} \frac{(2\pi)^n r_1 \dots r_n}{\min_{z \in K, \zeta \in \Gamma} |\zeta - z| |\zeta_\nu - z_\nu|};$$

from this it follows that  $\partial f_\mu / \partial z_\nu \rightarrow \partial f / \partial z_\nu$  uniformly on  $K$ . ▶

To conclude this subsection we shall prove a lemma on the holomorphic dependence of integrals on a parameter.

**LEMMA.** *Let  $\gamma_\mu : \zeta_\mu = \zeta_\mu(t)$  be a rectifiable curve in the plane of  $\zeta_\mu$  ( $\mu = 1, \dots, m$ ),  $\gamma = \gamma_1 \times \dots \times \gamma_m$ , and  $D$  be a domain in  $\mathbb{C}^n$ ; let*

$\zeta = (\zeta_1, \dots, \zeta_m)$  and  $z = (z_1, \dots, z_n)$ . If the function  $g(\zeta, z)$  is continuous on  $\gamma \times D$ , holomorphic with respect to  $z$  in  $D$  for any  $\zeta \in \gamma$ , and has continuous partial derivatives  $\partial g/\partial z_\nu$  on  $\gamma \times D$ , then the integral

$$G(z) = \int_{\gamma_1} d\zeta_1 \cdots \int_{\gamma_m} g(\zeta, z) d\zeta_m = \int_{\gamma} g(\zeta, z) d\zeta \quad (10)$$

is holomorphic in  $D$  and

$$\frac{\partial G}{\partial z_\nu} = \int_{\gamma} \frac{\partial g(\zeta, z)}{\partial z_\nu} d\zeta, \quad \nu = 1, \dots, n. \quad (11)$$

◀ For any  $z \in D$  we choose an  $r > 0$  so that the polydisc  $U(z, r) \subset D$ ; let  $|h_\nu| < r$  and let  $h = (0, \dots, h_\nu, \dots, 0) \in \mathbb{C}^n$  be a vector for which all coordinates except the  $\nu$ th are equal to 0. We have

$$\begin{aligned} \frac{1}{h_\nu} \{G(z+h) - G(z)\} &= \frac{1}{h_\nu} \int_{\gamma} \{g(\zeta, z+h) - g(\zeta, z)\} d\zeta \\ &= \int_{\gamma} d\zeta \int_0^1 \frac{\partial g(\zeta, z+\theta h)}{\partial z_\nu} d\theta \end{aligned}$$

and hence

$$\begin{aligned} \frac{1}{h_\nu} \{G(z+h) - G(z)\} - \int_{\gamma} \frac{\partial g(\zeta, z)}{\partial z_\nu} d\zeta \\ = \int_{\gamma} d\zeta \int_0^1 \left\{ \frac{\partial g(\zeta, z+\theta h)}{\partial z_\nu} - \frac{\partial g(\zeta, z)}{\partial z_\nu} \right\} d\theta. \end{aligned} \quad (12)$$

Since, for fixed  $z$ ,  $\partial g(\zeta, z+\theta h)/\partial z_\nu$  is uniformly continuous on the compact set  $\gamma \times [0, 1]$ , then for any  $\varepsilon > 0$  we can choose a  $\delta > 0$  so small that for all  $(\zeta, \theta) \in \gamma \times [0, 1]$  for  $|h| < \delta$  we will have

$$\left| \frac{\partial g(\zeta, z+\theta h)}{\partial z_\nu} - \frac{\partial g(\zeta, z)}{\partial z_\nu} \right| < \varepsilon.$$

Therefore, estimating the integrals in the right-hand side of (12) successively, we will find that the left-hand side of (12) does not exceed  $\varepsilon|\gamma_1| \cdots |\gamma_m|$  in modulus for  $|h| < \delta$ . Thus, at each point  $z \in D$  the partial derivatives  $\partial G/\partial z_\nu$  exist and are expressed by the formulas (11). ▶

**6. The fundamental theorem of Hartogs.** Here we shall prove the theorem that if a function is holomorphic with respect to each variable separately, it is holomorphic with respect to the set of all the variables. We already discussed this theorem in subsection 3. In subsection 5 we established that in order to prove this theorem it suffices to prove that every function that is holomorphic with respect to each variable is continuous with respect to the set of all the variables.

We preface the proof with a number of lemmas. The first of them asserts that it suffices to establish only the boundedness of the function under consideration. Here we use the lemma of Schwarz in a somewhat more general form than in subsection 37 of Part I.

Suppose that the function  $\varphi$  is holomorphic in the disc  $U_r = \{ |z| < r \} \subset \mathbb{C}$ , where  $\varphi = 0$  at some point  $z_0 \in U_r$  and  $|\varphi| \leq M$  everywhere in  $U_r$ . Then everywhere in  $U_r$  we have the estimate

$$|\varphi(z)| \leq Mr \frac{|z - z_0|}{|r^2 - \bar{z}_0 z|} \quad (1)$$

(for  $r = M = 1$  and  $z_0 = 0$  we obtain the usual statement).

For the proof we take a linear-fractional mapping of  $U_r$  onto the unit disc  $U$ :

$$\lambda: z \rightarrow r \frac{z - z_0}{r^2 - \bar{z}_0 z},$$

we denote by  $\lambda^{-1}$  the inverse mapping  $U \rightarrow U_r$  and consider the function  $\psi = \frac{1}{M} \varphi \circ \lambda^{-1}$ . It satisfies the hypotheses of the usual Schwarz lemma, and by this lemma  $|\psi(z)| \leq |z|$  everywhere in  $U$ . Replacing  $z$  here by  $\lambda(z)$ , we obtain the inequality (1).

**LEMMA 1.** *If the function  $f$  is holomorphic with respect to each variable  $z_\nu$  in the polydisc  $U = U(a, r)$  <sup>(7)</sup> and bounded in  $U$ , then it is continuous at each point of  $U$  with respect to the set of all the variables.*

◀ Let  $z^0, z \in U$  be arbitrary points. We write the increment of  $f$  as a sum of the increments with respect to the individual coordinates

$$f(z) - f(z^0) = \sum_{\nu=1}^n \{ f(z_1^0, \dots, z_{\nu-1}^0, z_\nu, \dots, z_n) - f(z_1^0, \dots, z_\nu^0, z_{\nu+1}, \dots, z_n) \} \quad (2)$$

and consider the  $\nu$ th summand as a function  $\varphi_\nu$  of the variable  $z_\nu$  with the remaining values of the argument being fixed. If  $|f| \leq M/2$  in  $U$ , then the function  $\varphi_\nu$  satisfies the hypotheses of Schwarz's lemma in the form just given, and, applying inequality (1) to each term of the sum (2), we will find that

$$|f(z) - f(z^0)| \leq M \sum_{\nu=1}^n r_\nu \frac{|z_\nu - z_\nu^0|}{|r_\nu^2 - \bar{z}_\nu^0 z_\nu|}.$$

The assertion follows from this. ▶

Thus, to prove Hartogs's theorem it remains to prove the boundedness in some polydisc with center at  $a$  of a function that is holomorphic with respect to each variable. We note that the boundedness in some polydisc, not necessarily with center at  $a$ , follows solely from the continuity of  $f$  in the

<sup>(7)</sup>This means that for any  $a \in U$  and any  $\nu = 1, \dots, n$  the function  $f(a_1, \dots, a_{\nu-1}, z_\nu, a_{\nu+1}, \dots, a_n)$  of the variable  $z_\nu$  is holomorphic in the disc  $\{ |z_\nu| < r_\nu \} \subset \mathbb{C}$ .

separate variables. This fact forms the content of what is called OSGOOD'S LEMMA:

LEMMA 2. *We represent the polydisc  $U = \{z \in \mathbb{C}^n : \|z\| < R\}$  as a product of  $'U = \{z \in \mathbb{C}^{n-1} : \|z\| < R\}$  <sup>(8)</sup> by the disc  $U_n = \{z_n \in \mathbb{C} : |z_n| < R\}$ . If the function  $f(z, z_n)$  is continuous with respect to  $'z$  in  $'\bar{U}$  for any  $z_n \in \bar{U}_n$  and is continuous with respect to  $z_n$  in  $\bar{U}_n$  for any  $'z \in '\bar{U}$ , then there exists a polydisc  $W = 'W \times U_n \subset U$  in which  $f$  is bounded (see the Hartogs diagram in Figure 6).*

◀ For fixed  $'z \in '\bar{U}$  we write

$$M('z) = \max_{z_n \in \bar{U}_n} |f('z, z_n)|$$

and consider the sets  $E_m = \{z \in '\bar{U} : M('z) \leq m\}$ . These sets are closed, since if  $'z^{(\mu)} \in E_m$  ( $\mu = 1, 2, \dots$ ) and  $'z^{(\mu)} \rightarrow 'z$ , then  $'z \in E_m$  (in fact,  $|f('z^{(\mu)}, z_n)| \leq m$  for any  $z_n \in \bar{U}_n$ ; since  $f$  is continuous in  $'z$ , then  $|f('z, z_n)| \leq m$  for any  $z_n \in \bar{U}_n$ , i.e.,  $M('z) \leq m$ ). Obviously, the  $E_m$  form an increasing sequence and any point  $'z \in '\bar{U}$  belongs to all the  $E_m$  beginning with one of them.

There exists an  $E_M$  containing some domain  $'G \subset 'U$ . In fact, otherwise all the  $E_m$  would be nowhere dense; but then in  $'U$  there would exist a ball  $\bar{B}^1 \subset \mathbb{C}^{n-1}$  not containing any points of  $E_1$ , in  $B^1$  there would exist a ball  $\bar{B}^2$  not containing any points of  $E_2$ , and so on. We would have constructed a sequence of balls  $\bar{B}^k \subset \mathbb{C}^{n-1}$  which have a common point  $'z^0 \in '\bar{U}$ , and this point would not belong to any of the  $E_m$ .

Thus, there exists a domain  $'G$  in which  $|f('z, z_n)| \leq M$  for any  $z_n \in U_n$ . It remains to choose a polydisc  $'W = \{z : \|z - 'z^0\| < r\}$  in  $'G$ , and then we will have  $|f| \leq M$  in  $W = 'W \times U_n$ . ▶

In order to prove the boundedness of  $f$  in a polydisc with center  $a$  it will be necessary to use the holomorphy with respect to the individual variables. For this we need HARTOGS'S LEMMA, which is essentially based on properties of subharmonic functions. To state it we introduce the following notation:  $'V = U('a, R)$ ,  $'W = U('a, r)$  ( $r$  and  $R$  are scalars and  $r < R$ ),  $U_n = \{|z_n| < R\}$ ,  $V = 'V \times U_n$ , and  $W = 'W \times U_n$  (Figure 7).

LEMMA 3. *If the function  $f('z, z_n)$  is holomorphic with respect to  $'z$  in  $'\bar{V}$  for any  $z_n \in \bar{U}_n$  and holomorphic with respect to  $z$  in  $\bar{W}$ , then it is holomorphic in the entire polydisc  $\bar{V}$ .*

◀ Without loss of generality we may assume  $'a = '0$ . For any fixed  $z_n \in U_n$  and any  $'z \in 'V$  the function  $f$  is represented (since it is holomorphic

<sup>(8)</sup>Recall that  $'z = \{z_1, \dots, z_{n-1}\}$  denotes the projection into  $\mathbb{C}^{n-1}$  of the point  $z \in \mathbb{C}^n$ .

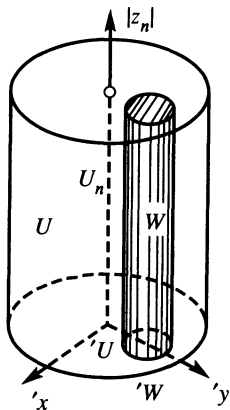

FIGURE 6

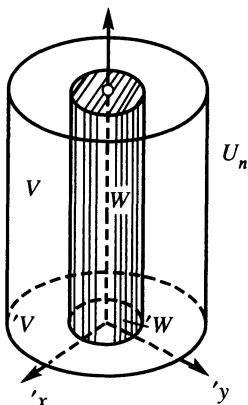

FIGURE 7

with respect to  $(z)$  by the convergent power series

$$f(z) = \sum_{|k|=0}^{\infty} c_k(z_n)(z)^k, \quad (3)$$

where  $k = (k_1, \dots, k_{n-1})$ . The coefficients of this series

$$c_k(z_n) = \frac{1}{k!} \frac{\partial^{|k|} f(0, z_n)}{(\partial' z)^k}$$

are holomorphic in the disc  $U_n$  as derivatives of a function that is holomorphic in  $z_n$  (the point  $(0, z_n) \in W$ ). Therefore the functions  $\frac{1}{|k|} \ln |c_k(z_n)|$  are subharmonic in  $U_n$ .

We choose an arbitrary number  $\rho < R$ ; since for any  $z_n \in U_n$

$$|c_k(z_n)| \rho^{|k|} \rightarrow 0$$

as  $|k| \rightarrow \infty$ , then for any  $z_n \in U_n$  there is a  $|k|$  beginning with which we will have  $\frac{1}{|k|} \ln |c_k(z_n)| + \ln \rho \leq 0$ , i.e.,

$$\overline{\lim}_{|k| \rightarrow \infty} \frac{1}{|k|} \ln |c_k(z_n)| \leq \ln \frac{1}{\rho}. \quad (4)$$

Now we use the holomorphy of  $f$  in  $\overline{W}$ ;  $f$  is bounded in  $\overline{W}$  (say  $|f| \leq M$ ), and the Cauchy inequalities  $|c_k(z_n)| r^{|k|} \leq M$  hold for any  $z_n \in U_n$ . Therefore for any  $z_n \in U_n$  and any  $|k|$

$$\frac{1}{|k|} \ln |c_k(z_n)| \leq \ln \frac{M^{1/|k|}}{r} \leq A. \quad (5)$$

Thus these subharmonic functions satisfy the hypotheses of the lim-sup theorem (subsection 3 of the Appendix to Part I). By this theorem for any  $\sigma < \rho$  one can find a number  $k_0$  such that for all  $|k| > k_0$  and all  $z_n$ ,  $|z_n| \leq \sigma$ , we have  $\frac{1}{|k|} \ln |c_k(z_n)| \leq \ln \frac{1}{\sigma}$ , i.e.,

$$|c_k(z_n)| \sigma^{|k|} \leq 1.$$



From this it follows that the series (3) converges uniformly in any polydisc  $\overline{U}(0, \sigma')$ ,  $\sigma' < \sigma$ ; but the terms of this series are continuous in  $z$ , so that the sum  $f$  of the series is also continuous, and hence is bounded in  $U(0, \sigma')$ . This polydisc can be assumed to be arbitrarily close to  $V$ , and since  $V$  from the very beginning could be increased a little,<sup>(9)</sup> then  $f$  is bounded, and hence, by Lemma 1 and the remark after Theorem 3 it is holomorphic in  $\overline{V}$ . ►

Now we are ready for the proof of the fundamental theorem.

**HARTOGS'S THEOREM.** *If the function  $f$  is holomorphic at any point of the domain  $D \subset \mathbb{C}^n$  with respect to each of the variables  $z_\nu$ , then it is holomorphic in  $D$ .*

◀ It suffices to prove the holomorphy of  $f$  at an arbitrary point  $z^0 \in D$ , and without loss of generality we may assume that  $z^0 = 0$ . Thus, suppose  $f$  is holomorphic with respect to each variable in the polydisc  $\overline{U}(0, R)$ ; we must prove that it is holomorphic in some polydisc with center at 0.

We shall prove this assertion by induction on the number of complex variables. For one variable it is trivial; assume that it is true for functions of  $(n - 1)$  variables, and we let  $'U = U('0, R/3)$ . From the assumption it follows that the function  $f('z, z_n)$  is continuous with respect to  $'z$  in  $'\overline{U}$  for any  $z_n \in \overline{U}_n = \{|z_n| \leq R\}$  and with respect to  $z_n$  in  $\overline{U}_n$  for any  $'z \in '\overline{U}$ . By Osgood's lemma  $f$  is bounded, and hence, it is also holomorphic in some polydisc  $\overline{W} = '\overline{W} \times \overline{U}_n$ , where  $'\overline{W} = U('a, r) \subset 'U$  (Figure 8).

Now we consider the polydisc  $V = 'V \times U_n$ , where  $'V = U('a, \frac{2}{3}R)$ . Obviously,  $\overline{V} \subset \overline{U}(0, R)$ , and hence  $f$  is holomorphic with respect to  $'z$  in  $'\overline{V}$  for any  $z_n \in \overline{U}_n$ , and by what we just proved it is holomorphic with respect to  $z$  in  $\overline{W}$ . By Hartogs's lemma it follows from this that it is also holomorphic with respect to  $z$  in  $V$ , which already contains the point  $z = 0$ . Thus the assertion is proved also for functions of  $n$  variables. ►

We give yet another formulation of Hartogs's theorem.

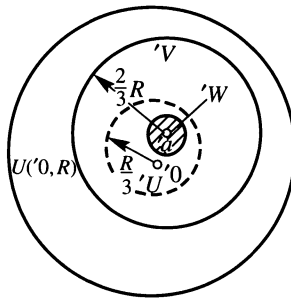

FIGURE 8

<sup>(9)</sup>The hypotheses of the lemma require holomorphy in CLOSED polydiscs.

We shall say that a function  $f$  is holomorphic at a point  $a \in \mathbb{C}^n$  in the sense of RIEMANN if

(R)  $f$  is holomorphic with respect to each variable  $z_\nu$  in some polydisc  $U(a, r)$ .

We shall say that a function  $f$  is holomorphic at the point  $a$  in the sense of WEIERSTRASS if

(W)  $f$  can be expanded in some polydisc  $U(a, r)$  in a power series

$$f(z) = \sum_{|k|=0}^{\infty} c_k (z-a)^k.$$

The implication (W)  $\Rightarrow$  (R) is obvious and the implication (R)  $\Rightarrow$  (W) is the content of the fundamental theorem of Hartogs. Consequently this theorem can be formulated as:

*The concepts of holomorphy in the sense of Riemann and holomorphy in the sense of Weierstrass are equivalent.*

### §3. Series expansions

Here we consider basic questions related to series expansions of holomorphic functions.

**7. Power series.** In subsection 5 we proved that any function that is holomorphic in the polydisc  $U(a, r)$  can be expanded in this disc in a multiple power series with center at  $a$ . The question arises concerning the set of points of convergence of this series. By analogy with functions of one variable one wants to expect that this set will be the polydisc, completed by some set of boundary points. However, very simple examples show that the situation is quite different.

EXAMPLES.

1. The set of convergence of the power series

$$\frac{1}{1 - z_1 z_2} = \sum_{\mu=0}^{\infty} z_1^\mu z_2^\mu \quad (1)$$

( $\mu$  is a scalar index) in  $\mathbb{C}^2$  is the complete Reinhardt domain  $\{|z_1 z_2| < 1\}$ .

2. The set of convergence in  $\mathbb{C}^2$  for the series

$$\frac{z_1}{(1 - z_1)(1 - z_2)} = \sum_{|k|=0}^{\infty} z_1^{k_1+1} z_2^{k_2} \quad (2)$$

is the bidisc  $\{|z_1| < 1, |z_2| < 1\}$ , completed by the complex line  $\{z_1 = 0\}$ .

The question is simplified if instead of the set of convergence we consider its INTERIOR.

DEFINITION. The *domain of convergence* of the power series

$$\sum_{|k|=0}^{\infty} c_k (z-a)^k \quad (3)$$

is the interior  $\overset{\circ}{S}$  of the set  $S$  of points  $z \in \mathbb{C}^n$  at which this series converges for some ordering of its terms.

From Abel's lemma (subsection 5) we can derive

**THEOREM 1.** *If the point  $z^0$  belongs to the domain of convergence  $S$  of the series (3), then the closed polydisc  $\bar{U} = \{z \in \mathbb{C}^n : |z_\nu - a_\nu| \leq |z_\nu^0 - a_\nu|\}$  also belongs to  $\mathring{S}$  and the series (3) converges absolutely and uniformly in  $\bar{U}$ .<sup>(10)</sup>*

◀ Since  $z^0 \in \mathring{S}$  and  $\mathring{S}$  is open, there exists a point  $\zeta \in \mathring{S}$  such that  $|\zeta_\nu - a_\nu| > |z_\nu^0 - a_\nu|$ ,  $\nu = 1, \dots, n$ , and the series (3) converges at this point. Since  $U \subset \subset \{z \in \mathbb{C}^n : |z_\nu - a_\nu| < |\zeta_\nu - a_\nu|\}$ , then by Abel's lemma the series (3) converges absolutely and uniformly in  $\bar{U}$ . ▶

Theorem 1 can also be formulated as follows: *the domain of convergence  $\mathring{S}$  of the series (3) is a complete Reinhardt domain with center at  $a$* . Thus, complete Reinhardt domains play the same role in the case of functions of several variables as discs do in the case of one variable. This analogy is stressed by the following theorem.

**THEOREM 2.** *Any function  $f$  that is holomorphic in a complete Reinhardt domain  $D \subset \mathbb{C}^n$  with center at  $a$  is represented in this domain by the Taylor expansion*

$$f(z) = \sum_{|k|=0}^{\infty} c_k (z - a)^k. \quad (4)$$

◀ Let  $z^0$  be an arbitrary point of  $D$ . Then the polydisc  $\bar{U} = \{|z_\nu - a_\nu| \leq |z_\nu^0 - a_\nu|\} \subset \subset D$  and by Theorem 2 of subsection 5 the function  $f$  is represented in  $U$  by a Taylor expansion centered at  $a$ . The coefficients of this expansion are computed via the derivatives of  $f$  at  $a$ , and hence, coincide with  $c_k$ , i.e., this expansion is the same as (4). ▶

A natural question arises: Is every complete Reinhardt domain the domain of convergence of some power series? The answer to this is "No", since, as we shall now prove, domains of convergence possess some additional properties.

**DEFINITION.** We denote by

$$z \rightarrow \lambda(z) = (\ln|z_1|, \dots, \ln|z_n|) \quad (5)$$

a mapping of the set  $\{z \in \mathbb{C}^n : z_1 \cdots z_n \neq 0\}$  into the space  $\mathbb{R}^n$ . The *logarithmic image* of a set  $M \subset \mathbb{C}^n$  is the set  $M^* = \lambda(M_0)$ , where  $M_0 = \{z \in M : z_1 \cdots z_n \neq 0\}$ . The set  $M$  is said to be *logarithmically convex* if its logarithmic image  $M^*$  is a convex set in  $\mathbb{R}^n$ .

**EXAMPLE.** The set  $M \subset \mathbb{C}^2$ , whose Reinhardt diagram  $\alpha(M)$  is shown in Figure 9(a), is not logarithmically convex; its logarithmic image  $\lambda(M)$ <sup>(11)</sup> is given in Figure 9(b). The loga-

<sup>(10)</sup>From Theorem 1 it follows that the set  $\mathring{S}$  is connected: any two points  $z'$  and  $z''$  of it can be joined from the center (and hence to each other) by a polygonal line belonging to  $\mathring{S}$ . Since  $\mathring{S}$  is also open, then it is in fact a domain.

<sup>(11)</sup>For simplicity we write  $\lambda(M)$  instead of  $\lambda(M_0)$ .

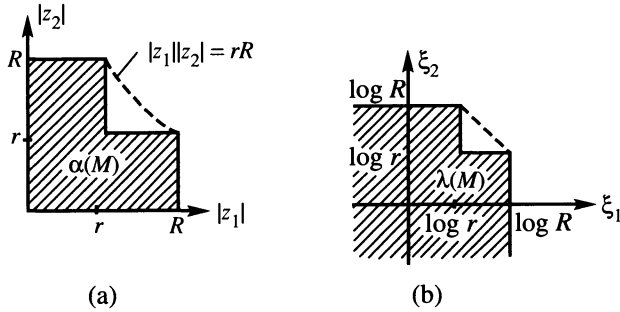

FIGURE 9

rithmically convex hull of  $M$  (i.e., the intersection of all the logarithmically convex sets that contain  $M$ ) is obtained if we consider the inverse image of the convex hull of the set  $\lambda(M)$ . The Reinhardt diagram of this hull  $\widehat{M}_L$  is different from  $\alpha(M)$  by a segment bounded by a segment of the hyperbola  $|z_1||z_2| = rR$  (shown by the dashed line in Figure 9).

**THEOREM 3.** *The domain of convergence  $\overset{\circ}{S}$  of the power series (3) is logarithmically convex.*

◀ Without loss of generality we assume that  $a = 0$ . We must prove that  $S^* = \lambda(\overset{\circ}{S})$  is a convex set. Suppose that  $\ln|z'|, \ln|z''| \in S^*$  and that  $z \in \mathbb{C}^n$  is such that  $\ln|z| = t \ln|z'| + (1-t) \ln|z''|$ ,  $0 < t < 1$ , i.e.,  $|z| = |z'|^t |z''|^{1-t}$ . Since  $z', z'' \in \overset{\circ}{S}$ , the series (3) converges at these points and hence its terms are bounded: suppose  $|c_k(z')^k| \leq M_1$  and  $|c_k(z'')^k| \leq M_2$ . But then  $|c_k z^k| = |c_k(z')^k|^t |c_k(z'')^k|^{1-t} \leq M_1^t M_2^{1-t}$ , i.e., the terms of (3) are bounded at  $z$ . Since  $\overset{\circ}{S}$  is open, the same argument holds for points close to  $z'$  and  $z''$ , and hence the terms of (3) are bounded at all points close to  $z$ . By Abel's lemma it follows from this that  $z \in \overset{\circ}{S}$ . ▶

Later on we shall prove that this additional condition indeed characterizes domains of convergence: any logarithmically convex complete Reinhardt domain is the domain of convergence of some power series (see subsection 40 below).

Now we note an important fact. We consider a complete, but not logarithmically convex, Reinhardt domain (say from the example given above). By Theorem 2 any function  $f \in \mathcal{O}(D)$  can be represented in  $D$  by a power series. But by Theorem 3 the domain of convergence of this series is logarithmically convex, and hence it converges at least in the logarithmically convex hull  $\widehat{D}_L$  of the domain  $D$ . The sum of this series realizes an *analytic continuation* of  $f$  from  $D$  into  $\widehat{D}_L$ . We observe an effect that is a principal distinction of the higher-dimensional case from the plane: while in  $\mathbb{C}^1$  any domain is the domain of holomorphy of some function (see subsection 46 of Part I), in  $\mathbb{C}^n$  ( $n > 1$ ) there exist domains from which every holomorphic function is necessarily analytically continued into a larger domain.

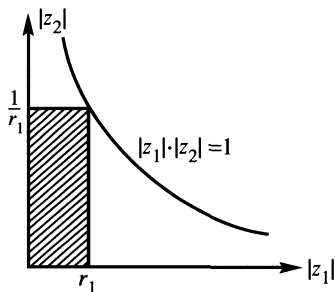

FIGURE 10

This effect of a necessary analytic continuation will be considered in more detail in Chapter III.

We now give a more constructive method of describing the domain of convergence  $\bar{S}$  of a given power series (3). This domain is exhausted by polydiscs, which are called polydiscs of convergence. For example, for the series (1), whose domain of convergence is  $\mathring{S} = \{z \in \mathbb{C}^2 : |z_1 z_2| < 1\}$ , such polydiscs are  $\{|z_1| < r_1, |z_2| < 1/r_1\}$ ,  $0 < r_1 < \infty$  (Figure 10).

Here is a more precise definition.

**DEFINITION.** A polydisc  $U(a, r)$  is called a *polydisc of convergence* of the series (3) if  $U \subset \bar{S}$ , but in any polydisc  $\{z \in \mathbb{C}^n : |z_\nu - a_\nu| < r'_\nu\}$ , where  $r'_\nu \geq r_\nu$  ( $\nu = 1, \dots, n$ ) and at least one of these inequalities is strict, there are points at which (3) diverges. The radii  $r_\nu$  of this disc are called *conjugate radii of convergence*.

**THEOREM 4.** *The conjugate radii of convergence of the series (3) satisfy the relation*

$$\overline{\lim}_{|k| \rightarrow \infty} \sqrt[|k|]{|c_k| r^k} = 1 \quad (6)$$

(the higher-dimensional analogue of the CAUCHY-HADAMARD formula).

◀ We set  $z = a + \zeta r$ ,  $\zeta \in \mathbb{C}$  (i.e.,  $z_\nu = a_\nu + \zeta r_\nu$ ); for  $|\zeta| < 1$  the point  $z$  belongs to the polydisc of convergence  $U$ , the series (3) converges absolutely in  $U$ , and after regrouping the terms

$$\sum_{|k|=0}^{\infty} |c_k| (z - a)^k = \sum_{|k|=0}^{\infty} |c_k| r^k \zeta^{|k|} = \sum_{\mu=0}^{\infty} \left( \sum_{|k|=\mu} |c_k| r^k \right) \zeta^\mu,$$

we obtain a series in powers of  $\zeta$  which converges for  $|\zeta| < 1$ . For  $|\zeta| > 1$  this series diverges, since otherwise by Abel's lemma from subsection 5 the series would converge in some polydisc containing  $U$ . Therefore by the

Cauchy-Hadamard formula for series of one variable

$$\overline{\lim}_{\mu \rightarrow \infty} \sqrt[\mu]{\sum_{|k|=\mu} |c_k| r^k} = 1. \quad (7)$$

In the group of terms of (3) with given  $|k| = \mu$  we choose a maximal term  $|c_m| r^m = \max_{|k|=\mu} |c_k| r^k$ . Using the obvious estimate

$$|c_m| r^m \leq \sum_{|k|=\mu} |c_k| r^k \leq (\mu + 1)^n |c_m| r^m$$

and the fact that  $(\mu + 1)^{n/\mu} \rightarrow 1$  as  $\mu \rightarrow \infty$ , we can rewrite (7) as the relation

$$\overline{\lim}_{\mu \rightarrow \infty} \sqrt[\mu]{|c_m| r^m} = 1,$$

equivalent to (6). ►

Relation (6), which can be written as an equation

$$\varphi(r_1, \dots, r_n) = 0 \quad (8)$$

connecting the conjugate radii of convergence of series (3), determines the boundary of the domain  $\alpha(\overset{\circ}{S})$ , which shows the domain of convergence  $\overset{\circ}{S}$  on the Reinhardt diagram. Substituting  $r_\nu = e^{\xi_\nu}$  in (8), we obtain the equation

$$\Psi(\xi_1, \dots, \xi_n) = 0 \quad (9)$$

for the boundary of  $\lambda(\overset{\circ}{S})$ , the logarithmic image of  $\overset{\circ}{S}$ , some convex domain in  $\mathbb{R}^n$ .

**8. Other series.** Besides power series, in the theory of functions of several complex variables we also consider series of other types. The most important of these are the so-called Hartogs series. We consider the power series

$$\sum_{|k|=0}^{\infty} c_k (z - a)^k \quad (1)$$

and at an arbitrary point  $z$  of its domain of convergence  $\overset{\circ}{S}$  we regroup the terms of this series, arranging them in powers of one of the differences  $z_\nu - a_\nu$ , say the  $n$ th one (this is legal because of the absolute convergence). We obtain a series

$$\sum_{\mu=0}^{\infty} g_\mu(z) (z_n - a_n)^\mu \quad (2)$$

( $\mu$  is a scalar index), whose coefficients  $g_\mu$  are holomorphic in  $\overset{\circ}{S}$ , the projection of  $\overset{\circ}{S}$  into the space  $\mathbb{C}^{n-1}$ .

We notice that such a regrouping of the terms of a series can lead to an extension of the domain of convergence. For example, the power series

$$\frac{1}{(1 - z_1)(1 - z_2)} = \sum_{|k|=0}^{\infty} z_1^{k_1} z_2^{k_2}$$

converges in the bidisc  $\{|z_1| < 1, |z_2| < 1\}$ . After regrouping the terms we obtain the series

$$\sum_{\mu=0}^{\infty} \left( \sum_{k_1=0}^{\infty} z_1^{k_1} \right) z_2^{\mu} = \sum_{\mu=0}^{\infty} \frac{z_2^{\mu}}{1-z_1},$$

which converges in the domain  $\{z_1 \neq 1, |z_2| < 1\}$ .

**DEFINITION.** A series of the form (2), whose coefficients  $g_{\mu}$  are holomorphic functions of  $'z = (z_1, \dots, z_{n-1})$ , is called a *Hartogs series* with plane of centers  $\{z_n = a_n\}$ . The *domain of convergence* of this series is the interior  $\overset{\circ}{H}$  of the set of points  $(z, z_n)$  such that the series (2) with coefficients  $g_{\mu}(z)$  converges at the point  $z_n$  and the coefficients are holomorphic at  $'z$ .

Since along with each  $z^0$  the domain of convergence  $\overset{\circ}{H}$  of a Hartogs series also contains all the points  $z = (z^0, z_n)$ , where  $|z_n - a_n| \leq |z_n^0 - a_n|$ , then  $\overset{\circ}{H}$  is always a complete Hartogs domain with plane of symmetry  $\{z_n = a_n\}$ , i.e., a domain of the form  $\{(z, z_n): z \in 'D, |z_n - a_n| < R(z)\}$ ; the function  $R(z)$  is called the *Hartogs radius*.<sup>(12)</sup>

Domains of this type play the same role for Hartogs series as Reinhardt domains do for power series. In particular, we have

**THEOREM 1.** Any function  $f$  that is holomorphic in a complete Hartogs domain  $D$  with plane of symmetry  $\{z_n = a_n\}$  is represented in  $D$  by an expansion

$$f(z) = \sum_{\mu=0}^{\infty} g_{\mu}(z)(z_n - a_n)^{\mu} \quad (3)$$

with coefficients that are holomorphic in the projection  $'D$  of  $D$  into  $\mathbb{C}^{n-1}$ .

◀ Along with each point  $z^0 \in D$  the domain  $D$  also contains the polydisc  $U = 'U \times U_n$ , where  $'U \subset \mathbb{C}^{n-1}$  is a sufficiently small polydisc with center at the projection  $'z^0$  of the point  $z^0$ , and  $U_n \subset \mathbb{C}$  is a disc with center  $a_n$  containing the point  $z_n^0$ . In  $U$  the function  $f$  is holomorphic with respect to  $z_n$  for any  $'z \in 'U$ , and hence, can be expanded in a series (3) with coefficients

$$g_{\mu}(z) = \frac{1}{\mu!} \frac{\partial^{\mu} f(z, a_n)}{\partial z_n^{\mu}}.$$

---

<sup>(12)</sup>The Hartogs radius  $R(z)$  may not coincide with the radius of convergence  $r(z)$  of the series (2), considered as a power series in  $z_n - a_n$ , since we have passed from the set of convergence  $H$  to its interior  $\overset{\circ}{H}$ . The function  $r(z)$  is determined from the Cauchy-Hadamard formula

$$1/r(z) = \overline{\lim}_{\mu \rightarrow \infty} \sqrt[\mu]{|g_{\mu}(z)|};$$

it may not be lower semicontinuous, and then the set  $\{z \in 'D: |z_n - a_n| < r(z)\}$  will not be open. It is not difficult to see that  $R$  is a lower semicontinuous regularization of  $r$ :

$$R(z) = \lim_{\zeta \rightarrow z} r(\zeta).$$

These coefficients, however, are defined and holomorphic not only in  $'U$ , but also in the whole projection  $'D$  of the domain  $D$ , so that the expansion (3) is also realized in the entire domain  $D$ . ►

Further, not every complete Hartogs domain is the domain of convergence of some Hartogs series: in subsection 40 we shall show that domains of convergence are characterized by an additional property that the radius  $R('z)$  must possess.

We now briefly describe the higher-dimensional analogues of LAURENT SERIES.

**THEOREM 2.** *Every function  $f$ , holomorphic in a product of circular annuli  $\Pi = \{z \in \mathbb{C}^n : r_\nu < |z_\nu - a_\nu| < R_\nu\}$  can be represented in  $\Pi$  as a multiple Laurent series*

$$f(z) = \sum_{|k|=-\infty}^{\infty} c_k (z-a)^k, \quad (4)$$

in which the summation is taken over all integer vectors  $k = (k_1, \dots, k_n)$ , and the coefficients

$$c_k = \frac{1}{(2\pi i)^n} \int_{\Gamma} \frac{f(\zeta) d\zeta}{(\zeta - a)^{k+1}}, \quad (5)$$

where  $\Gamma$  is the product of the circles  $\gamma_\nu$ :  $\zeta_\nu = a_\nu + \rho_\nu e^{it}$  ( $\nu = 1, \dots, n$ ;  $r_\nu < \rho_\nu < R_\nu$ ;  $0 \leq t \leq 2\pi$ ).

◀ The expansion (4) is obtained in the usual way: we choose  $\rho_\nu^\pm$  so that  $(\rho_\nu^-, \rho_\nu^+) \subset (r_\nu, R_\nu)$  and in the product of annuli  $\{\rho_\nu^- \leq |z_\nu - a_\nu| \leq \rho_\nu^+\}$  the function  $f$  is representable by Cauchy's integral formula as

$$f(z) = \frac{1}{(2\pi i)^n} \sum_{\varepsilon} \int_{\Gamma^\varepsilon} \frac{f(\zeta) d\zeta}{\zeta - z}. \quad (6)$$

Here  $\varepsilon = (\varepsilon_1, \dots, \varepsilon_n)$  is a set consisting of  $+$ 's and  $-$ 's, and  $\Gamma^\varepsilon = \gamma_1^{\varepsilon_1} \times \dots \times \gamma_n^{\varepsilon_n}$ , where  $\gamma_\nu^{\varepsilon_\nu} = \{|\zeta_\nu - a_\nu| = \rho_\nu^{\varepsilon_\nu}\}$  is a circle with positive orientation if  $\varepsilon_\nu = +$  and with negative orientation if  $\varepsilon_\nu = -$ . The sum is taken over all sets  $\varepsilon$  of  $n$  signs. Further, we expand  $1/(\zeta - z)$  in the corresponding geometric progressions, integrate termwise, and replace the integrals over  $\gamma_\nu^{\varepsilon_\nu}$  by integrals over  $\gamma_\nu$  (with a change of sign if  $\varepsilon_\nu = -$ ). ►

The domains of convergence of Laurent series (4) are obviously Reinhardt domains. Moreover, if the domain of convergence contains some point  $z^0$  with coordinate  $z_\nu^0 = a_\nu$ , then the expansion (4) cannot contain negative powers of the difference  $z_\nu - a_\nu$ , i.e., relative to this difference (4) is a Taylor expansion. Therefore the domain of convergence of Laurent series are so-called *relatively complete* Reinhardt domains. A Reinhardt domain is said to be relatively complete if for fixed  $\nu$  it either does not intersect the plane  $\{z_\nu = a_\nu\}$ , or, along with each  $z^0$ , it also contains all points  $z$  for which  $|z_\nu - a_\nu| \leq |z_\nu^0 - a_\nu|$ , and the remaining coordinates are the same as  $z^0$  (this condition holds for all  $\nu$ ).



Thus, if a Reinhardt domain does not intersect one of the planes  $\{z_\nu = a_\nu\}$ , then the condition of relative completeness does not impose any restrictions, but the intersection with each such plane implies an additional condition.

Just as in the case of Taylor series, one proves that the domains of convergence of Laurent series are still logarithmically convex. Every function  $f$  that is holomorphic in a relatively complete Reinhardt domain  $D$  is represented in  $D$  by a Laurent series (4) (and this representation realizes an analytic continuation of  $f$  into the logarithmically convex hull of  $D$  if  $D$  is not logarithmically convex).

We can also consider another analogue of Laurent series. Namely, every function  $f$  that is holomorphic in a Hartogs domain of the form  $\{z \in \mathbb{C}^n: z \in {}'D, r(z) < |z_n - a_n| < R(z)\}$ , where  $'D$  is a domain in  $\mathbb{C}^{n-1}$ , can be represented in this domain by a *Hartogs-Laurent series*

$$f(z) = \sum_{\mu=-\infty}^{\infty} g_\mu({}'z)(z_n - a_n)^\mu, \quad (7)$$

where  $g_\mu \in \mathcal{O}({}'D)$ . The domains of convergence of such series are characterized by additional properties of the radii  $r({}'z)$  and  $R({}'z)$ , which we shall discuss in subsection 40.

To conclude we discuss SERIES IN HOMOGENEOUS POLYNOMIALS. A polynomial  $p_\nu(z)$  is said to be *homogeneous* of degree  $\nu$  if  $p_\nu(\lambda z) = \lambda^\nu p_\nu(z)$  for all  $\lambda \in \mathbb{C}$  and  $z \in \mathbb{C}^n$ . Series in such polynomials are obtained from power series by regrouping the terms:

$$\sum_{|k|=0}^{\infty} c_k z^k = \sum_{\nu=0}^{\infty} \left( \sum_{|k|=\nu} c_k z^k \right) = \sum_{\nu=0}^{\infty} p_\nu(z) \quad (8)$$

( $\nu$  is a scalar index). As in the case of Hartogs series, this regrouping may lead to an extension of the domain of convergence; we see now that series in homogeneous polynomials converge in a wider class of domains than power series:

**THEOREM 3.** *Any function  $f$  that is holomorphic in a complete circular domain  $D$  with center  $z = 0$  can be expanded in this domain in a series in homogeneous polynomials*

$$f(z) = \sum_{\nu=0}^{\infty} p_\nu(z), \quad (9)$$

where  $p_\nu$  is formed from the terms  $c_k z^k$  of the Taylor expansion of  $f$  at 0 for which  $|k| = \nu$ , and the series converges uniformly on compact subsets of  $D$ .

◀ Suppose  $z \in D \setminus \{0\}$  and  $\omega = z/|z|$ . The complex line  $\zeta = \lambda\omega$ ,  $\lambda \in \mathbb{C}$ , passes through  $z$  and intersects  $D$  in the disc  $\{\lambda : |\lambda| < R(\omega)\}$ .

Since  $0 \in D$ , the series

$$f(\zeta) = \sum_{|k|=0}^{\infty} c_k \zeta^k = \sum_{\nu=0}^{\infty} p_{\nu}(\zeta)$$

converges in some neighborhood of the origin and restriction to the complex line  $\{\zeta = \lambda\omega\}$  gives

$$\varphi(\lambda) = f(\lambda\omega) = \sum_{\nu=0}^{\infty} p_{\nu}(\lambda\omega) = \sum_{\nu=0}^{\infty} p_{\nu}(\omega)\lambda^{\nu}. \quad (10)$$

Since  $f \in \mathcal{O}(D)$ ,  $\varphi$  is holomorphic in the disc  $\{|\lambda| < R(\omega)\}$  and (10) is its Taylor expansion; it converges in this disc, and since we assumed  $|z| < R(\omega)$  and  $z = |\omega|z$ , then the series (9) converges at the point  $z$ .

Now if  $K \subset\subset D$ , then there exist functions  $r(\omega)$ ,  $0 < r(\omega) < R(\omega)$ , and a number  $q$ ,  $0 < q < 1$ , such that for all  $z \in K$  we have  $|z| \leq qr(\omega)$ , where  $\omega = z/|z|$ . Therefore for all  $z \in K$

$$|p_{\nu}(z)| = |p_{\nu}(\omega)||z|^{\nu} \leq |p_{\nu}(\omega)|r^{\nu}(\omega)q^{\nu}. \quad (11)$$

But by the integral formula for the Taylor coefficients

$$p_{\nu}(\omega) = \frac{1}{2\pi i} \int_{|\lambda|=r(\omega)} \frac{f(\lambda\omega)}{\lambda^{\nu+1}} d\lambda,$$

from which, using the fact that the set  $\{\lambda\omega : |\lambda| = r(\omega)\} \subset\subset D$  and hence  $|f(\lambda\omega)| \leq M$  there, we find that  $|p_{\nu}(\omega)| \leq M/r^{\nu}(\omega)$  (Cauchy's inequalities for the Taylor coefficients). Substituting this in (11), we obtain that  $|p_{\nu}(z)| \leq Mq^{\nu}$  for all  $z \in K$ . Since  $0 < q < 1$ , this proves the uniform convergence of (9) on  $K$ . ►

We remark that not every complete circular domain is the domain of convergence of some series in homogeneous polynomials; the situation here is just as in the case of Hartogs series. This is seen from the fact that the transformation  $(z, z_n) \rightarrow (w, z_n)$ , where  $w_{\nu} = z_{\nu}/z_n$  ( $\nu = 1, \dots, n-1$ ), taking a circular domain into a Hartogs domain, transforms the expansion (9) into

$$g(w, z_n) = f(wz_n, z_n) = \sum_{\nu=0}^{\infty} p_{\nu}(w, 1)z_n^{\nu},$$

i.e., the Hartogs expansion for the image of the function  $f$ .

To conclude we give a radial analogue of the fundamental theorem of Hartogs, proved recently, in 1978, by F. FORELLI.

**THEOREM 4.** *If  $f$  is a function defined in the unit ball  $B \subset \mathbb{C}^n$ , holomorphic on the intersection of  $B$  with every complex line  $l$  passing through the point  $z = 0$ , and if  $f$  is of class  $C^{\infty}$  in a neighborhood of this point, then it is holomorphic in  $B$ .*

◀ Let  $z \in B \setminus \{0\}$  be an arbitrary point; from the condition that  $f$  is holomorphic on the complex line passing through  $z = 0$  and this point, it

follows that

$$f(\lambda z) = f(0) + \sum_{k=1}^{\infty} F_k(z) \lambda^k, \quad (12)$$

and the series converges absolutely and uniformly in the closed disc  $\{|\lambda| \leq 1\}$ . From this it follows that the series of the  $|F_k(z)|$  converges, and hence for  $|z| < 1$  the function

$$F(z) = \sum_{k=1}^{\infty} F_k(z)$$

is defined.

Further, from (12) for any  $\lambda$  and  $\mu$  from the unit disc  $U \subset \mathbb{C}$  we will obtain two expansions

$$f(\lambda \mu z) = f(0) + \sum_{k=1}^{\infty} F_k(\lambda z) \mu^k = f(0) + \sum_{k=1}^{\infty} F_k(z) \lambda^k \mu^k,$$

from which by the uniqueness theorem for power series expansion we get the identities

$$F_k(\lambda z) = \lambda^k F_k(z), \quad k = 1, 2, \dots \quad (13)$$

By Cauchy's theorem for the coefficients of (12)

$$F_k(z) = \frac{1}{2\pi i} \int_{\{|\lambda|=1\}} \frac{f(\lambda z)}{\lambda^{k+1}} d\lambda,$$

and since by hypothesis the function  $f$  is of class  $C^\infty$  in some ball  $B_r = \{|z| < r\}$ , then it follows from this formula that  $F_k \in C^\infty(B_r)$ . In particular, they are bounded in  $B_r$  and then from (13) it follows that  $F_k(z) = O(|z|^k)$  as  $z \rightarrow 0$ .

By Taylor's formula for smooth functions we will obtain from this that for  $z \in B_r$ ,

$$F_k(z) = \sum_{\mu+\nu=k} P_{\mu\nu}(z) + |z|^k \gamma(z), \quad (14)$$

where  $P_{\mu\nu}$  is a polynomial in  $z$  and  $\bar{z}$  of general degree  $\mu$  in  $z$  and  $\nu$  in  $\bar{z}$ , and  $\gamma(z) \rightarrow 0$  as  $z \rightarrow 0$  (the lower-order terms vanish because  $F_k(z) = O(|z|^k)$ ). Substituting this in (13), we will obtain the identity

$$\sum_{\mu+\nu=k} P_{\mu\nu}(z) \lambda^\mu \bar{\lambda}^\nu + |\lambda|^k |z|^k \gamma(\lambda z) = \sum_{\mu+\nu=k} P_{\mu\nu}(z) \lambda^k + \lambda^k |z|^k \gamma(z), \quad (15)$$

valid for all  $z \in B_r$  and  $|\lambda| \leq 1$ . In particular, for positive  $\lambda < 1$  it follows from this that  $\gamma(\lambda z) = \gamma(z)$ , and hence as  $\lambda \rightarrow 0$  we find that  $\gamma(z) \equiv 0$  in  $B_r$ . But then from (15), again by the theorem on the uniqueness of power series expansions, we see that  $P_{\mu\nu} \equiv 0$  for  $\nu > 0$ , and then it follows from (14) that  $F_k(z) = P_{k0}(z)$  are polynomials in  $z$ , i.e., are holomorphic functions, and not only in  $B_r$ , but everywhere in  $\mathbb{C}^n$ .

The series of the  $F_k$  by Theorem 3 converges uniformly on compact subsets of  $B$ , and from the theorem of Weierstrass we conclude that  $F \in \mathcal{O}(B)$ . But from (12) for  $\lambda = 1$  it follows that  $f(z) = f(0) + F(z)$ , and hence,  $f \in \mathcal{O}(B)$ . ▶

We note that the condition in this theorem that  $f$  be  $C^\infty$  in a neighborhood of the origin is essential: the function  $z_1^{k+2}\bar{z}_2/|z|^2$  in  $\mathbb{C}^2$  is of class  $C^k$  and holomorphic on every complex line passing through the origin, but is not holomorphic.

\* How is Forelli's theorem changed if in addition to  $f$  being  $C^\infty$  in a neighborhood of the origin we require that it be holomorphic only on the intersection of  $B$  with complex lines from some cone with vertex at the origin? Or with a finite set of complex lines (passing through the origin)? \*

#### §4. Holomorphic mappings

**9. Properties of holomorphic mappings.** Let  $D$  be a domain in  $\mathbb{C}^n$  and let  $f = (f_1, \dots, f_m): D \rightarrow \mathbb{C}^m$ ; this mapping is said to be *holomorphic* if all its components  $f_\mu$  ( $\mu = 1, \dots, m$ ) are holomorphic in  $D$ . In particular, if  $D \subset \mathbb{C}$ , then  $f$  is called a *holomorphic curve*.

If  $U$  is a neighborhood of a point  $z \in \mathbb{C}^n$  and  $f: U \rightarrow \mathbb{C}^m$  is a holomorphic mapping, then for a vector  $h \in \mathbb{C}^n$  with  $|h|$  sufficiently small we have the expansion

$$f(z+h) = f(z) + df(h) + o(h); \quad (1)$$

the  $\mathbb{C}$ -linear mapping

$$df(h) = f'(z)h, \quad (2)$$

where  $f'(z) = (\partial f_\mu / \partial z_\nu)$  is the Jacobian matrix and  $h$  is a column vector, is called the *differential of the mapping  $f$*  at the point  $z$ . The point  $z$  is said to be *noncritical* if the rank of  $f'(z)$  is maximal, i.e., is equal to  $\min(m, n)$ . In particular, for  $m = n$  we can consider the determinant

$$\det f'(z) = J_f(z), \quad (3)$$

which is called the *Jacobian* of  $f$  at  $z$ ; at noncritical points  $J_f(z) \neq 0$ , and only at such points.

We shall use the exterior multiplication of differentials  $dz_\mu \wedge dz_\nu$ , which possesses the properties of anticommutativity ( $dz_\nu \wedge dz_\mu = -dz_\mu \wedge dz_\nu$ , and in particular,  $dz_\nu \wedge dz_\nu = 0$ ), associativity, and distributivity, and also allows us to remove the scalar (complex) factors in the product sign.<sup>(13)</sup> From these properties it follows that for a holomorphic mapping  $f: U \rightarrow \mathbb{C}^n$ , where

<sup>(13)</sup>We assume that the reader is familiar with the sign from an exterior product; see, for example, W. Rudin, *Principles of mathematical analysis*, McGraw-Hill, New York, 1964, p. 211; see also subsection 13 below.

$U \subset \mathbb{C}^n$ , we have

$$\begin{aligned} df_1 \wedge \cdots \wedge df_n &= \left( \frac{\partial f_1}{\partial z_1} dz_1 + \cdots + \frac{\partial f_1}{\partial z_n} dz_n \right) \\ &\quad \wedge \cdots \wedge \left( \frac{\partial f_n}{\partial z_1} dz_1 + \cdots + \frac{\partial f_n}{\partial z_n} dz_n \right) \\ &= J_f(z) dz_1 \wedge \cdots \wedge dz_n \end{aligned} \quad (4)$$

and analogously for the complex conjugate mapping

$$d\bar{f}_1 \wedge \cdots \wedge d\bar{f}_n = \overline{J_f(z)} d\bar{z}_1 \wedge \cdots \wedge d\bar{z}_n. \quad (5)$$

Further, by the same properties

$$dz_\nu \wedge d\bar{z}_\nu = (dx_\nu + idy_\nu) \wedge (dx_\nu - idy_\nu) = -2idx_\nu \wedge dy_\nu$$

and analogously  $df_\nu \wedge d\bar{f}_\nu = -2idu_\nu \wedge dv_\nu$ , where  $f_\nu = u_\nu + iv_\nu$ . Therefore, multiplying out (4) and (5) and making the same rearrangements in the right- and left-hand sides, we obtain

$$\begin{aligned} du_1 \wedge \cdots \wedge du_n \wedge dv_1 \wedge \cdots \wedge dv_n \\ = |J_f(z)|^2 dx_1 \wedge \cdots \wedge dx_n \wedge dy_1 \wedge \cdots \wedge dy_n. \end{aligned}$$

But the quotient of the products of all  $2n$  real differentials  $du_1 \wedge \cdots \wedge dv_n$  and  $dx_1 \wedge \cdots \wedge dy_n$  is the quotient of the volume elements in the image and pre-image, i.e., is equal to the Jacobian  $J'_f$  of the mapping  $f$  considered as a real mapping. We have proved

**THEOREM 1.** *If  $f: U \rightarrow \mathbb{C}^n$  is a holomorphic mapping of a neighborhood of a point  $z \in \mathbb{C}^n$ , then the Jacobian of  $f$ , considered as a mapping of a neighborhood from  $\mathbb{R}^{2n}$  into  $\mathbb{R}^{2n}$ , is equal to the square of the modulus of the complex Jacobian:*

$$J'_f(z) = |J_f(z)|^2. \quad (6)$$

From this theorem we get complex variants of the inverse and implicit function theorems.

**THEOREM 2.** *Let  $U \subset \mathbb{C}^n$  be a neighborhood of a point  $z^0$  and let  $f: U \rightarrow \mathbb{C}^n$  be a holomorphic mapping. If the Jacobian  $J_f(z^0) \neq 0$ , then  $f$  is one-to-one in a neighborhood  $V \subset U$  of the point  $z^0$  and the inverse mapping  $g = f^{-1}$  is holomorphic at the point  $w^0 = f(z^0)$ . In addition the matrix  $g'(w)$  is the inverse to the matrix  $f'(z)$  for all  $z \in V$  and  $w = f(z)$ .*

◀ Since by Theorem 1 the real Jacobian  $J'_f(z^0) \neq 0$ , then the facts that  $f$  is locally one-to-one and that  $g = f^{-1}$  is of class  $C^\infty$  in a neighborhood of  $w^0$  follow from the inverse function theorem in real analysis. From the identity  $g \circ f(z) \equiv z$ , valid in  $V$ , by the theorem on the differentiation of a composite function we will obtain for  $j, k = 1, \dots, n$

$$\frac{\partial z_j}{\partial \bar{z}_k} = \sum_{\nu=1}^n \frac{\partial g_j}{\partial w_\nu} \frac{\partial f_\nu}{\partial \bar{z}_k} + \sum_{\nu=1}^n \frac{\partial g_j}{\partial \bar{w}_\nu} \frac{\partial \bar{f}_\nu}{\partial z_k} = 0.$$

But  $\partial f_\nu / \partial \bar{z}_k = 0$  since  $f$  is holomorphic, and  $\det(\partial \bar{f}_\nu / \partial z_k) = \overline{J_f(z)} \neq 0$  if  $V$  is sufficiently small; therefore  $\partial g_j / \partial \bar{w}_\nu = 0$  for all  $j, \nu = 1, \dots, n$ . Analogously (by differentiating with respect to  $z_k$ ) we obtain that  $g'(w) = (f'(z))^{-1}$ . ►

**THEOREM 3.** *If the functions  $f_1, \dots, f_k$  ( $k < n$ ) are holomorphic in a neighborhood of a point  $z^0 \in \mathbb{C}^n$  and  $\det(\partial f_\mu / \partial z_\nu) \neq 0$  in that neighborhood ( $\mu, \nu = 1, \dots, k$ ), then the system of equations  $f_1(z) = \dots = f_k(z) = 0$  is locally solvable relative to the points  $z_1, \dots, z_k$  and the solution  $z_\nu = g_\nu(z_{k+1}, \dots, z_n)$  ( $\nu = 1, \dots, k$ ) is holomorphic in a neighborhood of the point  $(z_{k+1}^0, \dots, z_n^0)$ .*

◀ As in the preceding theorem the solvability of the system and the smoothness of the solution follow from real analysis. Therefore in a neighborhood of  $(z_{k+1}^0, \dots, z_n^0)$  the identities  $f_\mu(g_1, \dots, g_k, z_{k+1}, \dots, z_n) = 0$  ( $\nu = 1, \dots, k$ ) are valid and they can be differentiated with respect to  $\bar{z}_j$  ( $j = k+1, \dots, n$ ):

$$\sum_{\nu=1}^k \frac{\partial f_\mu}{\partial z_\nu} \frac{\partial g_\nu}{\partial \bar{z}_j} + \sum_{\nu=1}^k \frac{\partial f_\mu}{\partial \bar{z}_\nu} \frac{\partial \bar{g}_\nu}{\partial z_j} + \frac{\partial f_\mu}{\partial \bar{z}_j} = 0, \quad \mu = 1, \dots, k.$$

But  $\partial f_\mu / \partial \bar{z}_\nu = \partial f_\mu / \partial \bar{z}_j = 0$  since the functions  $f_\mu$  are holomorphic, and  $\det(\partial f_\mu / \partial z_\nu) \neq 0$  by hypothesis; hence,  $\partial g_\nu / \partial \bar{z}_j = 0$  for  $\nu = 1, \dots, k$  and  $j = k+1, \dots, n$ . ►

We also note an extension to the higher-dimensional case of the criterion for local homeomorphy: along with Theorem 2 we have the following inverse to it.

**THEOREM 4.** *Let  $U \subset \mathbb{C}^n$  be a neighborhood of a point  $z^0$  and  $f: U \rightarrow \mathbb{C}^n$  a holomorphic mapping. If  $f$  is one-to-one in a neighborhood of  $z^0$ , then the Jacobian  $J_f(z^0) \neq 0$ .*

◀ We use induction on  $n$ . For  $n = 1$  the theorem is proved in Part I (see subsection 35); suppose it is true for all dimensions less than  $n$ . Assume that  $J_f(z^0) = 0$ , and denote by  $k$  ( $0 \leq k \leq n-1$ ) the rank of the matrix  $f'(z^0)$ . If  $k > 0$ , then without loss of generality we may assume that  $\det(\partial f_\mu / \partial z_\nu) \neq 0$  ( $\mu, \nu = 1, \dots, k$ ). Then by Theorem 3 the system of equations  $f_1(z) = w_1, \dots, f_k(z) = w_k$  is locally solvable relative to  $z_1, \dots, z_k$  in holomorphic functions and, consequently, in some neighborhood  $V \subset U$  we can take  $z'_\nu = f_\nu(z)$  for  $\nu = 1, \dots, k$  and  $z'_\nu = z_\nu$  for  $\nu = k+1, \dots, n$  as new local coordinates.

In the new coordinates (we again denote them by  $z_\nu$ ) the mapping  $f$  has the form  $w_\nu = z_\nu$  ( $\nu = 1, \dots, k$ ),  $w_\nu = f_\nu(z)$  ( $\nu = k+1, \dots, n$ ), and

the Jacobian

$$\begin{aligned}
 J_f(z) &= \det \left( \begin{array}{ccc|ccc}
 1 & 0 & \dots & 0 & & \\
 \dots & & & & & 0 \\
 0 & 0 & \dots & 1 & & \\
 \hline
 \frac{\partial f_{k+1}}{\partial z_1} & & \dots & & \frac{\partial f_{k+1}}{\partial z_{k+1}} & \dots & \frac{\partial f_{k+1}}{\partial z_n} \\
 \dots & & & & \dots & & \dots \\
 \frac{\partial f_n}{\partial z_1} & & \dots & & \frac{\partial f_n}{\partial z_{k+1}} & \dots & \frac{\partial f_n}{\partial z_n}
 \end{array} \right) \quad (7) \\
 &= \det \left( \begin{array}{ccc}
 \frac{\partial f_{k+1}}{\partial z_{k+1}} & \dots & \frac{\partial f_{k+1}}{\partial z_n} \\
 \dots & & \dots \\
 \frac{\partial f_n}{\partial z_{k+1}} & \dots & \frac{\partial f_n}{\partial z_n}
 \end{array} \right),
 \end{aligned}$$

so that at  $z^0$  the last determinant is equal to 0. Under  $f$  the plane  $\Pi = \{z_1 = \dots = z_k = 0\}$  of dimension  $n - k$  is mapped to the plane  $\{w_1 = \dots = w_k = 0\}$ , and hence, the restriction  $\tilde{f} = (f_{k+1}, \dots, f_n)|_{\Pi}$  maps the  $(n - k)$ -dimensional neighborhood  $\tilde{V} = V \cap \Pi$  into  $\mathbb{C}^{n-k}$  holomorphically. The Jacobian of this mapping at the point  $(z_{k+1}^0, \dots, z_n^0)$  is equal to 0 according to (7), and by the induction hypothesis  $\tilde{f}$  is not one-to-one in  $\tilde{V}$ . But then  $f$  is not one-to-one in  $V$ .

It remains to consider the case  $k = 0$ , when all the  $\partial f_{\mu} / \partial z_{\nu} = 0$  at  $z^0$ . We use the property which states that a holomorphic function of several variables cannot have isolated zeros: for any point where it is equal to 0 there is a smooth path with end at this point on which it is also equal to 0 (see subsection 23 below). Since  $J_f(z^0) = 0$ , by this property there exists a path  $\gamma$  with end  $z^0$  on which  $J_f(z) = 0$ . There are only two possibilities: (a) all the  $\partial f_{\mu} / \partial z_{\nu} \equiv 0$  on some segment of  $\gamma$  abutting to  $z^0$ , and (b) arbitrarily close to  $z^0$  there is a point on  $\gamma$  where not all  $\partial f_{\mu} / \partial z_{\nu} = 0$ . In case (a) the mapping  $f$  transforms this segment of  $\gamma$  into a point, and in case (b) close to  $z^0$  there is a point where  $J_f(z) = 0$  but  $\text{rank } f'(z) = k > 0$ . In both cases  $f$  is not one-to-one in a neighborhood of  $z^0$  (in case (b) this follows by what was proved above). ►

Furthermore, a maximum principle is valid for holomorphic mappings. In order to obtain it in a sufficiently general form, we call a  $\mathbb{C}$ -homogeneous

norm in  $\mathbb{C}^n$  a mapping  $\|\cdot\|: \mathbb{C}^n \rightarrow \mathbb{R}_+$  such that: (1)  $\|z+w\| \leq \|z\| + \|w\|$  for all  $z, w \in \mathbb{C}^n$ ; (2)  $\|\lambda z\| = |\lambda| \cdot \|z\|$  for all  $\lambda \in \mathbb{C}$  and all  $z \in \mathbb{C}^n$ , and (3)  $\|z\| = 0$  if and only if  $z = 0$ . The main examples of  $\mathbb{C}$ -homogeneous norms are the Euclidean and polydisc norms (see subsection 1).

**THEOREM 5 (maximum principle).** *Let  $D$  be a domain in  $\mathbb{C}^n$ ,  $f: D \rightarrow \mathbb{C}^m$  a holomorphic mapping, and  $\|\cdot\|$  some  $\mathbb{C}$ -homogeneous norm in  $\mathbb{C}^m$ . If  $\|f(z)\|$  attains a maximum at a point  $a \in D$ , then: (1) the components  $f_\mu$  of  $f$  are linearly dependent in  $D$ , and (2)  $\|f(z)\| = \text{const}$  in  $D$ .*

◀ Let  $b = f(a)$  and let  $B = \{w \in \mathbb{C}^m : \|w\| < \|b\|\}$  be a ball in the norm under consideration; in view of the properties of the norm this is a convex open set. For  $\|b\| = 0$  the assertion is trivial, so that we may assume  $\|b\| > 0$ . Then  $b \in \partial B$ ; since  $B$  is convex, in it there exists a supporting real hyperplane to  $B$ , which we can write

$$\text{Re}l(w) = \beta, \quad (8)$$

where  $l(w) = \sum_{\mu=1}^m a_\mu w_\mu$  is a complex linear function and  $\beta = \text{Re}l(b)$ . The function  $l$  can be chosen so that  $\text{Re}l(w) < \beta$  for all  $w \in B$ .

We now consider the function  $e^{l \circ f}$  which is holomorphic in  $D$ ; we have  $|e^{l \circ f(z)}| = e^{\text{Re}l \circ f(z)} \leq e^\beta$  everywhere in  $D$ , and at the point  $a$  its modulus is equal to  $e^\beta$ . By the maximum modulus principle (Theorem 6 from subsection 5)  $l \circ f(z) \equiv \text{const}$  in  $D$ . From this we conclude that the components  $f_\mu$  of  $f$  are linearly dependent (they satisfy the relation  $\sum_{\mu=1}^m a_\mu f_\mu(z) \equiv \text{const}$ ) and that  $f(z)$  for all  $z \in D$  belongs to the intersection of the support hyperplane (8) and the boundary  $\partial B$ , i.e.,  $\|f(z)\| = \|b\|$  for all  $z \in D$ . ▶

**REMARK.** If the ball  $B$  in the norm under consideration is a strictly convex set, then the intersection of the support hyperplane (8) with  $\partial B$  is a point, and then under the hypotheses of the theorem  $f(z) \equiv \text{const}$  (this happens, for example, in the Euclidean norm). In the case of a general  $\mathbb{C}$ -homogeneous norm this conclusion is not true (for example, in the case of the polydisc norm).

From the maximum principle we can derive one possible generalization of the SCHWARZ LEMMA:

**THEOREM 6.** *Let  $B_1 \subset \mathbb{C}^n$  and  $B_2 \subset \mathbb{C}^m$  be unit balls in the  $\mathbb{C}$ -homogeneous norms  $\|\cdot\|_1$  and  $\|\cdot\|_2$  respectively, and let  $f: B_1 \rightarrow B_2$  be a holomorphic mapping such that  $f(0) = 0$ . Then, for any  $z \in B_1$ ,*

$$\|f(z)\|_2 \leq \|z\|_1. \quad (9)$$

◀ We draw a complex line  $l: z = \zeta z^0$  through the point  $0 \in \mathbb{C}^n$ , where  $z^0 \in \partial B_1$  (i.e.,  $\|z^0\|_1 = 1$ ) and  $\zeta \in \mathbb{C}$ ; its intersection with  $B_1$  in the  $\zeta$ -plane obviously corresponds to the disc  $U = \{|\zeta| < 1\}$ . We consider the holomorphic curve  $g(\zeta) = f(\zeta z^0)/\zeta: U \rightarrow \mathbb{C}^m$  and fix an arbitrary  $r$ ,  $0 < r < 1$ . By Theorem 2 we have  $\|g(\zeta)\|_2 \leq 1/r$  in the disc  $\{|\zeta| \leq r\}$ , and



passing to the limit as  $r \rightarrow 1$ , we find that  $\|g(\zeta)\|_2 \leq 1$ , i.e.,  $\|f(\zeta z^0)\|_2 \leq |\zeta|$  at any point  $\zeta \in U$ .

Now suppose  $z \neq 0$  is an arbitrary point of  $B_1$ ; then  $z^0 = z/\|z\|_1 \in \partial B_1$  and, setting  $\zeta = \|z\|_1$  in the last inequality, we will obtain (9). ►

We will consider other generalizations of Schwarz's lemma in Chapter V.

\* Prove that if we have equality in (9) for some point  $z^0 \in B_1 \setminus \{0\}$ , then  $\|f(z)\|_2 = \|z\|_1$  also for all points of the complex line  $l$  passing through 0 and  $z^0$ . \*

### 10. Biholomorphic mappings.

DEFINITION. A mapping  $f$  of a domain  $D \subset \mathbb{C}^n$  is said to be *biholomorphic* if it is holomorphic in  $D$  and has an inverse mapping  $g = f^{-1}$  that is holomorphic in the domain  $G = f(D)$  (hence it follows from topological considerations that  $f$  preserves dimension).

In the preceding subsection we saw that the Jacobian  $J_f(z) \neq 0$  if and only if  $f$  is locally biholomorphic at the point  $z$ . In particular, it follows from this that any holomorphic one-to-one mapping  $f: D \rightarrow f(D)$  is biholomorphic.<sup>(14)</sup> For  $n > 1$  the property of being biholomorphic is not the same as being conformal. For example, in  $\mathbb{C}^2$  the mapping  $(z_1, z_2) \rightarrow (z_1, 2z_2)$  is biholomorphic but not conformal, and the conformal mapping  $z \rightarrow z/|z|^2$  is neither holomorphic nor antiholomorphic.

EXAMPLE. It is convenient to give certain mappings in the spaces  $\mathbb{C}^{n^2}$  by  $n \times n$  matrices. For example, we consider the so-called *Cayley transform*:

$$W = (Z + iE)^{-1}(Z - iE), \quad (1)$$

where  $Z$  is an arbitrary  $n \times n$  matrix and  $E$  is the  $n \times n$  identity matrix. We shall show that it maps the generalized upper half-plane  $H = \{Z \in \mathbb{C}^{n^2} : \text{Im } Z > 0\}$  from Example 8 of subsection 2 biholomorphically onto the domain

$$D = \{W \in \mathbb{C}^{n^2} : WW^* < E\}, \quad (2)$$

which is called the *generalized unit disc*.<sup>(15)</sup>

First of all we remark that for  $Z \in H$  the matrix  $Z + iE$  is nondegenerate. In fact, if  $w$  is a column vector of length  $n$  and  $(Z + iE)w = 0$ , then  $Zw = -iw$ , from which we see that  $w^*Z^* = iw^*$ ; thus,  $w^*Zw = -iw^*w$ ,  $w^*Z^*w = iw^*w$ , and  $w^*\text{Im } Z w = -w^*w$ . Since  $\text{Im } Z > 0$ , the left-hand side here will be positive for  $w \neq 0$ ,<sup>(16)</sup> and the right-hand side is equal to  $-|w|^2$  and thus is negative, so that  $w = 0$ . This proves that the matrix  $Z + iE$  is nondegenerate, i.e., the existence of  $(Z + iE)^{-1}$  and that the mapping (1) is holomorphic in  $H$ .

<sup>(14)</sup>For  $J_f(z) \neq 0$  the fact that  $f^{-1}$  is holomorphic at  $w = f(z)$  follows from the inverse function theorem.

<sup>(15)</sup>Here we denote by  $W^*$  the matrix obtained from  $W$  by conjugation and transposition; the condition  $WW^* < E$  means that the Hermitian matrix  $E - WW^*$  is positive definite. Further we also use the well-known matrix relations  $(AB)^* = B^*A^*$  and  $(AB)^{-1} = B^{-1}A^{-1}$ .

<sup>(16)</sup>Here we have used a well-known fact: the Hermitian matrices  $A$  and  $BAB^*$  are simultaneously positive definite if  $B$  is nondegenerate.

Further, from (1) we get the relation

$$\begin{aligned} E - WW^* &= E - (Z + iE)^{-1}(Z - iE)(Z^* + iE)(Z^* - iE)^{-1} \\ &= (Z + iE)^{-1}\{(Z + iE)(Z^* - iE) - (Z - iE)(Z^* + iE)\}(Z^* - iE)^{-1} \quad (3) \\ &= (Z + iE)^{-1}4\text{Im } Z(Z^* - iE)^{-1}, \end{aligned}$$

from which we see that if  $Z + iE$  is nondegenerate then the Hermitian matrices  $E - WW^*$  and  $\text{Im } Z$  are simultaneously positive definite. We have proved that (1) maps  $H$  into  $D$ .

From (1) it is simple to find the inverse mapping

$$Z = i(E + W)(E - W)^{-1} \quad (4)$$

and it is holomorphic in  $D$ , since for  $W \in D$  the matrix  $E - W$  is nondegenerate (this is proved as above). But from (3) we see that for  $W \in D$  the matrix  $(Z + iE)^{-1}$  is also nondegenerate, and hence  $\text{Im } Z > 0$ , i.e., (4) maps  $D$  into  $H$ . This proves the assertion.

The reader will have of course noted the analogy between (1)–(4) and the formulas for linear-fractional mappings of the half-plane onto the disc from Part I. We note also that the mapping (1) transforms the skeleton  $\Gamma = \{\text{Im } Z = 0\}$  of the generalized upper half-plane onto the set  $\{WW^* = E\}$ , which consists of unitary matrices. It is also called the skeleton of the generalized unit disc and is its Shilov boundary.

Finally, we note that the generalized unit disc is a bounded domain. In fact, if we write  $w^j = (w_1^j, \dots, w_n^j)$  for the rows of the matrix  $W$ , then the elements of the principal diagonal of  $E - WW^*$  will be  $1 - |w^j|^2$ , and since this matrix is positive definite, all these elements are positive. Therefore  $|W|^2 = \sum |w^j|^2 < n$  and  $D$  lies inside the ball  $\{|W| < \sqrt{n}\}$ .

A biholomorphic mapping  $f: D \rightarrow G = f(D)$  is also called a (*holomorphic isomorphism*), and the domains  $D$  and  $G$ , for which such a mapping exists, are *biholomorphically equivalent*. A holomorphic isomorphism of a domain  $D$  onto itself is called a (*holomorphic automorphism*).

The set of holomorphic automorphisms of a domain  $D$  obviously forms a group relative to composition, which is denoted by  $\text{Aut } D$ . As in subsection 38 of Part I, one proves that any biholomorphic mapping  $f: D \rightarrow G = f(D)$  establishes an isomorphism of groups  $f_*: \text{Aut } D \rightarrow \text{Aut } G$  by the formula

$$f_*: \varphi \rightarrow f \circ \varphi \circ f^{-1}, \quad \varphi \in \text{Aut } D. \quad (5)$$

Thus, an isomorphism between the groups  $\text{Aut } D$  and  $\text{Aut } G$  is necessary for the domains  $D$  and  $G$  to be biholomorphically equivalent. However, this condition is not sufficient, as we see from the example of different plane annuli  $D = \{1 < |z| < r_1\}$  and  $G = \{1 < |z| < r_2\}$ ,  $r_1 \neq r_2$ , which are not conformally equivalent although their groups of automorphisms are isomorphic (see Problem 15 to Chapter IV of Part I).

We compute the groups of automorphisms of certain domains.

(a) *Automorphisms of the ball*  $B^n = \{z \in \mathbb{C}^n : |z| < 1\}$ . First we construct an automorphism that takes a fixed point  $a \in B^n \setminus \{0\}$  to the center  $z = 0$ . For this we denote by  $p_a(z) = (z, a)a/|a|^2$  the projection of an arbitrary point  $z \in B^n$  onto the complex line  $l_a$  passing through  $a$  and  $0$ , and by  $q_a(z) = z - p_a(z)$  the projection of this point onto the orthogonal comple-

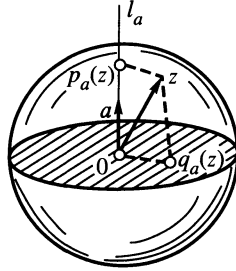

FIGURE 11

ment to  $l_a$  (see the diagram in Figure 11). We shall prove that the desired automorphism is

$$L_a: w = \frac{a - p_a(z) - \alpha q_a(z)}{1 - (z, a)}, \quad (6)$$

where  $\alpha = \sqrt{1 - |a|^2}$ .

First of all it is clear that the denominator of this formula does not vanish in  $B^n$ , since by the Schwarz inequality  $|(z, a)| \leq |a||z| < 1$ , and hence the mapping  $L_a$  is holomorphic in  $B^n$ . Since  $p_a(a) = a$  and  $q_a(a) = 0$ , we have that  $L_a(a) = 0$ . In what follows it is convenient to assume without loss of generality that the  $z_n$ -axis is directed along the vector  $a$ , i.e., that  $a = (0, a_n)$ . Then

$$p_a(z) = (0, z_n), \quad q_a(z) = (z, 0),$$

and (6) takes the form

$$w = -\alpha \frac{z}{1 - \bar{a}_n z_n}, \quad w_n = \frac{a_n - z_n}{1 - \bar{a}_n z_n}. \quad (7)$$

A simple calculation shows that

$$|w|^2 = \frac{|z|^2 + |a_n|^2(1 - |z|^2) - 2\operatorname{Re}(\bar{a}_n z_n)}{1 + |\bar{a}_n z_n|^2 - 2\operatorname{Re}(\bar{a}_n z_n)},$$

from which we see that if  $|z| < 1$  we also have  $|w| < 1$ , and if  $|z| = 1$  then  $|w| = 1$ . Thus,  $L_a$  maps  $B^n$  onto  $B^n$ . An equally simple calculation using formula (7) shows that the composition of two mappings  $L_a$  is the identity mapping:  $L_a \circ L_a(z) \equiv z$ . From this we see that the equality  $L_a(z') = L_a(z'')$  reduces to  $z' = z''$ , i.e., the mapping  $L_a$  is biholomorphic; by what is proved above it is an automorphism of  $B^n$ .

It is clear that an automorphism of  $B^n$  taking  $a$  to 0 is also given by the composition

$$G_a = U \circ L_a, \quad (8)$$

where  $U$  is an arbitrary unitary transformation in  $\mathbb{C}^n$ . We will now prove that these are all the automorphisms of the ball.

**THEOREM 1.** *Any biholomorphic automorphism of the ball  $B^n$  has the form (8) for a suitable choice of the point  $a \in B^n$  and the unitary transformation  $U$ .*

◀ Let  $f: B^n \rightarrow B^n$  be an arbitrary automorphism and let  $a$  be the (unique) point that it maps to 0. Then the composition  $g = f \circ L_a^{-1}$  and the inverse  $g^{-1}$  will be holomorphic mappings of  $B^n$  into  $B^n$ , preserving the center. Applying the Schwarz lemma from the previous subsection to each of them in the Euclidean metric, we find that everywhere in  $B^n$  we have  $|g(z)| \leq |z|$  and  $|g^{-1}(w)| \leq |w|$ . Setting  $w = g(z)$  in the second inequality, we find that  $|z| \leq |g(z)|$ , and, combining this with the first inequality, we obtain that everywhere in  $B^n$  we have

$$|g(z)| \equiv |z|. \quad (9)$$

Now we fix a point  $z^0 \in \partial B^n$  and in the disc  $\{|\zeta| < 1\} \subset \mathbb{C}$  we consider the vector-function  $G(\zeta) = g(\zeta z^0)/\zeta$ . Since  $\zeta z^0 \in B^n$  and  $g(0) = 0$  for  $|\zeta| < 1$ , the function  $G$  is holomorphic in the disc  $\{|\zeta| < 1\}$ . But by (9) we have

$$|G(\zeta)| = |g(\zeta z^0)|/|\zeta| \equiv |z_0| \quad \text{for all } \zeta, 0 < |\zeta| < 1,$$

so that by the maximum principle of the previous subsection, taking into account the strict convexity of the sphere in  $\mathbb{C}^n$ , we conclude that  $G(\zeta) = c(z^0)$  is a constant depending only on  $z^0$  (see the remark following Theorem 5 in subsection 9).

Thus,  $g(\zeta z^0) = c(z^0)\zeta$ , from which we can conclude that the function  $g$  is linear on the intersection of  $B^n$  with each complex line  $z = z^0\zeta$  passing through 0:

$$g(\lambda z) = \lambda g(z), \quad \lambda \in \mathbb{C}, \quad |\lambda| < 1. \quad (10)$$

On the other hand, expanding the coordinates of  $g$  in a series in homogeneous polynomials, we obtain an expansion of  $g$  in vector homogeneous polynomials

$$g(z) = \sum_{\nu=0}^{\infty} P_{\nu}(z).$$

From this, taking (10) into account we obtain, for any  $\lambda \in \mathbb{C}$ ,  $|\lambda| < 1$ ,

$$g(\lambda z) = \sum_{\nu=0}^{\infty} \lambda^{\nu} P_{\nu}(z) = \lambda \sum_{\nu=0}^{\infty} P_{\nu}(z).$$

By the uniqueness of the power series expansion in  $\lambda$  we conclude that all the  $P_{\nu}$ , except for  $P_1$ , are identically equal to zero. Thus,  $g$  is linear, and then by (9) it is a unitary transformation:  $g = f \circ L_a^{-1} = U$ . Thus,  $f = U \circ L_a$ , i.e., has the form (8). ▶

<sup>(17)</sup>In fact,  $g(\lambda z^0 \zeta) = c(z^0)\lambda \zeta = \lambda g(\zeta z^0)$ .

Now it is easy to compute the number of parameters on which the group  $\text{Aut } B^n$  depends. The mapping  $L_a$  is determined by the point  $a$ , i.e., depends on  $2n$  real parameters. The unitary transformation  $U$  has the form  $w = Az$ , where  $A$  is a unitary matrix, i.e.,  $AA^* = E$ , and this condition leads to  $n^2$  real relations. In fact, if  $A = (a_{\mu\nu})$ , then the condition of unitarity is expressed by the equalities  $\sum_{j=1}^n a_{j\mu} \bar{a}_{j\nu} = \delta_{\mu\nu}$ , where  $\delta_{\mu\nu}$  is the Kronecker symbol; there are  $n^2$  of these equalities, where  $n$  of them are real (for  $\mu = \nu$ ), and the remainder are complex conjugates of each other (by permuting  $\mu$  and  $\nu$ ), so that there are  $(n^2 - n)/2$  independent complex conditions, i.e.,  $n^2 - n$  real ones. Thus, the group  $\text{Aut } B^n$  depends on  $n^2 + 2n$  real parameters.

We also note that the group  $\text{Aut } B^n$  acts transitively, i.e., there exists an automorphism taking any point  $a$  into any other point  $b$ . For example, such an automorphism is  $L_b^{-1} \circ L_a$ , where  $L_a$  and  $L_b$  are defined by formula (6) and the one obtained from it by replacing  $a$  by  $b$ .

\* Prove that a unitary transformation in  $\mathbb{C}^2$  can be written in the form

$$(z_1, z_2) \rightarrow \frac{1}{\sqrt{1 + |\lambda|^2}} (e^{i\theta_1}(z_1 + \lambda z_2), e^{i\theta_2}(\bar{\lambda} z_1 - z_2)),$$

where  $\lambda$  is a complex number and  $\theta_1$  and  $\theta_2$  are real. \*

(b) Automorphisms of the polydisc  $U^n = \{z \in \mathbb{C}^n : \|z\| < 1\}$ . The group of linear-fractional automorphisms

$$w_\nu = e^{i\theta_\nu} \frac{z_\nu - a_\nu}{1 - \bar{a}_\nu z_\nu}, \quad \nu = 1, \dots, n, \quad (11)$$

obviously acts in  $U^n$ . This group depends on  $3n$  real parameters ( $\theta_\nu$  are real and  $a_\nu$  are complex constants). For  $n > 1$  we can add to them the transformations  $w_\nu \rightarrow w_{\sigma(\nu)}$  which permute the variables, where  $\sigma$  is a one-to-one mapping of the set  $(1, \dots, n)$  onto itself. Thus, we have found a group of automorphisms of  $U^n$ , which is stratified into  $n!$  sets depending on  $3n$  real parameters.<sup>(18)</sup> It turns out that this is the group of automorphisms of  $U^n$ :

**THEOREM 2.** The group  $\text{Aut } U^n$  consists of transformations of the form

$$z_\nu \rightarrow e^{i\theta_{\sigma(\nu)}} \frac{z_{\sigma(\nu)} - a_{\sigma(\nu)}}{1 - \bar{a}_{\sigma(\nu)} z_{\sigma(\nu)}} \quad (\nu = 1, \dots, n), \quad (12)$$

where  $\sigma$  is an arbitrary permutation of the set  $(1, \dots, n)$ .

◀ Let  $f \in \text{Aut } U^n$  and  $a = f(0)$ ; choosing  $g$  according to the formula (11), we obtain that  $F = g \circ f$  is a biholomorphic mapping of  $U^n$  onto itself such that  $F(0) = 0$ . Applying the Schwarz lemma in the polydisc metric to

<sup>(18)</sup>Among these sets only the one that contains the identity transformation, i.e., the set of transformations (11), is itself a group.

$F$  and to  $F^{-1}$ , we will find, as in the preceding theorem, that

$$\|F(z)\| \equiv \|z\| \quad (13)$$

for all  $z \in U^n$ .

We consider an arbitrary coordinate  $F_\nu$  of the mapping  $F$ ; since  $\|F\| = \max|F_\mu|$  and  $F(U^n) = U^n$ , then in  $U^n$  there is a neighborhood where  $\|F(z)\| = |F_\nu(z)|$ . Let  $\|z\| = |z_\mu|$  in the corresponding neighborhood of the pre-image under the mapping  $F$ . Applying the Schwarz lemma for functions of one variable to  $F_\nu$  as a function of  $z_\mu$ , we obtain from the equality  $|F_\nu(z)| = |z_\mu|$ , which follows from (13), that  $F_\nu(z) = e^{i\theta(z)} z_\mu$ . Here  $\theta$  may depend on  $z_j$  ( $j \neq \mu$ ), but since  $e^{i\theta(z)}$  is a holomorphic function of constant modulus, it is constant (see the remark after Theorem 5 in subsection 9), and in fact  $\theta(z) = \theta_\mu = \text{const}$ . Thus,  $F_\nu(z) = e^{i\theta_\mu} z_\mu$  in some neighborhood, and by the uniqueness theorem, in all of  $U^n$ .

Finally, since  $F$  is a homeomorphism it follows that  $\mu = \mu(\nu)$  is a permutation of the indices  $(1, \dots, n)$ . We have proved that  $f = g^{-1} \circ F$  is a transformation of the form (12). ►

The groups  $\text{Aut } B^n$  and  $\text{Aut } U^n$  coincide for  $n = 1$ , but for  $n > 1$  they are obviously not isomorphic. From what was stated at the beginning of this subsection it follows that for  $n > 1$  the ball  $B^n$  and the polydisc  $U^n$  are not biholomorphically equivalent.<sup>(19)</sup> We will also give a direct proof of this assertion.

**THEOREM 3.** *For  $n > 1$  there does not exist a biholomorphic mapping of the ball  $B^n$  onto the polydisc  $U^n$ .*

◄ Suppose that, on the contrary, such a mapping  $f: B^n \rightarrow U^n$  exists. Applying an automorphism of  $U^n$  if necessary, we may assume that  $f(0) = 0$ . Applying the Schwarz lemma from subsection 9 to  $f$  and  $f^{-1}$ , we find, as in the preceding proofs, that  $\|f(z)\| \equiv \|z\|$  for all  $z \in B^n$ . From this it follows that the Euclidean sphere  $\{|z| = 1/2\}$  is mapped to the nonsmooth surface  $\{\|z\| = 1/2\}$  under  $f$ , which is impossible since  $f$  is a diffeomorphism. ►

We see that Riemann's theorem on the biholomorphic equivalence of simply connected domains of the plane does not extend to the higher-dimensional case. This is related to the **OVERDETERMINEDNESS** of the conditions of holomorphy for  $n > 1$ : for mappings  $f = (f_1, \dots, f_n)$  of domains of  $\mathbb{C}^n$  the Cauchy-Riemann conditions  $\partial f_\mu / \partial \bar{z}_\nu = 0$  consist of  $n^2$  complex differential equations relative to  $n$  unknown complex functions.

(c) *Automorphisms of the generalized upper half-plane*  $H = \{Z \in \mathbb{C}^{n^2} : \text{Im } Z > 0\}$ . We first explain the conditions under which the matrix linear-fractional function

$$W = (AZ + B)(CZ + D)^{-1} \quad (14)$$

<sup>(19)</sup>This important fact was discovered by HENRI POINCARÉ (1854–1912) in 1907.

preserves the sign of  $\text{Im } Z$ . The elementary identity

$$\begin{aligned} \text{Im } W &= \frac{1}{2i}[(AZ + B)(CZ + D)^{-1} - (Z^*C^* + D^*)^{-1}(Z^*A^* + B^*)] \\ &= \frac{1}{2i}(Z^*C^* + D^*)^{-1}[(Z^*C^* + D^*)(AZ + B) \\ &\quad - (Z^*A^* + B^*)(CZ + D)](CZ + D)^{-1} \\ &= \frac{1}{2i}(Z^*C^* + D^*)^{-1}[Z^*(C^*A - A^*C)Z + (D^*A - B^*C)Z \\ &\quad + Z^*(C^*B - A^*D) + D^*B - B^*D](CZ + D)^{-1} \end{aligned}$$

shows that for this the following conditions are sufficient:

$$C^*A = A^*C, \quad D^*B = B^*D, \quad D^*A - B^*C = E, \quad (15)$$

and the nondegeneracy of the matrix  $CZ + D$ . In fact, under these conditions we also have  $C^*B - A^*D = -E$  and the preceding identity takes the form

$$\text{Im } W = (Z^*C^* + D^*)^{-1} \text{Im } Z (CZ + D)^{-1}, \quad (16)$$

from which it is clear that the Hermitian matrices  $\text{Im } Z$  and  $\text{Im } W$  are simultaneously positive or are equal to zero.

We denote by  $\Gamma$  the set of biholomorphic automorphisms of  $H$  of the form (14) with coefficients satisfying the conditions (15). An elementary computation shows that under the composition of two mappings from  $\Gamma$  the matrices of coefficients of formula (14) are multiplied together, and the coefficients of the composition again satisfy the conditions (15). Therefore  $\Gamma$  forms a group under the operation of composition of mappings. According to (16) the mappings from  $\Gamma$  transform Hermitian matrices  $Z$  (for which  $\text{Im } Z = 0$ ) into Hermitian matrices, i.e., they preserve the skeleton of the domain  $H$ . However, we remark that the skeleton belongs not to  $H$  but to its boundary, so that some mappings from  $\Gamma$  may have singularities on the skeleton.

We distinguish a subgroup  $\Gamma_0 \subset \Gamma$  of *integer* mappings for which the coefficient  $C = 0$  in (14). From the last condition of (15) it follows that then  $A$  and  $D$  are nondegenerate matrices, and  $D^{-1} = A^*$ . Therefore, according to (14) the mappings from  $\Gamma_0$  have the form

$$W = AZA^* + BA^*, \quad \det A \neq 0. \quad (17)$$

Here  $A$  is an arbitrary (nondegenerate) matrix and  $BA^*$  is an arbitrary Hermitian matrix,<sup>(20)</sup> so that the group  $\Gamma_0$  depends on  $2n^2 + n^2 = 3n^2$  real parameters.

\* Prove that

(1) The group  $\Gamma_0$  acts transitively in  $H$ .

---

<sup>(20)</sup>The Hermiticity of  $BA^* = BD^{-1}$  follows from the middle condition of (15):  $BD^{-1} = (D^{-1})^*B^*$ .

(2) The domain  $H$  does not contain degenerate matrices. (HINT: if  $Z$  is degenerate, then there is a column vector  $a \neq 0$  such that  $Za = 0$ ; then we also have  $a^*Z^* = 0$ , and hence  $a^*\text{Im } Za = 0$ .)

(3) If the matrix  $C$  is nondegenerate for mappings from  $\Gamma$ , then  $C^{-1}D$  is Hermitian. (HINT: from (15) it follows that  $C^{-1}D = D^*AC^{-1}D - B^*D$ , and the matrices  $AC^{-1}$  and  $B^*D$  are Hermitian.) \*

We indicate another set of mappings from  $\Gamma$  for which the matrix  $C$  is nonzero and nondegenerate (this set does not form a group). If in (14) the matrix  $C$  is nondegenerate, then this formula can be rewritten in the form<sup>(21)</sup>

$$W = AC^{-1} + (B - AC^{-1}D)(CZ + D)^{-1},$$

and from the conditions (15) it follows that  $B - AC^{-1}D = -(C^{-1})^*$ . Therefore the mappings of this set have the form

$$W = AC^{-1} - (C^{-1})^*(Z + C^{-1}D)^{-1}C^{-1}, \quad (18)$$

where the matrices  $AC^{-1}$  and  $C^{-1}D$  are Hermitian. Conversely, any mapping of this form is an automorphism of  $H$ , i.e., belongs to our set. In fact, since  $C^{-1}D$  is a Hermitian matrix,  $\text{Im}(Z + C^{-1}D) = \text{Im } Z$ , and hence for all  $Z \in H$  the matrix  $Z + C^{-1}D \in H$ , and hence is nondegenerate (see the exercise). Therefore the mapping (18) is holomorphic in  $H$ ; obviously it maps  $H$  into  $H$ , and its inverse has the same form with  $C^{-1}D$  replaced by  $AC^{-1}$ . Thus, (18) maps  $H$  biholomorphically onto itself.<sup>(22)</sup>

\* 1. Verify that not every mapping from  $\Gamma$  in a coordinate representation is linear-fractional. (HINT: consider the example of inversion  $W = -Z^{-1}$ —a mapping of the form (18), where  $C = E$  and  $A = D = 0$ .)

2. Consider the example of a mapping (14) with the matrices  $A = D = E$ ,  $B = 0$ , and  $C = \begin{pmatrix} 1 & 0 \\ 0 & 0 \end{pmatrix}$ . Show that it belongs to  $\Gamma$ , but does not belong either to  $\Gamma_0$  or to the set of mappings of the form (18). \*

We now consider the *isotropy subgroup* of the point  $Z^0 = iE$ , i.e., the set of mappings from  $\Gamma$  that leave this point fixed. According to (17) the mappings from  $\Gamma_0$  belong to this subgroup if  $iE = iAA^* + BD^{-1}$ ; passing to Hermitian conjugates here, we obtain  $-iE = -iAA^* + BD^{-1}$  and, combining this equality with the preceding one, we find that  $BD^{-1} = 0$  and  $AA^* = E$ . Thus, the mappings from  $\Gamma_0$  that leave the point  $iE$  fixed have the form

$$W = AZA^*, \quad (19)$$

where  $A$  is a unitary matrix.

For simplicity we rewrite the mappings from the set (18) in the form

$$W = B - C(Z + A)^{-1}C^*, \quad (20)$$

<sup>(21)</sup>This is verified by a direct computation: the right-hand side, multiplied on the right by  $CZ + D$ , is equal to  $AC^{-1}(CZ + D) + B - C^{-1}D = AZ + B$ .

<sup>(22)</sup>We remark that the mapping (18) is degenerate on the skeleton of  $H$  on the set of matrices which differ from  $-C^{-1}D$  by nondegenerate Hermitian additive terms.



where  $A$  and  $B$  are Hermitian, and  $C$  is a nondegenerate matrix. The condition that the point  $iE$  be fixed has the form  $iE = B - C(A + iE)^{-1}C^*$ ; from this and its Hermitian conjugate we find that

$$2B = C[(A + iE)^{-1} + (A - iE)^{-1}]C^*. \quad (21)$$

Multiplying the expression in square brackets, which we denote by  $X$ , by  $(A + iE)(A - iE) = (A - iE)(A + iE) = A^2 + E$ , we obtain  $X(A^2 + E) = 2A$ , whence  $X = 2A(A^2 + E)^{-1}$ . Substituting this in (21), we will find  $B = CA(A^2 + E)^{-1}C^*$ , and then the condition that the point  $iE$  be fixed, written above, takes the form

$$iE = C[A(A^2 + E)^{-1} - (A + iE)^{-1}]C^* = iC(A^2 + E)^{-1}C^*.$$

From this we find that  $B = CAC^{-1}$  and  $C^*C = A^2 + E$ , and hence (20) can be rewritten in the form  $W = C[A - (Z + A)^{-1}(A^2 + E)]C^{-1}$ , or finally

$$W = C(Z + A)^{-1}(ZA - E)C^{-1}. \quad (22)$$

By the rules of differentiating matrices we find from this that

$$W'(iE) = C(A + iE)^{-1}(A - iE)C^{-1}, \quad (23)$$

where the matrix  $(A + iE)^{-1}(A - iE) = U$  is unitary, i.e.,  $UU^* = E$ , as is not hard to check. We remark that from this for a given matrix  $U \neq E$  the matrix

$$A = i(E + U)(E - U)^{-1} \quad (24)$$

is uniquely determined.

\* Prove that the isotropy subgroup of the point  $i$  of the group of automorphisms of the usual upper half-plane  $\{z \in \mathbb{C} : \text{Im } z > 0\}$  consists of the mappings

$$w = \frac{az - 1}{z + a}, \quad a > 0, \quad w'(i) = \frac{a - i}{a + i}$$

(cf. formulas (22) and (23)). \*

To conclude we shall prove that the group  $\Gamma$  contains all the automorphisms of  $H$ . For this we need yet another result, which is of independent interest.

**THEOREM 4 (H. Cartan).** *Let  $D \subset \mathbb{C}^n$  be a bounded domain containing the point  $z = 0$  and let  $f: D \rightarrow D$  be a holomorphic mapping such that  $f(0) = 0$ . Then, if  $f'(0) = E$ ,  $f$  is the identity mapping.<sup>(23)</sup>*

◀ Suppose this is not so, and the Taylor expansion of  $f$  at  $z = 0$  has the form  $f(z) = z + P(z) + o(|z|^\alpha)$ , where  $P$  is a nonzero vector polynomial of degree  $\alpha \geq 2$ . Then iterations of  $f$  have the form  $f^{(2)}(z) = f \circ f(z) = z + P(z) + o(|z|^\alpha) + P(z + P(z) + o(|z|^\alpha)) = z + 2P(z) + o(|z|^\alpha)$  and more generally

$$f^{(\nu)}(z) = f \circ f^{(\nu-1)}(z) = z + \nu P(z) + o(|z|^\alpha). \quad (25)$$

<sup>(23)</sup>This result was published in 1932.

By hypothesis there is a  $k = (k_1, \dots, k_n)$ ,  $|k| = \alpha$ , such that the vector

$$c = \frac{1}{k!} \frac{d^\alpha P}{dz^k} = \frac{1}{k!} \frac{d^\alpha f}{dz^k}(0) \neq 0,$$

and hence some coordinate of it, say  $c_j = \frac{1}{k!} \frac{d^\alpha f_j}{dz^k}(0) \neq 0$ . Then, as we see from (25), for the  $\nu$ th iteration of  $f$  the Taylor coefficient

$$c_j^{(\nu)} = \frac{1}{k!} \frac{d^\alpha f_j^{(\nu)}}{dz^k}(0) = \nu c_j.$$

By hypothesis the domain  $D$  contains a polydisc  $\bar{U}_r = \{\|z\| \leq r\}$  and is contained in  $U_R = \{\|z\| < R\}$ . Therefore, for all iterations  $|f_j^{(\nu)}(z)| < R$  for all  $z \in U_r$  and by Cauchy's inequality,

$$|c_j^{(\nu)}| = \nu |c_j| \leq R/r^\alpha.$$

Since  $c_j \neq 0$ , then for sufficiently large  $\nu$  we are led to a contradiction. ►

**THEOREM 5.** *Any biholomorphic automorphism of a generalized upper half-plane is represented by a linear-fractional matrix function, i.e.,  $\text{Aut } H = \Gamma$ .*

◄ Suppose  $f \in \text{Aut } H$ ; according to the exercise on pp. 50–51 there is a mapping  $l_1 \in \Gamma_0$  taking  $f(iE)$  into  $iE$ , and then  $l_1 \circ f = f_1$  fixes the point  $iE$ . By a well-known theorem from algebra the nondegenerate matrix  $f_1'(iE)$  can be represented in the form  $BU$ , where  $B$  is positive Hermitian and  $U$  is a unitary matrix. If  $U \neq E$ , then we choose a matrix  $A$  by formula (24), and from this  $A$  by formula (22), where we also set  $C = E$ , we construct a mapping  $l_2 \in \Gamma$ . By formula (23) we have  $l_2'(iE) = U$ , so that the derivative of the composition  $f_2 = f_1 \circ l_2^{-1}$  at  $iE$  is equal to  $B$ ; in case  $U = E$  we take  $l_2(Z) \equiv Z$  and then  $f_2(iE) = iE$ ,  $f_2'(iE) = B$ .

Now let  $K: Z \rightarrow (Z + iE)^{-1}(Z - iE)$  be the Cayley transform, mapping  $H$  into the generalized unit disc  $D$  (see the example at the beginning of this subsection). We have  $K(iE) = 0$  and  $K'(iE) = E$ , and hence,  $g = K \circ f_2 \circ K^{-1}$  is an automorphism of  $D$  such that  $g(0) = 0$  and  $g'(0) = B$ . Since the matrix  $B$  is positive, all its eigenvalues  $\lambda_1, \dots, \lambda_n$  are positive, and for the  $\nu$ th iteration  $g^{(\nu)} = g \circ g^{(\nu-1)}$  the eigenvalues of the derivative of the matrix at 0 are equal to  $\lambda_1^\nu, \dots, \lambda_n^\nu$ .

But since  $D$  is a bounded domain, then by Montel's theorem the family of iterations  $g^{(\nu)}$  is compact, and in view of the normalization  $g^{(\nu)}(0) = 0$ , the limit of any subsequence of such iterations is a biholomorphic mapping.<sup>(24)</sup> Since for  $\lambda_j \neq 1$  the powers  $\lambda_j^\nu$  tend either to 0 or to  $\infty$ , which contradicts the biholomorphy of the limit mapping, then all the  $\lambda_j = 1$  and hence the

<sup>(24)</sup>This is a higher-dimensional analogue of the theorem of Hurwitz (section 39 of Part I); see Problem 3 of Chapter V.

matrix  $B = g'(0) = E$ . By Theorem 4 then  $g(Z) = Z$ , whence  $f_2$  is the identity mapping, i.e.,  $f = l_1^{-1} \circ l_2 \in \Gamma$ . ►

**REMARK.** Under the additional assumption that the automorphism  $f \in \text{Aut } H$  extends continuously to the closure  $\overline{H}$ , Theorem 5 can be proved in yet another way. By a linear transformation  $H$  is transformed into a tube domain  $T = \mathbb{R}^n(x) + iC^+$  over a cone  $C^+ \subset \mathbb{R}^n(y)$  (see subsection 2), and without loss of generality we may assume that  $C^+$  belongs to the positive orthant  $\{y_1 > 0, \dots, y_n > 0\}$ .

Let  $f = (f_1, \dots, f_n)$ ; we fix a point  $x^0 + iy^0 \in T$  and write  $g_k(\zeta) = f_k(x^0 + \zeta y^0)$ , where  $\zeta = \xi + i\eta \in \mathbb{C}$ . For any  $\eta > 0$  the point  $z = x^0 + \xi y^0 + i\eta y^0 \in T$  and  $\text{Im } g_k(\zeta) > 0$ , and since  $f$  maps the skeleton of the domain  $T$  (i.e.,  $\mathbb{R}^n(x)$ ) into itself, then  $\text{Im } g_k(\zeta) = 0$  for  $\eta = 0$ . Thus, for any  $k = 1, \dots, n$  the function  $g_k(\zeta)$  satisfies the hypotheses of Chebotarev's lemma (see Problem 12 to Chapter IV of Part I), and hence is linear. From this we also get the linearity of  $f$ .

**11. Fatou's example.** In Part I it was proved that any holomorphic automorphism of the complex plane  $\mathbb{C}$ , as well as of the disc  $\{|z| < R\}$  of arbitrary radius  $R$ , is linear-fractional (more precisely, is even linear). From the results of the preceding subsection it follows immediately that for  $n > 1$  automorphisms of balls  $\{|z| < R\}$  and polydiscs  $\{\|z\| < R\}$  of arbitrary radius are also linear-fractional.

However, for  $n > 1$ , in contrast to the case of the plane, passage to the limit as  $R \rightarrow \infty$  is not possible: it is easy to see that in  $\mathbb{C}^n$  for  $n > 1$  there exist **NONLINEAR** automorphisms. For example, an arbitrary mapping

$$f: (z_1, z_2) \rightarrow (z_1 + \varphi(z_2), z_2), \quad (1)$$

where  $\varphi$  is an arbitrary entire function of one variable, will be a holomorphic automorphism in  $\mathbb{C}^2$ . In fact, it is holomorphic in  $\mathbb{C}^2$  and its inverse  $f^{-1}: (w_1, w_2) \rightarrow (w_1 - \varphi(w_2), w_2)$  is also holomorphic in  $\mathbb{C}^2$ .

We remark that for the compactified spaces  $\overline{\mathbb{C}}^n$  and  $\mathbb{P}^n$  holomorphic automorphisms are again linear-fractional.

Furthermore, any biholomorphic mapping of  $\mathbb{C}$  into itself is surjective, i.e., is a mapping onto  $\mathbb{C}$  (and hence is linear). For  $n > 1$  this assertion also becomes false, as is seen from an example constructed in 1922 by P. FATOU. We propose a simplified variant of this example.

We consider two automorphisms of  $\mathbb{C}^2$ , a linear one

$$A: (z_1, z_2) \rightarrow (-az_1, az_2), \quad 0 < a < 1, \quad (2)$$

and a nonlinear one

$$\eta: (z_1, z_2) \rightarrow (z_2, a^2 z_1 + (1 - a^2) z_2^2). \quad (3)$$

The automorphism  $\eta$  has two fixed points  $(0, 0)$  and  $(1, 1)$ . At the first

of these

$$\eta'(0) = \begin{pmatrix} 0 & 1 \\ a^2 & 0 \end{pmatrix}$$

is a matrix with eigenvalues  $\lambda = \pm a$ , less than 1 in modulus, so that this point is attracting for the family of iterations  $\eta^\nu = \eta \circ \eta^{\nu-1}$  ( $\eta^1 = \eta$ ;  $\nu = 2, 3, \dots$ ).<sup>(25)</sup>

We now consider the functional equation

$$\eta \circ f = f \circ A, \quad (4)$$

which, if we set  $f = (f_1, f_2)$ , can be rewritten in the form

$$f_2(z) = f_1(Az), \quad a^2 f_1(z) + (1 - a^2) f_2^2(z) = f_2(Az), \quad (5)$$

and hence, reduces to an equation for the function  $f_1$ :

$$a^2 f_1(z) + (1 - a^2) f_1^2(Az) = f_1(A^2 z) \quad (6)$$

(we have substituted the expression for  $f_2$  from the first equation of (5) in the second equation).

We shall prove that the equation (6) has a holomorphic solution at the origin which is of the form

$$f_1(z) = z_1 + z_2 + \sum_{|k| \geq 2} b_k z^k = z_1 + z_2 + \varphi(z), \quad k = (k_1, k_2). \quad (7)$$

For this we remark that the function  $\varphi$  satisfies the equation

$$a^2 \varphi(z) - \varphi(A^2 z) = (a^2 - 1)(a(z_2 - z_1) + \varphi(Az))^2, \quad (8)$$

and to study this we use the following method. We shall write  $\sum a_k z^k \ll \sum b_k z^k$  if  $|a_k| \leq |b_k|$  for all  $k$ , and we denote  $\|\sum a_k z^k\| = \sum |a_k| |z^k|$ . Since  $A^2 z = (a^2 z_1, a^2 z_2)$ , we have  $a^2 \varphi(z) - \varphi(A^2 z) = \sum_{|k| \geq 2} b_k (a^2 - a^{2|k|}) z^k$ , and hence

$$\|a^2 \varphi(z) - \varphi(A^2 z)\| \gg a^2 (1 - a^2) \|\varphi(z)\|.$$

On the other hand,

$$\|(a(z_2 - z_1) + \varphi(Az))^2\| \ll a^2 (z_1 + z_2 + a \|\varphi(z)\|)^2,$$

so that from (8) we will obtain

$$\|\varphi(z)\| \ll (z_1 + z_2 + a \|\varphi(z)\|)^2. \quad (9)$$

We now consider instead of (9) the corresponding equation

$$\Phi(t) = (t + a\Phi(t))^2;$$

it has the solution  $\Phi(t) = \frac{1}{2a^2} (1 - 2at - \sqrt{1 - 4at}) = \sum_{\mu \geq 2} c_\mu t^\mu$ , where  $c_\mu > 0$  and the series converges in a neighborhood of  $t = 0$ . It is not hard to see

<sup>(25)</sup>At the second fixed point  $(1, 1)$  one of the eigenvalues is less than 1 in modulus, and the other is greater than 1.

that  $\varphi(z) \ll \Phi(z_1 + z_2)$ ,<sup>(26)</sup> so that the series for  $\varphi$ , and hence also for  $f_1$ , converges in a neighborhood of  $z = 0$ . Thus, equation (4) has a solution  $f$  that is holomorphic at the origin.

We turn to a description of the example. From equation (4) it follows that  $f = \eta^{-1} \circ f \circ A$ , from which by iterations we will obtain

$$f = \eta^{-1} \circ (\eta^{-1} \circ f \circ A) \circ A = \eta^{-2} \circ f \circ A^2$$

and more generally

$$f(z) = \eta^{-\nu} \circ f \circ A^\nu(z), \quad \nu = 1, 2, \dots \quad (10)$$

Since  $A$  is contractible it follows from this relation that  $f$  extends to a holomorphic mapping  $\mathbb{C}^2 \rightarrow \mathbb{C}^2$  (in fact, for any  $z \in \mathbb{C}^2$  for sufficiently large  $\nu$  the point  $A^\nu(z)$  lands in a neighborhood of 0, where  $f$  is defined and is holomorphic, so that the right-hand side of (10), and hence the left-hand side, is defined and holomorphic in all of  $\mathbb{C}^2$ ). This extended mapping is again denoted by  $f$ .

Furthermore, since the Jacobians  $J_\eta(z) = J_A(z) = -a^2$ , and by the chain rule it follows from (4) that  $J_\eta(f) \cdot J_f(z) = J_f(Az) \cdot J_A(z)$ , then for all  $z \in \mathbb{C}^2$  we have  $J_f(z) = J_f(Az)$ . By iteration we will obtain from this that  $J_f(z) = J_f(A^\nu z)$  for  $\nu = 1, 2, \dots$ , and since  $A^\nu z \rightarrow 0$ , then since  $J_f$  is continuous we conclude that  $J_f(z) = J_f(0)$  for all  $z \in \mathbb{C}^2$ . Since  $f_1(z) = z_1 + z_2 + \dots$ ,  $f_2(z) = f_1(Az) = -az_1 + az_2 + \dots$  in a neighborhood of the origin, we have  $J_f(0) = 2a \neq 0$ , and hence the mapping  $f$  is locally biholomorphic. From relation (10) we conclude that it is also globally biholomorphic.

We shall show that the image of  $\mathbb{C}^2$  under this mapping coincides with the domain of attraction of the fixed point  $(0, 0)$  of the automorphism  $\eta$ :

$$G = f(\mathbb{C}^2) = \left\{ z \in \mathbb{C}^2 : \lim_{\nu \rightarrow \infty} \eta^\nu(z) = 0 \right\}. \quad (11)$$

In fact, if  $z \in G$ , then there is a point  $z' \in \mathbb{C}^2$  such that  $z = f(z')$ , and then from (10) we will conclude that  $\eta^\nu(z) = \eta^\nu \circ f(z') = f(A^\nu z') \rightarrow f(0) = 0$  as  $\nu \rightarrow \infty$ . Conversely, if  $\eta^\nu(z) \rightarrow 0$ , then in view of the fact that the values of  $f$  cover some neighborhood of the origin, for sufficiently large  $\nu$  there is a point  $z' \in \mathbb{C}^2$  such that  $\eta^\nu(z) = f(z')$ , and then, by (10),  $z = \eta^{-\nu} \circ f(z') = f(A^{-\nu} z')$ , i.e.,  $z \in G$ .

For a more detailed description<sup>(27)</sup> of the domain  $G$  it is convenient to write  $\varphi_0(z) = z_1$  and  $\varphi_1(z) = z_2$ , and then successively to set

$$\varphi_{\nu+1}(z) = a^2 \varphi_{\nu-1}(z) + (1 - a^2) \varphi_\nu^2(z), \quad \nu = 1, 2, \dots \quad (12)$$

<sup>(26)</sup>For the proof we can use induction on  $|k| = \mu$ , remarking that (9) estimates the coefficient of the expansion  $\|\varphi(z)\| = \sum_{|k| \geq 2} |b_k| z^k$  with given  $|k|$  by means of a coefficient with smaller  $|k|$ .

<sup>(27)</sup>This description is due to E. Udovičić.

Then, using (3), we obtain that  $\eta^\nu(z) = (\varphi_\nu(z), \varphi_{\nu+1}(z))$ , and hence, the image  $f(\mathbb{C}^2)$  is described as the set

$$G = \left\{ z \in \mathbb{C}^2 : \lim_{\nu \rightarrow \infty} \varphi_\nu(z) = 0 \right\}. \quad (13)$$

We remark that if  $|\varphi_{\nu-1}(z)| \leq r$  and  $|\varphi_\nu(z)| \leq r$  at  $z \in \mathbb{C}^2$  for some two successive members, where  $r < 1$ , then by (12) we also have  $|\varphi_{\nu+1}(z)| \leq a^2r + (1 - a^2)r = r$  at this point. Then we also have  $|\varphi_\mu(z)| \leq r$  at this point for all later indices  $\mu$ , and hence,  $\overline{\lim}_{\nu \rightarrow \infty} |\varphi_\nu(z)| = l \leq r$ . Choosing a subsequence of indices for which  $|\varphi_{\nu_j+1}(z)| \rightarrow l$ , we obtain from (12) that  $l \leq l(a^2 + (1 - a^2)l)$ . If  $l \neq 0$ , then we obtain from the last inequality that  $a^2 + (1 - a^2)l \geq 1$ , whence  $l \geq 1$ , and this contradicts the fact that  $l \leq r$ . Thus,  $l = 0$ , and hence  $\lim_{\nu \rightarrow \infty} \varphi_\nu(z) = 0$ , i.e.,  $z \in G$ .

It follows from this remark that the set  $D_1 = \{|z_1| < 1, |z_2| \leq 1\} \subset G$ , since for any point  $z \in D_1$  we have  $|\varphi_2(z)| < a^2 + (1 - a^2) = 1$ , and analogously  $|\varphi_3(z)| < 1$ . In exactly the same way  $D_2 = \{a^2|z_1| + (1 - a^2)|z_2|^2 \leq 1, |z_2| < 1\} \subset G$ , since  $|\varphi_3(z)| < 1$  and  $|\varphi_4(z)| < 1$  for the points of this set. The point  $(1, 1)$  is a fixed point of the automorphism  $\eta$ , and from (11) we see that it does not belong to  $G$ ; from the preceding discussion it is clear that  $(1, 1)$  is a boundary point of  $G$ .<sup>(28)</sup>

A very interesting peculiarity of this example is that the domain  $G$  is far from filling up the whole space  $\mathbb{C}^2$ . To see this, we let  $b_t = (t + a^2)/t(1 - a^2)$ , and for  $0 < t \leq 1$  we consider the set

$$E_t = \left\{ z \in \mathbb{C}^2 : \left| \frac{z_2}{z_1} \right| \geq t, |z_2| \geq b_t \right\}. \quad (14)$$

It is not difficult to see that if  $z \in E_t$ , then  $\eta(z) \in E_t$  as well (in fact, by (3) the coordinates of the point  $\eta(z)$  are equal to  $\eta_1(z) = z_2$  and  $\eta_2(z) = a^2z_1 + (1 - a^2)z_2^2$ , so that from (14) we will obtain  $|\eta_2(z)/\eta_1(z)| \geq (1 - a^2)|z_2| - a^2|z_1/z_2| \geq (t + a^2)/t - a^2/t = 1 \geq t$  and furthermore  $|\eta_2(z)| \geq |\eta_1(z)| = |z_2| \geq b_t$ ). From this it follows that for points  $z \in E_t$  the quantity  $\eta^\nu(z)$  cannot tend to 0 as  $\nu \rightarrow \infty$ , and hence  $E_t \subset \mathbb{C}^2 \setminus G$  for any  $t \in (0, 1]$ . But then  $\mathbb{C}^2 \setminus G$  also contains the set  $E = \bigcup_{t \in (0, 1]} E_t$ , whose image on the Reinhardt diagram is bounded by the segment  $\{0 < |z_1| \leq b, |z_2| = b\}$  and the piece of a parabola given by  $\{a^2|z_1| = (1 - a^2)|z_2|^2 - |z_2|, |z_1| \geq b\}$ , where  $b = b_1 = (1 + a^2)(1 - a^2) > 1$ .

The results of this investigation are shown in Figure 12 on the next page, where the slanted lines indicate the part that certainly belongs to  $G$  and the vertical lines indicate the part that certainly does not belong to  $G$ . We remark

<sup>(28)</sup>One can show that on the torus  $T = \{|z_1| = 1, |z_2| = 1\}$  there are two more boundary points of  $G$ : the points  $(e^{2\pi i/3}, e^{-2\pi i/3})$  and  $(e^{-2\pi i/3}, e^{2\pi i/3})$ , which are transposed by the automorphism  $\eta$ ; the remaining points of  $T$  belong to  $G$ .

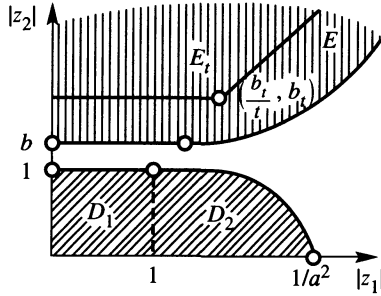

FIGURE 12

that the smaller the value of the parameter  $a$ , the sharper our estimate (as  $a \rightarrow 0$  the domain  $D_1 \cup D_2$  tends to the half-strip  $\{|z_1| \geq 0, |z_2| < 1\}$ , and  $E$  tends to the complement of this).

Thus, we have constructed an example of a nondegenerate holomorphic (and even biholomorphic) mapping  $f: \mathbb{C}^2 \rightarrow \mathbb{C}^2$  for which the set  $\mathbb{C}^2 \setminus f(\mathbb{C}^2)$  of values that are not attained contains a nonempty open set.

This example shows that for  $n > 1$  it is not possible to extend in a direct form to holomorphic mappings of  $\mathbb{C}^n$  either the theorem of Picard or even the theorem of Sokhotskiĭ.\* We will discuss forms in which these theorems do generalize to the higher-dimensional case in the last chapter.

### Problems

1. (a) Let  $l_1$  and  $l_2$  be two complex lines in  $\mathbb{C}^2$  that are not orthogonal to each other. Prove that the orthogonal projection of a circle  $\gamma \subset l_1$  is a circle on  $l_2$ .

(b) Let  $l_1$  be a real two-dimensional plane in  $\mathbb{C}^2$  and  $l_2$  a complex line. Prove that if the projection of any circle  $\gamma \subset l_1$  is again a circle on  $l_2$ , then  $l_1$  is either a complex or an anticomplex line.

2. Prove that two distinct complex lines in  $\mathbb{C}^2$  can have at most one common point.

3. Prove that in  $\mathbb{P}^n$  two arbitrary (complex) hyperplanes intersect.

4. Prove that the Reinhardt transformation  $\alpha(z) = (|z_1|, \dots, |z_n|)$  maps any domain  $D \subset \mathbb{C}^n$  that does not intersect the set  $\{z_1 \cdots z_n = 0\}$  into a domain of  $\mathbb{R}^n$ .

5. Prove that a complete Hartogs domain  $D \subset \mathbb{C}^n$  is convex if and only if its image  $\beta(D)$  under the transformation  $\beta(z) = (|z, |z_n|)$  is a convex domain in  $\mathbb{R}^{2n-1}$ .

6. (L. A. AIZENBERG) The Bergman boundary of a domain  $D$  is the minimal closed set  $B \subset \partial D$  such that  $\sup_{z \in B} |f(z)| = \sup_{z \in D} |f(z)|$  for all functions holomorphic in  $\bar{D}$ . It is obvious that  $B$  is contained in the Shilov boundary  $S$  of  $D$ . Prove that these boundaries are distinct for the domain  $D = \{0 < |z_1| < 1, |z_2| < |z_1|^{-\ln|z_1|}\} \subset \mathbb{C}^2$ : namely,  $S = \{|z_1| \leq 1, |z_2| = |z_1|^{-\ln|z_1|}\}$  and  $B = \{|z_1| = 1, |z_2| = 1\}$ .

7. A set  $M$  is called a set of uniqueness for functions of a class  $\mathcal{F}$  if any function  $f \in \mathcal{F}$ , equal to 0 on  $M$ , is identically equal to 0. Prove that the following sets are sets of uniqueness for functions belonging to  $\mathcal{O}(\mathbb{C}^2)$ :

(a) a real hyperplane in  $\mathbb{C}^2$ ,

(b) the real two-dimensional plane  $\{z_1 = \bar{z}_2\}$ ,

(c) the arc  $\{z_2 = \bar{z}_1, y_1 = x_1 \sin(1/x_1)\}$ .

(\* Editor's note. Same as the Casorati-Weierstrass theorem.

8. Give an example of a sequence of points that converges to the center of the polydisc  $U^n$  and is a set of uniqueness for functions of the class  $\mathcal{O}(U^n)$ .

9. Prove that any nonempty open subset of the skeleton of the polydisc  $U^n$  is a set of uniqueness for functions of the class  $\mathcal{O}(U^n) \cap C(\bar{U}^n)$ .

10. Prove that if, for each fixed  $(z_1^0, \dots, z_{\nu-1}^0, z_{\nu+1}^0, \dots, z_n^0)$ ,  $\nu = 1, \dots, n$ , the function  $f(z_1, \dots, z_n)$

(a) is a polynomial relative to  $z_\nu$ , then it is a polynomial;

(b) is a rational function of  $z_\nu$ , then it is a rational function.

11. Give an example of a function  $f(z_1, z_2)$ , holomorphic with respect to  $z_1$  in  $\{|z_1| < 1\}$  for any  $z_2$ ,  $|z_2| < 1$ , and continuous with respect to  $z_2$  in  $\{|z_2| < 1\}$  for any  $z_1$ ,  $|z_1| < 1$ , and which is not continuous with respect to  $z = (z_1, z_2)$  in the bidisc  $\{|z_1| < 1, |z_2| < 1\}$ .

12. Let  $U^n$  be a polydisc and  $\Gamma$  its skeleton; prove that if we have  $|f| = \text{const}$  on  $\Gamma$  for a function  $f \in \mathcal{O}(U^n) \cap C(\bar{U}^n)$ , then  $f$  is a rational function.

13. Construct power series whose domains of convergence are: (a) the ball  $\{z \in \mathbb{C}^2 : |z_1|^2 + |z_2|^2 < 1\}$ ; (b) the domain  $\{z \in \mathbb{C}^2 : |z_1| + |z_2| < 1\}$ .

14. Prove that any convex Reinhardt domain is logarithmically convex.

15. Prove that under the hypotheses of the Schwarz lemma (Theorem 6 of subsection 9) the inequality (9) can be sharpened in the following way:  $\|f(z)\|_2 \leq \|z\|_1^m$ , where  $m \geq 1$  is the smallest of the degrees of the lowest nonzero polynomials in the expansion of  $f_\nu$  in a series in homogeneous polynomials.

16. Let  $f$  be a holomorphic mapping of the unit ball  $B \subset \mathbb{C}^n$  into  $\mathbb{C}^n$  such that  $f(0) = 0$ . Prove that for any number  $p \geq 1$  we have the following generalization of the Schwarz inequality:  $\sum_\nu |f_\nu(z)|^p \leq |z|^p \sup_B \sum_\nu |f_\nu|^p$ ,  $z \in B$ .

17. Give a counterexample to the assertion that occurs in the problems in the preceding edition of this book: if in the Schwarz lemma  $\|\cdot\|_1$  and  $\|\cdot\|_2$  are norms with strictly convex balls, then the equality  $\|f(z)\|_2 = \|z\|_1$  is attained on a complex subspace  $L \subset B_1$ .

18. Prove that the ball  $B^n = \{z \in \mathbb{C}^n : |z| < 1\}$  is biholomorphically equivalent to the domain  $D = \{y_n > |z|^2\}$ . [HINT: consider the mapping  $z \rightarrow z/(1+z_n)$ ,  $z_n \rightarrow i(1-z_n)/(1+z_n)$ .] We remark that the surface  $\{z \in \mathbb{C}^2 : y_2 = |z_1|^2\}$  was first considered by POINCARÉ.

19. (V. V. RABOTIN) Denote by  $\mathcal{O}(\mathbb{C}^n, \mathbb{C}^m)$  the space of all holomorphic mappings  $f: \mathbb{C}^n \rightarrow \mathbb{C}^m$  with the topology of uniform convergence on compact subsets (a sequence of points  $f^\mu \in \mathcal{O}(\mathbb{C}^n, \mathbb{C}^m)$  is said to converge to the point  $f$  if  $f^\mu \rightarrow f$  uniformly on any  $K \subset \subset \mathbb{C}^n$ ). Let  $Q$  be the set of quas surjective mappings  $f \in \mathcal{O}(\mathbb{C}^n, \mathbb{C}^n)$ , i.e., mappings such that  $f(\mathbb{C}^n)$  is dense in  $\mathbb{C}^n$ , and let  $F$  be its complement (in particular,  $F$  contains the mappings of Fatou type, i.e., homeomorphisms for which  $f(\mathbb{C}^n)$  is not dense in  $\mathbb{C}^n$ ). Prove that:

(a) the set  $F$  is dense in  $\mathcal{O}(\mathbb{C}^n, \mathbb{C}^n)$  and, in particular, in any neighborhood of an arbitrary point  $f \in \mathcal{O}(\mathbb{C}^n, \mathbb{C}^n)$  there is a mapping of Fatou type;

(b) the sets  $F$  and  $Q$  are arcwise connected.

20. Give an example of a holomorphic curve  $f: \mathbb{C} \rightarrow \mathbb{C}^n$  for which the set of limit values over all possible sequences  $\zeta^\mu \in \mathbb{C}$  that converge to infinity coincides with all of  $\mathbb{C}^n$ . [HINT: use Problem 9 to Chapter V of Part I.]

21. Prove that the set of holomorphic mappings  $\mathbb{C} \rightarrow \mathbb{C}^n$  possessing the property indicated in Problem 20 is everywhere dense in the space  $\mathcal{O}(\mathbb{C}, \mathbb{C}^n)$ .





## CHAPTER II

### Basic Geometric Concepts

In this chapter we introduce the basic geometric objects of higher-dimensional complex analysis. Part of it (§7 and particularly §9) contains auxiliary material from other parts of mathematics that are needed for the later development of the theory. This material can be omitted with the idea that one can turn to it if necessary in the course of later reading.

#### §5. Manifolds and Stokes's formula

**12. The concept of a manifold.** We assume that the reader is familiar with this concept<sup>(1)</sup> and restrict ourselves to recalling notions and to describing peculiarities of the complex structure.

Suppose we are given a connected Hausdorff space  $M$  with a countable base of open sets. We assume that  $M$  admits a covering  $\mathcal{U} = \{U_\alpha\}_{\alpha \in A}$  ( $A$  is an arbitrary set of indices) by domains  $U_\alpha \subset M$  that are homeomorphic to balls  $B_\alpha$  of the Euclidean space  $\mathbb{R}^n$ . The pair  $(U_\alpha, \varphi_\alpha)$ , where  $\varphi_\alpha: U_\alpha \rightarrow B_\alpha$  is a homeomorphism, is called a *chart*, and the set of charts  $\mathcal{A} = \{(U_\alpha, \varphi_\alpha)\}_{\alpha \in A}$  is called the *atlas* of the covering  $\mathcal{U}$ . The neighborhoods  $U_\alpha$  are called *coordinate neighborhoods*, and the vector variables  $x^\alpha = (x_1^\alpha, \dots, x_n^\alpha) = \varphi_\alpha(p)$ , where  $p \in U_\alpha$ , are called *local coordinates* acting in  $U_\alpha$ .

If  $U_{\alpha\beta} = U_\alpha \cap U_\beta \neq \emptyset$ , then there is a homeomorphism

$$\varphi_{\alpha\beta} = \varphi_\beta \circ \varphi_\alpha^{-1}: \varphi_\alpha(U_{\alpha\beta}) \rightarrow B_\beta \quad (1)$$

(see Figure 13 on the next page); such homeomorphisms are called *compatibility relations* of the atlas  $\mathcal{A}$ . Since compatibility relations are mappings of open sets of  $\mathbb{R}^n$ , we can talk about their smoothness. If all the compatibility relations of an atlas  $\mathcal{A}$  are mappings of class  $C^k$ , then we say that  $\mathcal{A}$  is an *atlas of smoothness  $k$* . For  $k \geq 1$  all the  $\varphi_{\alpha\beta}$  are diffeomorphisms, and hence  $\det \varphi'_{\alpha\beta} \neq 0$ .<sup>(2)</sup>

<sup>(1)</sup>See for example, M. Spivak, *Calculus on manifolds. A modern approach to classical theorems of advanced calculus*, Benjamin, New York and Amsterdam, 1965.

<sup>(2)</sup>We note that  $(\varphi_{\alpha\beta})^{-1} = \varphi_{\beta\alpha}$ , so that for an atlas of class  $C^k$  along with  $\varphi_{\alpha\beta}$   $(\varphi_{\alpha\beta})^{-1}$  also belongs to this class.

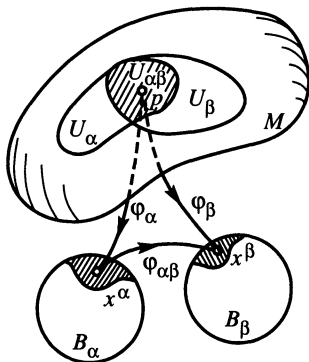

FIGURE 13

In order to arrive at the concept of a manifold, it remains to make one last step, the step of eliminating the dependence on the choice of a concrete atlas. To do this we will say that two atlases  $\mathcal{A} = \{(U_\alpha, \varphi_\alpha)\}_{\alpha \in A}$  and  $\mathcal{A}' = \{(U'_\beta, \varphi'_\beta)\}_{\beta \in B}$  of smoothness  $k$  corresponding to the coverings  $\{U_\alpha\}_{\alpha \in A}$  and  $\{U'_\beta\}_{\beta \in B}$  of the space  $M$  are *equivalent* if their union  $\mathcal{A} \cup \mathcal{A}' = \{(U_\alpha, \varphi_\alpha), (U'_\beta, \varphi'_\beta)\}_{\alpha \in A, \beta \in B}$  is also an atlas of smoothness  $k$ . The meaning of this requirement is that the compatibility relations in passing from charts of one atlas to the charts of another have the same smoothness as the compatibility relations of each atlas separately. A *manifold of smoothness  $k$*  is a space  $M$  together with an equivalence class of atlases of smoothness  $k$  defined on it; for  $k = 0$  a manifold is said to be *topological*. The dimension of the balls to which the domains of the covering  $\mathcal{U}$  are homeomorphic is called the (real) *dimension of the manifold* ( $n = \dim_{\mathbb{R}} M$ ).

On a manifold  $M$  of smoothness  $k$  we can speak about functions of class  $C^l$ ,  $l \leq k$ ; these are functions  $f: M \rightarrow \mathbb{R}$  such that in any local coordinate  $x^\alpha = \varphi_\alpha(p)$  the composition  $f \circ \varphi_\alpha^{-1}$  is a function of class  $C^l$  on the open set  $\varphi_\alpha(U_\alpha) \subset \mathbb{R}^n$ . It is obvious that this notion is well defined, i.e., does not depend on the choice of atlas from the equivalence class under consideration or on the choice of chart in this atlas.

The concept of a complex manifold is defined according to the same scheme. Suppose the space  $M$  (with the same assumptions) is covered by domains  $U_\alpha$  that are homeomorphic to  $2n$ -dimensional balls, and  $\varphi_\alpha: U_\alpha \rightarrow \mathbb{C}^n$  are these homeomorphisms ( $z^\alpha = \varphi_\alpha(p)$  are called local coordinates). We say that an atlas  $\mathcal{A} = \{(U_\alpha, \varphi_\alpha)\}_{\alpha \in A}$  is *complex* if all the compatibility relations  $\varphi_{\alpha\beta} = \varphi_\beta \circ \varphi_\alpha^{-1}$  ( $\alpha, \beta \in A$ ) are BIHOLOMORPHIC mappings of the corresponding open sets in  $\mathbb{C}^n$ . Two such atlases are said to be equivalent if their union is also a complex atlas. The space  $M$  together with the equivalence class with respect to this relation is called a *complex manifold*. The number  $n = \dim_{\mathbb{C}} M$  is called the (complex) dimension of the manifold. We give some examples of complex manifolds.

1. Trivial examples of  $n$ -dimensional complex manifolds are the space  $\mathbb{C}^n$  and domains in it. For  $\mathbb{C}^n$  we can take an atlas consisting of one chart:  $\mathbb{C}^n$  itself with the identity mapping  $\varphi$ . A domain  $D \subset \mathbb{C}^n$  can be covered by a family of balls  $B_\alpha = \{|z - a| < \delta(a, \partial D)\}$ ,  $a \in D$  (here  $\delta(a, \partial D)$  is the Euclidean distance of  $a$  from  $\partial D$ ); all the mappings  $\varphi_\alpha$  and the compatibility relations are identity mappings.

2. COMPLEX PROJECTIVE SPACE  $\mathbb{P}^n$  admits a finite covering by domains  $U_j = \{[w_0, \dots, w_n] \in \mathbb{P}^n : w_j \neq 0\}$ ,  $j = 0, \dots, n$  (it is clear that the condition  $w_j \neq 0$  does not depend on the choice of representative of the class  $[w]$ ). As a local coordinate in  $U_j$  we take

$$\varphi_j([w]) = \left( \frac{w_0}{w_j}, \dots, \frac{w_{j-1}}{w_j}, \frac{w_{j+1}}{w_j}, \dots, \frac{w_n}{w_j} \right) : U_j \rightarrow \mathbb{C}^n;$$

obviously  $\varphi_j(U_j) = \mathbb{C}^n$ . It is not hard to see that the atlas  $\{(U_j, \varphi_j)\}_{j=0}^n$  is complex, i.e., that all its compatibility relations are biholomorphic.<sup>(3)</sup> The atlases equivalent to this one define  $\mathbb{P}^n$  as a complex manifold of dimension  $n$ .

In particular, the space  $\mathbb{P}^1 = \overline{\mathbb{C}}$  is covered by the two neighborhoods  $U_0 = \{[w_0, w_1] : w_0 \neq 0\}$  and  $U_1 = \{[w_0, w_1] : w_1 \neq 0\}$ . In the first of these we have the local coordinate  $z = w_1/w_0$ , and in the second, the coordinate  $w_0/w_1 = 1/z$ .

3. THE SPACE  $\overline{\mathbb{C}}^n$  (see subsection 1) is also an  $n$ -dimensional complex manifold. To see this we cover the sphere  $\overline{\mathbb{C}}$  of the variable  $z_\nu$  by the two neighborhoods  $U_0^{(\nu)} = \mathbb{C}$  and  $U_1^{(\nu)} = \overline{\mathbb{C}} \setminus \{0\}$ , as in the preceding example. Then  $\overline{\mathbb{C}}^n$  is covered by the  $2^n$  neighborhoods  $U_j = U_{j_1}^{(1)} \times \dots \times U_{j_n}^{(n)}$ , where  $j = (j_1, \dots, j_n)$  is an arbitrary set of 0's and 1's. In each  $U_j$  we have the coordinate  $z^j = (z_1^{j_1}, \dots, z_n^{j_n})$ , where  $z_\nu^{j_\nu} = z_\nu$  if  $j_\nu = 0$  and  $z_\nu^{j_\nu} = 1/z_\nu$  if  $j_\nu = 1$ . The atlas  $\{(U_j, z^j)\}_{j=1}^{2^n}$  is obviously complex.

4. THE GRASSMANN MANIFOLD (OR GRASSMANNIAN)  $G(n, k)$ ,  $k < n$ , is defined as the set of  $k$ -dimensional projective subspaces of  $\mathbb{P}^n$  or, equivalently, the set of  $(k+1)$ -dimensional complex planes of  $\mathbb{C}^{n+1}$  that pass through the origin.<sup>(4)</sup> This is a generalization of projective spaces:  $G(n, 0) = \mathbb{P}^n$ .

For an analytic description of  $G(n, k)$  we fix a point  $\Pi$  of it, i.e., a  $(k+1)$ -dimensional subspace of  $\mathbb{C}^{n+1}$ , in it we choose  $k+1$  linearly independent

<sup>(3)</sup>As an example, we write the relation  $\varphi_{01}$ . We have  $U_{01} = \{[w] : w_0, w_1 \neq 0\}$ ,  $\varphi_0([w]) = (w_1/w_0, \dots, w_n/w_0) = z$ , and  $\varphi_0(U_{01}) = \mathbb{C}^n \setminus \{z_1 = 0\}$ . Further,  $\varphi_0^{-1}(z) = [1, z]$ ,  $\varphi_1([1, z]) = (1/z_1, z_2/z_1, \dots, z_n/z_1)$ , and hence  $\varphi_{01} = (z_1, \dots, z_n) \rightarrow (1/z_1, z_2/z_1, \dots, z_n/z_1)$ .

<sup>(4)</sup>The correspondence between these two sets is realized by the mapping  $\rho: \mathbb{C}^{n+1} \setminus \{0\} \rightarrow \mathbb{P}^n$ , which to each point associates the complex line passing through 0 and this point.

vectors  $a^\mu = (a_0^\mu, \dots, a_n^\mu)$ ,  $\mu = 0, \dots, k$ , and from them we form the matrix

$$A = \begin{pmatrix} a_0^0 & \cdots & a_n^0 \\ \vdots & & \vdots \\ a_0^k & \cdots & a_n^k \end{pmatrix}, \quad (2)$$

the rank of which is equal to  $k + 1$ . If in  $\Pi$  we choose another basis  $\{b^\nu\}$ , then it is expressed in terms of  $\{a^\mu\}$  according to the formulas  $b^\nu = \sum_{\mu=0}^k c_{\mu\nu} a^\mu$  ( $\nu = 0, \dots, k$ ), where  $C = (c_{\mu\nu})$  is a nondegenerate matrix, and then the corresponding matrix

$$B = \begin{pmatrix} b_0^0 & \cdots & b_n^0 \\ \vdots & & \vdots \\ b_0^k & \cdots & b_n^k \end{pmatrix} = AC. \quad (3)$$

Conversely, to any  $(n + 1) \times (k + 1)$  matrix  $A$  of rank  $k + 1$  ( $0 \leq k \leq n$ ) one can associate a  $(k + 1)$ -dimensional plane  $\Pi \subset \mathbb{C}^{n+1}$  that passes through 0, namely the plane spanned by the column vectors of this matrix (they are linearly independent). The same plane  $\Pi$  will also correspond to matrices  $B$  obtained from  $A$  by right multiplication by a nondegenerate  $(k + 1) \times (k + 1)$  matrix  $C$ . Thus, the Grassmann manifold  $G(n, k)$  can be interpreted as the set of  $(n + 1) \times (k + 1)$  matrices of rank  $k + 1$ , factored by the following equivalence relation:  $A \sim B$  if there exists a nondegenerate  $(k + 1) \times (k + 1)$  matrix  $C$  such that  $B = AC$ .

This interpretation allows us to introduce coordinates in  $G(n, k)$ . For a given point  $\Pi \in G(n, k)$  we choose a matrix (2) representing it, and for any set  $\nu = (\nu_0, \dots, \nu_k)$ ,  $0 \leq \nu_0 < \nu_1 < \dots < \nu_k \leq n$ , we let

$$p_\nu = \det \begin{pmatrix} a_{\nu_0}^0 & \cdots & a_{\nu_0}^k \\ \vdots & & \vdots \\ a_{\nu_k}^0 & \cdots & a_{\nu_k}^k \end{pmatrix}. \quad (4)$$

From the foregoing we see that not all the numbers  $p_\nu$  are equal to 0 and that they are defined up to a nonzero complex multiple (in replacing  $A$  by the matrix  $B = AC$  they are multiplied by  $\det C$ ). Conversely, giving the minors  $p_\nu$  of the matrix  $A$  determines a corresponding plane  $\Pi$ , since the condition of linear dependence of the vector  $z$  on  $\{a^\mu\}$  is that the rank of the matrix  $(a^0, \dots, a^k, z)$  is equal to  $k + 1$  and is expressed via these minors. It is also clear that the multiplication of all the minors by a nonzero complex factor does not change the plane  $\Pi$ .

Thus, the numbers (4) are generalized homogeneous coordinates; they are called *Plücker coordinates* of the manifold  $G(n, k)$ . The number of them is equal to the binomial coefficient of  $n + 1$  by  $k + 1$ , i.e.,

$$N = \binom{n+1}{k+1} = \frac{(n+1)n \cdots (n-k+1)}{1 \cdot 2 \cdots (k+1)}. \quad (5)$$

The complex manifold structure in  $G(n, k)$  is also introduced as in the case of projective space. The manifold is covered by the neighborhoods  $U_\nu = \{\Pi \in G(n, k) : p_\nu(\Pi) \neq 0\}$ ; we consider one of them as an example, say  $U_{0\dots k}$ . The points of this neighborhood can be represented as matrices

$$\begin{pmatrix} a_0^0 & \cdots & a_0^k \\ \vdots & & \vdots \\ a_k^0 & \cdots & a_k^k \\ \vdots & & \vdots \\ a_n^0 & \cdots & a_n^k \end{pmatrix} \begin{pmatrix} a_0^0 & \cdots & a_0^k \\ \vdots & & \vdots \\ a_k^0 & \cdots & a_k^k \end{pmatrix}^{-1} = \begin{pmatrix} E \\ Z \end{pmatrix},$$

where  $E$  is the  $(k+1) \times (k+1)$  identity matrix and  $Z = (z_{\alpha\beta})$  is an arbitrary  $(n-k) \times (k+1)$  matrix. This representation is unique and the numbers  $z_{\alpha\beta}$  can be considered as local coordinates in the neighborhood  $U_{0\dots k}$ . These numbers are arbitrary, so that the complex dimension of  $U_{0\dots k}$  is

$$m = (n-k)(k+1). \quad (6)$$

In an analogous way we introduce local coordinates in the other domains of the covering, and the compatibility relations are biholomorphic, so that  $\dim G(n, k) = m$ .

The Plücker coordinates are determined by the point  $\Pi \in G(n, k)$  up to a scalar multiple, and the number of them is equal to  $N$ . If we consider them as homogeneous coordinates in a projective space  $\mathbb{P}^{N-1}$ , then they define an embedding  $p: G(n, k) \rightarrow \mathbb{P}^{N-1}$ . Since in the general case  $N-1 > m$ ,<sup>(5)</sup> then the Plücker coordinates are not all independent—there are relations between them which give the image of  $G(n, k)$  under the embedding  $p$  as a complex  $m$ -dimensional surface in  $\mathbb{P}^{N-1}$ .

EXAMPLE. The Grassmannian  $G(3, 1)$  can be interpreted as the set of complex lines in  $\mathbb{P}^3$ . If we specify a line by two of its points with homogeneous coordinates  $[z]$  and  $[w]$ , then the Plücker coordinates will be

$$p_{\mu\nu} = z_\mu w_\nu - z_\nu w_\mu, \quad \mu < \nu; \mu, \nu = 0, 1, 2, 3. \quad (7)$$

There are six of them, so that  $p: G(3, 1) \rightarrow \mathbb{P}^5$ , but by (6)  $\dim G(3, 1) = 4$ , so that there must be one relation between the  $p_{\mu\nu}$ . It is immediate to check that

$$p_{01}p_{23} - p_{02}p_{13} + p_{03}p_{12} = 0. \quad (8)$$

Thus,  $G(3, 1)$  can also be represented as a surface of order two in  $\mathbb{P}^5$ , described in homogeneous coordinates by the equations (8). This surface is called the *Klein quadric*.

\* Prove that the Klein quadric can be transformed into the surface  $z_0^2 + \cdots + z_5^2 = 0$  in  $\mathbb{C}^6$  by a unitary transformation of  $\mathbb{C}^6$  of the coordinates  $(p_{01}, \dots, p_{23})$ . \*

<sup>(5)</sup>For  $k = n-1$  we have  $N-1 = m$ , and as  $n$  grows for fixed  $k$  the quantity  $N$  grows faster than  $m$ .

Let  $M$  and  $N$  be two complex manifolds; a mapping  $f: M \rightarrow N$  is said to be *holomorphic* if for any point  $p \in M$  the mapping  $\psi \circ f \circ \varphi^{-1}$  is holomorphic, where  $\varphi$  and  $\psi$  are local homeomorphisms, acting respectively in neighborhoods of the points  $p$  and  $q = f(p)$ . This notion is obviously well defined, i.e., it does not depend on the choice of local coordinates. The set of all holomorphic mappings of a complex manifold  $M$  into a complex manifold  $N$  will be denoted by  $\mathcal{O}(M, N)$ , and  $\mathcal{O}(M)$  as before will be the set of holomorphic functions on  $M$ .

In particular, we define holomorphic functions on the manifolds  $\mathbb{P}^n$  and  $\overline{\mathbb{C}}^n$  as functions that depend holomorphically on the local coordinates acting in neighborhoods of their coverings. For example,  $f$  is holomorphic at the point  $(a_1, \infty) \in \overline{\mathbb{C}}^2$ ,  $a_1 \neq 0$ , if the function  $g(z_1, z_2) = f(z_1, 1/z_2)$  is holomorphic at the point  $(a_1, 0)$ . Since  $g$  is represented by the Taylor series

$$g(z_1, z_2) = \sum_{k_1, k_2=0}^{\infty} c_{k_1, k_2} (z_1 - a_1)^{k_1} z_2^{k_2},$$

which converges in some bidisc  $\{|z_1 - a_1| < r_1, |z_2| < r_2\}$ , then  $f$  is represented by the Laurent series

$$f(z_1, z_2) = \sum_{k_1, k_2=0}^{\infty} c_{k_1, k_2} \frac{(z_1 - a_1)^{k_1}}{z_2^{k_2}},$$

which converges in the neighborhood  $\{|z_1 - a_1| < r_1, |z_2| > 1/r_2\}$  of the point  $(a_1, \infty)$ .

We note two simple properties of holomorphic functions on complex manifolds.

**THEOREM 1 (uniqueness).** *If  $M$  is a complex manifold and the functions  $f, g \in \mathcal{O}(M)$  coincide on a nonempty open (in the topology of  $M$ ) subset of  $M$ , then they coincide everywhere on  $M$ .*

◀ We denote by  $E$  the interior of the set of all points  $p \in M$  at which  $f(p) = g(p)$ ; by hypothesis it is not empty. We shall show that  $E$  is also a closed set. In fact, suppose that  $p_0 \in M$  is a limit point of  $E$ . In a neighborhood  $U \subset M$  of  $p_0$  we have the local parameter  $\zeta = \varphi(p)$ , and the functions  $f \circ \varphi^{-1}$  and  $g \circ \varphi^{-1}$  are holomorphic at the point  $\zeta^0 = \varphi(p_0)$  of the ball  $B \subset \mathbb{C}^n$ . In any neighborhood  $V \subset B$  of the point  $\zeta^0$  there is a point  $\zeta^1$  such that  $p_1 = \varphi^{-1}(\zeta^1) \in E$ , and since  $f \equiv g$  in some neighborhood of  $p_1$ , then  $f \circ \varphi^{-1} \equiv g \circ \varphi^{-1}$  in some neighborhood of  $\zeta^1$ . By the uniqueness theorem of subsection 5, the last identity is valid everywhere in  $V$ , so that  $p_0 \in E$ .

Thus,  $E$  is nonempty and simultaneously both open and closed. Since  $M$  is connected by definition, it follows from this that  $E \equiv M$ , i.e., that  $f \equiv g$  everywhere on  $M$ . ▶

**THEOREM 2 (maximum principle).** *If the function  $f \in \mathcal{O}(M)$  and  $|f|$  attains a maximum at an interior point of  $M$ , then  $f$  is constant everywhere on  $M$ .*

◀ Suppose  $|f|$  attains a maximum at the point  $p_0 \in M$ ; we consider the local parameter  $\zeta = \varphi(p)$  that acts in a neighborhood of this point. The

modulus of the function  $f \circ \varphi^{-1}(\zeta)$ , which is holomorphic at the point  $\zeta^0 = \varphi(p_0)$ , attains a maximum at this point; hence, by the maximum principle from subsection 5 the function  $f \circ \varphi^{-1}$  is constant in some neighborhood of  $\zeta^0$ , and hence  $f$  is constant in some neighborhood of  $p_0$ . By the preceding theorem  $f$  is constant on all of  $M$ . ►

**COROLLARY.** *On a compact complex manifold all holomorphic functions are constant.*

(A manifold  $M$  is said to be compact if it is compact as a topological space. On such a manifold the modulus of every continuous function attains a maximum at some point, and the assertion of the Corollary then follows immediately from Theorem 2.)

**13. Complexification of Minkowski space.** Space-time, introduced in 1908 by the German mathematician Hermann Minkowski, is the four-dimensional real space  $M$  of the points  $x = (x_0, x_1, x_2, x_3)$ , provided with the "hyperbolic" metric

$$\|x\|^2 = x_0^2 - x_1^2 - x_2^2 - x_3^2; \quad (1)$$

$x_0$  represents time, and the remaining coordinates are spatial. This space plays a fundamental role in the theory of relativity.

According to a fundamental postulate of this theory the velocities of signals cannot exceed the speed of light  $c$ , which is taken to be equal to 1. The equation  $\|x\|^2 = 0$  defines a cone in  $M$ , which is called the *light cone* with vertex  $x = 0$ . Its interior  $\{x_1^2 + x_2^2 + x_3^2 < x_0^2\}$  splits into two nappes, for which  $x_0 > 0$  and  $x_0 < 0$ , respectively, the so-called *future* and *past cones*. They consist of all the points with which the point  $x = 0$  can communicate in the future or in the past according to the above postulate; communication is impossible with points outside these cones.

In contemporary mathematical physics there has arisen the need of a **COMPLEXIFICATION** of the space  $M$ , i.e., an embedding of it into  $\mathbb{C}^4$  as a real subspace  $\mathbb{R}^4(x)$  and a completion by points  $z = x + iy$  for which  $y_1^2 + y_2^2 + y_3^2 < y_0^2$  according to that same postulate. If we consider the cones  $C_{\pm} = \{y \in \mathbb{R}^4 : y_0^2 - y_1^2 - y_2^2 - y_3^2 > 0, y_0 \gtrless 0\}$  and the tube domains over them

$$M_{\pm}^c = \{z = x + iy : x \in \mathbb{R}^4, y \in C_{\pm}\} = \mathbb{R}^4(x) + iC_{\pm}, \quad (2)$$

then we are led to the *complex Minkowski space*

$$M^c = M_+^c \cup M \cup M_-^c. \quad (3)$$

The real Minkowski space  $M$  forms the common part of the boundary of the domains  $M_{\pm}^c$  and is their Shilov boundary (see subsection 5).

The Swiss physicist **WOLFGANG PAULI** proposed that one represent the points  $x \in M$  by Hermitian matrices

$$X = \begin{pmatrix} x_0 + x_1 & x_2 + ix_3 \\ x_2 - ix_3 & x_0 - x_1 \end{pmatrix}; \quad (4)$$



the convenience of this representation is that  $\det X = \|x\|^2$ . The Pauli transformation, extended to  $\mathbb{C}^4$ ,

$$L: (z_0, z_1, z_2, z_3) \mapsto \begin{pmatrix} z_0 + z_1 & z_2 + iz_3 \\ z_2 - iz_3 & z_0 - z_1 \end{pmatrix},$$

is a nondegenerate linear transformation, whose inverse was encountered in (10) of subsection 2. It transforms the tube domains  $M_{\pm}^c$  respectively into the generalized upper and lower half-planes  $H_{\pm} = \{\text{Im } Z \gtrless 0\}$ , where

$$Z = \begin{pmatrix} z_{00} & z_{01} \\ z_{10} & z_{11} \end{pmatrix} \quad (5)$$

is a matrix representation of points of  $\mathbb{C}^4$ ,

$$\text{Im } Z = \frac{1}{2i}(Z - Z^*) = \begin{pmatrix} y_{00} & \frac{z_{01} - \bar{z}_{10}}{2i} \\ \frac{z_{10} - \bar{z}_{01}}{2i} & y_{11} \end{pmatrix}, \quad y_{jk} = \text{Im } z_{jk}, \quad (6)$$

is a Hermitian matrix, and the signs  $>$  and  $<$  mean that it is positive definite or negative definite. Under this transformation the space  $M$  itself goes to the set of Hermitian matrices  $Z$  for which  $\text{Im } Z = 0$ , i.e., to the real four-dimensional plane  $\{y_{00} = y_{11} = 0, z_{01} = \bar{z}_{10}\} \subset \mathbb{C}^4$ . For the remainder of this subsection we shall use the matrix representation of points of  $\mathbb{C}^4$ , but we shall not always distinguish between objects and their images under the Pauli transformation, considering  $M^c$  and  $L(M^c)$  as two equivalent models of complex Minkowski space. In particular, we retain the notations  $M_{\pm}^c$  and  $M$  for their images under the mapping  $L$ .

This complexification has found important applications in recent research, initiated by the English mathematician and physicist ROGER PENROSE.<sup>(6)</sup>

In physics an important role is played by conditions at infinity, and in order to study them we need to COMPACTIFY the space  $M^c$ . Penrose's proposal is to do this by embedding  $M^c$  in the Grassmann manifold  $G(3, 1)$ , whose complex dimension is also equal to 4, by formula (6) of the previous subsection. In correspondence with what was said there we represent points  $Z \in \mathbb{C}^4$  by matrices

$$\tilde{Z} = \begin{pmatrix} E \\ Z \end{pmatrix} = \begin{pmatrix} 1 & 0 \\ 0 & 1 \\ z_{00} & z_{01} \\ z_{10} & z_{11} \end{pmatrix} \quad (7)$$

and the set of them will be considered as one of the domains of the standard covering of  $G(3, 1)$ , the *affine part* of this manifold.

<sup>(6)</sup>See, for example, the collection of articles translated from the English, *Twistors and gauge fields*, "Mir", Moscow, 1983. (For a list of the articles see MR 84m:32044.)

The general points of  $G(3, 1)$  are represented by equivalence classes of  $4 \times 2$  matrices<sup>(7)</sup>

$$\tilde{Z} = \begin{pmatrix} Z_1 \\ Z_2 \end{pmatrix} \quad (8)$$

modulo the following equivalence relation:  $\tilde{Z} \sim \tilde{Z}'$  if there exists a nondegenerate  $2 \times 2$  matrix  $C$  such that  $\tilde{Z}' = \tilde{Z}C$ . The points of the affine part of  $G(3, 1)$  are represented by matrices of the form (8) for which  $\det Z_1 \neq 0$ , since for them the matrix  $\tilde{Z}Z_1^{-1} \sim \tilde{Z}$  has the form (7) with  $Z = Z_2Z_1^{-1}$ . Thus, for the compactification at infinity of  $\mathbb{C}^4$  we glue on the set of points that are representable in the form (8) with the condition that  $\det Z_1 = 0$ . In particular, we add to the real space  $M$  the set of matrices (4) for which  $\det X = x_0^2 - x_1^2 - x_2^2 - x_3^2 = 0$ , i.e., at infinity we glue on the cone from  $\mathbb{R}^4$ .

However, we are not interested in the whole space  $\mathbb{C}^4$ , but only in the part  $M^c$  defined above. In order to distinguish it we introduce the  $4 \times 4$  matrix

$$\Phi = \begin{pmatrix} 0 & -iE \\ iE & 0 \end{pmatrix}, \quad (9)$$

written in block form (here  $E$  and  $0$  are respectively the identity  $2 \times 2$  matrix and the zero  $2 \times 2$  matrix), and we consider the matrix form

$$\Phi(\tilde{Z}) = \tilde{Z}^* \Phi \tilde{Z},$$

where  $\tilde{Z}$  is a matrix of the form (8) and  $\tilde{Z}^*$  is its conjugate transpose. We note that in the affine part of  $G(3, 1)$ , where  $\tilde{Z}$  has the form (7), this form

$$\Phi(\tilde{Z}) = (E, Z^*) \begin{pmatrix} 1 & -iE \\ iE & 0 \end{pmatrix} \begin{pmatrix} E \\ Z \end{pmatrix} = -i(Z - Z^*) = 2 \operatorname{Im} Z.$$

For any matrix of the form (8) the matrix  $\Phi(\tilde{Z})$  is obviously Hermitian, and its sign does not change when  $\tilde{Z}$  is multiplied by a nondegenerate  $2 \times 2$  matrix  $C$ .<sup>(8)</sup> Therefore on the Grassmannian we can distinguish the domains

$$\tilde{M}_{\pm}^c = \{\tilde{Z} \in G(3, 1) : \Phi(\tilde{Z}) \gtrless 0\}$$

and the set

$$\tilde{M} = \{\tilde{Z} \in G(3, 1) : \Phi(\tilde{Z}) = 0\};$$

we see from the above computation for  $\tilde{Z}$  from the affine part of  $G(3, 1)$  that these are respectively compactifications of  $M_{\pm}^c$  and  $M$ . The union

$$\tilde{M}^c = \tilde{M}_{+}^c \cup \tilde{M} \cup \tilde{M}_{-}^c \quad (10)$$

is called *projective complex Minkowski space*.

In the preceding subsection we showed that the points  $\tilde{Z} \in G(3, 1)$  can be interpreted geometrically as lines in  $\mathbb{P}^3$  or as planes in  $\mathbb{C}^4$  spanned by

<sup>(7)</sup>The matrix  $\tilde{Z}$  is written in block form;  $Z_1$  and  $Z_2$  denote  $2 \times 2$  matrices.

<sup>(8)</sup>Obviously,  $\Phi(\tilde{Z}C) = C^* \Phi(\tilde{Z})C$ .

the columns of the matrix  $\tilde{Z}$ . In particular, for points of the affine part of the Grassmannian, represented by matrices  $\tilde{Z}$  of the form (7), such planes have the form

$$w = \lambda \begin{pmatrix} 1 \\ 0 \\ z_{00} \\ z_{10} \end{pmatrix} + \mu \begin{pmatrix} 0 \\ 1 \\ z_{01} \\ z_{11} \end{pmatrix},$$

where  $w$  is the column vector with coordinates  $(w_0, w_1, w_2, w_3)$  and  $\lambda$  and  $\mu$  are complex parameters. Rewriting this equality in coordinates, we will find that  $\lambda = w_0$ ,  $\mu = w_1$ , and then the equations of the plane take the form

$$\begin{aligned} w_2 &= z_{00}w_0 + z_{01}w_1 & \text{or} & & \begin{pmatrix} w_2 \\ w_3 \end{pmatrix} &= Z \begin{pmatrix} w_0 \\ w_1 \end{pmatrix}. \end{aligned} \quad (11)$$

If we take the  $w_j$  to be homogeneous coordinates in  $\mathbb{P}^3$ , then the equations (11) will be the equations of the projective line corresponding to a point  $\tilde{Z}$  of the form (7).

Starting from this classical interpretation, Penrose proposed that one pass from the complex Minkowski space  $\tilde{M}^c$  to the projective space  $\mathbb{P}^3$ , the points of which he called *twistors*. The transformation, going back to Grassmann, which associates to each point  $\tilde{Z} \in \tilde{M}^c$  the corresponding projective line  $l \in \mathbb{P}^3$  is now called the *Penrose transformation*. As we just saw, in the affine part  $M^c \subset \tilde{M}^c$ , where the points are represented by matrices  $Z$  of the form (5), the Penrose transformation has the form

$$p: Z \rightarrow l = \left\{ w \in \mathbb{P}^3 : \begin{pmatrix} w_2 \\ w_3 \end{pmatrix} = Z \begin{pmatrix} w_0 \\ w_1 \end{pmatrix} \right\}. \quad (12)$$

\* Prove that in the chart of  $G(3, 1)$  in which  $\tilde{Z} = \begin{pmatrix} Z \\ E \end{pmatrix}$  the Penrose transformation has the form  $p: Z \rightarrow \{(w_i) = Z(w_j)\}$ . \*

For a more detailed description of the Penrose transformation we remark that using the matrix (9) we can also introduce a Hermitian form in twistor space  $\mathbb{P}^3$ :

$$\begin{aligned} \Phi(w) &= w^* \Phi w = i(w_0 \bar{w}_2 + w_1 \bar{w}_3 - \bar{w}_0 w_2 - \bar{w}_1 w_3) \\ &= -2 \operatorname{Im}(w_0 \bar{w}_2 + w_1 \bar{w}_3) \end{aligned}$$

(here  $w$  is a column vector of homogeneous coordinates). This form defines a real hypersurface  $N$  in  $\mathbb{P}^3$ ,

$$N = \{w \in \mathbb{P}^3 : \operatorname{Im}(w_0 \bar{w}_2 + w_1 \bar{w}_3) = 0\}, \quad (13)$$

which divides  $\mathbb{P}^3$  into two domains

$$D_{\pm} = \{w \in \mathbb{P}^3 : \Phi(w) \gtrless 0\}. \quad (14)$$

\* Prove that by a nondegenerate linear transformation we can map  $N$  into the hypersurface

$$N' = \{w \in \mathbb{P}^3 : |w_0|^2 + |w_1|^2 - |w_2|^2 - |w_3|^2 = 0\}. *$$

Penrose calls the points  $w \in D_{\pm}$  *positive* and *negative twistors* respectively, and the points  $w \in N$  *null twistors*.

**THEOREM 1.** *The Penrose transformation takes points from  $\tilde{M}^c$  into lines that lie wholly in the domains  $D_{\pm}$  of positive and negative twistors, respectively, and the points of  $\tilde{M}$  into lines on the hypersurface  $N$  of null twistors.*

◀ We shall prove this for points of the affine part of  $\tilde{M}^c$ ; there the Penrose transformation has the form (12) and hence, for points  $w$  on the line  $l = p(Z)$  we have

$$\begin{aligned} \Phi(w) &= \left( \begin{pmatrix} w_0 \\ w_1 \end{pmatrix}^*, \begin{pmatrix} w_0 \\ w_1 \end{pmatrix}^* Z^* \right) \begin{pmatrix} 0 & -iE \\ iE & 0 \end{pmatrix} \begin{pmatrix} \begin{pmatrix} w_0 \\ w_1 \end{pmatrix} \\ Z \begin{pmatrix} w_0 \\ w_1 \end{pmatrix} \end{pmatrix} \\ &= -i \begin{pmatrix} w_0 \\ w_1 \end{pmatrix}^* (Z - Z^*) \begin{pmatrix} w_0 \\ w_1 \end{pmatrix}. \end{aligned}$$

From this we see that if  $-i(Z - Z^*) = 2 \operatorname{Im} Z \geq 0$  then also  $\Phi(w) \geq 0$ . ▶

Thus, each of the domains  $D_{\pm} \subset \mathbb{P}^3$  contains a family of projective lines, which depends on four complex parameters (the elements of the matrix  $Z$ ), and the hypersurface  $N$  contains such a family, depending on four complex parameters (elements of the Hermitian matrix  $Z$ ,  $\operatorname{Im} Z = 0$ ).

Theorem 1 is illustrated schematically in Figure 14; in it  $\tilde{M}$  is shown as a line and  $N$  as a hyperboloid (cf. the Exercise preceding Theorem 1 above). We note that the Penrose transformation is defined not only in  $\tilde{M}^c$ , but also in all of  $G(3, 1)$ ; however, it takes the points of  $G(3, 1) \setminus \tilde{M}^c$  into projective lines, which intersect  $N$  and lie partially in  $D_+$  and partially in  $D_-$ .

For later use we need a condition for the intersection of the two lines corresponding to the points of one chart of  $G(3, 1)$ , say from the affine part, where these points are represented by matrices  $Z$  and  $Z'$  of the form (5).

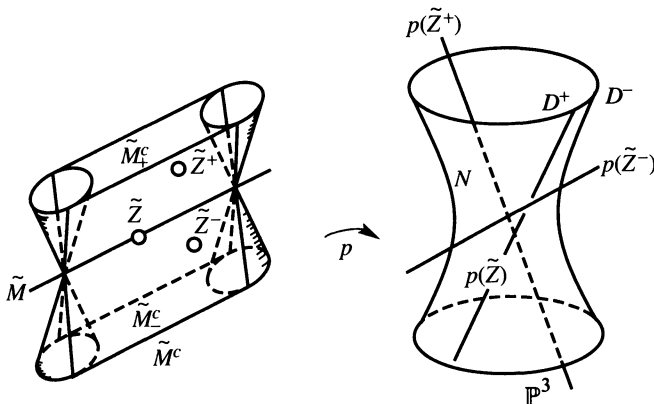

FIGURE 14

The intersection condition is that the system formed from (11) and the analogous equation with the matrix  $Z'$  has a nonzero solution (the homogeneous coordinates of the point of intersection are not all equal to 0):

$$\det \begin{pmatrix} Z & -E \\ Z' & -E \end{pmatrix} = \det(Z' - Z) = 0. \quad (14)$$

We note that if  $Z' \neq Z$ , then the rank of this system under condition (14) is equal to 3, i.e., its solution  $(w_0, w_1, w_2, w_3)$  is determined up to a scalar factor—the point of intersection of the lines  $p(Z)$  and  $p(Z')$  is unique.

Thus, if  $p(Z^0) = l_0$ , then to the points  $Z = Z^0 + V$  correspond lines intersecting  $l_0$  if and only if  $\det V = 0$ . The complex hypersurface

$$C_{Z^0} = \{Z = Z^0 + V : \det V = 0\}$$

in the space  $\mathbb{C}^4$  is called the *complex light cone* with vertex  $Z^0$ .

It is easy to see that the  $2 \times 2$  matrices  $V$  for which  $\det V = 0$  are characterized by the possibility of being represented in the form

$$V = \begin{pmatrix} \alpha_0 \beta_0 & \alpha_0 \beta_1 \\ \alpha_1 \beta_0 & \alpha_1 \beta_1 \end{pmatrix} = \begin{pmatrix} \alpha_0 \\ \alpha_1 \end{pmatrix} (\beta_0, \beta_1),$$

where  $\alpha_j, \beta_j \in \mathbb{C}$ .<sup>(9)</sup> Therefore the points of the cone  $C_{Z^0}$  admit the representation

$$\begin{aligned} z_{00} &= z_{00}^0 + \alpha_0 \beta_0, & z_{01} &= z_{01}^0 + \alpha_0 \beta_1, \\ z_{10} &= z_{10}^0 + \alpha_1 \beta_0, & z_{11} &= z_{11}^0 + \alpha_1 \beta_1; \end{aligned} \quad (15)$$

from this we see that on this cone there are two families of complex two-dimensional planes: the family of  $\alpha$ -planes  $\{\Pi_\beta\}$ , on which the value of  $\beta = (\beta_0, \beta_1)$  is fixed and the parameter is the variable  $\alpha = (\alpha_0, \alpha_1) \in \mathbb{C}^2$ , and the family of  $\beta$ -planes  $\{\Pi_\alpha\}$  with fixed  $\alpha$  and variable  $\beta$  (the fact that these are indeed planes is seen from the linear dependence on the parameters).

\* Prove that each  $\alpha$ -plane intersects each  $\beta$ -plane (for fixed  $Z^0$ ) in a complex line—a complex light ray. \*

**THEOREM 2.** For a fixed vertex  $Z^0$  the Penrose transformation  $p$  associates some point (twistor) in  $\mathbb{P}^3$  to each  $\alpha$ -plane  $\Pi_\beta \subset C_{Z^0}$ , and a plane in  $\mathbb{P}^3$  to each  $\beta$ -plane  $\Pi_\alpha$ , i.e., a point of the dual<sup>(10)</sup> space  $(\mathbb{P}^3)^*$  (See Figure 15.)

<sup>(9)</sup>In fact, it follows immediately from this representation that  $\det V = 0$ ; conversely, if  $\det(a_{jk}) = 0$ , then from the system  $\alpha_0 \beta_0 = a_{00}, \dots, \alpha_1 \beta_1 = a_{11}$  we find the ratios of the quantities  $\alpha_0, \dots, \beta_1$  to one of them.

<sup>(10)</sup>The dual to the projective space  $\mathbb{P}^n$  is the set  $(\mathbb{P}^n)^*$  of all its complex hyperplanes: the plane  $\{a_0 w_0 + \dots + a_n w_n = 0\} \subset \mathbb{P}^n$  is associated to the point in  $(\mathbb{P}^n)^*$  with homogeneous coordinates  $(a_0, \dots, a_n)$ .

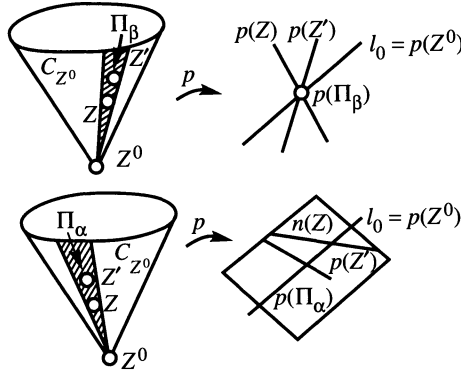

FIGURE 15

◀ The intersection of the lines  $l_0 = p(Z^0)$  and  $l = p(Z^0 + V)$  is determined by the system

$$\begin{aligned} \begin{pmatrix} w_2 \\ w_3 \end{pmatrix} &= Z^0 \begin{pmatrix} w_0 \\ w_1 \end{pmatrix}, \\ \begin{pmatrix} w_2 \\ w_3 \end{pmatrix} &= Z^0 \begin{pmatrix} w_0 \\ w_1 \end{pmatrix} + \begin{pmatrix} \alpha_0 \\ \alpha_1 \end{pmatrix} (\beta_0, \beta_1) \begin{pmatrix} w_0 \\ w_1 \end{pmatrix}. \end{aligned} \quad (16)$$

In order to obtain the images of the points of the plane  $\Pi_\beta$ , we need to eliminate  $\alpha$  from this system. But using the first equation of the system, the second can be rewritten in the form

$$\begin{pmatrix} \alpha_0 \\ \alpha_1 \end{pmatrix} (\beta_0 w_0 + \beta_1 w_1) = 0,$$

and since for  $Z \neq Z^0$  the quantities  $\alpha_0$  and  $\alpha_1$  are not both equal to 0, then  $\beta_0 w_0 + \beta_1 w_1 = 0$  and for fixed  $\beta$  the ratio  $w_1/w_0$  is uniquely determined from this; then from the first equation we find  $w_2/w_0$  and  $w_3/w_0$ . Therefore for all points  $Z \in \Pi_\beta$  the point of intersection of  $l = p(Z)$  with the line  $l_0 = p(Z^0)$  will be exactly the same. This point can be taken as the point corresponding to  $\Pi_\beta$  under the Penrose transformation.

In order to find the image of the  $\beta$ -plane  $\Pi_\alpha$ , we need to eliminate the parameters  $\beta_0$  and  $\beta_1$  from the second equation of (16) for fixed  $\alpha$ . This can be done by multiplying the first row of it by  $\alpha_1$ , the second by  $-\alpha_0$ , and adding; we obtain

$$\alpha_1 w_2 - \alpha_0 w_3 = (z_{00}^0 \alpha_1 - z_{10}^0 \alpha_0) w_0 + (z_{01}^0 \alpha_1 - z_{11}^0 \alpha_0) w_1.$$

This is a plane in  $\mathbb{P}^3$  that passes through the line  $l_0 = p(Z^0)$  and contains all the lines corresponding to the point  $Z \in \Pi_\alpha$  for fixed  $\alpha$ . Therefore we may assume that  $p$  associates the plane  $\Pi_\alpha$  to it. ▶

We now describe in more detail the restriction of the Penrose transformation to real Minkowski space,  $p: \widetilde{M} \rightarrow N$ . As is seen from (13), the complex line  $l_\infty = \{w_0 = w_1 = 0\}$  corresponding to the point  $\begin{pmatrix} 0 \\ E \end{pmatrix}$  lies on

$N$ ; see the Exercise following formula (12) of this subsection. The lines on  $N$  that intersect it correspond to the points  $\begin{pmatrix} X \\ E \end{pmatrix}$ , where  $X$  is a Hermitian matrix and  $\det X = 0$ ; these are the same elements that were added to the space  $M$  in compactifying it. The remaining points, corresponding to lines in  $N \setminus I_\infty$ , form the affine part  $M \subset \widetilde{M}$ . As above, they are represented by the Hermitian matrices

$$X = \begin{pmatrix} u & \zeta \\ \bar{\zeta} & v \end{pmatrix},$$

where  $u = x_0 + x_1$  and  $v = x_0 - x_1$  are real, and  $\zeta = x_2 + ix_3$  is a complex number.

The square of the Minkowski distance  $\|X' - X''\|^2 = \det(X' - X'')$  between the points  $X', X'' \in M$  characterizes the distance in  $\mathbb{P}^3$  between the corresponding lines  $l' = p(X')$  and  $l'' = p(X'')$ ; for Hermitian matrices this quantity is real. The restriction to  $M$  of the complex light cone with vertex  $X^0 \in M$ , the so-called *light cone*  $K_{X^0} = C_{X^0} \cap M$ , consists of the points of the form  $X^0 + Y$ , where  $Y$  is a Hermitian matrix with determinant zero. These points lie at zero distance from  $X^0$ ; therefore  $K_{X^0}$  is also called the *isotropy cone*. The Hermitian matrices with determinant zero have the form

$$Y = \begin{pmatrix} u & \zeta \\ \bar{\zeta} & |\zeta|^2/u \end{pmatrix}$$

and depend on three real parameters; therefore the cone  $K_{X^0}$  has real dimension three. It consists of the real lines  $\{X = X^0 + tY : t \in \mathbb{R}\}$ , called *light rays*; the Penrose transformation maps the points of such a ray into lines on  $N$  that intersect  $l_0 = p(X^0)$  at one point. In this sense we can say that the Penrose transformation on  $M$  maps light rays into null twistors, i.e., points of  $N$  ("collapses" these rays).

Finally, we will describe the biholomorphic automorphisms of the Minkowski space  $\widetilde{M}^c$ . We consider first the group  $\Gamma$  of linear transformations of  $G(3, 1)$  that preserve the form  $\Phi$  and, hence, leave the sets  $\widetilde{M}_+^c$ ,  $\widetilde{M}$ , and  $\widetilde{M}_-^c$  invariant. We give such automorphisms in the form

$$\widetilde{Z} \rightarrow g\widetilde{Z}, \quad (17)$$

where

$$g = \begin{pmatrix} D & C \\ B & A \end{pmatrix}$$

is a nondegenerate  $4 \times 4$  matrix, and the blocks  $D, \dots, A$  are all  $2 \times 2$ . In the affine part of  $G(3, 1)$  these automorphisms can be rewritten in the form

$$\begin{pmatrix} E \\ Z \end{pmatrix} \rightarrow \begin{pmatrix} D + CZ \\ B + AZ \end{pmatrix} \sim \begin{pmatrix} E \\ W \end{pmatrix}, \quad W = (AZ + B)(CZ + D)^{-1}, \quad (18)$$

i.e., they are given using a linear-fractional matrix function.

The condition that the form  $\Phi(\tilde{Z}) = \tilde{Z}^* \Phi \tilde{Z}$  be preserved under the mapping (17)  $\tilde{Z}^* g^* \Phi g \tilde{Z} = \tilde{Z}^* \Phi \tilde{Z}$  leads to the matrix identity  $g^* \Phi g = \Phi$ , or, using formulas (9) and (17),

$$\begin{pmatrix} D^* & B^* \\ C^* & A^* \end{pmatrix} \begin{pmatrix} 0 & -iE \\ iE & 0 \end{pmatrix} \begin{pmatrix} D & C \\ B & A \end{pmatrix} = \begin{pmatrix} 0 & -iE \\ iE & 0 \end{pmatrix}.$$

This is equivalent to the conditions

$$D^* B = B^* D, \quad C^* A = A^* C, \quad A^* D - C^* B = E \quad (19)$$

(the fourth equality  $D^* A - B^* C = E$  holds automatically; it follows from the third). These equalities coincide with (15) from subsection 10, and hence, the group  $\Gamma$  in the affine part of  $G(3, 1)$  coincides with the group  $\Gamma$  considered there.

In particular, in that subsection we distinguished the subgroup  $\Gamma_0$  of entire linear transformations

$$Z \rightarrow AZA^* + B, \quad (20)$$

where  $A$  is an arbitrary nondegenerate matrix and  $B$  is Hermitian,<sup>(11)</sup> and also a series of transformations with a nondegenerate matrix  $C$ , which according to (18) of subsection (10) are written in the form

$$Z \rightarrow B - C(Z - D)^{-1} C^*, \quad (21)$$

where  $B$  and  $D$  are Hermitian matrices. The remaining part of  $\Gamma$  consists of yet another series of transformations, for which the matrix  $C$  is degenerate but different from zero.

\* Prove that this series includes the transformation

$$W = \frac{1}{z_{00}} \begin{pmatrix} 1 & z_{01} \\ z_{10} & \det Z \end{pmatrix},$$

for which in (19) the matrices

$$A = D = \begin{pmatrix} 0 & 0 \\ 0 & 1 \end{pmatrix}, \quad C = -B = \begin{pmatrix} 1 & 0 \\ 0 & 0 \end{pmatrix}$$

are degenerate (but the matrix  $g$  from (17) is not degenerate). \*

**THEOREM 3.** *The mappings belonging to  $\Gamma$  are biholomorphic in the domains  $M_{\pm}^c$ .*

◀ The mappings belonging to  $\Gamma_0$  are biholomorphic in all of  $\mathbb{C}^4$ . The mappings of the series (21) have a singularity on the cone  $\det(Z - D) = 0$ , but since  $D$  is a Hermitian matrix, then  $\text{Im}(Z - D) = \text{Im} Z$ , and hence,  $Z - D \in M_{\pm}^c$  together with  $Z$ ; but these domains do not contain degenerate matrices

<sup>(11)</sup>In formulas (20) and (21) we have changed notation: the matrices  $B$  and  $D$  in them are different from those in (19).



(see the Exercise following equation (17) of subsection 10). Therefore the cone  $\det(Z - D) = 0$  belongs to the boundaries of  $M_{\pm}^c$ .

The mappings that belong to  $\Gamma$  with a degenerate  $C \neq 0$  are reduced by a transformation from  $\Gamma_0$  to a form in which the matrix  $C$  is diagonal and the same as in the preceding exercise. Then, using condition (19) we can show that the singularity of the mapping coincides with the plane  $z_{00} + d_{00} = 0$ , where  $d_{00}$  is a real number, and this plane cannot belong to the domains  $M_{\pm}^c$ , since  $y_{00} = 0$  on it. ►

**THEOREM 4.** *The mappings that belong to  $\Gamma$  transform the light cones with vertex at  $Z^0 \in M_{\pm}^c$  into light cones with vertex at the corresponding point  $W^0$ .*

◀ Let  $W = (AZ + B)(CZ + D)^{-1}$  and  $W^0 = (AZ^0 + B)(CZ^0 + D)^{-1}$ ; since  $M_{\pm}^c$  does not contain degenerate matrices and the mappings from  $\Gamma$  are holomorphic in these domains, the matrices  $AZ^0 + B$  and  $CZ^0 + D$  are nondegenerate. Therefore we have the identity

$$\begin{aligned} (AZ^0 + B)^{-1}(W - W^0)(CZ^0 + D) \\ = (AZ^0 + B)^{-1}(AZ + B)(CZ + D)^{-1}(CZ^0 + D) - E. \end{aligned}$$

Setting  $Z - Z^0 = \Delta$  in it, after simple transformations we obtain that all the terms in the right-hand side contain the factor  $\Delta$  on the right. Therefore, if  $\det \Delta = 0$  we certainly have  $\det(W - W^0) = 0$ . ►

Finally, we note that on real Minkowski space  $M$  we can introduce the so-called *Lorentz metric*, whose quadratic form is

$$ds^2 = \det(dX). \quad (22)$$

**THEOREM 5.** *The restrictions to  $M$  of mappings from  $\Gamma$  are conformal in the Lorentz metric everywhere where they are not degenerate.*

◀ By the rules for differentiating matrix functions we have from (18)

$$\begin{aligned} dW &= AdZ(CZ + D)^{-1} - (AZ + B)(CZ + D)^{-1}CdZ(CZ + D)^{-1} \\ &= [A - (AZ + B)(CZ + D)^{-1}C]dZ(CZ + D)^{-1}, \end{aligned}$$

from which for the restriction to  $M$  we get

$$\det(dY) = \det[A - (AX + B)(CX + D)^{-1}C] \det(CX + D)^{-1} \det(dX).$$

Thus, for mappings from  $\Gamma$  at points where  $\det(CX + D) \neq 0$  the form  $ds^2$  is multiplied by a factor that depends only on  $X$ , and this means that the mapping is conformal. ►

We point out in particular the subgroup  $\Pi \subset \Gamma_0$  of mappings for which  $\det A = 1$ . On the space  $M$  they reduce to isometries, i.e., motions in this space, and the set of them forms the so-called *Poincaré group*. Hence, the group  $\Pi$  consists of their extensions to the complex domain. In particular,

for  $B = 0$  we will obtain the subgroup  $\Pi_0 \subset \Pi$  consisting of extensions to the complex domain of mappings from the *Lorentz group*.

EXAMPLE. The group  $\Pi_0$  contains mappings with matrices

$$A_1 = \begin{pmatrix} e^{i\alpha/2} & 0 \\ 0 & e^{-i\alpha/2} \end{pmatrix}, \quad A_2 = \begin{pmatrix} e^{\alpha/2} & 0 \\ 0 & e^{-\alpha/2} \end{pmatrix};$$

on  $M^c$  they have the form

$$Z \rightarrow \begin{pmatrix} z_{00} & e^{i\alpha} z_{01} \\ e^{-i\alpha} z_{10} & z_{11} \end{pmatrix}, \quad Z \rightarrow \begin{pmatrix} e^{\alpha} z_{00} & z_{01} \\ z_{10} & e^{-\alpha} z_{11} \end{pmatrix},$$

and their restrictions to  $M$  reduce respectively to a rotation in the plane  $\zeta = x_2 + ix_3$ :

$$\zeta \rightarrow e^{i\alpha} \zeta$$

and to a "hyperbolic rotation" in the plane  $(x_0, x_1)$ :

$$x_0 \rightarrow x_0 \cosh \alpha + x_1 \sinh \alpha, \quad x_1 \rightarrow x_0 \sinh \alpha + x_1 \cosh \alpha.$$

\* Prove that the group  $\Gamma$  depends on 16 real parameters,  $\Gamma_0$  on 12,  $\Pi$  on ten, and  $\Pi_0$  on six. \*

**14. Stokes's formula.** First we consider a real  $n$ -dimensional manifold  $M$ ; it is assumed to be smooth, as are the other objects considered here. A *differential form* of degree  $r \leq n$  on  $M$  is an expression which:

(1) in local coordinates  $x = (x_0, \dots, x_n)$  in a neighborhood  $U \subset M$  is represented in the form

$$\omega = \sum'_I f_I dx_I, \quad (1)$$

where  $I = (i_1, \dots, i_r)$  is a multi-index, the prime on the sum means that the summation is ordered (over all indices of  $I$  such that  $1 \leq i_1 < i_2 < \dots < i_r \leq n$ ),  $f_I$  are functions defined in  $U$ , and  $dx_I = dx_{i_1} \wedge \dots \wedge dx_{i_r}$ ;

(2) under a change of coordinates  $x \rightarrow y$  takes the form

$$\omega = \sum'_J g_J dy_J \quad \text{with} \quad g_J = \sum'_I f_I \frac{\partial x_I}{\partial y_J}, \quad (2)$$

where

$$\frac{\partial x_I}{\partial y_J} = \frac{\partial(x_{i_1}, \dots, x_{i_r})}{\partial(y_{j_1}, \dots, y_{j_r})}$$

is the functional determinant.<sup>(12)</sup> The set of forms of degree  $r$  on a manifold  $M$  is denoted by  $\mathcal{F}^r(M)$ .

On a complex manifold the concept of degree can be made more precise. Forms here are locally represented in the form

$$\omega = \sum'_{I,J} f_{I,J} dz_I \wedge d\bar{z}_J, \quad (3)$$

<sup>(12)</sup>The law (2) for change of coordinates in a differential form is natural, since by the chain rule for composite functions and the laws of exterior multiplication  $dx_I = \sum'_J \frac{\partial x_I}{\partial y_J} dy_J$ ; substituting this in (1) and changing the order of summation, we obtain (2).

where  $I = (i_1, \dots, i_r)$ ,  $J = (j_1, \dots, j_s)$  are ordered multi-indices,  $dz_I = dz_{i_1} \wedge \dots \wedge dz_{i_r}$ ,  $d\bar{z}_J = d\bar{z}_{j_1} \wedge \dots \wedge d\bar{z}_{j_s}$ , and  $f_{I,J}$  are locally given smooth complex functions. Since changes of local coordinates  $z \rightarrow w$  on a complex manifold are holomorphic mappings, under such changes

$$dz_I = \sum'_K \frac{\partial z_I}{\partial w_K} dw_K, \quad d\bar{z}_J = \sum'_L \frac{\partial \bar{z}_J}{\partial \bar{w}_L} d\bar{w}_L,$$

and hence, in the new coordinates

$$\omega = \sum'_{K,L} g_{KL} dw_K \wedge d\bar{w}_L \quad \text{with} \quad g_{KL} = \sum'_{I,J} f_{I,J} \frac{\partial z_I}{\partial w_K} \frac{\partial \bar{z}_J}{\partial \bar{w}_L}. \quad (4)$$

We see that the number of differentials  $dz_j$  and  $d\bar{z}_k$  in the expression for the forms (3) does not depend on the choice of local coordinates. We shall say that  $\omega$  is a form of *bidegree*  $r, s$ , or, for short, an  $(r, s)$ -*form* if in its local expression there are  $r$  differentials  $dz_j$  and  $s$  differentials  $d\bar{z}_k$ . The set of  $(r, s)$ -forms with smooth coefficients on a complex manifold  $M$  is denoted by the symbol  $\mathcal{F}^{r,s}(M)$ ; the same set can be denoted  $\mathcal{F}^{r+s}(M)$ . Forms  $\sum' f_I dz_I$  of bidegree  $(r, 0)$  with holomorphic coefficients  $f_I$  are termed *holomorphic*.

The *operator of differentiation of forms* on a smooth<sup>(13)</sup> manifold is locally defined as a transformation  $d: \mathcal{F}^r \rightarrow \mathcal{F}^{r+1}$ , associating with the form  $\omega = \sum' f_I dx_I$  the form

$$d\omega = \sum_I df_I \wedge dx_I, \quad \text{where} \quad df_I = \sum_{\nu=1}^n \frac{\partial f_I}{\partial x_\nu} dx_\nu. \quad (5)$$

It possesses the following properties:

- (a)  $d(\omega_1 + \omega_2) = d\omega_1 + d\omega_2$  (linearity);
- (b)  $d(\omega_1 \wedge \omega_2) = d\omega_1 \wedge \omega_2 + (-1)^{\deg \omega_1} \omega_1 \wedge d\omega_2$  (Leibniz rule);
- (c)  $d^2\omega = d(d\omega) = 0$  (idempotence)

( $\deg \omega$  denotes the degree of the form  $\omega$ ). The operator of differentiation is well defined, i.e., does not depend on the choice of local coordinates (invariance of the differential).

On a complex manifold the operator of differentiation of forms  $d: \mathcal{F}^{r+s} \rightarrow \mathcal{F}^{r+s+1}$  splits into a sum of two operators  $d = \partial + \bar{\partial}$  so that  $\partial: \mathcal{F}^{(r,s)} \rightarrow \mathcal{F}^{(r+1,s)}$  and  $\bar{\partial}: \mathcal{F}^{(r,s)} \rightarrow \mathcal{F}^{(r,s+1)}$  (see subsection 3 above). From the idempotence of  $d$  we have

$$0 = d^2\omega = (\partial + \bar{\partial})(\partial\omega + \bar{\partial}\omega) = \partial^2\omega + (\bar{\partial}\partial + \partial\bar{\partial})\omega + \bar{\partial}^2\omega;$$

since each of the three terms on the right consists of forms of different bidegree, their sum can only equal zero in the case when each of them is equal to zero. Therefore,

$$\partial^2 = \bar{\partial}\partial + \partial\bar{\partial} = \bar{\partial}^2 = 0. \quad (6)$$

<sup>(13)</sup>Here and later on when we say smooth, we mean a real manifold.

The set  $\mathcal{F}^r$  of forms of degree  $r$  on a smooth manifold  $M$  can be considered as an abelian group with the operation of coefficientwise addition of forms. In it there is a subgroup  $Z^r$  consisting of *closed* forms  $\omega$  (i.e., those for which  $d\omega = 0$ ). Since  $d$  is an idempotent the set  $B^r$  of *exact* forms of degree  $r$  (which are differentials of forms from  $\mathcal{F}^{r-1}$ ) is a subgroup of  $Z^r$ . The quotient group of the group of closed forms modulo the group of exact forms

$$H^r(M) = Z^r/B^r, \quad (7)$$

is called the *rth cohomology Group* of  $M$  relative to the operator  $d$ . These groups are also denoted by  $H^r(M, \mathbb{R})$  and are called the *de Rham groups* of the manifold  $M$  (with real coefficients); if the forms have complex coefficients, then we use the notation  $H^r(M, \mathbb{C})$ . On a complex manifold analogous groups can also be constructed for the operators  $\partial$  and  $\bar{\partial}$ .

The *integral* of a form  $\omega \in \mathcal{F}^k$  on a smooth manifold  $M$  is defined for *k-dimensional cells*  $\gamma$ , i.e., smooth mappings of the *k-dimensional cube*  $Q^k = I \times \cdots \times I \subset \mathbb{R}^k$  into  $M$  (higher-dimensional analogues of a path; here  $I = [0, 1]$  is the unit interval). If the image  $\gamma(Q^k)$  lies in the limits of a coordinate neighborhood, where the form  $\omega = \sum' f_J dx_J$  ( $dx_J = dx_{j_1} \wedge \cdots \wedge dx_{j_k}$ ), then the integral of  $\omega$  over the cell  $\gamma$  is defined by the formula

$$\int_{\gamma} \omega = \int_{Q^k} \sum' f_J \circ \gamma \frac{\partial(x_{j_1}, \dots, x_{j_k})}{\partial(t_1, \dots, t_k)} dt_1 \cdots dt_k. \quad (8)$$

In the general case of a cell  $\gamma: Q^k \rightarrow M$  we need to use a *partition of unity* corresponding to the covering  $\mathcal{U} = \{U_{\alpha}\}_{\alpha \in A}$  of the atlas of  $M$ , i.e., a family of smooth functions  $e_{\alpha}: M \rightarrow [0, 1]$  such that the support of each  $e_{\alpha}$  (the closure of the set of points  $p \in M$ , where  $e_{\alpha}(p) \neq 0$ ) is compactly contained in  $U_{\alpha}$  and  $\sum_{\alpha \in A} e_{\alpha}(p) \equiv 1$  for all  $p \in M$ .<sup>(14)</sup> Using the partition of unity, we define

$$\int_{\gamma} \omega = \sum_{\alpha \in A} \int_{\gamma} \omega e_{\alpha}, \quad (9)$$

and since the form  $\omega e_{\alpha}$  is nonzero only in the confines of a coordinate neighborhood, then the integral of it is defined by formula (8). By the properties of integrals and forms this concept is well defined, i.e., does not depend on the choice of an atlas and partition of unity.

The concept of integral extends in a natural way to *k-dimensional chains*, i.e., formal linear combinations of *k-dimensional cells*  $\gamma_{\nu}: Q^k \rightarrow M$  with

<sup>(14)</sup>A partition of unity on a smooth manifold  $M$  exists for each LOCALLY FINITE covering  $\{U_{\alpha}\}_{\alpha \in A}$ , i.e., such that for each point  $p \in M$  there is a neighborhood covered by a finite number of  $U_{\alpha}$ . The requirement of local finiteness does not cause a loss of generality, since on the manifolds that we are considering any covering can be refined to a locally finite one. We remark that for locally finite coverings the number of nonzero terms in the right-hand side of (9) is finite.

integer coefficients  $n_\nu$ . Namely, the integral of a form  $\omega$  of degree  $k$  over a  $k$ -dimensional chain  $\sigma = \sum_{\nu=1}^N n_\nu \gamma_\nu$  is defined as

$$\int_\sigma \omega = \sum_{\nu=1}^N n_\nu \int_{\gamma_\nu} \omega. \quad (10)$$

Finally, we define the *boundary operator*  $\partial$ , which associates to a  $k$ -dimensional cell  $\gamma: Q^k \rightarrow M$  a  $(k-1)$ -dimensional chain  $\partial\gamma$  according to the following rule: we let  $t = (t_1, \dots, t_k)$  and for each  $j = 1, \dots, k$  we consider two  $(k-1)$ -dimensional faces  $Q_{j,0}^{k-1} = \{t \in Q^k : t_j = 0\}$  and  $Q_{j,1}^{k-1} = \{t \in Q^k : t_j = 1\}$  of the cube and we set

$$\partial\gamma = \sum_{j=1}^k (-1)^{j-1} \{\gamma|_{Q_{j,1}^{k-1}} - \gamma|_{Q_{j,0}^{k-1}}\}, \quad (11)$$

where  $\gamma|_{Q_{j,\alpha}^{k-1}}$  denotes the restriction of the mapping  $\gamma$  to the face  $Q_{j,\alpha}^{k-1}$  (see Figure 16, in which we have indicated the signs to be attached to the faces of the two-dimensional cube). The boundary of the chain  $\sigma = \sum_{\nu=1}^N n_\nu \gamma_\nu$  is defined by linearity, setting  $\partial\sigma = \sum_{\nu=1}^N n_\nu \partial\gamma_\nu$ . The boundary operator  $\partial$ , like the operator of differentiation  $d$ , is idempotent: its square  $\partial^2 = \partial \circ \partial = 0$ .<sup>(15)</sup>

The set of  $k$ -dimensional chains on a smooth manifold  $M$  can be considered as an abelian group  $\mathcal{F}_k$  with the operation of coefficient-wise addition of chains. In it there is a subgroup  $Z_k$  consisting of *cycles*, i.e., chains  $\sigma$  whose boundary  $\partial\sigma = 0$ .  $Z_k$  has a subgroup, which we denote by  $B_k$ , formed by the *boundaries*, i.e.,  $k$ -dimensional chains that are the boundaries of some  $(k+1)$ -dimensional chains. Two cycles  $\sigma', \sigma'' \in Z_k$  are said to be *homologous* if their difference  $\sigma' - \sigma'' \in B_k$ , i.e., is a boundary.

The quotient group of the group of cycles modulo the group of boundaries

$$H_k(M, \mathbb{Z}) = Z_k / B_k \quad (12)$$

is called the *kth homology group* of the manifold  $M$  (the symbol  $\mathbb{Z}$  denotes the integers, and in this expression it indicates that the chains are considered

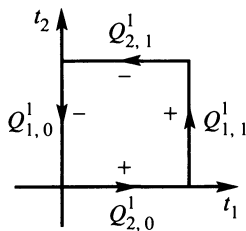

FIGURE 16

<sup>(15)</sup>The boundary operator is denoted by the same symbol as the operator of differentiation, but this does not lead to ambiguities, since it is easy to distinguish them by meaning.

with integer coefficients). The elements of this group are *homology classes*, i.e., sets of homologous cycles.

STOKES'S FORMULA connects the analytic operation of differentiation of forms with the geometric operation of taking boundaries of chains: *for any form  $\omega$  of degree  $k - 1$  on an  $n$ -dimensional manifold  $M$  ( $k \leq n$ ) the integral of  $d\omega$  over a  $k$ -dimensional chain  $\sigma: Q^k \rightarrow M$  is equal to the integral of  $\omega$  over the boundary  $\partial\sigma$ :*

$$\int_{\sigma} d\omega = \int_{\partial\sigma} \omega. \quad (13)$$

We note two important corollaries of Stokes's formula:

(1) *The integral of a closed form  $\omega$  ( $d\omega = 0$ ) over a boundary  $\sigma = \partial\sigma'$  is equal to zero:*

$$\int_{\sigma} \omega = \int_{\partial\sigma'} \omega = \int_{\sigma'} d\omega = 0. \quad (14)$$

(2) *The integral of an exact form  $\omega = d\omega'$  over a cycle  $\sigma$  ( $\partial\sigma = 0$ ) is equal to zero:*

$$\int_{\sigma} \omega = \int_{\sigma} d\omega' = \int_{\partial\sigma} \omega' = 0. \quad (15)$$

These corollaries show that the integral of a CLOSED form  $\omega$  over a CYCLE  $\sigma$  in fact depends only on the cohomology class of the forms and the homology class of the chains:

$$\int_{\sigma + \partial\sigma'} (\omega + d\omega') = \int_{\sigma} \omega. \quad (16)$$

We shall indicate one more form of Stokes's formula, connected with the concept of orientation. On a smooth  $n$ -dimensional manifold the forms of degree  $n$  locally have the form  $\omega = f dx$ , where  $dx = dx_1 \wedge \cdots \wedge dx_n$ , and we say that such a form does not vanish if the coefficient  $f$  does not vanish (this does not depend on the choice of local coordinates, since under a change of coordinates  $f$  is multiplied by the Jacobian of the change, and by the definition of a smooth manifold such Jacobians do not vanish). A manifold  $M$  is said to be *orientable* if on it there exists a form of degree  $n = \dim M$  that does not vanish; an equivalent definition: on  $M$  there exists an atlas, all of whose compatibility relations have positive Jacobians. We note that any complex manifold is orientable, since the real Jacobians of its compatibility conditions are positive (see Theorem 1 of subsection 9).

Any two forms  $\omega_1$  and  $\omega_2$  of degree  $n$  on an  $n$ -dimensional manifold  $M$  are proportional, i.e., there exists a continuous function  $\lambda: M \rightarrow \mathbb{R}$  such that  $\omega_1 = \lambda\omega_2$  (here and later we consider forms with real coefficients). If both forms do not vanish, then we also have  $\lambda \neq 0$ , and hence,  $\lambda$  has a definite sign everywhere on  $M$ . Therefore on an orientable  $n$ -dimensional manifold all the nonvanishing forms of degree  $n$  are divided into two classes such that the forms of one class differ by a positive multiple, and the forms of the other class differ by a negative multiple. In correspondence with this we can

introduce two *orientations* on an orientable manifold: under one orientation the forms of one class are taken to be positive and those of the second class to be negative, and conversely under the other orientation.

A *domain with oriented boundary* on an orientable manifold  $M$  is a domain  $D \subset M$  such that for any point  $p_0 \in \bar{D}$  either (a) there exists a neighborhood  $U \subset D$  (then  $p_0$  is called an interior point of  $D$ ), or (b) in the atlas of  $M$  there exists a chart  $(U, x)$  for which  $\bar{D} \cap U = \{p \in U : x_n(p) \leq 0\}$  (then  $p_0$  is called a boundary point of  $D$ ) (here  $x_n$  is the last coordinate of  $x$ ). The set of boundary points of  $D$  is called the *boundary* of this domain and is denoted by  $\partial D$ . The boundary  $\partial D$  turns out to be an orientable manifold of dimension  $(n-1)$ . Let  $(U, x)$  be a chart of the atlas of  $M$  such that  $U \cap \partial D \neq \emptyset$  and  $M$  is oriented so that the form  $dx = dx_1 \wedge \cdots \wedge dx_n > 0$ . If  $D$  is locally described as the set  $\{p \in U : x_n(p) < 0\}$ , then the *induced orientation* of  $\partial D$  is considered to be the one for which the form  $dx_1 \wedge \cdots \wedge dx_{n-1}$  has the sign  $(-1)^{n-1}$  on  $\partial D \cap U$  (see Figure 17, where for  $n = 2$  the form  $dx_1 < 0$  on  $\partial D$ , and for  $n = 3$  the form  $dx_1 \wedge dx_2 > 0$ ).

Using local coordinates and a partition of unity we introduce the concept of an integral over a domain with orientable boundary, and then Stokes's formula takes the form: *for any form  $\omega$  of degree  $n-1$  on an  $n$ -dimensional manifold and for a domain  $D$  on it with oriented boundary  $\partial D$*

$$\int_{\partial D} \omega = \int_D d\omega, \quad (17)$$

where the orientation of  $\partial D$  is the induced one.

In conclusion we note that Stokes's formula in the second interpretation can also be written for forms of lower degree. For this we recall that a set  $N \subset M$  is called a  *$k$ -dimensional submanifold* of  $M$  if there exists an atlas on  $M$ , for any chart  $(U, x)$  of which such that  $U \cap N \neq \emptyset$ , the intersection  $U \cap N = \{p \in U : x_{k+1}(p) = \cdots = x_n(p) = 0\}$ ; here  $k < n = \dim M$  and  $x = (x_1, \dots, x_n)$ . If the manifold  $M$  is orientable, then an orientation is locally induced on the submanifold  $N$ , and if the orientation of  $M$  is chosen so that  $dx_1 \wedge \cdots \wedge dx_n > 0$ , then the induced orientation of  $N$  is taken to be the one in which  $dx_1 \wedge \cdots \wedge dx_k > 0$ . For a form  $\omega$  of degree  $k-1$  on an

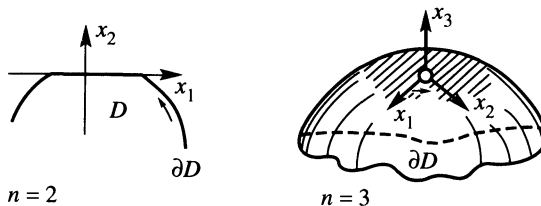

FIGURE 17

orientable manifold  $M$  of dimension  $n > k$  Stokes's formula in the form (17) can be written for domains with oriented boundary on  $k$ -dimensional submanifolds of  $M$ .

We consider Stokes's formula on complex manifolds in the following subsection.

**15. The Cauchy-Poincaré theorem.** Any  $n$ -dimensional complex manifold can be considered as a  $2n$ -dimensional real one. As local coordinates of a complex chart  $(U, z)$  it is then natural to consider the set of  $2n$  real functions  $x_\nu = \operatorname{Re} z_\nu(p)$ ,  $y_\nu = \operatorname{Im} z_\nu(p)$ . However, instead of this we can also consider the set of  $2n$  complex functions  $z_\nu(p)$ ,  $\bar{z}_\nu(p)$ , which are connected with the functions of the first set by the nondegenerate linear relations  $z_\nu = x_\nu + iy_\nu$ ,  $\bar{z}_\nu = x_\nu - iy_\nu$ .<sup>(16)</sup>

Stokes's formula of course also remains valid on complex manifolds if the operator of differentiation  $d$  is expressed in these local coordinates  $z, \bar{z}$ . The concept of a (real)  $k$ -dimensional chain is carried over to complex manifolds without change. Over such chains we can integrate  $(r, s)$ -forms of total degree  $r + s = k$  with complex coefficients, and Stokes's formula in the form (13) is preserved. For submanifolds (not necessarily complex) of a complex manifold Stokes's formula in the form (17) is also still true, provided the total degree of the form is one less than the real dimension of the submanifold and the induced orientation of the boundary is defined in the real structure.

After these explanations it is easy to prove a theorem which extends to the higher-dimensional case the fundamental theorem of Cauchy:

**THEOREM 1 (Cauchy-Poincaré).** *Let  $M$  be a complex manifold of (complex) dimension  $n$  and  $\omega$  a holomorphic form of degree  $n$  on this manifold. Then the integral of  $\omega$  over the boundary of any  $(n + 1)$ -dimensional chain  $\sigma \subset M$  is equal to zero:*

$$\int_{\partial\sigma} \omega = 0. \quad (1)$$

◀ In local coordinates  $(z, \bar{z})$ , acting in a neighborhood  $U \subset M$ , a holomorphic form has the shape  $\omega = f(z) dz_1 \wedge \cdots \wedge dz_n$ , where  $f$  is a function holomorphic in  $U$ . By the holomorphy  $\bar{\partial}f = 0$  and hence  $df = \partial f = \sum_{\nu=1}^n \frac{\partial f}{\partial z_\nu} dz_\nu$ ; by the properties of the exterior product we will therefore obtain that  $d\omega = df \wedge dz_1 \wedge \cdots \wedge dz_n = 0$ , i.e., that the form  $\omega$  is closed. By the corollary (1) of Stokes's formula from the preceding subsection we conclude that the integral (1) equals zero. ▶

**REMARK.** If we use Stokes's formula in the form (17) of the preceding subsection, then in the Cauchy-Poincaré theorem the chain  $\sigma$  can be replaced by

---

<sup>(16)</sup>The fact that the coefficients in these relations are complex is of no significance, since on  $M$  it is natural to consider complex functions and forms with complex coefficients.



a domain with oriented boundary on a real  $(n + 1)$ -dimensional submanifold of  $M$ . In particular, if  $M$  belongs to  $\mathbb{C}^n$ , then the theorem will look like:

*For any function  $f \in \mathcal{O}(D)$  and any domain  $G$  with oriented boundary on a real  $(n + 1)$ -dimensional submanifold  $M \subset D$  we have*

$$\int_{\partial G} f dz = 0, \quad dz = dz_1 \wedge \cdots \wedge dz_n \quad (2)$$

(here the coordinates act in the whole domain  $D$  and the form  $\omega$  has the form  $f dz$ ).

We note the principal difference of the higher-dimensional case from the plane case, as it relates to this theorem: for  $n = 1$  the domains  $D$  and  $G$  have the same dimension, and for  $n > 1$  the dimension of  $G$  is LOWER than the dimension of  $D$ , since  $n + 1 < 2n$ .

Here is a more special case of the theorem. Let  $f \in \mathcal{O}(D)$  and let  $G = G_1 \times \cdots \times G_n$  be a polycircular domain (the  $G_\nu$  are simply connected domains of the plane with smooth boundaries  $\partial G_\nu$ ), compactly contained in  $D$ . The skeleton of this domain  $\Gamma = \partial G_1 \times \cdots \times \partial G_n$  is the boundary of the  $(n + 1)$ -dimensional closed domains

$$S_\nu = \partial G_1 \times \cdots \times \overline{G_\nu} \times \cdots \times \partial G_n \subset\subset D.$$

Therefore, for any such domain  $G$  the integral over its skeleton

$$\int_{\Gamma} f dz = 0 \quad (3)$$

(cf. the Cauchy integral formula for polycircular domains).

Now we shall give a higher-dimensional analogue of Morera's theorem, the converse to Cauchy's theorem. In the plane case to assert that a function is holomorphic in a domain  $D$  it suffices to require that the integral over the boundaries of domains of a special form (triangles  $\Delta \subset\subset D$ ) be equal to zero, but on the function it is necessary to impose the additional condition that it be continuous (see subsection 21 of Part I). The situation is analogous in the higher-dimensional case. The role of triangles is here played by  $(n + 1)$ -dimensional "prisms"  $T_\nu$ , which are the product of a triangle  $\Delta_\nu$  lying in the plane  $\mathbb{C}^1(z_\nu)$  by the product  $\Lambda_\nu$  of straight line segments  $[a_\mu, z_\mu]$  lying in the remaining  $n - 1$  planes  $\mathbb{C}^1(z_\mu)$ ,  $\mu \neq \nu$ :

$$T_\nu = \Delta_\nu \times \Lambda_\nu \quad \left( \Lambda_\nu = \prod_{\mu \neq \nu} [a_\mu, z_\mu] \right) \quad (4)$$

(see Figure 18, where the  $z_\nu$  plane is distinguished and the space of the remaining variables  $z_\mu$  is shown schematically).

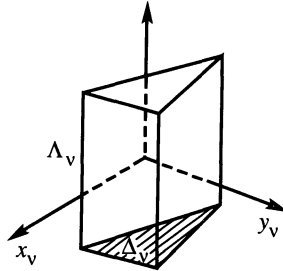

FIGURE 18

**THEOREM 2.** *If the function  $f$  is continuous in a domain  $D \subset \mathbb{C}^n$  and if for any prism  $T_\nu$  of the form (4), compactly contained in  $D$ , we have*

$$\int_{\partial T_\nu} f dz = 0, \quad (5)$$

then  $f \in \mathcal{O}(D)$ .

◀ It suffices to prove that  $f$  is holomorphic in a neighborhood of an arbitrary point  $a \in D$ . We fix  $a$  and consider the function

$$F(z) = \int_{[a_1, z_1]} d\zeta_1 \cdots \int_{[a_n, z_n]} f(\zeta) d\zeta_n; \quad (6)$$

it is defined and continuous in some neighborhood of  $a$ . For any  $\nu$  ( $\nu = 1, \dots, n$ ) it can be represented in the form

$$F(z) = \int_{[a_\nu, z_\nu]} F_\nu d\zeta_\nu,$$

where  $F_\nu$  is the integral of  $f$  over  $\Lambda_\nu$  (the product of the intervals  $[a_\mu, z_\mu]$ ,  $\mu \neq \nu$ ). The function  $F_\nu$  is obviously continuous with respect to  $\zeta_\nu$  in a neighborhood  $U_\nu$  of the point  $a_\nu$ , and by hypothesis (5) for any triangle  $\Delta_\nu \subset\subset U_\nu$  we have

$$\int_{\partial \Delta_\nu} F_\nu d\zeta_\nu = 0. \quad (7)$$

In fact, this integral can differ only by a sign from the integral

$$\int_{\partial \Delta_\nu \times \Lambda_\nu} f d\zeta = \int_{\partial T_\nu} f d\zeta,$$

where  $T_\nu = \Delta_\nu \times \Lambda_\nu$  and  $d\zeta = d\zeta_1 \wedge \cdots \wedge d\zeta_n$  (we have used the fact that on the part of  $\partial T_\nu$  different from  $\partial \Delta_\nu \times \Lambda_\nu$ , i.e., on the part  $\Delta_\nu \times \partial \Lambda_\nu$ —the set of “bases” of the prism  $T_\nu$  (see Figure 18), the coordinate  $\zeta_\nu = \text{const}$ , and hence  $d\zeta_\nu = 0$  and the integral of  $f d\zeta$  over this part of the boundary vanishes).

By Morera's theorem for functions of one variable it follows from this that  $F$  is holomorphic in the variable  $z_\nu$ . Since the argument can be applied

for any  $z_\nu$ , then  $F$  is holomorphic with respect to each variable in some neighborhood  $U$  of the point  $a$ . By Hartogs's theorem  $F$  is holomorphic in this neighborhood, and hence, the function

$$f(z) = \frac{\partial^n F}{\partial z_1 \cdots \partial z_n}$$

is also holomorphic there. ►

**16. Maxwell's equations.** We consider applications of the apparatus developed above to obtain integral representations of solutions of the famous equations of Maxwell,<sup>(17)</sup> which lie at the foundation of the theory of electromagnetism, in particular of radio engineering and optics. These equations have the form

$$\begin{aligned} \operatorname{div} H &= 0, & \operatorname{curl} E + \frac{\partial H}{\partial x_0} &= 0, \\ \operatorname{div} E &= \rho, & \operatorname{curl} H - \frac{\partial E}{\partial x_0} &= J, \end{aligned} \tag{1}$$

where  $E = (E_1, E_2, E_3)$  and  $H = (H_1, H_2, H_3)$  are the strength vectors of the electrical and magnetic fields,  $\rho$  is the density, and  $J = (J_1, J_2, J_3)$  is the current vector; the variable  $x_0$  denotes times, and the divergence and curl are taken with respect to the spatial coordinates  $x_1, x_2, x_3$ .

It is convenient to write these equations in terms of differential forms. In fact, we introduce the forms

$$\begin{aligned} F &= \sum_{k=1}^3 E_k dx_k \wedge dx_0 + \sum_{k=1}^3 H_k dx_{[k]}, \\ *F &= - \sum_{k=1}^3 H_k dx_k \wedge dx_0 + \sum_{k=1}^3 E_k dx_{[k]}, \end{aligned} \tag{2}$$

where  $dx_{[1]} = dx_2 \wedge dx_3$ ,  $dx_{[2]} = dx_3 \wedge dx_1$ ,  $dx_{[3]} = dx_1 \wedge dx_2$ . A simple calculation shows that the homogeneous Maxwell equations (in which  $\rho = J = 0$ ) express that these forms are closed:

$$dF = 0 \text{—the first pair,} \tag{3}$$

$$d * F = 0 \text{—the second pair.}^{(18)}$$

We give yet another form of these equations. The operator  $*$ :  $(E, H) \rightarrow$

<sup>(17)</sup>The well-known American physicist RICHARD FEYNMAN writes about these equations as follows: "In the history of mankind (if we look back at it, say, ten thousand years from now) the most important event of the 19th century will doubtless be Maxwell's discovery of the laws of electrodynamics. In the background of this most important scientific discovery the American Civil War in the same decade will seem like a small provincial occurrence." (*Feynman Lectures on Physics*, Addison-Wesley, Reading, MA, 1970.

<sup>(18)</sup> In the nonhomogeneous case the second pair of Maxwell equations has the form

$$d * F = - \sum_{k=1}^3 J_k dx_{[k]} \wedge dx_0 + \rho dx_1 \wedge dx_2 \wedge dx_3.$$

$(-H, E)$  is linear in the space  $\mathbb{R}^6$  of values of  $(E, H)$ , or, equivalently, in the space of 2-forms on a four-dimensional manifold  $M$ , and its square is equal to the identity transformation with a minus sign. Therefore the operator  $*$  has two eigenvalues  $\pm i$  and correspondingly, any 2-form  $\omega$  on  $M$  splits into a sum of two forms:

$$\omega^+ = \frac{1}{2}(\omega - i * \omega), \quad \omega^- = \frac{1}{2}(\omega + i * \omega),$$

for which respectively  $*\omega^+ = i\omega^+$  and  $*\omega^- = -i\omega^-$ ; they are called the *self-dual* and *anti-self-dual* parts of  $\omega$ .

In particular, for the Maxwell forms (2) the self-dual and anti-self-dual parts are

$$F^+ = \sum_{k=1}^3 \frac{E_k + iH_k}{2} dx_k \wedge dx_0 + \sum_{k=1}^3 \frac{H_k - iE_k}{2} dx_{[k]},$$

$$F^- = \sum_{k=1}^3 \frac{E_k - iH_k}{2} dx_k \wedge dx_0 + \sum_{k=1}^3 \frac{H_k + iE_k}{2} dx_{[k]},$$

or

$$F^+ = \sum_{k=1}^3 F_k (dx_k \wedge dx_0 - idx_{[k]}),$$

$$F^- = \sum_{k=1}^3 \bar{F}_k (dx_k \wedge dx_0 + idx_{[k]}),$$
(4)

where

$$F_k = \frac{1}{2}(E_k + iH_k), \quad k = 1, 2, 3. \quad (5)$$

The forms (4), defined on real Minkowski space  $M$ , can be extended to the domains  $M_{\pm}^c$  of its complexification (see subsection 13). For this we pass to the Pauli coordinates  $z_{jk}$ , by setting

$$x_0 = \frac{1}{2}(z_{00} + z_{11}), \quad x_1 = \frac{1}{2}(z_{00} - z_{11}),$$

$$x_2 = \frac{1}{2}(z_{01} + z_{10}), \quad x_3 = \frac{1}{2i}(z_{01} - z_{10})$$

(cf. (3) of subsection 13). Then

$$dx_1 \wedge dx_0 - idx_2 \wedge dx_3 = \frac{1}{2}(dz_{00} \wedge dz_{11} + dz_{01} \wedge dz_{10}),$$

$$dx_2 \wedge dx_0 - idx_3 \wedge dx_1 = \frac{1}{2}(dz_{01} \wedge dz_{11} - dz_{00} \wedge dz_{10}),$$

$$dx_3 \wedge dx_0 - idx_1 \wedge dx_2 = \frac{1}{2i}(dz_{00} \wedge dz_{10} + dz_{01} \wedge dz_{11}),$$

and the self-dual Maxwell form takes the shape

$$F^+ = f_1 dz_{00} \wedge dz_{10} + f_2 (dz_{00} \wedge dz_{11} + dz_{01} \wedge dz_{10}) + f_3 dz_{01} \wedge dz_{11}, \quad (6)$$

where  $f_1 = -(F_2 + iF_3)/2$ ,  $f_2 = F_1/2$ , and  $f_3 = (F_2 - iF_3)/2$ . Analogously the anti-self-dual Maxwell form

$$F^- = f_1^- dz_{00} \wedge dz_{01} + f_2^- (dz_{00} \wedge dz_{11} - dz_{01} \wedge dz_{10}) + f_3^- dz_{10} \wedge dz_{11}, \quad (7)$$

where  $f_k^- = \overline{f_k}$  ( $k = 1, 2, 3$ ).

In this form  $F^\pm$  extend as forms of bidegree  $(2, 0)$  into the domains  $M_\pm^c \subset \mathbb{C}^4$  if the coefficients  $f_k^\pm$  extend there. Maxwell's equations extended into the domains  $M_\pm^c$  express the conditions that these forms are closed relative to the variables  $z_{00}, \dots, z_{11}$ : the self-dual ones are

$$\frac{\partial f_1}{\partial z_{01}} = \frac{\partial f_2}{\partial z_{00}}, \quad \frac{\partial f_1}{\partial z_{11}} = \frac{\partial f_2}{\partial z_{10}}, \quad \frac{\partial f_2}{\partial z_{01}} = \frac{\partial f_3}{\partial z_{00}}, \quad \frac{\partial f_2}{\partial z_{11}} = \frac{\partial f_3}{\partial z_{10}} \quad (8)$$

and the anti-self-dual ones

$$\frac{\partial f_1^-}{\partial z_{10}} = \frac{\partial f_2^-}{\partial z_{00}}, \quad \frac{\partial f_1^-}{\partial z_{11}} = \frac{\partial f_2^-}{\partial z_{01}}, \quad \frac{\partial f_2^-}{\partial z_{10}} = \frac{\partial f_3^-}{\partial z_{00}}, \quad \frac{\partial f_2^-}{\partial z_{01}} = \frac{\partial f_3^-}{\partial z_{11}}. \quad (9)$$

Therefore in order for these equations to be satisfied the coefficients  $f_k^\pm$  should be extended so that in the forms  $dF^\pm$  derivatives with respect to the variables  $\bar{z}_{jk}$  do not appear, i.e., these coefficients should be extended HOLOMORPHICALLY with respect to the variables  $z_{jk}$ .

In the extension in the complex domain the decomposition of solutions of Maxwell's equations into self-dual and anti-self-dual parts admits a natural interpretation in terms of twistor geometry: *the self-dual forms (6) are characterized by the fact that they vanish on  $\beta$ -planes, and the anti-self-dual ones (7) vanish on  $\alpha$ -planes.*

In fact, on  $\beta$ -planes  $\Pi_\alpha$ , where  $\alpha$  is fixed and  $\beta$  is the parameter, from the relations (15) of subsection 13 we find

$$dz_{00} = \alpha_0 d\beta_0, \quad dz_{01} = \alpha_0 d\beta_1, \quad dz_{10} = \alpha_1 d\beta_0, \quad dz_{11} = \alpha_1 d\beta_1,$$

whence  $dz_{00} \wedge dz_{10} = dz_{00} \wedge dz_{11} + dz_{01} \wedge dz_{10} = dz_{01} \wedge dz_{11} = 0$ , and hence,  $F^+|_{\Pi_\alpha} = 0$ . The verification for  $\alpha$ -planes is analogous.

To obtain integral representations of solutions of Maxwell's equations we use the method developed by Penrose. In correspondence with the ideas of subsection 13 we pass via the transformation  $p$  from the domains  $M_\pm^c$  of Minkowski space to the domains  $D_\pm$  of the twistor space  $\mathbb{P}^3$ . According to (11) of subsection 13, the transformation  $p$  associates to a point  $Z$  the complex projective line

$$l = p(Z): \begin{cases} w_2 = z_{00}w_0 + z_{01}w_1, \\ w_3 = z_{10}w_0 + z_{11}w_1, \end{cases} \quad (10)$$

and if  $Z \in M_\pm^c$ , then  $l \subset D_\pm$ .

Since a line corresponds to the point  $Z$ , it is natural to look for a solution as an integral over this line. If  $\zeta$  is the complex parameter on  $l$ , then the element of integration on it has the form  $d\zeta \wedge d\bar{\zeta}$ , so that in this integration the degree of the form is lowered by  $(1, 1)$ . Since we want to obtain a  $(2, 0)$ -form, we must therefore integrate a form of bidegree  $(3, 1)$  over  $l$ .

Following a method proposed by S. G. GINDIKIN and G. M. KHENKIN,<sup>(19)</sup> we shall obtain such forms as a product  $\Omega = \omega \wedge \Omega_0$ , where

$$\begin{aligned} \Omega_0 = & w_0 dw_1 \wedge dw_2 \wedge dw_3 - w_1 dw_0 \wedge dw_2 \wedge dw_3 \\ & + w_2 dw_0 \wedge dw_1 \wedge dw_3 - w_3 dw_0 \wedge dw_1 \wedge dw_2 \end{aligned} \quad (11)$$

is the standard  $(3, 0)$ -form and

$$\omega = a_0 d\bar{w}_0 + a_1 d\bar{w}_1 + a_2 d\bar{w}_2 + a_3 d\bar{w}_3$$

is a  $(0, 1)$ -form in  $D_{\pm}$  with arbitrary coefficients. Moreover, the forms  $\omega$  and  $\Omega$  must be well defined, i.e., expressed via local coordinates in charts of  $\mathbb{P}^3$ ; for example, in the affine part, via the coordinates  $\zeta_k = w_k/w_0$ ,  $k = 1, 2, 3$ .

Since  $\omega = (a_0 \bar{w}_0 + \dots + a_3 \bar{w}_3) d\bar{w}_0 + \bar{w}_0 (a_1 d\bar{\zeta}_1 + \dots + a_3 d\bar{\zeta}_3)$ , this form is well defined if  $a_0 \bar{w}_0 + \dots + a_3 \bar{w}_3 = 0$  and the  $\bar{w}_0 a_j$  depend on the quotients  $\zeta_k = w_k/w_0$ , i.e., if the  $a_j$  are functions of *homogeneity*  $-1$  with respect to the variables  $\bar{w}_k$ . Furthermore,  $\Omega_0 = w_0^4 d\zeta_1 \wedge d\zeta_2 \wedge d\zeta_3$ , and the requirement that the form  $\Omega$  be well defined reduces to the fact that  $\bar{w}_0 a_j w_0^4$  should depend only on  $\zeta_k$ , i.e., the coefficients  $a_j$  of the form  $\omega$  should have *homogeneity*  $-4$  with respect to the variables  $w_k$ .

According to (10) the line  $l = p(Z)$  is described in affine coordinates by the equations

$$\zeta_2 = z_{00} - z_{01} \zeta_1, \quad \zeta_3 = z_{10} + z_{11} \zeta_1 \quad (12)$$

and we can take  $\zeta = \zeta_1$  to be the parameter on this line. In calculating the restriction of  $\Omega_0$  to  $l$  we should take into account not only the dependence of  $\zeta_2$  and  $\zeta_3$  on  $\zeta$ , but also their dependence on  $z_{jk}$ , so that on  $l$  we have

$$\begin{aligned} d\zeta_1 \wedge d\zeta_2 \wedge d\zeta_3 &= (dz_{00} + \zeta dz_{01} + z_{01} d\zeta) \wedge (dz_{10} + \zeta dz_{11} + z_{11} d\zeta) \wedge d\zeta \\ &= [dz_{00} \wedge dz_{10} + \zeta(dz_{00} \wedge dz_{11} + dz_{01} \wedge dz_{10}) \\ &\quad + \zeta^2 dz_{01} \wedge dz_{11}] \wedge d\zeta. \end{aligned}$$

Here the forms we need appear in the same way as they appear in expression (6) for self-dual Maxwell forms; for brevity we denote them

$$\begin{aligned} \Phi_I &= dz_{00} \wedge dz_{10}, & \Phi_{II} &= dz_{00} \wedge dz_{11} + dz_{01} \wedge dz_{10}, \\ \Phi_{III} &= dz_{01} \wedge dz_{11}. \end{aligned}$$

<sup>(19)</sup> See their paper *The Penrose transformation and complex integral geometry*, in the collection *Sovremennyye Problemy Matematiki*, Vol. 17, VINITI, Moscow, 1981, pp. 57–111; English transl., *J. Soviet Math.* 21 (1983), 508–550.

Analogously,

$$\omega|_l = \bar{w}_0[(a_1 + \bar{z}_{01}a_2 + \bar{z}_{11}a_3)d\bar{\zeta} + a_2(d\bar{z}_{00} + \bar{\zeta}d\bar{z}_{01}) + a_3(d\bar{z}_{10} + \bar{\zeta}d\bar{z}_{11})], \quad (13)$$

and since in the integration over  $l$  we need to separate out from  $\Omega$  only the terms of bidegree  $(1, 1)$  with respect to  $\zeta$ , then

$$\begin{aligned} & \int_{l=p(Z)} \omega \wedge \Omega_0 \\ &= \int_C \bar{w}_0(a_1 + \bar{z}_{01}a_2 + \bar{z}_{11}a_3) d\bar{\zeta} \wedge w_0^4(\Phi_I + \zeta\Phi_{II} + \zeta^2\Phi_{III}) \wedge d\zeta \quad (14) \\ &= \int_C w_0^4 \omega|_l \wedge (\Phi_I + \zeta\Phi_{II} + \zeta^2\Phi_{III}) \wedge d\zeta. \end{aligned}$$

In this way, to each form  $\omega$  of bidegree  $(0, 1)$  in the domains  $D_{\pm}$  with coefficients of homogeneity  $-4$  with respect to the variables  $w_j$  <sup>(20)</sup> is associated the form

$$\hat{\omega} = \int_{p(Z)} \omega \wedge \Omega_0 = f_1\Phi_I + f_2\Phi_{II} + f_3\Phi_{III} \quad (15)$$

of bidegree  $(2, 0)$  with respect to the  $z_{jk}$  and with coefficients

$$f_k(Z) = \int_C \zeta^{k-1} w_0^4 \omega|_l \wedge d\zeta, \quad k = 1, 2, 3, \quad (16)$$

defined in the domains  $M_{\pm}^c$  of complex Minkowski space (we recall that if  $Z \in M_{\pm}^c$ , then  $l = p(Z) \subset D_{\pm}$ ). The transformation

$$\mathcal{P}: \omega \rightarrow \hat{\omega} = \int_{p(Z)} \omega \wedge \Omega_0$$

is also called the *Penrose transformation*. We shall now prove that this transformation takes  $\bar{\partial}$ -closed forms  $\omega$  into solutions of Maxwell's equations.

**THEOREM 1.** *For any  $\bar{\partial}$ -closed form  $\omega$  on  $D_{\pm}$  with coefficients of class  $C^1$  and homogeneity  $-4$  with respect to the variables  $w_j$ , the form  $\hat{\omega} = \mathcal{P}(\omega)$  is a self-dual solution of Maxwell's equations in the domains  $M_{\pm}^c$ .*

◀ We need to prove that under the hypotheses of the theorem the coefficients of the form  $\hat{\omega}$  depend holomorphically on  $Z$  and that this form is closed. In local coordinates  $\zeta, \zeta_2, \zeta_3$ , the conditions for the form  $\omega = \bar{w}_0(a_1 d\bar{\zeta} + a_2 d\bar{\zeta}_2 + a_3 d\bar{\zeta}_3)$  to be  $\bar{\partial}$ -closed have the form

$$\frac{\partial a_1}{\partial \bar{\zeta}_2} = \frac{\partial a_2}{\partial \bar{\zeta}}, \quad \frac{\partial a_1}{\partial \bar{\zeta}_3} = \frac{\partial a_3}{\partial \bar{\zeta}}, \quad \frac{\partial a_2}{\partial \bar{\zeta}_3} = \frac{\partial a_3}{\partial \bar{\zeta}_2},$$

---

<sup>(20)</sup> The condition of homogeneity  $-1$  with respect to  $\bar{w}_j$  holds automatically if  $\omega$  is well defined.

and the integrand in (16) is the function

$$\begin{aligned} g_k &= \zeta^{k-1} \bar{w}_0 w_0^4 (a_1 + \bar{z}_{01} a_2 + \bar{z}_{11} a_3) \\ &= \zeta^{k-1} \bar{w}_0 w_0^4 g, \quad k = 1, 2, 3. \end{aligned} \quad (17)$$

By the chain rule, taking (12) and the conditions for  $\omega$  to be closed into account we will obtain

$$\begin{aligned} \frac{\partial g_k}{\partial \bar{z}_{00}} &= \zeta^{k-1} \bar{w}_0 w_0^4 \left( \frac{\partial a_1}{\partial \bar{\zeta}_2} + \bar{z}_{01} \frac{\partial a_2}{\partial \bar{\zeta}_2} + \bar{z}_{11} \frac{\partial a_3}{\partial \bar{\zeta}_2} \right) \\ &= \zeta^{k-1} \bar{w}_0 w_0^4 \left( \frac{\partial}{\partial \bar{\zeta}} + \bar{z}_{01} \frac{\partial}{\partial \bar{\zeta}_2} + \bar{z}_{11} \frac{\partial}{\partial \bar{\zeta}_3} \right) a_2. \end{aligned}$$

But

$$\frac{\partial}{\partial \bar{\zeta}} + \bar{z}_{01} \frac{\partial}{\partial \bar{\zeta}_2} + \bar{z}_{11} \frac{\partial}{\partial \bar{\zeta}_3} = \frac{d}{d\bar{\zeta}}$$

is the operator of total differentiation with respect to  $\bar{\zeta}$  along the line  $l$ , since, according to (12), its direction vector is  $(1, z_{01}, z_{11})$ . Therefore, differentiating under the integral sign in (16), we find

$$\frac{\partial f_k}{\partial \bar{z}_{00}} = \int_C \zeta^{k-1} w_0^4 \bar{w}_0 \frac{\partial g}{\partial \bar{z}_{00}} d\bar{\zeta} \wedge d\zeta = \int_C d(\zeta^{k-1} w_0^4 \bar{w}_0 a_2 d\zeta),$$

and since the integral here is in fact taken over the projective line  $l$ , whose boundary is empty, then by Stokes's theorem this integral is equal to 0. Analogously

$$\begin{aligned} \frac{\partial g}{\partial \bar{z}_{10}} &= \frac{\partial a_1}{\partial \bar{\zeta}_3} + \bar{z}_{01} \frac{\partial a_2}{\partial \bar{\zeta}_3} + \bar{z}_{11} \frac{\partial a_3}{\partial \bar{\zeta}_3} = \frac{da_3}{d\bar{\zeta}}, \\ \frac{\partial g}{\partial \bar{z}_{01}} &= \bar{\zeta} \frac{da_2}{d\bar{\zeta}} + a_2 = \frac{d}{d\bar{\zeta}}(\bar{\zeta} a_2), \quad \frac{\partial g}{\partial \bar{z}_{11}} = \frac{d}{d\bar{\zeta}}(\bar{\zeta} a_3), \end{aligned}$$

from which in exactly the same way we get that  $f_k$  is holomorphic with respect to the remaining variables.

Considering that the coefficients of  $f_k$  are holomorphic, the conditions for the form  $\hat{\omega}$  to be closed have the form (8). But in view of (17) and (12)

$$\frac{\partial g}{\partial z_{01}} = \left( \frac{\partial a_1}{\partial \bar{\zeta}_2} + \bar{z}_{01} \frac{\partial a_2}{\partial \bar{\zeta}_2} + \bar{z}_{11} \frac{\partial a_3}{\partial \bar{\zeta}_2} \right) \zeta = \frac{\partial g}{\partial z_{00}} \zeta,$$

and since  $g_1 \zeta = g_2$ , then, differentiating (16) under the integral sign, we will find that  $\partial f_1 / \partial z_{01} = \partial f_2 / \partial z_{00}$ . The remaining conditions of (8) are verified analogously. ►

REMARKS. 1. If  $\omega$  is not only  $\bar{\partial}$ -closed, but also  $\bar{\partial}$ -exact in  $D_{\pm}$  with coefficients of homogeneity  $-4$  with respect to  $w_j$ , then  $\mathcal{P}(\omega) = 0$ . In fact, then in the local coordinates  $\zeta, \zeta_2, \zeta_3$  the form  $w_0^4 \omega = \bar{\partial} \varphi$ , where  $\varphi$



is a function of class  $C^2$  in the affine part of  $D_{\pm}$ , and formula (16) takes the form

$$f_k(Z) = \int_{\mathbb{C}} \zeta^{k-1} \bar{\partial} \varphi|_l \wedge d\zeta = \int_{\mathbb{C}} d(\zeta^{k-1} \varphi|_l d\zeta).$$

Since the integration here is taken over a projective line, then by Stokes's formula  $f_k(Z) = 0$  for  $k = 1, 2, 3$ .

2. If the form  $\omega$  extends smoothly to  $\partial D_{\pm} = N$ , then the integration in formula (16) can also be taken over the lines  $l = p(Z)$  for  $Z \in M$ . In this case we will obtain self-dual solutions of Maxwell's equations on real Minkowski space.

3. The formulas (16) for coefficients in homogeneous coordinates on  $\mathbb{P}^3$  are rewritten as:

$$f_k(Z) = \int_{p(Z)} w_0^{3-k} w_1^{k-1} \omega|_l \wedge (w_0 dw_1 - w_1 dw_0), \quad k = 1, 2, 3; \quad (18)$$

this is verified by the simple substitution  $w_1 = w_0 \zeta$  in (18).

Now we shall show that the Penrose transformation  $\mathcal{P}$  gives all the self-dual solutions of Maxwell's equations. For this we need to study the inversion of the other Penrose transformation  $p$ , which, as we saw in subsection 13, associates to a  $4 \times 2$  matrix  $\tilde{Z} \in \widetilde{M}^c$  the plane in  $\mathbb{C}^4$  spanned by the column vectors of the matrix, or, equivalently, the line in  $\mathbb{P}^3$  passing through the points whose homogeneous coordinates are the elements of these columns. Hence, the inverse transformation  $p^{-1}$  associates to a line  $l \subset \mathbb{P}^3$ , or equivalently, a pair  $(w, v)$  of points of this line, the matrix  $\tilde{Z}$  whose columns are the vectors  $w$  and  $v$ .

For definiteness we assume that  $\Delta = w_0 v_1 - w_1 v_0 \neq 0$ ; then the matrix  $\tilde{Z}$  corresponding to the pair  $(w, v)$  can be replaced by one equivalent to it from the affine part of the Grassmannian:

$$\tilde{Z} \sim \begin{pmatrix} w_0 & v_0 \\ w_1 & v_1 \\ w_2 & v_2 \\ w_3 & v_3 \end{pmatrix} \begin{pmatrix} w_0 & v_0 \\ w_1 & v_1 \end{pmatrix}^{-1} = \begin{pmatrix} E \\ Z \end{pmatrix},$$

where

$$Z = Z(w, v) = \frac{1}{\Delta} \begin{pmatrix} w_2 v_1 - w_1 v_2 & w_0 v_2 - w_2 v_0 \\ w_3 v_1 - w_1 v_3 & w_0 v_3 - w_3 v_0 \end{pmatrix}. \quad (19)$$

Consequently, for such pairs  $(w, v)$  the inverse Penrose transformation has the form  $p^{-1}: (w, v) \rightarrow Z(w, v)$ , where the matrix  $Z$  is defined in (19).

In addition, we fiber  $\mathbb{P}^3$  into a family of nonintersecting projective lines—then the lines of this fibration will be determined by a single point and hence, the inverse Penrose transformation will also be determined by a single point on it. The desired fibration can be constructed via the so-called

*anti-involution*, which in homogeneous coordinates in  $\mathbb{P}^3$  has the form

$$\nu: (w_0, w_1, w_2, w_3) \rightarrow (-\bar{w}_1, \bar{w}_0, \bar{w}_3, -\bar{w}_2). \quad (20)$$

This is an antilinear mapping of  $\mathbb{P}^3$  onto itself, possessing the following properties:

(1) A second application of the involution  $\nu^2(w) = -w$  for all  $w \in \mathbb{P}^3$ . (Obvious.)

(2) The anti-involution preserves the domains  $D_{\pm}$  and the surface  $N$ . (Since under the anti-involution  $w_0\bar{w}_2 + w_1\bar{w}_3 \rightarrow -\bar{w}_1w_3 - \bar{w}_0w_2$ , then the form  $\Phi(w) = -2\text{Im}(w_0\bar{w}_2 + w_1\bar{w}_3)$  defining these sets is preserved; see subsection 13.)

(3) The anti-involution takes lines passing through the points  $w$  and  $\nu(w)$  into themselves (the points  $w$  and  $\nu(w)$  are transformed into  $\nu(w)$  and  $-w$ , and  $-w$  as a point of  $\mathbb{P}^3$  coincides with  $w$ ).

(4) The lines  $l$  and  $l'$  respectively passing through the points  $w, \nu(w)$  and  $w', \nu(w')$  either do not intersect or coincide. (If  $l$  and  $l'$  intersect, then there are  $\lambda_j, \lambda'_j \in \mathbb{C}$  such that  $\lambda_1 w + \lambda_2 \nu(w) = \lambda'_1 w' + \lambda'_2 \nu(w')$ . Since  $w$  and  $\nu(w)$  are distinct points of  $l$ , they are complex-linearly independent, and since  $\dim_{\mathbb{C}} \mathbb{P}^3 = 3$ , then either  $w'$  or  $\nu(w')$  is expressed linearly via them. Suppose, for example,  $w' = \lambda w + \mu \nu(w)$ ; then  $\nu(w') = \bar{\lambda} \nu(w) - \bar{\mu} w$ , i.e., the points  $w'$  and  $\nu(w')$  both belong to the line passing through  $w$  and  $\nu(w)$ , and then  $l' = l$ .)

We denote the family of projective lines in  $\mathbb{P}^3$  passing through the points  $w$  and  $\nu(w)$  by  $L_{\mathbb{E}}$  (the meaning of this notation will be explained shortly). By property (4) of the anti-involution this family fibers  $\mathbb{P}^3$  into nonintersecting lines, and in view of property (2) each of these lines wholly belongs to either  $D_+$ ,  $D_-$ , or  $N$ . A line from  $L_{\mathbb{E}}$  is completely determined by one of its points, so that on  $L_{\mathbb{E}}$  the inverse Penrose transformation is determined not by a pair, but by a single point  $w$ . In particular, for those points  $w$  for which  $\Delta = |w_0|^2 + |w_1|^2 \neq 0$ , by formula (19), where  $v = \nu(w)$ , we will obtain

$$p^{-1}: w \rightarrow Z(w) = \frac{1}{\Delta} \begin{pmatrix} w_2\bar{w}_0 - w_1\bar{w}_3 & w_0\bar{w}_3 + w_2\bar{w}_1 \\ w_3\bar{w}_0 + w_1\bar{w}_2 & w_3\bar{w}_1 - w_0\bar{w}_2 \end{pmatrix}. \quad (21)$$

From this formula we see that the inverse Penrose transformation associates to lines of the fibration  $L_{\mathbb{E}}$  points lying on the real four-dimensional plane

$$\mathbb{E} = \{Z \in \mathbb{C}^4 : z_{11} = -\bar{z}_{00}, z_{10} = \bar{z}_{01}\}. \quad (22)$$

On the other hand, by formula (10) to any point  $Z \in \mathbb{E}$  there corresponds a line  $l = \{w_2 = z_{00}w_0 + z_{01}w_1, w_3 = \bar{z}_{01}w_0 - \bar{z}_{00}w_1\}$ . But for any point  $w \in l$  the coordinates of the point  $v = \nu(w)$ , according to (20), satisfy the equations  $\bar{v}_3 = -z_{00}\bar{v}_1 + z_{01}\bar{v}_0$ ,  $-\bar{v}_2 = -\bar{z}_{01}\bar{v}_1 - \bar{z}_{00}\bar{v}_0$ ; passing from them to the complex conjugates, we see that the point  $v \in l$ , i.e.,  $l \in L_{\mathbb{E}}$ .

Thus, the Penrose transformation  $p$  establishes a one-to-one correspondence between points of the plane  $\mathbf{E}$  and lines of the fibration  $L_{\mathbf{E}}$ .

From (22) we see that for points  $Z \in \mathbf{E}$

$$\text{Im } Z = \frac{1}{2i}(Z - Z^*) = \begin{pmatrix} y_{00} & 0 \\ 0 & y_{00} \end{pmatrix}.$$

Therefore the sets

$$\mathbf{E}_{\pm} = \{Z \in \mathbf{E} : y_{00} \gtrless 0\}, \quad \mathbf{E}_0 = \{Z \in \mathbf{E} : y_{00} = 0\} \quad (23)$$

belong respectively to  $M_{\pm}^c$  and  $M$ , and hence, the transformation  $p$  takes them into lines lying in  $D_{\pm}$  or on  $N$ .

The plane  $\mathbf{E}$  has an interesting physical meaning: the inverse Pauli transformation

$$z_{00} = z_0 + z_1, \quad z_{01} = z_2 + iz_3, \quad z_{10} = z_2 - iz_3, \quad z_{11} = z_0 - z_1$$

(see subsection 13) takes it into a subset of complex Minkowski space  $M^c$  on which  $\text{Re } z_0 = \text{Im } z_1 = \text{Im } z_2 = \text{Im } z_3 = 0$ , i.e., the time  $z_0 = ix_0$  is purely imaginary, and the space coordinates  $z_k = x_k$  ( $k = 1, 2, 3$ ) are real. On this subset

$$\|Z\|^2 = -(x_0^2 + x_1^2 + x_2^2 + x_3^2) = -|x|^2$$

up to sign coincides with the Euclidean norm. Therefore  $\mathbf{E}$  is called a *Euclidean subspace* of  $M^c$ . We note also that the  $\mathbb{C}$ -linear transformation

$$\begin{aligned} z_{00} + z_{11} &= iz'_1, & z_{00} - z_{11} &= z'_2, \\ z_{01} + z_{10} &= z'_3, & z_{01} - z_{10} &= iz'_4 \end{aligned}$$

takes  $\mathbf{E}$  into the real space  $\{z' \in \mathbb{C}^4 : \text{Im } z' = 0\}$ .

This completes the preparation, and we can now begin to prove the result formulated above. For definiteness we restrict ourselves to the domain  $M_+^c$ .

**THEOREM 2.** *For any self-dual solution of Maxwell's equations*

$$F^+ = f_1 \Phi_{\text{I}} + f_2 \Phi_{\text{II}} + f_3 \Phi_{\text{III}} \quad (24)$$

in the domain  $M_+^c$  there is a form  $\omega$  of bidegree  $(0, 1)$  that is  $\bar{\partial}$ -closed in the domain  $D_+ \subset \mathbb{P}^3$ , with coefficients of homogeneity  $-4$  with respect to the variables  $w_j$ , the Penrose transformation of which coincides with this solution:  $F^+ = \mathcal{P}(\omega)$ .

◀ From given coefficients of the form (24) and the twistors  $w$  and  $v$  from  $D_+$ , using the inverse Penrose transformation (19), we construct functions  $g_k(w, v) = f_k(Z(w, v))$ ,  $k = 1, 2, 3$ , and we set

$$\varphi(w, v) = \frac{1}{(w_0 v_1 - w_1 v_0)^3} (g_1 v_1^2 - 2g_2 v_0 v_1 + g_3 v_0^2) \quad (25)$$

(we are considering the part of  $D_+$  in which  $\Delta = w_0 v_1 - w_1 v_0 \neq 0$ ). We now introduce a differential form of bidegree  $(1, 0)$

$$\omega(w, v) = \sum_{j=0}^3 \frac{\partial \varphi}{\partial w_j} dv_j$$

and consider its restriction to the fibration  $L_{\mathbb{E}}$ , i.e., we set  $v = \nu(w)$ , where  $\nu$  is the anti-involution (20); we obtain a  $(0, 1)$ -form on  $D_+$ :

$$\omega(w) = \frac{\partial \varphi}{\partial w_1} d\bar{w}_0 - \frac{\partial \varphi}{\partial w_0} d\bar{w}_1 - \frac{\partial \varphi}{\partial w_3} d\bar{w}_2 + \frac{\partial \varphi}{\partial w_2} d\bar{w}_3|_{v=\nu(w)}. \quad (26)$$

Since  $\varphi$  is a function of homogeneity  $-3$  with respect to the variables  $w_j$ , then  $\omega$  has homogeneity  $-4$  with respect to these variables. The form  $\omega$  is expressed through local coordinates on  $\mathbb{P}^3$ , and a direct but rather tedious calculation with the use of the differentiation of the composite functions  $g_k$  shows that if  $F^+$  is a solution of Maxwell's equations, then it is  $\bar{\partial}$ -closed in  $D_+$ . Thus, the form (26) satisfies the conditions imposed on the form  $\omega$  in Theorem 1.

Furthermore, on a line  $l \in L_{\mathbb{E}}$  by formula (13) we have

$$\omega|_l = \bar{w}_0 \left( -\frac{\partial \varphi}{\partial w_0} - \bar{z}_{01} \frac{\partial \varphi}{\partial w_3} + \bar{z}_{11} \frac{\partial \varphi}{\partial w_2} \right) d\bar{\zeta} + \dots$$

(we wrote out in (13) only the part essential for the integration over  $l$ ). Calculating here the derivatives of the function  $\varphi$  from (25) we will find that the expression in parentheses is equal to

$$\frac{3v_1}{\Delta^4} G - \frac{1}{\Delta^3} \left( \frac{\partial G}{\partial w_0} + \bar{z}_{01} \frac{\partial G}{\partial w_3} - \bar{z}_{11} \frac{\partial G}{\partial w_2} \right),$$

where, as before,  $\Delta = w_0 v_1 - w_1 v_0$  and  $G = g_1 v_1^2 - 2g_2 v_0 v_1 + g_3 v_0^2$ . A calculation with the use of formula (21) shows that for  $v = \nu(w)$  the expression in the last bracket is equal to zero and

$$w_0^4 \omega|_l = \frac{3\bar{w}_0^2 w_0^4}{(|w_0|^2 + |w_1|^2)^4} (g_1 \bar{w}_0^2 + 2g_2 \bar{w}_0 \bar{w}_1 + g_3 \bar{w}_1^2) + \dots$$

Under the inverse Penrose transformation the same point  $Z = Z(w)$  corresponds to all the points of the line  $l \in L_{\mathbb{E}}$ , and hence, under integration along  $l$  the coefficients  $g_k(w, \nu(w)) = f_k(Z)$  are constant. Now introducing the coordinate  $\zeta = w_1/w_0$  in the affine part of  $l$ , we finally obtain

$$w_0^4 \omega|_l = \frac{3}{(1 + |\zeta|^2)^4} (f_1 + 2\bar{\zeta} f_2 + \bar{\zeta}^2 f_3) + \dots$$

Substituting this in (16), we find that the coefficients of the Maxwell form  $\hat{\omega}$

corresponding to the form (26),

$$\hat{f}_k(Z) = 3 \left\{ f_1 \int_{\mathbb{C}} \frac{\zeta^{k-1} d\bar{\zeta} \wedge d\zeta}{(1 + |\zeta|^2)^4} + 2f_2 \frac{\zeta^{k-1} \bar{\zeta} d\bar{\zeta} \wedge d\zeta}{(1 + |\zeta|^2)^4} + f_3 \int_{\mathbb{C}} \frac{\zeta^{k-1} \bar{\zeta}^2 d\bar{\zeta} \wedge d\zeta}{(1 + |\zeta|^2)^4} \right\}, \quad k = 1, 2, 3.$$

The integrals occurring here are computed in an elementary way in polar coordinates, and by symmetry for  $k = 1$  only the first integral is nonzero, for  $k = 2$  only the second integral is nonzero, and for  $k = 3$  only the third one is. In addition it turns out that

$$\int_{\mathbb{C}} \frac{d\bar{\zeta} \wedge d\zeta}{(1 + |\zeta|^2)^4} = 2 \int_{\mathbb{C}} \frac{|\zeta|^2 d\bar{\zeta} \wedge d\zeta}{(1 + |\zeta|^2)^4} = \int_{\mathbb{C}} \frac{|\zeta|^4 d\bar{\zeta} \wedge d\zeta}{(1 + |\zeta|^2)^4},$$

and hence,  $\hat{f}_k = cf_k$  for  $k = 1, 2, 3$  with the same constant  $c$ .

Thus, if we set  $\omega = \omega(w)/c$ , where  $\omega(w)$  is defined in (26), then by Theorem 1 to the form  $\omega$  and any line  $l \in L_{\mathbb{E}}$  there will correspond a solution that coincides with the given solution  $F^+$ . It remains to note that the lines of the family  $L_{\mathbb{E}}$  in the domain  $M_+^c$  of Minkowski space correspond to points from  $\mathbb{E}_+$ , so that the coefficients  $\hat{f}_k/c$  and  $f_k$  will coincide on the whole set  $\mathbb{E}_+$ . But these coefficients are holomorphic in the domain  $M_+^c$ , and  $\mathbb{E}$  is complex-linearly equivalent to the real subspace  $\mathbb{R}^4 \subset \mathbb{C}^4$ . By the uniqueness theorem from subsection 5, we conclude that  $\hat{f}_k = cf_k$  everywhere in  $M_+^c$ , i.e., that the solution we have constructed coincides with  $F^+$  everywhere. ►

We remarked above that if the form  $\omega$  extends smoothly to  $N$ , then  $\hat{\omega} = \mathcal{P}(\omega)$  is a solution of Maxwell's equations on real Minkowski space  $M$ . However, we do not obtain all solutions on  $M$  by this method. We can only prove that any such solution is expressed by the boundary values (in a generalized sense) of solutions in the domains  $M_{\pm}^c$ .

In subsection 52 we will continue the study of Maxwell's equations and we will give integral representations for solutions of them that are more suitable for applications.

## §6. Geometry of the space $\mathbb{C}^n$

This geometry is much richer than the geometry of the complex line  $\mathbb{C}$ , and we start with a description of the basic types of submanifolds of  $\mathbb{C}^n$ , located differently with respect to the complex structure.

**17. Submanifolds of  $\mathbb{C}^n$ .** The simplest ones are the submanifolds of real codimension 1 (real hypersurfaces). Locally in a neighborhood  $U$  of any point of it such a manifold  $M$  can be defined by a single real equation:

$$M = \{z \in U : \varphi(z) = 0\}. \quad (1)$$

Assume that  $\varphi \in C^1(U)$  and that the vector

$$\nabla_z \varphi = \left( \frac{\partial \varphi}{\partial z_1}, \dots, \frac{\partial \varphi}{\partial z_n} \right) \quad (2)$$

is nonzero in  $U$ . The equation of the tangent plane  $T_a(M)$  at the point  $a$  has the form

$$\sum_{\nu=1}^n \frac{\partial \varphi}{\partial x_\nu} \Big|_a (x_\nu + \alpha_\nu) + \sum_{\nu=1}^n \frac{\partial \varphi}{\partial y_\nu} \Big|_a (y_\nu - \beta_\nu) = 0, \quad \alpha_\nu + i\beta_\nu = a_\nu,$$

or, after standard transformations,

$$\sum_{\nu=1}^n \frac{\partial \varphi}{\partial z_\nu} \Big|_a (z_\nu - a_\nu) + \sum_{\nu=1}^n \frac{\partial \varphi}{\partial \bar{z}_\nu} \Big|_a (\bar{z}_\nu - \bar{a}_\nu) = 0. \quad (3)$$

Since  $\varphi$  is a real function, then  $\frac{\partial \varphi}{\partial \bar{z}_\nu} = \overline{\frac{\partial \varphi}{\partial z_\nu}}$  and the second sum in (3) is the complex conjugate of the first one. It follows from this that the complex hyperplane

$$\sum_{\nu=1}^n \frac{\partial \varphi}{\partial z_\nu} \Big|_a (z_\nu - a_\nu) = 0 \quad (4)$$

lies in the real hyperplane  $T_a(M)$ ; this complex hyperplane is called the *complex tangent plane* and is denoted by the symbol  $T_a^c(M)$ .

Equations (3) and (4) can be rewritten in the form

$$\operatorname{Re}(z - a, \overline{\nabla_a \varphi}) = 0, \quad (z - a, \overline{\nabla_a \varphi}) = 0. \quad (5)$$

Since the real part of the Hermitian scalar product is equal to the Euclidean scalar product, we see from the first equation in (5) that the vector  $n_a = \overline{\nabla_a \varphi}$ , complex conjugate to  $\nabla_a \varphi$ , is directed along a normal<sup>(21)</sup> to  $M$ . We also note that the vector  $i\overline{\nabla_a \varphi}$  is real orthogonal to the vector  $\overline{\nabla_a \varphi}$  (since  $\operatorname{Re}(i\overline{\nabla_a \varphi}, \overline{\nabla_a \varphi}) = 0$ ) and hence, belongs to  $T_a(M)$ . Moreover, from the second equation of (5) we see that if  $z \in T_a^c(M)$ , then  $(z - a, i\overline{\nabla_a \varphi}) = 0$ , i.e.,  $z - a$  is complex orthogonal to  $i\overline{\nabla_a \varphi}$ . If we extend the complex line  $n_a^c = \{z - a = \lambda n_a, \lambda \in \mathbb{C}\}$  on the normal  $n_a$ , called the *complex normal* to  $M$  at the point  $a$ , it will intersect  $T_a(M)$  just in the vector  $i\overline{\nabla_a \varphi}$ . All this is sketched in Figure 19 on the next page.

#### EXAMPLES.

1. The complex tangent plane to the sphere  $S = \{z \in \mathbb{C}^n : |z| = R\}$  at a point  $a$  of the sphere has the equation

$$\sum_{\nu=1}^n \bar{a}_\nu (z_\nu - a_\nu) = 0 \quad \text{or} \quad \sum_{\nu=1}^n \bar{a}_\nu z_\nu = R^2,$$

since  $\sum \bar{a}_\nu a_\nu = R^2$  for  $a \in S$ .

<sup>(21)</sup> This can be explained in another way: the normal  $(\frac{\partial \varphi}{\partial x_1}, \dots, \frac{\partial \varphi}{\partial x_n}, \frac{\partial \varphi}{\partial y_1}, \dots, \frac{\partial \varphi}{\partial y_n}) \in \mathbb{R}^{2n}$  under complexification goes to the vector  $(\frac{\partial \varphi}{\partial x_1} + i\frac{\partial \varphi}{\partial y_1}, \dots, \frac{\partial \varphi}{\partial x_n} + i\frac{\partial \varphi}{\partial y_n}) = 2\overline{\nabla \varphi} \in \mathbb{C}^{2n}$ .

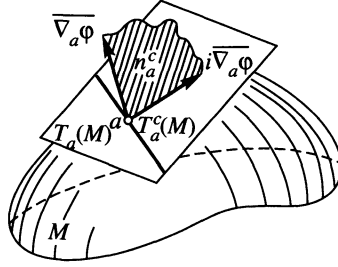

FIGURE 19

2. The real hypersurface  $N \subset \mathbb{P}^3$  with homogeneous equation  $\text{Im}(w_0 \bar{w}_2 + w_1 \bar{w}_3) = 0$  (see subsection 13) in the local coordinates  $z_\nu = w_\nu / w_0$  of the domain  $U_0 = \{[w] \in \mathbb{P}^3 : w_0 \neq 0\}$  is defined by the equation

$$\bar{z}_2 + z_1 \bar{z}_3 - z_2 - \bar{z}_1 z_3 = 0.$$

At an arbitrary point  $a \in N$  the equation of  $T_a^c(N)$  therefore has the form

$$\bar{a}_3 z_1 - z_2 - \bar{a}_1 z_3 + \bar{a}_2 = 0.$$

Passing to manifolds of real codimension  $k > 1$ , we assume that they are locally defined by  $k$  real equations

$$M = \{z \in U : \varphi_1(z) = \dots = \varphi_k(z) = 0\}, \quad (6)$$

where everywhere in  $U$

$$d\varphi_1 \wedge \dots \wedge d\varphi_k \neq 0. \quad (7)$$

In order to explain the meaning of the last condition, we again set  $y_\nu = x_{n+\nu}$ , and then (7) is rewritten in the form

$$\sum_\nu \frac{\partial(\varphi_1, \dots, \varphi_k)}{\partial(x_{\nu_1}, \dots, x_{\nu_k})} dx_{\nu_1} \wedge \dots \wedge dx_{\nu_k} \neq 0,$$

where the sum is taken over all ordered sets  $\nu = (\nu_1, \dots, \nu_k)$  of indices  $1, 2, \dots, 2n$ . From this we see that (7) expresses a condition of the maximality of the rank of the matrix  $(\frac{\partial \varphi_\mu}{\partial x_\nu})$  ( $\mu = 1, \dots, k; \nu = 1, \dots, 2n$ ), or equivalently,

$$\text{rank} \left( \frac{\partial \varphi_\mu}{\partial z_\nu}, \frac{\partial \varphi_\mu}{\partial \bar{z}_\nu} \right) = k, \quad \mu = 1, \dots, k, \nu = 1, \dots, n.$$

Thus, (7) expresses a condition of the *real-linear independence* of the vectors  $\overline{\nabla \varphi_1}, \dots, \overline{\nabla \varphi_k}$ . If this condition holds, the tangent plane  $T_a(M)$ , defined by the system of real equations

$$\text{Re}(z - a, \overline{\nabla_a \varphi_1}) = 0, \dots, \text{Re}(z - a, \overline{\nabla_a \varphi_k}) = 0 \quad (8)$$

at each point  $a \in M \cap U$  is nondegenerate: it has dimension  $m = 2n - k$ , equal to  $\dim_{\mathbb{R}} M$ .

The *complex tangent plane*  $T_a^c(M)$  is defined by the system of complex equations

$$(z - a, \overline{\nabla_a \varphi_1}) = 0, \dots, (z - a, \overline{\nabla_a \varphi_k}) = 0 \quad (9)$$

and is the set of all complex lines in  $T_a(M)$ . It can also be defined as the intersection  $T_a^c(M) \cap iT_a(M)$ , where by  $iT_a(M)$  we mean the set of vectors  $i(z - a)$  for all  $z \in T_a(M)$ . In contrast to  $T_a(M)$  the real dimension of  $T_a^c(M)$  can be different.

In particular, if

$$\partial \varphi_1 \wedge \dots \wedge \partial \varphi_k \neq 0 \quad (10)$$

in  $U$ , then  $\text{rank}(\frac{\partial \varphi_\mu}{\partial z_\nu}) = k$  and the vectors  $\overline{\nabla \varphi_1}, \dots, \overline{\nabla \varphi_k}$  are complex-linearly independent. Then we see from (9) that the complex dimension of  $T_a^c(M)$  is equal to  $n - k$ , and its real dimension  $2n - 2k < m$ ; for  $k \geq n$  this dimension is equal to 0.

However, it can happen that the vectors  $\overline{\nabla \varphi_j}$  are real-linearly independent, but complex-linearly dependent (i.e., (7) holds but (10) does not). In this case  $\dim_{\mathbb{R}} T_a^c(M)$  can be greater than  $2n - 2k$ , and in some case it can even reach  $2n - k = \dim_{\mathbb{R}} M$ .

EXAMPLE 3. In  $\mathbb{C}^2$  we consider two real two-dimensional planes  $\Pi_1 = \{z_1 = \bar{z}_2\}$  and  $\Pi_2 = \{z_1 = z_2\}$ . They are described respectively by pairs of real equations:

$$\Pi_1: x_1 - x_2 = 0, y_1 + y_2 = 0; \quad \Pi_2: x_1 - x_2 = 0, y_1 - y_2 = 0.$$

In the first case  $\overline{\nabla \varphi_1} = (1/2, -1/2)$  and  $\overline{\nabla \varphi_2} = (i/2, i/2)$  are complex-linearly independent and  $\dim_{\mathbb{R}} T^c(\Pi_1) = 0$ , and in the second case the real-linearly independent vectors  $\overline{\nabla \varphi_1} = (1/2, 1/2)$  and  $\overline{\nabla \varphi_2} = (i/2, i/2)$  are complex-linearly dependent and  $\dim_{\mathbb{R}} T^c(\Pi_2) = 2$ .

The difference of the dimensions of the tangent plane  $T(M)$  and the complex tangent plane  $T^c(M)$  characterizes the different position of submanifolds  $M$  relative to the complex structure of  $\mathbb{C}^n$ . We list the most important types of such submanifolds.

1. *Complex manifolds.* As was proved already in 1900 by T. LEVI-CIVITA this case is characterized by the dimensions of  $T(M)$  and  $T^c(M)$  being equal.

THEOREM 1. For a manifold  $M \subset \mathbb{C}^n$  of class  $C^1$

$$T_z(M) = T_z^c(M) \quad (11)$$

at each point  $z \in M$  if and only if  $M$  is a complex manifold.

◀ Suppose that the manifold  $M$  is complex and is defined locally by the equations  $f_1(z) = \dots = f_k(z) = 0$ , where the functions  $f_\mu$  are holomorphic in a neighborhood  $U \ni a$ , and that  $\text{rank}(\frac{\partial f_\mu}{\partial z_\nu}) = k$  there. Setting  $\varphi_\mu = \frac{1}{2}(f_\mu + \bar{f}_\mu)$ ,  $\varphi_{k+\mu} = \frac{1}{2i}(f_\mu - \bar{f}_\mu)$ ,  $\mu = 1, \dots, k$ , we define  $M \cap U$  by the real equations  $\varphi_1 = \dots = \varphi_{2k} = 0$ . Since  $\overline{\nabla \varphi_{k+\mu}} = i \overline{\nabla \varphi_\mu}$ , then the intersection of the tangent planes to the surfaces  $\{\varphi_\mu = 0\}$  and  $\{\varphi_{k+\mu} = 0\}$  is a complex



hypersurface. Therefore  $T(M)$ , which is the intersection of the tangent planes to the surfaces  $\{\varphi_\mu = 0\}$ ,  $\mu = 1, \dots, 2k$ , is also a complex plane.

Conversely, suppose that  $T_z(M) = T_z^c(M)$  for all  $z \in M$ . We fix a point  $a \in M$  and without loss of generality we assume that  $a = 0$  and that  $T_0(M)$  coincides with the space  $\mathbb{C}^m$  with the coordinates  $'z = (z_1, \dots, z_m)$ . Then by the implicit function theorem the manifold  $M$  is defined in a neighborhood of 0 by the system of equations  $z_\mu = f_\mu('z)$ , where  $\mu = m + 1, \dots, n$  and the  $f_\mu$  are complex functions of class  $C^1$ . It suffices to prove that  $f_\mu$  is holomorphic with respect to each variable. Therefore we denote by  $\zeta = \xi + i\eta$  any of the  $z_1, \dots, z_m$  and consider the real two-dimensional surface  $S = \{w = f(\zeta)\}$ , where  $w = (z_{m+1}, \dots, z_n)$ . The tangent plane to  $S$  at  $\zeta$  consists of the vectors

$$w - w^0 = \frac{\partial f}{\partial \zeta} \Big|_{\zeta_0} (\zeta - \zeta_0) + \frac{\partial f}{\partial \bar{\zeta}} \Big|_{\zeta_0} (\bar{\zeta} - \bar{\zeta}_0).$$

But this tangent must be a complex line (since it is the intersection of  $T(M)$  and a complex plane passing through the point  $\zeta_0$ ), and hence,  $\frac{\partial f}{\partial \bar{\zeta}} = 0$ .  $\blacktriangleright$

\* Prove that a mapping  $f: D \rightarrow \mathbb{C}^n$  of class  $C^1$  is holomorphic in the domain  $D \subset \mathbb{C}^m$  if and only if its graph  $\{(z, f(z)) \in \mathbb{C}^{m+n} : z \in D\}$  is a complex manifold. \*

2. *Maximally complex manifolds.* These are manifolds  $M$  for which at each point  $z$  the real dimensions of  $T_z(M)$  and  $T_z^c(M)$  differ by 1 (and hence,  $\dim_{\mathbb{R}} M$  is odd). As we saw above, real hypersurfaces belong to this class, and in particular, the boundaries of domains in  $\mathbb{C}^n$  if they are of class  $C^1$ . Since  $m$ -dimensional complex manifolds can be considered locally as domains in  $\mathbb{C}^m$ , this also holds for boundaries of domains on complex submanifolds of  $\mathbb{C}^n$ .

Roughly speaking, this also exhausts the class of maximally complex manifolds: recently R. HARVEY and B. LAWSON proved that any maximally complex cycle in  $\mathbb{C}^n$  (i.e., manifolds without boundary) is the boundary of some manifold, which may possibly have singularities.<sup>(22)</sup>

\* Prove that (a) a maximal complex  $\mathbb{R}$ -linear subspace  $L \subset \mathbb{C}^n$  is a real hyperplane in its complex linear hull  $L + iL$ ; (b) a maximally complex manifold  $M$  is locally in a neighborhood of a point  $a \in M$  bijectively projected into a real hyperplane of the complex linear hull of  $T_a(M)$ . \*

3. *Totally real manifolds.* These are manifolds  $M$  for which the complex plane  $T_z^c(M) = 0$  at every point  $z$ . It is easy to see that the real dimension of such manifolds is  $m \leq n$ . In fact, in a neighborhood  $U$  of a point  $a$  we define  $M$  by the equations (6), where  $k = 2n - m$ . If  $m > n$ , then  $k < n$

---

<sup>(22)</sup> Here it is assumed that the dimension of the cycle is  $m > 1$ ; in the case  $m = 1$  (real curve) the condition for maximal complexity is trivial and is replaced by something else; see R. HARVEY, *Holomorphic chains and their boundaries*, Several Complex Variables, Proc. Sympos. Pure Math., Vol. 30, Part 1, Amer. Math. Soc., Providence, RI, 1977, pp. 309–382.

and then the rank of the linear system (9) defining  $T_a^c(M)$  is less than  $n$ , i.e., this system has a nonzero solution  $z - a$ , and hence,  $T_a^c(M) \neq 0$ .

For  $m = n$  the rank of this system does not exceed  $n$  if and only if the vectors  $\overline{\nabla\varphi_1}, \dots, \overline{\nabla\varphi_n}$  are complex independent, i.e., the condition

$$\partial\varphi_1 \wedge \dots \wedge \partial\varphi_n \neq 0 \quad (12)$$

holds (cf. (10)). Thus, for  $m = n$  this condition CHARACTERIZES totally real manifolds.

Examples of totally real manifolds are the real subspace  $\mathbb{R}^n \subset \mathbb{C}^n$  and the real torus  $T^n = \{z \in \mathbb{C}^n : |z_\nu| = 1, \nu = 1, \dots, n\}$ . In the first case it is clear that  $T(\mathbb{R}^n) = \mathbb{R}^n$  does not contain even complex lines, and in the second one  $T^n$  is defined by the equations  $\varphi_\nu(z) = z_\nu \bar{z}_\nu - 1$  ( $\nu = 1, \dots, n$ ) and the vectors  $\overline{\nabla\varphi_\nu} = z_\nu$  are complex-linearly independent.

\* Prove that (a) any plane in  $\mathbb{C}^n$  is the sum of a complex plane and a totally real plane; (b) the graph  $\{(z, f(z)) \in \mathbb{C}^2 : z \in U \subset \mathbb{C}\}$  is a totally real manifold in a neighborhood of  $a \in U$  if  $\partial f / \partial \bar{z} \neq 0$  at  $a$ . \*

4. *Generating manifolds.* These are manifolds  $M$  for which at every point  $z$  the COMPLEX linear hull of the basis vectors of  $T_z(M)$  coincides with the whole space  $\mathbb{C}^n$ . Suppose that the real dimension of  $M$  is equal to  $m$ ; defining it locally, as above, by the equations (6) with  $k = 2n - m$ , we see that it will be a generating manifold if and only if the rank of the system (9) is maximal (equal to  $k$ ). In fact, if this rank is  $k' < k$ , then  $\dim_{\mathbb{C}} T_z(M) = m' = n - k'$ , and we can choose a basis in  $T_z(M)$  so that its first  $2m'$  vectors belong to  $T_z^c(M)$ . Since the complex linear hull of these vectors goes beyond the limits of  $T_z^c(M)$ , and the remaining  $m - 2m'$  vectors double their real dimension, then the complex dimension of the hull of all the basis vectors of  $T_z(M)$  is equal to  $m' + m - 2m' = m - m' = n - (k - k')$ . Thus, this hull coincides with  $\mathbb{C}^n$  exactly for  $k' = k$ .

As we saw above, the condition that the rank of the system (9) be maximal is the *complex linear independence* of the vectors  $\overline{\nabla\varphi_\nu}$ , i.e., condition (10) is precisely also the condition for the manifold  $M$  to be a generating manifold. It is clear that  $m \geq n$  for generating manifolds. In particular, all real hypersurfaces are generating manifolds. For  $m = n$  the generating manifolds are exactly the totally real ones, as is seen from (12).

\* Prove that generating manifolds are characterized by the fact that at every point of such a manifold the tangent plane is not contained in any complex hyperplane. \*

**18. Wirtinger's theorem.** We recall a little bit of linear algebra. A *Hermitian form*  $h(u, v)$  in  $\mathbb{C}^n$  is a mapping of  $\mathbb{C}^n \times \mathbb{C}^n$  into  $\mathbb{C}$  that is complex linear with respect to the first vector and satisfies the condition  $h(v, u) = \overline{h(u, v)}$  of Hermitian symmetry (and hence is antilinear with respect to the second vector). If we set  $h = g + if$ , then the relations  $g(v, u) = g(u, v)$  and  $f(v, u) = -f(u, v)$  hold, so that  $g = \operatorname{Re} h$  is a symmetric form, and  $f = \operatorname{Im} h$  is an antisymmetric form.

Let  $e^1, \dots, e^n$  be a basis of the space  $\mathbb{C}^n$  and let  $u = \sum_{\nu=1}^n \zeta_\nu(u) e^\nu$  be the expansion of  $u$  in this basis; also write the same expansion for  $v$ . In this basis the Hermitian form  $h$  is represented as

$$h(u, v) = \sum_{\mu, \nu=1}^n h_{\mu\nu} \zeta_\mu(u) \overline{\zeta_\nu(v)}, \quad (1)$$

where  $h_{\mu\nu} = h(e^\mu, e^\nu)$ , and also  $h_{\nu\mu} = \overline{h_{\mu\nu}}$ , so that the matrix  $h = (h_{\mu\nu})$  is Hermitian. In order to separate the real and imaginary parts here, we set  $\zeta_\mu = \xi_\mu + i\xi_{n+\mu}$  ( $\mu = 1, \dots, n$ ) and  $h_{\mu\nu} = h'_{\mu\nu} + ih''_{\mu\nu}$ ; after simple transformations we obtain

$$g = \operatorname{Re} h = \sum_{\mu, \nu=1}^{2n} g_{\mu\nu} \xi_\mu \xi_\nu, \quad f = \operatorname{Im} h = \sum_{\mu, \nu=1}^{2n} f_{\mu\nu} \xi_\mu \xi_\nu, \quad (2)$$

where the real matrices  $g = (g_{\mu\nu})$  and  $f = (f_{\mu\nu})$  are respectively symmetric and skew-symmetric ( $g_{\nu\mu} = g_{\mu\nu}$  and  $f_{\nu\mu} = -f_{\mu\nu}$ ).

Suppose  $h$  is a *positive* form, i.e., the form  $h(u, u) = g(u, u)$  or, equivalently, the matrix  $h = (h_{\mu\nu})$  is positive definite. Then this form gives a Hermitian scalar product  $(u, v) = h(u, v)$  in  $\mathbb{C}^n$  and the form  $g = \operatorname{Re} h$  is the Riemannian scalar product of  $u$  and  $v$ , considered as vectors in  $\mathbb{R}^{2n}$ . In particular, in the standard basis of  $\mathbb{C}^n$  the standard Hermitian form

$$h(u, v) = \sum_{\nu=1}^n z_\nu(u) \overline{z_\nu(v)}, \quad (3)$$

and its real and imaginary parts

$$\begin{aligned} g(u, v) &= \sum_{\nu=1}^n (x_\nu(u)x_\nu(v) + y_\nu(u)y_\nu(v)), \\ f(u, v) &= \sum_{\nu=1}^n (y_\nu(u)x_\nu(v) - x_\nu(u)y_\nu(v)) \end{aligned} \quad (4)$$

(setting  $z_\nu = x_\nu + iy_\nu$ ). These formulas are the same as the formulas for the scalar product  $(u, v)$  from subsection 1.

To each positive form  $h$  in the basis  $\{e^\mu\}$  and the dual basis<sup>(23)</sup> of differentials  $\{d\zeta_\nu\}$  there is a corresponding *Hermitian metric form*

$$h = \sum_{\mu, \nu=1}^n h_{\mu\nu} d\zeta_\mu \overline{d\zeta_\nu}. \quad (5)$$

In particular, the standard metric form in  $\mathbb{C}^n$  has the form

$$h = \sum_{\nu=1}^n dz_\nu \overline{dz_\nu}, \quad (6)$$

<sup>(23)</sup> This means that  $d\zeta_\mu(e^\nu) = \delta_{\mu\nu}$  is the Kronecker symbol.

so that

$$h(u, u) = g(u, u) = \sum_{\nu=1}^n |dz_\nu|^2 = ds^2. \quad (7)$$

For integration and other analytic operations it is convenient to replace the Hermitian form (5) by the corresponding *differential form*. This is done as follows: the usual products of differentials are replaced by exterior products and the factor  $i/2$  is introduced:

$$\hat{h} = \frac{i}{2} \sum_{\mu, \nu=1}^n h_{\mu\nu} d\zeta_\mu \wedge d\bar{\zeta}_\nu. \quad (5')$$

The factor ensures that the form  $\hat{h}$  is real. In fact,  $d\zeta_\mu \wedge d\bar{\zeta}_\mu = -2id\xi_\mu \wedge d\xi_{n+\mu}$ , and the coefficients  $h_{\mu\nu}$  are real because of the Hermiticity, so that all the terms of the form  $\frac{i}{2}h_{\mu\mu}d\zeta_\mu \wedge d\bar{\zeta}_\mu$  are real; that the remaining terms are real follows from the fact that for  $\mu \neq \nu$  the sums  $h_{\mu\nu}d\zeta_\mu \wedge d\bar{\zeta}_\nu + h_{\nu\mu}d\zeta_\nu \wedge d\bar{\zeta}_\mu$  are purely imaginary.<sup>(24)</sup>

In particular, to the standard Hermitian form (6) there corresponds the differential form

$$\varphi_0 = \frac{i}{2} \sum_{\nu=1}^n dz_\nu \wedge d\bar{z}_\nu = \frac{i}{2} \partial \bar{\partial} |z|^2, \quad (6')$$

where  $|z|^2 = \sum z_\nu \bar{z}_\nu$  is the Euclidean square of the modulus. For convenience of notation we introduce along with the usual operator

$$d = \partial + \bar{\partial} = \sum_{\nu=1}^n \left( \frac{\partial}{\partial x_\nu} dx_\nu + \frac{\partial}{\partial y_\nu} dy_\nu \right)$$

the operator of “conjugate differentiation”

$$d^c = \frac{\partial - \bar{\partial}}{4i} = \frac{1}{4} \sum_{\nu=1}^n \left( -\frac{\partial}{\partial y_\nu} dx_\nu + \frac{\partial}{\partial x_\nu} dy_\nu \right); \quad (8)$$

both these operators are real in the sense that their application to real functions gives a real result. The composition of these operators

$$dd^c = (\partial + \bar{\partial}) \frac{\partial - \bar{\partial}}{4i} = \frac{i}{2} \partial \bar{\partial}, \quad (9)$$

---

<sup>(24)</sup> The property of forms' being real is here understood in the sense that after transformations they reduce to combinations of real differentials  $d\xi_\mu$  with real coefficients.

so that the metric differential form (6) can be rewritten in the form<sup>(25)</sup>

$$\varphi_0 = dd^c |z|^2. \tag{10}$$

\* 1. Prove that if  $u = \operatorname{Re} f$  and  $v = \operatorname{Im} f$  are conjugate pluriharmonic functions, then  $d^c u = \frac{1}{4} dv$ .

2. For  $n = 1$  deduce from 1. that  $d^c \ln |z|^2 = \frac{1}{2} d \arg z$ .\*

The bidegree of the form  $\varphi_0$  is equal to  $(1, 1)$ , so that it can be integrated over a real two-dimensional manifold, and its exterior power  $\varphi_0^m = \varphi_0 \wedge \cdots \wedge \varphi_0$  ( $m$  times) over a real  $(2m)$ -dimensional one. It would seem to be natural that the integrals of these forms would give the volumes of the manifolds, but this is not true in general. For example, on the real two-dimensional plane  $\{z_1 = \bar{z}_2\}$  in  $\mathbb{C}^2$  we have  $dz_1 \wedge d\bar{z}_1 = -dz_2 \wedge d\bar{z}_2$ , so that the form  $\varphi_0 \equiv 0$  on it and cannot measure area.

It turns out that the form  $\varphi_0^m$  measures the volumes of COMPLEX  $m$ -dimensional manifolds, and for other real  $(2m)$ -dimensional manifolds give a value less than the volume. This fact was proved by W. WIRTINGER in 1936.

**THEOREM 1.** *Let  $M \subset \mathbb{C}^n$  be a manifold of class  $C^1$  of even real dimension  $2m$ . The volume of this manifold*

$$\operatorname{Vol} M \geq \frac{1}{m!} \int_M \varphi_0^m, \tag{11}$$

and the equality here is attained if and only if  $M$  is a complex  $m$ -dimensional manifold.

◀ It suffices to prove the inequality for volume elements<sup>(26)</sup> at an arbitrary point  $z \in M$ , for which it has the form

$$dV \geq \frac{1}{m!} \varphi_0^m|_{T_z(M)}. \tag{12}$$

Therefore, without loss of generality we can replace  $M$  by the tangent plane  $T_z(M) = T$  and consider the latter as a real  $(2m)$ -dimensional subspace of  $\mathbb{C}^{\bar{n}}$ .

<sup>(25)</sup> In the preceding calculations we have used the fact that

$$\begin{aligned} \partial &= \frac{1}{2} \sum_{\nu=1}^n \left( \frac{\partial}{\partial x_\nu} - i \frac{\partial}{\partial y_\nu} \right) (dx_\nu + idy_\nu), \\ \bar{\partial} &= \frac{1}{2} \sum_{\nu=1}^n \left( \frac{\partial}{\partial x_\nu} + i \frac{\partial}{\partial y_\nu} \right) (dx_\nu - idy_\nu), \end{aligned}$$

and also the relations  $\partial^2 = \bar{\partial}^2 = \partial\bar{\partial} + \bar{\partial}\partial = 0$  from subsection 14.

<sup>(26)</sup> In the interests of geometric intuition in this proof we understand the differentials of coordinates simply as numbers, and their exterior products as ordinary products equipped with a sign which depends on the order of the factors. For a formally impeccable proof of the theorem see, for example, the paper of Harvey cited above in footnote 22.

In  $T$  we choose real-linearly independent vectors  $z^1, \dots, z^m, w^1, \dots, w^m$ , satisfying the relations

$$(z^\mu, z^\nu) = (w^\mu, w^\nu) = \delta_{\mu\nu}, \quad (z^\mu, w^\nu) = i\alpha_\mu \delta_{\mu\nu} \quad (13)$$

for  $\mu, \nu = 1, \dots, m$ , where the parentheses denote the standard Hermitian scalar product in  $\mathbb{C}^n$ ,  $\delta_{\mu\nu}$  is the Kronecker symbol, and the  $\alpha_\mu$  are real numbers. This choice can be realized as follows. First we choose a basis  $e^1, \dots, e^{2m}$  in  $T$  that is orthonormal relative to the Euclidean metric; for it  $(e^\mu, e^\mu) = 1$  and  $\text{Re}(e^\mu, e^\nu) = 0$  for  $\mu \neq \nu$ . The skew-symmetric matrix, describing the imaginary part of the Hermitian scalar product of vectors of  $T$ , can be reduced by an orthogonal transformation of  $T$  (not violating the orthonormality) to a form in which along the principal diagonal are the cells

$$\begin{pmatrix} 0 & \alpha_\mu \\ -\alpha_\mu & 0 \end{pmatrix}, \quad \mu = 1, \dots, m,$$

and the remaining elements are equal to zero.<sup>(27)</sup> We denote the image of  $\{e^\mu\}$  under this transformation by  $z^1, w^1, \dots, z^m, w^m$ . In the new basis, besides the conditions of orthonormality for  $\mu \neq \nu$  we also have

$$\text{Im}(z^\mu, z^\nu) = \text{Im}(w^\mu, w^\nu) = \text{Im}(z^\mu, w^\nu) = 0,$$

and for  $\mu = \nu$  by formula (2) we have

$$\text{Im}(z^\mu, w^\mu) = \alpha_\mu$$

(here  $f_{2\mu-1, 2\mu} = -f_{2\mu, 2\mu-1} = \alpha_\mu$ ,  $\xi_{2\mu-1}(z^\mu) = \xi_{2\mu}(w^\mu) = 1$ , and the remaining coordinates  $z^\mu$  and  $w^\mu$  are equal to 0). Thus, all the relations of (13) hold.

In this basis the vector  $dz \in T$  is represented in the form

$$dz = \sum_{\mu=1}^m (d\xi_\mu z^\mu + d\eta_\mu w^\mu) \quad (14)$$

with real  $d\xi_\mu$  and  $d\eta_\mu$ . Since the basis is orthonormal, the volume of the parallelepiped spanned by the vectors  $d\xi_\mu z^\mu$ ,  $d\eta_\mu w^\mu$  ( $\mu = 1, \dots, m$ ) is equal to

$$dV = |d\xi_1 d\eta_1 \cdots d\xi_m d\eta_m|. \quad (15)$$

Since  $\sum_{\nu=1}^n dz_\nu \wedge d\bar{z}_\nu$  can be represented as the exterior product of the row vector  $(dz)'$ , where  $'$  denotes transposition, by the column vector  $d\bar{z}$ ,

<sup>(27)</sup> See A. I. MAL'TSEV, *Foundations of linear algebra*, 3rd ed., "Nauka", Moscow, 1970; English transl. of 2nd ed., Freeman, San Francisco, CA, 1963.

then, using (14), the restriction of the form  $\varphi_0$  to  $T$  is

$$\begin{aligned}\varphi_0|_T &= \frac{i}{2} \sum_{\mu=1}^m (d\xi_\mu z^\mu + d\eta_\mu w^\mu)' \wedge \sum_{\nu=1}^m (d\xi_\nu \bar{z}^\nu + d\eta_\nu \bar{w}^\nu) \\ &= \frac{i}{2} \sum_{\mu, \nu=1}^m \{ (z^\mu, z^\nu) d\xi_\mu \wedge d\xi_\nu + (z^\mu, w^\nu) d\xi_\mu \wedge d\eta_\nu \\ &\quad + (w^\mu, z^\nu) d\eta_\mu \wedge d\xi_\nu + (w^\mu, w^\nu) d\eta_\mu \wedge d\eta_\nu \}.^{(28)}\end{aligned}$$

Therefore, taking the relations (13) into account, and also the fact that the exterior product of identical differentials is equal to 0, we will obtain

$$\varphi_0|_T = \frac{i}{2} \sum_{\mu=1}^m d\xi_\mu \wedge d\eta_\mu [(z^\mu, w^\mu) - (w^\mu, z^\mu)] = - \sum_{\mu=1}^m \alpha_\mu d\xi_\mu \wedge d\eta_\mu.$$

Computing the  $m$ th exterior power of this sum, we find

$$\frac{\varphi_0^m}{m!} \Big|_T = (-1)^m \prod_{\mu=1}^m \alpha_\mu d\xi_1 \wedge d\eta_1 \wedge \cdots \wedge d\xi_m \wedge d\eta_m,$$

and, comparing this with (15), we see that in order to prove the inequality (12) it suffices to prove that  $|\alpha_\mu| \leq 1$  for all  $\mu = 1, \dots, m$ .

But, when we consider the relations (13) this follows directly from the Bunyakovskii-Schwarz inequality

$$|\alpha_\mu| = |(z^\mu, w^\mu)| \leq \sqrt{(z^\mu, z^\mu)(w^\mu, w^\mu)} = 1.$$

Equality occurs here if and only if the vectors  $z^\mu$  and  $w^\mu$  are complex proportional, i.e.,  $w^\mu = \lambda z^\mu$  for some  $\lambda \in \mathbb{C}$ . But in this case the real two-dimensional plane spanned by  $z^\mu$  and  $w^\mu$  is a complex line, and equality in (12) occurs if and only if all the  $|\alpha_\mu| = 1$ , i.e.,  $T$  is a complex  $m$ -dimensional plane. By Theorem 1 of subsection 17 we conclude that equality occurs in (11) if and only if  $M$  is a complex manifold. ►

<sup>(28)</sup> The same result can be obtained, separating the coordinates in (14):

$$dz_k = \sum_{\mu=1}^m (d\xi_\mu z_k^\mu + d\eta_\mu w_k^\mu), \quad k = 1, \dots, m,$$

and substituting this in the expression for  $\varphi_0$ :

$$\begin{aligned}\varphi_0|_T &= \frac{i}{2} \sum_{k=1}^n \left\{ \sum_{\mu=1}^m (d\xi_\mu z_k^\mu + d\eta_\mu w_k^\mu) \wedge \sum_{\nu=1}^m (d\xi_\nu \bar{z}_k^\nu + d\eta_\nu \bar{w}_k^\nu) \right\} \\ &= \frac{i}{2} \sum_{\mu, \nu=1}^m \left\{ d\xi_\mu \wedge d\xi_\nu \sum_{k=1}^n z_k^\mu \bar{z}_k^\nu + d\xi_\mu \wedge d\eta_\nu \sum_{k=1}^n z_k^\mu \bar{w}_k^\nu \right. \\ &\quad \left. + d\eta_\mu \wedge d\xi_\nu \sum_{k=1}^n w_k^\mu \bar{z}_k^\nu + d\eta_\mu \wedge d\eta_\nu \sum_{k=1}^n w_k^\mu \bar{w}_k^\nu \right\}.\end{aligned}$$

REMARK. The part of the theorem that asserts that in the case of a complex manifold the form  $\frac{1}{m!}\varphi_0^m$  gives its volume can be proved rather simply. In fact, the form  $\varphi_0$  is invariant relative to unitary transformations of  $\mathbb{C}^n$ , since for unitary matrices  $U^*U = E$ , and hence  $U'\bar{U} = E$ , and hence, if  $dw = Udz$ , then

$$\begin{aligned} \sum_{\nu=1}^n dw_\nu \wedge d\bar{w}_\nu &= (dw)'\wedge d\bar{w} = (dz)'\wedge U' \wedge Ud\bar{z} \\ &= (dz)'\wedge d\bar{z} = \sum_{\nu=1}^n dz_\nu d\bar{z}_\nu. \end{aligned} \tag{16}$$

Therefore, in the case of a complex  $m$ -dimensional manifold  $M$  we may assume that  $T_z(M) = T$  coincides with the plane of the variables  $(z_1, \dots, z_m)$ . Then

$$\varphi_0|_T = \frac{i}{2} \sum_{\nu=1}^m dz_\nu \wedge d\bar{z}_\nu$$

and

$$\begin{aligned} \frac{1}{m!}\varphi_0^m|_T &= \left(\frac{i}{2}\right)^m dz_1 \wedge d\bar{z}_1 \wedge \dots \wedge dz_m \wedge d\bar{z}_m \\ &= dx_1 \wedge dy_1 \wedge \dots \wedge dx_m \wedge dy_m \end{aligned}$$

(we have again used the fact that  $dz_\mu \wedge d\bar{z}_\mu = -2id x_\mu \wedge dy_\mu$ ). The right-hand side here is the volume element of the plane  $T$  and the equality in (12) is proved.

Wirtinger's theorem has an interesting geometric consequence, which does not happen for real manifolds. It is based on the fact that the form giving the volume of complex manifolds has the form

$$\frac{1}{m!}\varphi_0^m = \sum_J \left(\frac{i}{2}\right)^m dz_{j_1} \wedge d\bar{z}_{j_1} \wedge \dots \wedge dz_{j_m} \wedge d\bar{z}_{j_m}, \tag{17}$$

where the sum is taken over all ordered  $(j_1 < \dots < j_m)$  subsets  $J$  of the numbers  $1, 2, \dots, n$ . Since  $\frac{i}{2}dz_j \wedge d\bar{z}_j = dx_j \wedge dy_j$ , then the integral over  $M$  of the term of this sum with index  $J = (j_1, \dots, j_m)$  gives the volume of the projection of  $M$  onto the  $(z_{j_1}, \dots, z_{j_m})$  coordinate plane (including multiplicities if under such a projection several points of  $M$  go into a single point of the plane). Therefore, we have

COROLLARY. *The volume of a complex manifold  $M$  of dimension  $m$  is equal to the sum of the volumes of its projections onto the  $m$ -dimensional coordinate planes  $(z_{j_1}, \dots, z_{j_m})$ , where  $j_1, \dots, j_m$  are ordered sets of the numbers  $1, \dots, n$ .*

In particular, the area of a complex curve ( $m = 1$ ) is equal to the sum of its projections onto the  $z_j$  coordinate axes.

From Wirtinger's theorem we also get an important minimal property of complex manifolds.



**THEOREM 2.** *Suppose that the cycle  $\Gamma$  is the boundary of a compact  $m$ -dimensional complex manifold  $M \subset \mathbb{C}^n$ . Then  $M$  has the smallest volume among all the real  $(2m)$ -dimensional submanifolds of  $\mathbb{C}^n$  with boundary  $\Gamma$ .*

◀ By the definition of the form  $\varphi_0$  and the rules of differentiation (taking into account that  $d\varphi_0 \equiv 0$ )

$$d(d^c|z|^2 \wedge \varphi_0^{m-1}) = dd^c|z|^2 \wedge \varphi_0^{m-1} = \varphi_0^m.$$

Therefore, for any real  $(2m)$ -dimensional submanifold  $N \subset \mathbb{C}^n$  with boundary  $\Gamma$  by Wirtinger's theorem and Stokes's formula we have

$$\text{Vol } N \geq \frac{1}{m!} \int_N \varphi_0^m = \frac{1}{m!} \int_\Gamma d^c|z|^2 \wedge \varphi_0^{m-1}.$$

On the other hand, by the same argument,

$$\frac{1}{m!} \int_\Gamma d^c|z|^2 \wedge \varphi_0^{m-1} = \frac{1}{m!} \int_M \varphi_0^m = \text{Vol } M. \blacktriangleright$$

We remark that not every cycle of real dimension  $2m - 1$  can bound a complex manifold: for example, for  $m > 1$  it must be a maximally complex manifold (see subsection 17).

**19. The Fubini-Study form and related topics.** The metric form of the natural metric of complex projective space  $\mathbb{P}^n$  (the Fubini-Study form) has the form

$$ds^2 = \frac{(w, w)(dw, dw) - (w, dw)(dw, w)}{(w, w)^2}, \quad (1)$$

where  $w = (w_0, \dots, w_n)$  are homogeneous coordinates, and the parentheses denote the Hermitian product (cf. formula (18) of subsection 1). To it corresponds the differential form

$$\omega = \frac{i}{2} \left( \frac{1}{|w|^2} \sum_{\nu=0}^n dw_\nu \wedge d\bar{w}_\nu - \frac{1}{|w|^4} \sum_{\nu=0}^n \bar{w}_\nu dw_\nu \wedge \sum_{\nu=0}^n w_\nu d\bar{w}_\nu \right),$$

which can be rewritten as

$$\omega = \frac{dd^c|w|^2}{|w|^2} - \frac{d|w|^2 \wedge d^c|w|^2}{|w|^4} = dd^c \ln|w|^2 \quad (2)$$

(the last equality is verified by a direct calculation).

Since for  $w_0 \neq 0$  the function  $\ln|w_0|^2 = \ln w_0 + \ln \bar{w}_0$  is harmonic, then  $dd^c \ln|w_0|^2 = \frac{i}{2} \partial \bar{\partial} \ln|w_0|^2 = 0$ , and hence, for  $w_0 \neq 0$

$$dd^c \ln|w|^2 = dd^c \ln \left( 1 + \sum_{\nu=1}^n \left| \frac{w_\nu}{w_0} \right|^2 \right).$$

Thus, in local coordinates  $z_\nu = w_\nu/w_0$  of the affine part of  $\mathbb{P}^n$ , i.e., in the domain  $U_0 = \mathbb{C}^n$  of its standard covering,

$$\omega = dd^c \ln(1 + |z|^2). \quad (3)$$

In particular, for  $n = 1$  this formula takes the form

$$\omega = \frac{i}{2} \partial \bar{\partial} \ln(1 + z\bar{z}) = \frac{i}{2} \frac{dz \wedge d\bar{z}}{(1 + |z|^2)^2}, \quad (4)$$

and  $\omega$  coincides with the form associated to the spherical metric on  $\mathbb{C}$ : the Fubini-Study metric is a higher-dimensional generalization of the latter.

**THEOREM 1.** *The volume of the projective space  $\mathbb{P}^n$  in the Fubini-Study metric is equal to*

$$\int_{\mathbb{P}^n} \omega^n = \pi^n. \quad (5)$$

◀ Since the set of points at infinity of  $\mathbb{P}^n$  has real codimension 2 and does not affect the integral, then instead of  $\mathbb{P}^n$  we can integrate over  $\mathbb{C}^n$  and represent  $\omega$  there by formula (3). In particular, for  $n = 1$ , introducing polar coordinates ( $z = re^{i\theta}$ ) on  $\mathbb{C}$ , we will obtain

$$\int_{\mathbb{P}} \omega = \frac{i}{2} \int_{\mathbb{C}} \frac{dz \wedge d\bar{z}}{(1 + |z|^2)^2} = \int_0^{2\pi} d\theta \int_0^\infty \frac{r dr}{(1 + r^2)^2} = \pi. \quad (6)$$

In the case of arbitrary  $n$ , rewriting (3) in the form

$$\omega = \frac{i}{2} \left( \frac{\sum dz_\nu \wedge d\bar{z}_\nu}{1 + |z|^2} - \frac{\sum \bar{z}_\nu dz_\nu \wedge \sum z_\nu d\bar{z}_\nu}{(1 + |z|^2)^2} \right)$$

(cf. (2)) and remarking that the exterior powers of the odd forms  $\sum \bar{z}_\nu dz_\nu$  and  $\sum z_\nu d\bar{z}_\nu$  are equal to 0, after simple calculations we find

$$\begin{aligned} \omega^n &= \left(\frac{i}{2}\right)^n \left\{ \frac{n!}{(1 + |z|^2)^n} \prod_{\nu=1}^n dz_\nu \wedge d\bar{z}_\nu \right. \\ &\quad - \frac{(n-1)!n}{(1 + |z|^2)^{n+1}} \sum_{\nu=1}^n dz_1 \wedge d\bar{z}_1 \wedge \cdots \wedge dz_{\nu-1} \wedge d\bar{z}_{\nu-1} \\ &\quad \quad \quad \wedge dz_{\nu+1} \wedge d\bar{z}_{\nu+1} \wedge \cdots \wedge dz_n \wedge d\bar{z}_n \\ &\quad \quad \quad \left. \wedge \sum_{\mu, \nu=1}^n \bar{z}_\mu z_\nu dz_\mu \wedge d\bar{z}_\nu \right\} \\ &= \left(\frac{i}{2}\right)^n \frac{n!}{(1 + |z|^2)^{n+1}} \prod_{\nu=1}^n dz_\nu \wedge d\bar{z}_\nu. \end{aligned} \quad (7)$$

We set  $'z = (z_1, \dots, z_{n-1})$ ,  $z_n = re^{i\theta}$ , and integrate first over  $z_n$  for fixed  $'z$ :

$$\begin{aligned} \int_{\mathbb{C}^n} \omega^n &= \int_{\mathbb{C}^{n-1}} \left(\frac{i}{2}\right)^{n-1} n! \prod_{\nu=1}^{n-1} dz_\nu \wedge d\bar{z}_\nu \int_0^{2\pi} d\theta \int_0^\infty \frac{r dr}{(1 + |'z|^2 + r^2)^{n+1}} \\ &= \pi \int_{\mathbb{C}^{n-1}} \left(\frac{i}{2}\right)^{n-1} \frac{(n-1)!}{(1 + |'z|^2)^n} \sum_{\nu=1}^{n-1} dz_\nu \wedge d\bar{z}_\nu. \end{aligned}$$

Considering (7), we remark that the integral obtained on the right-hand side is different from the original integral in the left-hand side by replacing  $n$  by  $n - 1$ . Therefore, repeating the same step, we can lower the degree until we reach the integral calculated in (6):

$$\int_{\mathbb{C}^n} \omega^n = \pi^{n-1} \int_{\mathbb{C}} \frac{i}{2} \frac{dz_1 \wedge d\bar{z}_1}{(1 + |z_1|^2)^2} = \pi^n. \blacktriangleright$$

Using this result we can introduce in a natural way the *normalized* Fubini-Study form  $\tilde{\omega} = \frac{1}{\pi} \omega$ : the volume of  $\mathbb{P}^n$  measured using it is equal to 1.

In  $\mathbb{C}^n$  we consider the form

$$\omega_0 = \frac{1}{\pi} dd^c \ln |z|^2 = \frac{1}{\pi} \left( \frac{\varphi_0}{|z|^2} - \frac{d|z|^2 \wedge d^c |z|^2}{|z|^4} \right), \quad (8)$$

which in contrast to  $\omega$  has a singularity at the point  $z = 0$ . If we let  $z = (z_1, \dots, z_n)$  be homogeneous coordinates in  $\mathbb{P}^{n-1}$ , then  $\omega_0$  will be the (normalized) Fubini-Study form of  $\mathbb{P}^{n-1}$ . Therefore, the form  $\omega_0$  actually depends on  $n - 1$  variables, not on  $n$  (for example, for  $z_1 \neq 0$  it depends on the ratios  $z_2/z_1, \dots, z_n/z_1$ ; this, as above, follows from the fact that  $dd^c \ln |z_1|^2 = 0$  for  $z_1 \neq 0$ ) and hence, its exterior power  $\omega_0^n \equiv 0$  for  $z \neq 0$  as a form of bidegree  $(n, n)$ , depending on  $n - 1$  variables.

We shall show that the form  $\omega_0$  measures the *volume density* of complex manifolds in  $\mathbb{C}^n$ , i.e., the ratio of the Euclidean volume of the portion of the manifold in the ball of radius  $r$  to the volume of the ball with the same radius and dimension equal to the dimension of the manifold.

**THEOREM 2.** *Let  $M \subset \mathbb{C}^n$  be a complex manifold of dimension  $m < n$ , not containing the point  $z = 0$ , and let  $B_r = \{z \in \mathbb{C}^n : |z| < r\}$  be a ball. Then*

$$\int_{M \cap B_r} \omega_0^m = \frac{\text{Vol}(M \cap B_r)}{V_m(r)}, \quad (9)$$

where  $V_m(r) = \pi^m r^{2m} / m!$  is the volume of a complex  $m$ -dimensional ball of radius  $r$ .

◀ Since  $M$  does not contain 0, the form in the integrand in the left-hand side does not have singularities and we can apply Stokes's formula:

$$\int_{M \cap B_r} \omega_0^m = \frac{1}{\pi} \int_{M \cap B_r} d(d^c \ln |z|^2 \wedge \omega_0^{m-1}) = \frac{1}{\pi} \int_{M \cap S_r} d^c \ln |z|^2 \wedge \omega_0^{m-1},$$

where  $S_r = \partial B_r$  is a sphere. Since  $d|z|^2 = 0$  on this sphere, by formula (8)  $\omega_0 = \varphi_0 / \pi r^2$  on it, and since  $d^c \ln |z|^2 = d^c |z|^2 / |z|^2$ , then

$$\int_{M \cap B_r} \omega_0^m = \frac{1}{\pi^m r^{2m}} \int_{M \cap S_r} d^c |z|^2 \wedge \varphi_0^{m-1}.$$

Again applying Stokes's formula to the integral on the right-hand side, and then applying Wirtinger's theorem, we will find

$$\int_{M \cap S_r} d^c |z|^2 \wedge \varphi_0^{m-1} = \int_{M \cap B_r} \varphi_0^m = m! \text{Vol}(M \cap B_r)$$

and, substituting this in the preceding formula, we obtain (9). ►

The last form that we introduce here is a form of degree  $2n - 1$  in  $\mathbb{C}^n$ :

$$\sigma_0 = \frac{1}{\pi} d^c \ln |z|^2 \wedge \omega_0^{n-1}. \quad (10)$$

Like  $\omega_0$ , it has a singularity at  $z = 0$ , and for  $z \neq 0$  its differential  $d\sigma_0 = \omega_0^n = 0$ , so that it is closed in  $\mathbb{C}^n \setminus \{0\}$ . For  $n = 1$ , setting  $z = re^{i\theta}$ , we find that

$$\sigma_0 = \frac{1}{\pi} d^c \ln |z|^2 = \frac{d\theta}{2\pi}, \quad (11)$$

i.e., it coincides with the form using which one calculates the index of a closed path  $\gamma \subset \mathbb{C} \setminus \{0\}$  relative to the point  $z = 0$ . We shall show that this form plays an analogous role for any  $n$ .

Consider a  $(2n - 1)$ -dimensional cycle in  $\mathbb{C}^n \setminus \{0\}$ , i.e., a closed (without boundary) real hypersurface in  $\mathbb{C}^n$ , not containing the point  $z = 0$ . It is known that the  $(2n - 1)$ st homology group  $H_{2n-1}(\mathbb{C}^n \setminus \{0\}, \mathbb{Z}) = 0$ , i.e., that each such cycle  $\gamma$  is homologous in  $\mathbb{C}^n \setminus \{0\}$  to some integer multiple of the sphere  $S_r = \{|z| = r\}$ . This integer is called the *index of the cycle  $\gamma$  relative to the point  $z = 0$* .

For  $n = 1$  the index of a closed path  $\gamma$  (the number of times it winds around  $z = 0$ ) is equal to the integral along  $\gamma$  of the form  $\sigma_0 = d\theta/(2\pi)$ . The analogous result also holds for arbitrary  $n$ .

**THEOREM 3.** *The index of a  $(2n - 1)$ -dimensional cycle  $\gamma \subset \mathbb{C}^n \setminus \{0\}$  relative to the point  $z = 0$  is*

$$\text{ind}_0 \gamma = \int_{\gamma} \sigma_0. \quad (12)$$

◀ By definition  $\text{ind}_0 \gamma$  is equal to the integer  $k$  such that  $\gamma$  is homologous to  $kS_r$  in  $\mathbb{C}^n \setminus \{0\}$ , i.e.,  $\gamma - kS_r$  is the boundary of a  $(2n)$ -dimensional chain  $\Gamma \subset \mathbb{C}^n \setminus \{0\}$ . Since the form  $\sigma_0$  is closed in  $\mathbb{C} \setminus \{0\}$ , by Stokes's formula

$$\int_{\gamma} \sigma_0 - k \int_{S_r} \sigma_0 = \int_{\Gamma} d\sigma_0 = 0 \quad (13)$$

and it remains to compute

$$\int_{S_r} \sigma_0 = \frac{1}{\pi} \int_{S_r} d^c \ln |z|^2 \wedge \omega_0^{n-1}.$$

Stokes's formula cannot be applied here because the form in the integrand has a singularity at  $z = 0$ , but acting as in the proof of the preceding theorem, we will obtain that

$$\int_{S_r} \sigma_0 = \frac{1}{\pi^n r^{2n}} \int_{S_r} d^c |z|^2 \wedge \varphi_0^{n-1} = \frac{1}{\pi^n r^{2n}} \int_{B_r} \varphi_0^n$$

(now Stokes's formula can be applied). By Wirtinger's theorem the integral on the right-hand side is equal to  $n! \text{Vol } B_r = \pi^n r^{2n}$ , so that the integral being calculated is equal to 1 and from (13) it follows that

$$\int_\gamma \sigma_0 = k \int_{S_r} \sigma_0 = k = \text{ind}_0 \gamma. \blacktriangleright$$

The concept of index goes back to Henri Poincaré, so that it is natural to call the form introduced in (10) the *Poincaré form*.

§7. Coverings

**20. The concept of a covering.** This concept appeared as a result of a topological generalization of the concept of a Riemann surface (see subsection 33 of Part I) and plays an important role in the study of mappings that are not one-to-one.

**DEFINITION.** The triple of objects  $X$ ,  $M$ , and  $\pi$ , where  $X$  and  $M$  are arcwise connected Hausdorff topological spaces, and  $\pi: X \rightarrow M$  is a continuous mapping, is called a *covering* if for any point  $p \in M$  there exists a neighborhood  $U \subset M$  such that  $\pi^{-1}(U)$  is homeomorphic to the product of  $U$  and some discrete space  $E$ , and if  $h: \pi^{-1}(U) \rightarrow U \times E$  is this homeomorphism and  $\pi': (p, \varepsilon) \rightarrow p$  is the usual projection, then the diagram pictured in Figure 20 is commutative, i.e., for any  $x \in \pi^{-1}(U)$ ,

$$\pi' \circ h(x) = \pi(x). \tag{1}$$

The space  $X$  is called a *covering space* or simply a *covering*,  $M$  is the *base*, and  $\pi$  is the *projection*; the inverse images  $\pi^{-1}(p)$  of points  $p \in M$  are called *stalks* or *fibers*. The commutativity of the diagram means that the homeomorphism  $h$  preserves stalks: for any  $x \in \pi^{-1}(p)$  we have  $\pi' \circ h(x) = p$ , i.e., for all such  $x$  the first coordinate of  $h(x) = (p, \varepsilon)$  is the same and is equal to  $p$  (see Figure 20).

It follows from the definition of a covering that the open set  $\pi^{-1}(U)$  splits into a union of disjoint open sets  $\tilde{U}_\varepsilon = h^{-1}(U \times \varepsilon)$ ,  $\varepsilon \in E$ , which are called *liftings* of the neighborhood  $U$ . The restrictions  $\pi|_{\tilde{U}_\varepsilon}$  are homeomorphisms, and for any covering the projection  $\pi: X \rightarrow M$  is locally a homeomorphism.

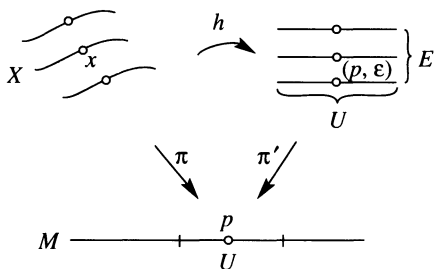

FIGURE 20

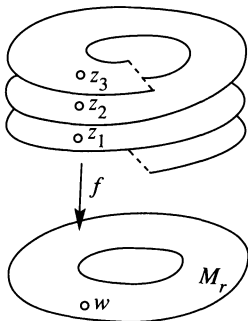

FIGURE 21

If  $X$  and  $M$  are complex manifolds, and  $\pi: X \rightarrow M$  is a holomorphic mapping, then the covering is said to be *holomorphic*.

Simple examples of holomorphic coverings of domains of the plane are given elementary functions of one complex variable. Thus,  $f(z) = z^m$  for a natural number  $m$  defines a covering  $f: X_r \rightarrow M_r$  of the annulus  $M_r = \{r < |w| < 1/r\}$  by the annulus

$$X_r = \{ \sqrt[m]{r} < |z| < 1/\sqrt[m]{r} \};$$

the stalks  $f^{-1}(w)$  of this covering consist of  $m$  points, the  $m$ th roots of  $w$ . Analogously, the function  $f(z) = e^z$  defines a covering of the same annulus  $M_r$  by the strip  $\{\ln r < \operatorname{Re} w < \ln 1/r\}$ , the stalks  $f^{-1}(w)$  of which consist of a countable set of values of  $\operatorname{Ln} w = \ln w + 2k\pi i$  ( $k = 0, \pm 1, \dots$ ).

Figure 21 shows how we can represent these coverings geometrically by using Riemann surfaces. In the case of the function  $f(z) = z^m$  we also need to identify the ends of the band on the Riemann surface (they are shown by a dashed line), and in the case of  $f(z) = e^z$  we need to represent the band as winding unboundedly in both directions. In this representation the mapping  $f$  reduces to the usual projection.

As  $r \rightarrow 0$  the first example gives a covering  $f: \mathbb{C}_* \rightarrow \mathbb{C}_*$ , where  $\mathbb{C}_* = \mathbb{C} \setminus \{0\}$ , and the second gives  $\mathbb{C} \rightarrow \mathbb{C}_*$ , and the stalks of the first of these are finite sets, while those of the second are countable. We shall consider examples of coverings related to holomorphic functions of several complex variables in the following chapter.

We now take up the question of the liftability of paths to coverings, and for simplicity we will say that all the paths are parameterized by the interval  $I = [0, 1]$ . A path  $\gamma: I \rightarrow M$  is said to be *liftable* to the covering  $\pi: X \rightarrow M$  if there exists a path  $\tilde{\gamma}: I \rightarrow X$  such that  $\pi \circ \tilde{\gamma} = \gamma$  (then we say that  $\tilde{\gamma}$  is the *lifting* of  $\gamma$  and that  $\gamma$  is the *projection* of  $\tilde{\gamma}$ ).

**THEOREM 1.** *For any covering  $\pi: X \rightarrow M$  any path  $\gamma: I \rightarrow M$  can be lifted to a path  $\tilde{\gamma}: I \rightarrow X$  and moreover this can be done uniquely for a given starting point  $\tilde{\gamma}(0)$ .*

◀ *Uniqueness.* Two liftings  $\tilde{\gamma}_1$  and  $\tilde{\gamma}_2$  either do not intersect or they coincide. In fact, the set  $E = \{t \in I : \tilde{\gamma}_1(t) = \tilde{\gamma}_2(t)\}$  is open in  $I$ , since  $\pi \circ \tilde{\gamma}_1(t) \equiv \pi \circ \tilde{\gamma}_2(t)$ , and  $\pi$  is a local homeomorphism. But it is also closed, since  $E' = I \setminus E$  is open: for  $t_0 \in E'$  the point  $\tilde{\gamma}_1(t_0) \neq \tilde{\gamma}_2(t_0)$ , and since  $X$  is Hausdorff there exist disjoint neighborhoods  $\tilde{U}' \ni \tilde{\gamma}_1(t_0)$  and  $\tilde{U}'' \ni \tilde{\gamma}_2(t_0)$ , which are projected to the same neighborhood  $U$ , and hence  $\tilde{\gamma}_1(t) \neq \tilde{\gamma}_2(t)$  in some neighborhood of  $t_0$ . Thus,  $E$  either coincides with  $I$  or is empty.

*Existence.* The local liftability of  $\gamma$  is ensured by the definition of a covering, since for each point  $\gamma(t_0)$  there exists a neighborhood  $U$  such that  $\pi^{-1}(U)$  splits into open sets on which  $\pi$  is a homeomorphism. Since  $\gamma(I)$  is compact, it can be covered by a finite number of neighborhoods on  $M$ , in each of which lifting is possible, and it remains only to paste together a finite number of segments of paths. ►

**COROLLARY.** *All the stalks  $\pi^{-1}(p)$ ,  $p \in M$ , of a covering  $\pi: X \rightarrow M$  have the same cardinality.*

◄ Let  $p, q \in M$  and let  $\gamma: I \rightarrow M$  be a path from  $p$  to  $q$  (it exists since  $M$  is arcwise connected). We construct a mapping  $\varphi: \pi^{-1}(p) \rightarrow \pi^{-1}(q)$ , which relates to each point  $x \in \pi^{-1}(p)$  the endpoint  $y = \tilde{\gamma}_x(1)$  of the lifting of  $\gamma$  starting at  $x$  (this lifting is uniquely determined by Theorem 1). The mapping  $\varphi$  is injective (one-to-one) by Theorem 1. But it is also surjective (onto  $\pi^{-1}(q)$ ), since for any point  $y_0 \in \pi^{-1}(q)$  Theorem 1 allows us to construct a unique lifting of the path  $\gamma^{-1}(t) = \gamma(1-t)$  (from  $q$  to  $p$ ) starting at  $y_0$ ; if  $x$  is the endpoint of this lifting, then  $\tilde{\gamma}_x(1) = y_0$ . Thus, the sets  $\pi^{-1}(p)$  and  $\pi^{-1}(q)$  have the same cardinality. ►

The cardinality of any stalk  $\pi^{-1}(p)$  is called the *multiplicity* of the covering  $\pi: X \rightarrow M$ .

We recall that two paths  $\gamma_0$  and  $\gamma_1: I \rightarrow M$  with common endpoints  $p, q$  are said to be *homotopic* in  $M$  if there exists a continuous mapping  $\gamma: I \times I \rightarrow M$  such that  $\gamma(0, t) = \gamma_0(t)$ ,  $\gamma(1, t) = \gamma_1(t)$  for all  $t \in I$ , and  $\gamma(s, 0) = p$ ,  $\gamma(s, 1) = q$  for all  $s \in I$  (see subsection 17 of Part I).

**THEOREM 2** (concerning monodromy). *If the paths  $\gamma_0$  and  $\gamma_1$  with common endpoints  $p$  and  $q$  are homotopic in  $M$ , then their liftings  $\tilde{\gamma}_0$  and  $\tilde{\gamma}_1$  to the covering  $\pi: X \rightarrow M$  with common starting point  $x$  have a common endpoint and are homotopic in  $X$ .*

◄ Let  $\gamma: I \times I \rightarrow M$  realize the homotopy between  $\gamma_0$  and  $\gamma_1$ . By Theorem 1 for fixed  $s \in I$  the path  $\gamma_s = \gamma(s, t): I \rightarrow M$  lifts uniquely to a path  $\tilde{\gamma}_s = \tilde{\gamma}(s, t)$  with starting point  $x$ . The mapping  $\tilde{\gamma}: (s, t) \rightarrow \tilde{\gamma}(s, t)$  is continuous in  $I \times I$ , since locally  $\tilde{\gamma}(s, t) = \pi^{-1} \circ \gamma(s, t)$ , and  $\pi^{-1}$  and  $\gamma$  are continuous. The function  $\tilde{\gamma}(s, 1)$  is constant on  $I$  as it is a continuous function taking a discrete set of values (from the set  $\pi^{-1}(q)$ ), and hence all the  $\tilde{\gamma}_s$  have a common endpoint. Finally,  $\tilde{\gamma}(0, 1) = \tilde{\gamma}_0(1)$  and  $\tilde{\gamma}(1, t) = \tilde{\gamma}_1(t)$ , i.e.,  $\tilde{\gamma}$  realizes a homotopy between the paths  $\tilde{\gamma}_0$  and  $\tilde{\gamma}_1$  on  $X$ . ►

**COROLLARY.** *If the space  $M$  is simply connected (i.e., any two paths in  $M$  with common endpoints are homotopic), then the multiplicity of any covering  $\pi: X \rightarrow M$  is equal to 1.*

◄ Suppose that some stalk  $\pi^{-1}(q)$  contains two distinct points  $y'$  and  $y''$ . We take a point  $x \in X$  and, using the fact that  $X$  is arcwise connected,

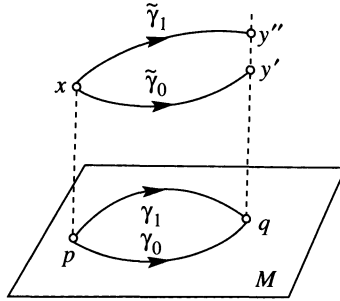

FIGURE 22

we join it by paths  $\tilde{\gamma}_0$  and  $\tilde{\gamma}_1$  respectively to  $y'$  and  $y''$  (Figure 22). Let  $\gamma_0 = \pi \circ \tilde{\gamma}_0$  and  $\gamma_1 = \pi \circ \tilde{\gamma}_1$  be the paths on  $M$  joining the point  $p = \pi(x)$  to  $q = \pi(y') = \pi(y'')$ , and let  $\tilde{\gamma}_0$  and  $\tilde{\gamma}_1$  be their liftings with starting point  $x$ . Since  $M$  is simply connected the paths  $\gamma_0$  and  $\gamma_1$  are homotopic, and then by Theorem 2 the endpoints of their liftings  $y' = \tilde{\gamma}_0(1)$  and  $y'' = \tilde{\gamma}_1(1)$  coincide. This is a contradiction since we assumed that  $y' \neq y''$ . ►

If the image  $M = \pi(X)$  of a covering  $\pi: X \rightarrow M$  is simply connected, then, by this corollary, the inverse function  $\pi^{-1}(p)$  is defined in  $M$ . Consequently, it generalizes the classical monodromy theorem (Part I, subsection 28).

**21. Fundamental groups and coverings.** We will use the symbol  $\sim$  to denote homotopy of paths, and  $M$  is assumed to be an arcwise connected Hausdorff space. We recall some definitions: the *product of two paths*  $\alpha$  and  $\beta: I \rightarrow M$ , for which  $\alpha(1) = \beta(0)$ , is the path

$$\alpha\beta(t) = \begin{cases} \alpha(2t), & t \in [0, 1/2], \\ \beta(2t - 1), & t \in [1/2, 1]; \end{cases} \tag{1}$$

the *point path* is the path  $\varepsilon(t) = \text{const}$ , and the *inverse* to the path  $\alpha$  is the path  $\alpha^{-1}(t) = \alpha(1 - t)$ .

Fix a point  $p \in M$  and consider the set of all closed paths (*loops*) on  $M$ , whose starting and end points are equal to  $p$ . Homotopy of loops is an equivalence relation, and we can partition these loops into equivalence classes according to this equivalence relation; these classes are called *homotopy classes*. The equivalence class containing the loop  $\alpha$  is denoted  $\alpha$ .

The *product* of the classes  $\alpha$  and  $\beta$  is the class  $\alpha\beta$  containing the product<sup>(29)</sup>  $\alpha\beta$  of any representatives of these classes ( $\alpha \in \alpha, \beta \in \beta$ ). This notion is well defined, i.e., it does not depend on the choice of representatives, since if  $\alpha_0 \sim \alpha_1$  and  $\beta_0 \sim \beta_1$ , then  $\alpha_0\beta_0 \sim \alpha_1\beta_1$ : the homotopy

<sup>(29)</sup> Any loops which begin and end at  $p$  can be multiplied.



between the loops  $\alpha_0\beta_0$  and  $\alpha_1\beta_1$  is obviously realized by the function

$$\gamma(s, t) = \begin{cases} \alpha(s, 2t), & t \in [0, 1/2], s \in I, \\ \beta(s, 2t - 1), & t \in [1/2, 1], s \in I, \end{cases}$$

where  $\alpha(s, t)$  and  $\beta(s, t)$  are functions that realize the homotopies  $\alpha_0 \sim \alpha_1$  and  $\beta_0 \sim \beta_1$ .

**THEOREM 1.** *The set  $\pi_1(M, p)$  of homotopy classes of loops on  $M$  which start and end at the point  $p$  forms a group under the operation of multiplication of classes.*

◀ We denote by  $e$  the class of loops that are homotopic to zero (i.e., homotopic to the point loop  $\varepsilon(t) = p$ ). For any class  $\alpha \in \pi_1(M, p)$  the product  $\alpha e = \alpha$ , since if  $\alpha \in \alpha$ , then the product  $\alpha\varepsilon \sim \alpha$ . In fact, by the definition of the product of paths (1) we have

$$\alpha\varepsilon(t) = \begin{cases} \alpha(2t), & t \in [0, 1/2], \\ \alpha(1) = p, & t \in [1/2, 1], \end{cases}$$

and the homotopy between this path and the path  $\alpha$  is realized by the function  $\gamma(s, t) = \alpha[st + (1-s)\tau(t)]$ , where  $\tau(t) = 2t$  for  $t \in [0, 1/2]$  and  $\tau(t) = 1$  for  $t \in [1/2, 1]$ . Thus  $e$  is a neutral (identity) element of  $\pi_1(M, p)$ .

Moreover, for a class  $\alpha \in \pi_1(M, p)$  we denote by  $\alpha^{-1}$  the class of loops that are homotopic to some loop  $\alpha^{-1}$ , where  $\alpha \in \alpha$ ; this is well defined notation, since  $\alpha \sim \beta \Rightarrow \alpha^{-1} \sim \beta^{-1}$  (if  $\gamma(s, t)$  realizes the first homotopy, then  $\gamma(s, 1-t)$  will realize the second). Then  $\alpha\alpha^{-1} = e$  for any  $\alpha \in \pi_1(M, p)$ , since for  $\alpha \in \alpha$  by definition (1) we have

$$\alpha\alpha^{-1}(t) = \begin{cases} \alpha(2t), & t \in [0, 1/2], \\ \alpha^{-1}(2t - 1) = \alpha[2(1-t)], & t \in [1/2, 1], \end{cases}$$

and the function

$$\gamma(s, t) = \begin{cases} \alpha[2(1-s)t], & t \in [0, 1/2], s \in I, \\ \alpha[2(1-s)(1-t)], & t \in [1/2, 1], s \in I, \end{cases}$$

realizes the homotopy between  $\alpha\alpha^{-1}$  and the point path  $\alpha(t) = \alpha(0)$ .

Finally, multiplication of classes is associative ( $\alpha \cdot \beta\gamma = \alpha\beta \cdot \gamma$ ), since the products of loops

$$\alpha \cdot \beta\gamma(t) = \begin{cases} \alpha(2t), & t \in [0, 1/2], \\ \beta(4t - 2), & t \in [1/2, 3/4], \\ \gamma(4t - 3), & t \in [3/4, 1], \end{cases}$$

$$\alpha\beta \cdot \gamma(t) = \begin{cases} \alpha(4t), & t \in [0, 1/4], \\ \beta(4t - 1), & t \in [1/4, 1/2], \\ \gamma(2t - 1), & t \in [1/2, 1], \end{cases}$$

are homotopic: if we write  $\alpha \cdot \beta \gamma(t) = \delta(t)$ , then  $\alpha \beta \cdot \gamma(t) = \delta \circ \tau(t)$ , where  $\tau(t)$  is equal to  $2t$  for  $t \in [0, 1/4]$ , to  $t + 1/4$  for  $t \in [1/4, 1/2]$ , and to  $(t+1)/2$  for  $t \in [1/2, 1]$ , and hence, the function  $\delta[(1-s)t + s\tau(t)]$  realizes the homotopy between these loops. ►

**DEFINITION.** The group  $\pi_1(M, p)$  is called the *fundamental group* of the topological space  $M$  with base point  $p$ .

**THEOREM 2.** *The fundamental groups  $\pi_1(M, p)$  for distinct points  $p \in M$  are isomorphic.*

◀ Let  $p$  and  $q$  be arbitrary points of  $M$ ; since  $M$  is arcwise connected there exists a path  $\gamma: I \rightarrow M$  from  $p$  to  $q$ . For each class  $\alpha \in \pi_1(M, p)$  there is a corresponding class  $\beta \in \pi_1(M, q)$ , containing the loop  $\beta = \gamma^{-1} \alpha \gamma$ , where  $\alpha \in \alpha$ . We leave it to the reader to prove that the mapping  $\varphi: \alpha \rightarrow \beta$  is an isomorphism of the group  $\pi_1(M, p)$  onto  $\pi_1(M, q)$ .

►

Thus, for a space  $M$  the fundamental group  $\pi_1(M)$  is defined up to isomorphism.

**EXAMPLES.**

1. We compute the fundamental group of the circle  $S^1 = \{|z| = 1\}$  with base point 1. On  $S^1$  there is a set of loops  $\alpha_m: t \rightarrow e^{2\pi imt}$ , where  $t \in I$  and  $m$  is an integer; for different  $m$  these loops are not homotopic. An arbitrary loop  $\alpha$  (up to multiplication by a point loop) has the form  $t \rightarrow e^{if(t)}$ , where  $f$  is a continuous real function,  $f(0) = 0$ ,  $f(1) = 2\pi m$  ( $m$  is an integer), and is homotopic to the loop  $\alpha_m$ ; the homotopy is realized by the function  $\gamma(s, t) = e^{i[(1-s)f(t) + 2\pi mst]}$ . Finally,  $\alpha_m \alpha_n \sim \alpha_{m+n}$ , so that  $\pi_1(S^1)$  is isomorphic to the group  $\mathbb{Z}$  of integers. Any annulus  $\{r < |z| < R\}$  and the punctured plane  $\mathbb{C}_* = \mathbb{C} \setminus \{0\}$  have the same fundamental group.

2. For spheres  $S^n$  of dimension  $n > 1$  the fundamental group  $\pi_1(S^n) = 0$ , since these spheres are simply connected (any loop on them is homotopic to zero).

Let  $f: M \rightarrow N$  be a continuous mapping of topological spaces. Then to any path  $\gamma: I \rightarrow M$  there is a corresponding path  $f(\gamma) = f \circ \gamma: I \rightarrow N$ , where loops go to loops and homotopy is preserved:  $\gamma_0 \sim \gamma_1 \Rightarrow f(\gamma_0) \sim f(\gamma_1)$  (the homotopy between these last two loops is realized by the function  $f \circ \gamma(s, t)$ , where  $\gamma$  realizes the homotopy  $\gamma_0 \sim \gamma_1$ ). Thus,  $f$  induces a mapping of fundamental groups

$$f_*: \pi_1(M, p) \rightarrow \pi_1(N, f(p)), \quad (2)$$

which is a homomorphism since  $f(\alpha\beta) = f(\alpha)f(\beta)$ .

If  $f: M \rightarrow N$  is a homeomorphism onto  $N$ , then  $f_*$  is an isomorphism, so that their fundamental groups' being isomorphic is necessary for spaces to be homeomorphic. This condition is obviously not sufficient: an annulus on the plane has the same fundamental group as the circle, but they are not homeomorphic.

Suppose the spaces  $X$  and  $M$  are locally simply connected (i.e., for each point there is a simply connected neighborhood) and let  $\pi: X \rightarrow M$  be a covering. The induced homomorphism of fundamental groups

$$\pi_*: \pi_1(X) \rightarrow \pi_1(M) \quad (3)$$

maps the homotopy class  $\tilde{\alpha} \in \pi_1(X)$  to the class containing the projection  $\alpha = \pi \circ \tilde{\alpha}$  of a loop  $\tilde{\alpha} \in \tilde{\alpha}$ . The homomorphism  $\pi_*$  is a monomorphism (i.e., maps different elements of  $\pi_1(X)$  to different elements): in fact, it suffices to prove that the inverse image of the neutral element  $e \in \pi_1(M)$  is the neutral element of  $\pi_1(X)$ , and this follows from the monodromy theorem of the previous subsection. From this it follows that the image of  $\pi_1(X)$  under the mapping (3),  $\text{im } \pi_* = G$ , is a subgroup of  $\pi_1(M)$  that is isomorphic to  $\pi_1(X)$ .

Modulo the subgroup  $G = \text{im } \pi_*$  we can form *cosets* of loops on  $M$ : two loops  $\alpha$  and  $\beta$  belong to the same coset if  $\alpha\beta^{-1} \in G$ . The coset containing the loop  $\alpha$  will be denoted by the symbol  $[\alpha]$ ; the number of such cosets is called the *index of the subgroup*  $G$ .

EXAMPLE 3. The mapping  $f: \mathbb{C}_* \rightarrow \mathbb{C}_*$  defined by the formula  $f(z) = z^2$  is a two-sheeted covering. Here  $X = M = \mathbb{C}_*$  and  $\pi_1(X) = \pi_1(M) = \mathbb{Z}$  (see the preceding example). We represent the elements of  $\pi_1(M)$  by loops  $\gamma_m: t \rightarrow e^{2\pi imt}$  ( $t \in I, m \in \mathbb{Z}$ ). For odd  $m$  the liftings of  $\gamma_m$  with starting point 1 (the inverse images under the mapping  $f$ , i.e., the paths  $\tilde{\gamma}_m: t \rightarrow e^{\pi imt}$ ) end at the point  $z = -1$  and are not loops. Therefore, the images of the loops representing elements of  $\pi_1(X)$  will only be loops  $\gamma_m$  for even  $m$ . Hence the group  $G = \text{im } f_*$  is isomorphic to the subgroup of even integers. It defines two cosets, representable respectively by the loops  $\gamma_m$  with even or odd  $m$ . The index of  $G$  is equal to 2.

THEOREM 3. *The index of the subgroup  $G = \text{im } \pi_*$  is equal to the multiplicity of the covering  $\pi: X \rightarrow M$ .*

◀ We fix points  $p \in M$ ,  $x \in \pi^{-1}(p)$  and a coset  $[\alpha]$  of loops beginning and ending at  $p$ . Choose a loop  $\alpha \in [\alpha]$ , denote by  $\tilde{\alpha}$  the lifting of  $\alpha$  with starting point  $x$  and we associate to  $[\alpha]$  the point  $\tilde{\alpha}(1) \in \pi^{-1}(p)$ . The theorem follows from the following properties of the mapping  $\varphi: [\alpha] \rightarrow \tilde{\alpha}(1)$ :

(a)  $\varphi$  is well defined, i.e., does not depend on the choice of representative of the coset. In fact, if  $\alpha, \beta \in [\alpha]$ , then  $\alpha\beta^{-1} \in G$ , i.e.,  $\alpha\beta^{-1}$  is the projection of some loop on  $X$ , namely the loop  $\tilde{\alpha}\tilde{\beta}^{-1}$ . From this it follows that  $\tilde{\alpha}(1) = \tilde{\beta}(1)$  (see Figure 23).

(b)  $\varphi$  is injective. In fact, if  $\varphi([\alpha]) = \varphi([\beta])$ , then  $\tilde{\alpha}$  and  $\tilde{\beta}$  have the same endpoints, and then  $\tilde{\alpha}\tilde{\beta}^{-1}$  is a loop and  $\alpha\beta^{-1} \in G$ , i.e.,  $[\alpha] = [\beta]$ .

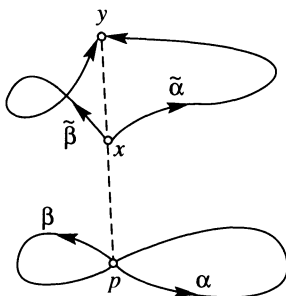

FIGURE 23

(c)  $\varphi$  is surjective. In fact, let  $y \in \pi^{-1}(p)$  be an arbitrary point. We join  $x$  and  $y$  by a path  $\tilde{\alpha}$ ; its projection  $\alpha$  is a loop for which  $\alpha(1) = y$ , i.e.,  $\varphi([\alpha]) = y$ . ►

As a corollary we can again obtain the result of the preceding subsection: coverings over a simply connected base  $M$  have multiplicity one. In fact, here the group  $\pi_1(M)$  is trivial, and hence the index of  $\text{im } \pi_*$  is equal to 1. We remark that in all the cases considered in this book the fundamental group  $\pi_1(M)$  of the base is at most countable, and then by Theorem 3 the cardinality of the stalks of coverings is at most countable (cf. the Poincaré-Volterra theorem from subsection 29 of Part I).

Theorem 3 is interesting because it connects the geometric question of the multiplicity of a covering  $\pi: X \rightarrow M$  with the algebraic question of the index of the subgroup  $\text{im } \pi_*$ . The connection between coverings and subgroups of the fundamental group is best expressed by

**THEOREM 4.** *To any subgroup  $G \subset \pi_1(M)$  there corresponds a covering  $\pi: X \rightarrow M$  for which  $\text{im } \pi_* = G$ .*

◀ *Construction of the covering.* Fix a point  $p_0 \in M$  and consider an arbitrary path  $\alpha: I \rightarrow M$ ,  $\alpha(0) = p_0$ . We divide such paths into equivalence classes modulo the following equivalence relation:  $\alpha \sim \beta \pmod{G}$  if the homotopy class of the loop  $\alpha\beta^{-1}$ , i.e.,  $\alpha\beta^{-1} \in G$  (equivalence modulo  $G$ ). The class containing the path  $\alpha$  is denoted by the symbol  $[\alpha]$  and these classes for all possible paths  $\alpha$ ,  $\alpha(0) = p_0$ , will form the points of the space  $X$ . We define the projection  $\pi: X \rightarrow M$  by the condition  $\pi([\alpha]) = \alpha(1)$ , where  $\alpha$  is an arbitrary representative of the class  $[\alpha]$  (the projection obviously does not depend on the choice of representative).

*Topology in  $X$ .* We define a neighborhood  $\tilde{U}_{[\alpha]}$  of a point  $[\alpha] \in X$  as follows: take the point  $p = \pi([\alpha])$ , a simply connected neighborhood  $U_p \subset M$ , and in it a path  $\beta: I \rightarrow U_p$ ,  $\beta(0) = p$ . The points of  $\tilde{U}_{[\alpha]}$  will be the classes  $[\gamma]$  of paths  $\gamma = \alpha\beta$  for fixed  $\alpha$  and all possible  $\beta$ .

The topology in  $X$  that is introduced by these neighborhoods is Hausdorff. In fact, let  $[\alpha]$  and  $[\alpha']$  be distinct points of  $X$ . If the projections  $p$  and  $p'$  of these points are distinct, we take disjoint neighborhoods  $U_p$  and  $U_{p'}$ , and then  $\tilde{U}_{[\alpha]}$  and  $\tilde{U}_{[\alpha']}$  are also disjoint (the corresponding paths do not even form a loop). But if  $p = p'$ , then  $\alpha'\alpha^{-1} \notin G$ , and then the neighborhoods  $\tilde{U}_{[\alpha]}$  and  $\tilde{U}_{[\alpha']}$ , which project to the same simply connected neighborhood  $U_p$ , are disjoint: otherwise there are paths  $\gamma = \alpha\beta$  and  $\gamma' = \alpha'\beta'$  such that  $\gamma'\gamma^{-1} \in G$ ; but  $\beta$  and  $\beta'$  have the same endpoints and belong to  $U_p$ , hence,  $\beta \sim \beta'$  and  $\gamma'\gamma^{-1} = \alpha'(\beta'\beta^{-1})\alpha^{-1} \sim \alpha'\alpha^{-1}$  (here  $\sim$  denotes homotopy), i.e.,  $\alpha'\alpha^{-1} \in G$ , which is a contradiction.

The space  $X$  is arcwise connected. Suppose  $[\alpha], [\beta] \in X$ ; we choose representatives ( $\alpha$  and  $\beta$ ) from these classes, join the endpoints  $\alpha(1) = p$

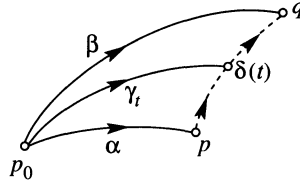

FIGURE 24

and  $\beta(1) = q$  by a path  $\delta: I \rightarrow M$  and denote by  $\gamma_t$  the path on  $M$  joining  $p_0$  and  $\delta(t)$  (see Figure 24;  $M$  is arcwise connected). The mapping  $t \rightarrow [\gamma_t]$  defines a path on  $X$  joining  $[\alpha]$  and  $[\beta]$ .

Obviously, the space  $X$  is locally simply connected, since its neighborhoods  $\tilde{U}_{[\alpha]}$  are homeomorphic to  $U_p$ .

The covering  $\pi: X \rightarrow M$  is the desired one. First of all, it is a covering, since by construction for each point  $p \in M$  there exists a neighborhood  $U$  such that  $\pi^{-1}(U)$  is partitioned into disjoint domains on which  $\pi$  is a homeomorphism. It remains to show that  $\text{im } \pi_* = G$ .

Take a point path  $\varepsilon: I \rightarrow p_0$ , let  $x_0 = [\varepsilon]$ , and consider the fundamental group  $\pi_1(X, x_0)$ . Let  $\tilde{\alpha}$  be an arbitrary element of it (i.e., a homotopy class of loops on  $X$  beginning and ending at  $x_0$ ), and  $\tilde{\alpha} \in \tilde{\alpha}$  a representative of this class. For each fixed  $t \in I$ , according to our construction, the point  $\tilde{\alpha}(t)$  represents a class  $[\alpha_t]$  of paths that are equivalent modulo  $G$  to the path  $\alpha_t(s) = \alpha(st): I \rightarrow M$ ,  $\alpha_t(0) = p_0$ , and the projection  $\pi([\alpha_t]) = \alpha(t)$ . Therefore  $\pi \circ \tilde{\alpha} = \alpha$  is a loop on  $M$  that starts and ends at  $p_0$ , defined up to equivalence modulo  $G$ , and hence  $\pi_*(\tilde{\alpha}) \in G$ .

Conversely, for any element  $\alpha \in G$  (i.e., homotopy class of loops on  $M$ ) we choose a loop  $\alpha \in \alpha$  and lift it to  $X$  with starting point  $x_0$ , setting  $\tilde{\alpha}_t = [\alpha_t]$ . Obviously,  $\pi_*(\tilde{\alpha}) = \alpha$ .  $\blacktriangleright$

Theorem 4 allows us to classify all the coverings with a given base  $M$ : it reduces this question to the study of subgroups of the fundamental group  $\pi_1(M)$ . In particular, from this theorem follows the existence of two “extreme” coverings. One of them corresponds to the fundamental group  $G = \pi_1(M)$  itself; it is trivial (globally homeomorphic), since the index of  $G$  is equal to 1. The other corresponds to the subgroup  $G = \{e\}$ , consisting only of the neutral element, and is called the *universal covering*. Since for it the group  $\text{im } \pi_*$  is trivial and  $\pi_*$  is a monomorphism, its fundamental group  $\pi_1(X)$  is also trivial, i.e., the *universal covering is always simply connected*. The number of its sheets (perhaps infinite) is equal to the number of elements of the group  $\pi_1(M)$ .

EXAMPLES.

1. For the punctured plane  $C_* = C \setminus \{0\}$  the fundamental group is equal to the fundamental group of the circle and is isomorphic to the group of integers  $Z$ . The subgroup of even integers (whose index is equal to 2) corresponds to a two-sheeted covering, the Riemann surface of the function  $w = \sqrt{z}$  with deleted branch points  $z = 0$ ,  $z = \infty$  (see the preceding example). More generally, the subgroup of integers congruent modulo  $m$  corresponds to an  $m$ -sheeted covering of  $C_*$ , the Riemann surface of the function  $w = \sqrt[m]{z}$  with deleted branch points.

To the trivial subgroup  $\{0\}$  there corresponds a simply connected infinite-sheeted covering, the Riemann surface of the function  $w = \text{Ln } z$ . A finite-sheeted covering is represented by the space  $\mathbb{C}_*$  and the universal covering by the plane  $\mathbb{C}$ .

2. The universal covering of the plane with two deleted points  $M = \mathbb{C} \setminus \{0, 1\}$  is the Riemann surface of a function that is inverse to the modular function (see subsection 44 of Part I). The covering space  $X$  here is the unit disc.

**22. Riemann domains.** This concept is close to the concept of coverings of domains  $D \subset \mathbb{C}^n$  and is the higher-dimensional analogue of the concept of a Riemann surface.

**DEFINITION.** A *Riemann domain* or *domain over  $\mathbb{C}^n$*  is a pair  $(\tilde{D}, \pi)$ , where  $\tilde{D}$  is an arcwise connected Hausdorff space and  $\pi: \tilde{D} \rightarrow \mathbb{C}^n$  is a local homeomorphism, called the *projection*.

A Riemann domain  $\tilde{D}$  may not cover the domain  $D = \pi(\tilde{D})$ , since boundary points of  $\tilde{D}$  may lie over certain points of  $D$ , and for such points there is no neighborhood  $U$  in which  $\pi^{-1}(U)$  is homeomorphic to the product of  $U$  and a discrete set (Figure 25). However, often Riemann domains are called coverings, and coverings in the sense accepted by us—coverings without boundary.

Using the projection  $\pi$  we introduce a structure of a manifold in the space  $\tilde{D}$ , and moreover, that of a complex manifold. For this it suffices to consider a covering of  $\tilde{D}$  by fine enough domains  $\tilde{U}_\alpha$  that  $\pi$  is a homeomorphism on them, and to introduce  $z^\alpha = \pi(p)$ ,  $p \in \tilde{U}_\alpha$ , as a local coordinate in  $\tilde{U}_\alpha$ . The compatibility relations of the atlas  $(\tilde{U}_\alpha, z^\alpha)$  are identity (and hence, biholomorphic) mappings, i.e., this is a complex atlas.

We remark that not only are holomorphic functions well defined on Riemann domains (as on any complex manifold), but also their derivatives. Namely, for any functions  $f$  holomorphic at a point  $p \in \tilde{D}$ , its *derivative* of order  $k = (k_1, \dots, k_n)$  at this point is

$$D^k f|_p = \frac{\partial^{|k|}}{\partial z_1^{k_1} \dots \partial z_n^{k_n}} f \circ \pi|_{\tilde{U}}^{-1}(z),$$

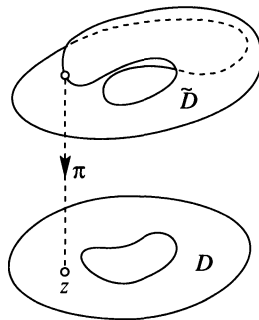

FIGURE 25

where  $\tilde{U}$  is a neighborhood of  $p$  in which the restriction  $\pi|_{\tilde{U}}$  is biholomorphic,  $\pi|_{\tilde{U}}^{-1}$  is the inverse mapping to it, and the right-hand side contains the derivative at the point  $z = \pi(p)$ .

Furthermore, on a Riemann domain  $(\tilde{D}, \pi)$  we can introduce in a natural way the concept of a *polydisc* with center at a point  $p \in \tilde{D}$  and radius  $r$  as a set  $\tilde{U}(p, r) \ni p$ , which  $\pi$  projects HOMEOMORPHICALLY into the polydisc  $U(z, r) \subset \mathbb{C}^n$ , where  $z = \pi(p)$ . The union of all polydiscs on  $\tilde{D}$  with a given center  $p$  is called the *maximal polydisc*, and the radius of this polydisc (finite or infinite) is called the *distance from  $p$  to the boundary of  $\tilde{D}$*  and is denoted by  $\rho(p, \partial\tilde{D})$ . The distance to the boundary of a set  $N \subset \tilde{D}$  is  $\inf_{p \in N} \rho(p, \partial\tilde{D})$ .

Riemann domains arise naturally in the process of analytic continuation. Since this process is carried out in the case of several variables exactly as in the case of one variable, we restrict ourselves to a brief description. We start from an *element*  $(U, f)$  with center at a point  $a \in \mathbb{C}^n$ , i.e., a pair formed from a polydisc  $U = U(a, r)$  and a holomorphic function  $f(z) = \sum_{k=0}^{\infty} c_k (z - a)^k$  in  $U$ . As in the case of one variable (Part I), we define direct analytic continuation and continuation along a path  $\gamma: I \rightarrow \mathbb{C}^n$ ,  $\gamma(0) = a$ , and we can also prove that the result of continuation along the path  $\gamma$  does not change under a homotopy with fixed endpoints if continuation is possible along any path  $\gamma_s$  that realizes this homotopy.

An *analytic function* of  $n$  complex variables, as in Part I, is a set of elements  $F = \{(U_\alpha, f_\alpha)\}_{\alpha \in A}$ , each of which is obtained from any other analytic continuation along some path in  $\mathbb{C}^n$ . Generally speaking, an analytic function is not a function in the domain  $D$  where it is constructed, since it can associate several values to points  $z \in D$ . However, as we shall now show, it is a function in some Riemann domain over  $D$ .

Assume that the analytic function  $F$  in a domain  $D \subset \mathbb{C}^n$  is defined by an element  $(U, f)$ . Since we are not interested in the radius of the polydisc  $U$ , we can take instead of the element  $(U, f)$  the *GERM*  $\mathbf{f}_a$  represented by this element (the point  $a \in D$  is its center; see subsection 29 of Part I). We provide the germs  $\mathbf{f}_z^\alpha$  at a point  $z \in D$  with a parameter  $\alpha \in A_z$ ; these germs are represented by elements obtained from  $(U, f)$  by continuations along all the possible paths  $\gamma: I \rightarrow D$  from  $a$  to  $z$ , and we consider the set  $\tilde{D}$  of pairs  $Z = (z, \mathbf{f}_z^\alpha)$ , where  $z \in D$  and  $\alpha \in A_z$ .

We introduce a topology in  $\tilde{D}$  in the following way. A neighborhood of a point  $Z = (z, \mathbf{f}_z^\alpha) \in \tilde{D}$  will be considered to be the set of all points  $W = (w, \mathbf{f}_w^\beta) \in \tilde{D}$  such that: (1)  $\|w - z\| < \varepsilon$ , where  $\varepsilon > 0$  is a fixed number,<sup>(30)</sup> and (2) the germ  $\mathbf{f}_w^\beta$  is represented by an element  $(V_w, f^\beta)$  which is a direct analytic continuation of the element  $(U_z, f^\alpha) \in \mathbf{f}_z^\alpha$ . It is obvious that for sufficiently small  $\varepsilon$  such a neighborhood is not empty.

<sup>(30)</sup> Recall that for a point  $z \in \mathbb{C}^n$  we denote by  $\|z\| = \max_\nu |z_\nu|$  its polydisc norm.

We leave it to the reader to prove that in this topology  $\tilde{D}$  is a connected Hausdorff space.

We define the projection  $\pi: \tilde{D} \rightarrow D$  to be the mapping  $(z, \mathbf{f}_z^\alpha) \rightarrow z$ ; this is obviously continuous and locally a homeomorphism. Thus, we have constructed a manifold, which is called the *Riemann domain of the analytic function*  $\mathcal{F}$  (by analogy with Riemann surfaces of analytic functions of one variable; see subsection 33 of Part I).

If the element  $(U, f)$  admits a continuation along ALL paths  $\gamma: I \rightarrow D$ , then the Riemann domain  $\pi: \tilde{D} \rightarrow D$  will obviously be a covering. By what was proved in subsection 20 the cardinality of all the stalks  $\pi^{-1}(z)$  of this covering is the same for all points  $z \in D$  and is at most countable. The sets  $\pi^{-1}(z)$ ,  $z \in D$ , will also be at most countable, even in the general case when the element is continued along certain paths in  $D$  and not along others (only now these cardinalities might be different for distinct points). The cardinality of  $\pi^{-1}(z)$  is the number of values of the “multiple-valued function”  $F$  at the point  $z \in D$ . It is more correct, however, to consider  $F$  as a (single-valued) function on  $\tilde{D}$ , namely, as a function associating the value  $f^\alpha(z)$  to the point  $(z, \mathbf{f}_z^\alpha) \in \tilde{D}$ , where  $(U_z, f^\alpha)$  is any representative of the germ  $\mathbf{f}_z^\alpha$ . This function is obviously holomorphic on  $\tilde{D}$ .

In the following chapter we shall consider questions of the analytic continuation of functions of several variables that show essential difference of the latter from functions of one variable.

### §8. Analytic sets

In this section we shall consider one of the basic objects of complex analysis, arising naturally in the geometric study of holomorphic functions—sets on which these functions vanish.

**23. The Weierstrass preparation theorem.** This theorem (Vorbereitungssatz) was published in 1879 and lies at the foundation of the connection between complex analysis and algebra. It generalizes the well-known property of holomorphic functions of one variable of vanishing like integer powers of  $z - a$ : If  $f(a) = 0$  (but  $f \not\equiv 0$ ), then in some neighborhood of the point  $a$

$$f(z) = (z - a)^k \varphi(z), \quad (1)$$

where  $\varphi$  is holomorphic and does not vanish.

In the higher-dimensional case instead of powers of  $z - a$ , a polynomial in one of the variables, say  $z_n$ , occurs, with coefficients that depend holomorphically on the remaining variables  $'z = (z_1, \dots, z_{n-1})$ .

**THEOREM 1.** *Suppose the function  $f$  is holomorphic in some neighborhood  $U$  of a point  $a \in \mathbb{C}^n$  and  $f(a) = 0$  but  $f'(a, z_n) \not\equiv 0$ ; then in some neighborhood  $V$  of this point*

$$f(z) = \{(z_n - a_n)^k + c_1('z)(z_n - a_n)^{k-1} + \dots + c_k('z)\} \varphi(z), \quad (2)$$



where  $k \geq 1$  is the order of the zero of  $f'(a, z_n)$  at the point  $z_n = a_n$ , the functions  $c_\nu$  are holomorphic in  $'V$ ,  $c_\nu('a) = 0$ , and  $\varphi$  is holomorphic in  $V$  and does not vanish there.

◀ Without loss of generality we may assume that  $a = 0$ . By the uniqueness theorem for functions of one variable we can choose an  $r_n > 0$  so that  $f('0, z_n) \neq 0$  for  $0 < |z_n| \leq r_n$ , and since  $f$  is continuous there is a polydisc  $'V('0, r)$  such that  $f('z, z_n) \neq 0$  for  $'z \in 'V$ ,  $|z_n| = r_n$ . For any fixed  $'z^0 \in 'V$  the number of zeros of the function  $f('z^0, z_n)$  in the disc  $V_n = \{|z_n| < r_n\}$  is equal to

$$\frac{1}{2\pi i} \int_{\partial V_n} \frac{\frac{\partial}{\partial z_n} f('z^0, z_n)}{f('z^0, z_n)} dz_n = k, \quad (3)$$

since the left-hand side of (3) is an integer and continuous function of the point  $'z^0$  in  $'V$  <sup>(31)</sup> and hence is constant, and for  $'z^0 = '0$  it is equal to the order of the zero of the function  $f('0, z_n)$  at the point  $z_n = 0$ , i.e.,  $k$ .

We fix  $'z \in 'V$ , denote by  $z_n^{(\nu)} = z_n^{(\nu)}('z)$ ,  $\nu = 1, \dots, k$ , the zeros of  $f('z, z_n)$  in the disc  $V_n$ , and we construct a polynomial relative to  $z_n$

$$P(z) = \prod_{\nu=1}^k (z_n - z_n^{(\nu)}) = z_n^k + c_1('z)z_n^{k-1} + \dots + c_k('z), \quad (4)$$

having these zeros as its roots. Its coefficients are holomorphic in  $'V$ . In fact, for any holomorphic function  $\omega(z_n)$  in  $\overline{V}_n$  by the generalized argument principle (see the exercise after Theorem 1 in subsection 34 of Part I) we have

$$\sum_{\nu=1}^k \omega(z_n^{(\nu)}) = \frac{1}{2\pi i} \int_{\partial V_n} \omega(z_n) \frac{\frac{\partial}{\partial z_n} f('z, z_n)}{f('z, z_n)} dz_n,$$

from which we see that the sums in the left-hand side are holomorphic functions of the variable  $'z$  in  $'V$  (taking into account that  $f \neq 0$  for  $'z \in 'V$  and  $z_n \in \partial V_n$ ). Setting  $\omega(z_n) = z_n^\mu$ ,  $\mu = 1, \dots, k$ , here, we will find that the sums of the  $\mu$ th powers of the roots of the polynomial (4) are holomorphic in  $'V$ , and its coefficients are expressed rationally by means of these sums (as is well known from algebra), and hence  $c_\nu \in \mathcal{O}('V)$ . For  $'z = '0$  all  $k$  roots of the polynomial are equal to zero, so that all the  $c_\nu('0) = 0$ .

For any fixed  $'z \in 'V$  the function

$$\varphi(z) = \frac{f(z)}{P(z)}$$

is a holomorphic function of  $z_n$  in  $V_n$  and does not vanish, since  $P$  vanishes of the same order only at the points  $z_n^{(\nu)}('z)$  at which  $f$  is also zero.

<sup>(31)</sup> See the Lemma at the end of subsection 5.

Therefore for any  $'z \in 'V$   $\varphi$  is represented by a Cauchy integral with respect to the variable  $z_n$ :

$$\varphi(z) = \frac{1}{2\pi i} \int_{\partial V_n} \frac{f('z, \zeta_n) d\zeta_n}{P('z, \zeta_n) \zeta_n - z_n},$$

and thus is defined at those points of  $V = 'V \times V_n$  at which  $P = 0$ . Since  $P \neq 0$  on  $\partial V_n$  (since  $f \neq 0$  there), then the right-hand side, and hence  $\varphi$ , depends holomorphically on  $'z$ . By Hartogs's theorem  $\varphi$  is holomorphic in the polydisc  $V$ . ►

The Weierstrass preparation theorem shows that a holomorphic function vanishes like a polynomial relative to the variable  $z_n$  with coefficients from the ring  $\mathcal{O}_a$  of functions of  $'z$  that are holomorphic at  $'a$ :

$$P('z, z_n) = (z_n - a_n)^k + c_1('z)(z_n - a_n)^{k-1} + \cdots + c_k('z). \quad (5)$$

More precisely, all the coefficients of this polynomial, except the leading one, belong to the IDEAL<sup>(32)</sup> of the ring  $\mathcal{O}_a$  formed by the functions that vanish at  $'a$ ; a polynomial with these properties is called a *Weierstrass polynomial* at this point. Thus, Theorem 1 allows us to invoke algebraic methods for the study of the sets of zeros of holomorphic functions.

REMARK. If  $f \neq 0$  and all the conditions of the Weierstrass theorem hold, except for the condition  $f('a, z_n) \neq 0$ , then we choose a point  $z^0$  in  $U$  at which  $f(z^0) \neq 0$ , and we turn the coordinate axes so that the  $z_n$  axis is parallel to the complex line passing through  $a$  and  $z^0$ . Then the condition  $f('a, z_n) \neq 0$  will also hold.

We also note that the complex implicit function theorem follows in a simple way from Weierstrass's theorem: if  $f(a) = 0$ , but  $\frac{\partial f}{\partial z_n}(a) \neq 0$ , then Theorem 1 is applicable with  $k = 1$ . Therefore the equation  $f(z) = 0$  in a neighborhood of  $a$  is equivalent to the equation  $P(z) = z_n - a_n + c_1('z) = 0$ , which is solvable relative to  $z_n$  and  $z_n = a_n - c_1('z)$  is a holomorphic function of the remaining variables.

From the same theorem we get the property of level sets that we used in subsection 9: on the level set  $\{f(z) = 0\}$  of a function  $f$  that is holomorphic at  $a$  there exists a smooth path starting from  $a$ . In fact, the level  $\{f(z) = 0\}$  can be described by the equation  $P('z, z_n) = 0$ , where  $P$  is the Weierstrass polynomial of  $f$  at  $a$ . If  $\gamma: [0, 1] \rightarrow 'V$ ,  $\gamma(0) = 'a$ , is a smooth path, then the coefficients  $c_j \circ \gamma(t)$  of this polynomial depend smoothly on  $t$ , and they tend to 0 as  $t \rightarrow 0$ . Therefore there is a root  $z_n(t)$  of the polynomial, which depends smoothly on  $t$ , and tends to  $a_n$  as  $t \rightarrow 0$ ; the path  $[0, 1] \rightarrow (\gamma(t), z_n(t))$  is the desired one.

For  $n = 2$  the Weierstrass expansion of a function  $f \neq 0$  can be given the form

$$f(z, w) = (z - a)^k \{(w - b)^l + c_q(z)(w - b)^{l-1} + \cdots + c_k(z)\} \varphi(z, w), \quad (6)$$

<sup>(32)</sup> Recall that an *ideal* of a ring  $R$  is a set  $I$  of elements of  $R$  that: (1) is a subgroup of the additive group of the ring (for this the difference of any two elements of  $I$  must again belong to  $I$ ) and (2) for any element  $j \in I$  and any  $r \in R$  the product  $jr \in I$ . The set of all functions belonging to  $\mathcal{O}_a$ , equal to zero at  $'a$ , satisfies both these conditions.

for which the condition  $f(a, w) \neq 0$  is not required (here the  $c_\nu$  are holomorphic functions at the point  $a \in \mathbb{C}$ ,  $c_\nu(a) = 0$ ,  $k$  and  $l$  are integers,  $\varphi$  is a nonvanishing holomorphic function at the point  $(a, b) \in \mathbb{C}^2$ ). In fact, if  $f(a, w) \neq 0$ , then we have the expansion (6) with  $k = 0$ ; but if  $f(a, w) \equiv 0$ , then from the Taylor expansion we obtain that  $f(z, w) = (z-a)^k g(z, w)$ , where  $g(a, w) \neq 0$ , and applying the theorem to  $g$ , we arrive at the expansion (6).

We shall also need the so-called WEIERSTRASS DIVISION THEOREM:

**THEOREM 2.** *Suppose that  $f$  is a holomorphic function in a neighborhood of a point  $a \in \mathbb{C}^n$  and that  $P$  is some Weierstrass polynomial at this point,<sup>(33)</sup> and let  $k$  be its degree (relative to  $z_n$ ). Then in some neighborhood of  $a$  the function  $f$  is represented in a natural way in the form*

$$f = P\varphi + Q, \quad (7)$$

where the function  $\varphi$  is holomorphic at  $a$ , and  $Q$  is a polynomial with respect to  $z_n$  of degree not greater than  $k - 1$  with coefficients that are holomorphic in a neighborhood of the point  $'a \in \mathbb{C}^{n-1}$ .

◀ Without loss of generality we assume that  $a = 0$ . We choose a circle  $\{|z_n| = r\}$  so that  $P('z, z_n) \neq 0$  on it for all  $'z$  belonging to a neighborhood  $'U$  of  $'a$ , and we set

$$\varphi(z) = \frac{1}{2\pi i} \int_{\{|\zeta_n|=r\}} \frac{f('z, \zeta_n)}{P('z, \zeta_n)} \frac{d\zeta_n}{\zeta_n - z_n}.$$

Then  $\varphi$  is holomorphic in  $U = 'U \times \{|z_n| < r\}$ , just like the function

$$\begin{aligned} Q(z) &= f(z) - P(z)\varphi(z) \\ &= \frac{1}{2\pi i} \int_{\{|\zeta_n|=r\}} \frac{f('z, \zeta_n)}{P('z, \zeta_n)} \frac{P('z, \zeta_n) - P('z, z_n)}{\zeta_n - z_n} d\zeta_n. \end{aligned}$$

The second factor in the integrand is a polynomial in  $z_n$  of degree at most  $k - 1$  with coefficients that are holomorphic in  $'U$  for any  $\zeta_n$ ,  $|\zeta_n| = r$ :

$$\frac{P('z, \zeta_n) - P('z, z_n)}{\zeta_n - z_n} = q_1('z, \zeta_n)z_n^{k-1} + \dots + q_k('z, \zeta_n).$$

Substituting this expression in the preceding one and integrating over  $\{|\zeta_n| = r\}$ , we will find that

$$Q(z) = b_1('z)z_n^{k-1} + \dots + b_k('z),$$

where the functions

$$b_j('z) = \frac{1}{2\pi i} \int_{\{|\zeta_n|=r\}} \frac{f('z, \zeta_n)}{P('z, \zeta_n)} q_j('z, \zeta_n) d\zeta_n, \quad j = 1, \dots, k,$$

are holomorphic in  $'U$ . This proves the existence of the decomposition (7); it remains to prove the uniqueness.

<sup>(33)</sup> Not necessarily of the function  $f$ .

Suppose that along with (7) there is another decomposition  $f = P\varphi_1 + Q_1$  with the same properties. Then

$$P(\varphi_1 - \varphi) = Q - Q_1,$$

and if  $\varphi_1 \not\equiv \varphi$ , then the power of  $z_n$  in the left-hand side is at least  $k$ , while on the right it is at most  $k - 1$ . This contradiction shows that  $\varphi_1 \equiv \varphi$ , and hence, that  $Q_1 \equiv Q$ . ▶

We illustrate this theorem in applying it to the important concept of irreducibility for analytic sets. We recall first some results from algebra, limiting ourselves for definiteness to the ring  $\mathcal{P}_a$  of polynomials in  $z_n$  with coefficients that are holomorphic in a neighborhood of  $'a \in \mathbb{C}^{n-1}$ . A polynomial  $P \in \mathcal{P}_a$  is said to be *irreducible* if it cannot be decomposed into the product of two polynomials  $P_1, P_2 \in \mathcal{P}_a$  of degrees at least 1. Any polynomial  $P \in \mathcal{P}_a$  can be represented in the form

$$P = P_1^{m_1} \cdots P_l^{m_l}, \quad (8)$$

where the  $P_j$  are irreducible polynomials belonging to  $\mathcal{P}_a$  and the  $m_j$  are natural numbers, and this decomposition is unique up to factors that are holomorphic and nonzero in a neighborhood of  $'a$ .

Furthermore, if we are given two polynomials  $P, Q \in \mathcal{P}_a$ ,  $\deg P \geq \deg Q$ , then we can apply *Euclid's algorithm* of successive division:

$$\begin{aligned} P &= q_1 Q + r_1, & Q &= q_2 r_1 + r_2, \\ r_1 &= q_3 r_2 + r_3, & \dots, & r_{k-2} = q_k r_{k-1} + r_k \end{aligned} \quad (9)$$

(all the  $q_j, r_j \in \mathcal{R}_a$ —the set of polynomials in  $z_n$  whose coefficients are quotients of functions that are holomorphic in a neighborhood of  $'a$ , and  $\deg r_j < \deg r_{j-1}$ ,  $r_0 = Q$ ) until we obtain in the remainder a function depending only on  $'z$  (a polynomial of degree zero with respect to  $z_n$ ):

$$r_{k-1}(z) = q_{k+1}(z)r_k(z) + r'(z). \quad (10)$$

If we clear the denominators in the expression for  $r$  that arise in the process of division of coefficients (there are a finite number of them), then we obtain a holomorphic function

$$R'(z) = a'(z)r'(z), \quad (11)$$

which is called the *resultant* of the polynomials  $P$  and  $Q$ .

The resultant is identically equal to 0, then  $r'(z) \equiv 0$  and, as we see from (10) and (9), both the polynomials  $P$  and  $Q$  are divisible by  $r_k \in \mathcal{R}_a$ , a polynomial in  $z_n$  of degree at least 1:  $P = \tilde{p}r_k$ ,  $Q = \tilde{q}r_k$ , where  $\tilde{p}, \tilde{q} \in \mathcal{R}_a$ . Since the left-hand sides of these equalities belong to  $\mathcal{P}_a$ , then after truncating the coefficients in their right-hand sides they are transformed to the form

$$P = pR_k, \quad Q = qR_k, \quad (12)$$

where  $p, q, R_k \in \mathcal{P}_a$ , and  $R_k(z) = c_k('z)r_k(z)$  is a polynomial in  $z_n$  of degree at least 1.

In the general case each remainder  $r_j$  is expressed linearly by means of the two preceding ones ( $r_{j-1}$  and  $r_{j-2}$ ); substituting these expressions successively in (10) and (9) and clearing the denominators, we find that the resultant

$$R('z) = p(z)P(z) + q(z)Q(z), \quad (13)$$

where  $p$  and  $q$  are certain polynomials from  $\mathcal{P}_a$ . From this we see that if for some  $'z$  the polynomials  $P$  and  $Q$  have a common root (with respect to  $z_n$ ), then  $R('z) = 0$ . Conversely, if  $R('z) = 0$  and for this  $'z$  the leading coefficients of  $P$  and  $Q$  are not equal to 0, then in (11) we have  $a('z) \neq 0$ , but  $r('z) = 0$ ; therefore  $P('z, z_n)$  and  $Q('z, z_n)$  are divisible by  $r_k('z, z_n)$  and hence have a common root (with respect to  $z_n$ ).

The resultant of a polynomial  $P \in \mathcal{P}_a$  and its derivative  $\partial P/\partial z_n$  is called the *discriminant* of this polynomial. From what has been stated above it follows that the discriminant of a polynomial  $P$  (if its leading coefficient does not vanish) is equal to 0 for exactly those values of  $'z$  for which  $P$  has multiple roots (with respect to  $z_n$ ).

EXAMPLE. Let  $P(z) = z_2^3 - 3z_1^2 z_2 + 2z_1^3 - z_1$ ; then  $\partial P/\partial z_2 = 3z_2^2 - 3z_1^2$  and the Euclidean algorithm gives  $r_3(z_1) = (-4z_1^3 + z_1)/(2z_1^2 - 1)$ . After clearing the denominator, we will obtain the discriminant  $\Delta(z_1) = 4z_1^3 - z_1$ . Thus, the polynomial  $P$  has multiple roots with respect to  $z_2$  only for  $z_1 = 0$  (the triple root  $z_2 = 0$ ), for  $z_1 = 1/2$  (the double root  $z_2 = -1/2$ ), and for  $z_1 = -1/2$  (the double root  $z_2 = 1/2$ ).

If the discriminant of a polynomial  $P$  is identically equal to zero, then  $P$  is certainly reducible, since according to (12)  $P$  then has a factor  $R_k$  of degree at least 1 and at most  $\deg P - 1$  (and  $\partial P/\partial z_n$  is also divisible by it). This result is generalized by

**THEOREM 3.** *If all the factors in the decomposition  $P = P_1 \cdots P_l$  of a polynomial  $P \in \mathcal{P}_a$  into irreducible polynomials are distinct, then the discriminant of  $P$  is not identically equal to 0.*

◀ If this discriminant  $\Delta \equiv 0$ , then by (12) the polynomials  $P$  and  $\partial P/\partial z_n$  have a common nontrivial factor  $R_k$ . In view of the uniqueness of the decomposition into irreducible factors  $R_k$  must (up to a factor depending only on  $'z$ ) coincide with one of the  $P_j$ . But, from the formula for differentiating a product we see that

$$\frac{\partial P}{\partial z_n} = \frac{\partial P_1}{\partial z_n} P_2 \cdots P_l + \cdots + P_1 \cdots P_{l-1} \frac{\partial P_l}{\partial z_n},$$

the derivative  $\partial P/\partial z_n$  cannot be divided by any of the  $P_j$ . ▶

The concept of the irreducibility of functions is closely connected with the concept of irreducibility of polynomials. A function  $f \neq 0$  that is holomorphic at a point  $a \in \mathbb{C}^n$  and equal to 0 there is said to be *irreducible* at this point if it cannot be represented as a product of functions holomorphic at  $a$ ,

each of which is equal to 0 at  $a$ . Without loss of generality we may assume that  $f'(a, z_n) \neq 0$ , and then we may form the Weierstrass polynomial  $P$  of  $f$  at  $a$ . If  $f$  is reducible at  $a$ , then we can apply the theorem of Weierstrass to each of the factors into which  $f$  splits; we find that  $P$  is the product of the Weierstrass polynomials of these factors, i.e., is reducible. Conversely, if  $P$  is reducible, then it splits into a product of polynomials equal to zero at  $a$  (this follows from the fact that  $P'(a, z_n) = (z_n - a_n)^k$  by the property of the coefficients of Weierstrass polynomials), and hence,  $f$  is reducible at this point.

It follows from all this that each function  $f \neq 0$  that is holomorphic at a point  $a \in \mathbb{C}^n$  and equal to 0 there splits uniquely (up to holomorphic and nonzero factors) into the product of factors that are irreducible at this point:

$$f = f_1^{m_1} \cdots f_l^{m_l} \quad (14)$$

(cf. the decomposition (8)).

To conclude we give a corollary of the Weierstrass division theorem, which expresses an important property of irreducible functions.

**THEOREM 4.** *Suppose the function  $f$  is holomorphic, vanishes, and is irreducible at a point  $a \in \mathbb{C}^n$ , and that the function  $g$  is holomorphic in a neighborhood of  $a$  and is equal to 0 where  $f = 0$ . Then  $g$  is divisible by  $f$  in the sense that in a neighborhood of  $a$  we have*

$$g = fh, \quad (15)$$

where  $h$  is a holomorphic function.

◀ Without loss of generality we assume that  $f'(a, z_n) \neq 0$ , and we denote by  $P$  the Weierstrass polynomial of  $f$  at  $a$ ; suppose that it is of degree  $k$ . Since it is irreducible, then its discriminant  $\Delta \neq 0$  and in a neighborhood of  $a$  there is a point  $z^0$  such that  $\Delta'(z^0) \neq 0$ , but  $f(z^0) = 0$ , and hence,  $P(z^0) = 0$ . By Theorem 2 the function  $g$  is representable in this neighborhood in the form

$$g = P\varphi + Q, \quad (16)$$

where  $Q \in \mathcal{P}_a$ ,  $\deg Q < k$ , and  $\varphi$  is a holomorphic function. Substituting the point  $z^0$  found above here, we see that for this value of  $z$  the polynomial  $P$  has  $k$  distinct roots  $z_n^j$ . But by hypothesis at the points  $(z^0, z_n^j)$  we also have that  $g = 0$ , and by (16)  $Q = 0$  at these points. Thus, the polynomial  $Q$ , which is of degree less than  $k$ , has  $k$  distinct roots, and hence  $Q \equiv 0$ . Therefore  $g = P\varphi$ , which is equivalent to (15). ▶

#### 24. Properties of analytic sets.

**DEFINITION 1.** An analytic set  $A$  in a domain  $D \subset \mathbb{C}^n$  is locally defined as the set of common zeros of a finite number of holomorphic functions. In other words, for any point  $a \in D$  there are a neighborhood  $U \subset D$  and a

finite set of functions  $f_\mu \in \mathcal{O}(U)$  such that

$$A \cap U = \{z \in U : f_1(z) = \cdots = f_k(z) = 0\}. \quad (1)$$

A trivial special case of an analytic set in  $D$  is the domain  $D$  itself; here all the  $f_\mu \equiv 0$ . If the analytic set  $A \neq D$ , then we can choose incompatible systems as  $\{f_\mu = 0\}$  in the neighborhoods  $U \subset D \setminus A$ . The simplest properties of such sets are:

**THEOREM 1.** *An analytic set  $A$  in a domain  $D$ ,  $A \neq D$ , is closed, nowhere dense in  $D$ , and does not separate  $D$ .*

◀ Let  $a \in D$  be a limit point of a sequence  $a^\mu \in A$ ; in a neighborhood  $U \ni a$  the set  $A \cap U$  is defined by formula (1). Since the functions  $f_\mu$  are continuous, the point  $a \in A$  and the first assertion is proved.

If  $A$  has an interior point in  $D$ , then its interior  $E$  is nonempty. But  $E$  is also closed in  $D$ , since a limit point  $z^0 \in D$  of the set  $E$  belongs to  $E$  since  $A$  is closed and in view of the uniqueness theorem for holomorphic functions. Since  $D$  is connected, then  $E = D$ , which contradicts the hypothesis, and the second assertion is proved.

In order to prove the last assertion it suffices to prove that each point  $a \in A$  has a connected neighborhood  $U$  such that  $U \setminus A$  is connected. Let  $a \in A$  be an arbitrary point, let  $U \subset D$  be a CONVEX neighborhood of  $a$ , and let  $z^0$  and  $z^1$  be arbitrary points of  $U \setminus A$ . Let  $G = \{\zeta \in \mathbb{C} : \zeta z^0 + (1 - \zeta)z^1 \in U\}$  be the intersection of  $U$  and the complex line joining  $z^0$  and  $z^1$ ; this is a convex domain on the plane. Among the functions defining  $A$  in the neighborhood  $U$  there is one such that

$$g_\mu(\zeta) = f_\mu(\zeta z^0 + (1 - \zeta)z^1) \neq 0,$$

and hence the set  $H = \{\zeta \in \mathbb{C} : \zeta z^0 + (1 - \zeta)z^1 \in A\}$  is discrete. The set  $G \setminus H$  is therefore connected, and since it contains the points  $\zeta_0 = 0$  and  $\zeta_1 = 1$ , there is a path  $\gamma: I \rightarrow G \setminus H$  that joins  $\zeta_0$  and  $\zeta_1$ ; then the function  $t \rightarrow \gamma(t)z^0 + (1 - \gamma(t))z^1$  defines a path in  $U \setminus A$  connecting  $z^0$  and  $z^1$ . ▶

If the functions (1) can be chosen in some neighborhood  $U \ni a$  so that the rank of the Jacobi matrix  $(\partial f_\mu / \partial z_\nu)_a$  is equal to  $k$ , then  $a$  is called a *regular point* of the set  $A$ , and the number  $n - k = m$  is the *complex dimension* of  $A$  at the point  $a$ , and is denoted  $\dim_a A$ . The set of regular points of a set  $A$  will be denoted  $A^0$ , and the points of  $A \setminus A^0$  are called *critical points* of  $A$ .

**EXAMPLE.** For the set  $A = \{z \in \mathbb{C}^3 : z_1 z_2 z_3 = 0\}$  consisting of the three hyperplanes  $H_\nu = \{z_\nu = 0\}$  the Jacobi matrix of the function  $f(z) = z_1 z_2 z_3$  has the form  $\nabla f = (z_2 z_3, z_1 z_3, z_1 z_2)$ . Its rank is equal to 1 everywhere on  $A$  except for the complex lines  $l_1 = H_2 \cap H_3$ ,  $l_2 = H_1 \cap H_3$ ,  $l_3 = H_1 \cap H_2$ , on which  $\nabla f = 0$ . Consequently, the set of critical points of  $A$  is equal to their union  $L = l_1 \cup l_2 \cup l_3$ , and the set of regular points  $A^0 = A \setminus L$ .

**THEOREM 2.** *A set  $A^0$  of regular points of an analytic set  $A$  is open in  $A$ , and its connected components are complex manifolds.*

◀ It is obvious that  $A^0$  is open, since if the set  $A$  is given by the equations (1) in a neighborhood  $U$  and  $a \in U$  is a regular point of  $A$ , then the matrix  $f'$  has a minor of order  $k$  that is nonzero at  $a$ ; this minor is also nonzero in a neighborhood of  $a$ , and hence, the points of  $A$  belonging to this neighborhood are also regular. Suppose that this is the minor  $\det(\partial f_\mu / \partial z_\nu)$ , where  $\mu = 1, \dots, k$ , and  $\nu = m+1, \dots, n$  ( $m = n - k$ ). By the implicit function theorem (see subsection 9) in a neighborhood of  $a$  the set  $A$  can be given by the equations

$$z_\nu = g_\nu(z_1, \dots, z_m) \quad (\nu = m+1, \dots, n), \quad (2)$$

where the  $g_\nu$  are holomorphic functions.

Thus, in this neighborhood the set  $A$  is given as the graph of a holomorphic mapping, and hence, is a complex manifold of dimension  $m = n - k$ . The same statement also holds for the connected component of  $A^0$  containing  $a$ . ▶

Passing to the set  $A^c = A \setminus A^0$  of critical points of  $A$ , we note that it belongs to an analytic subset of  $A$  different from  $A$  itself. In fact, let  $a$  be a critical point of  $A$  and  $k$  the largest integer such that in a neighborhood  $U$  there exist holomorphic functions  $f_1, \dots, f_k$  equal to 0 on  $A$ , and the matrix  $f'$  has a minor  $D$  of order  $k$ , not identically equal to 0 in  $U$ . Let  $\tilde{A}$  be the set of points of  $U$  at which  $f_1 = \dots = f_k = 0$  and this minor is nonzero. For any function  $f \in \mathcal{O}(U)$ , equal to 0 on  $A \cap U$ , the differential  $df$  is a linear combination of  $df_1, \dots, df_k$ , since otherwise  $f$  can be added to the  $f_\mu$  and  $k$  is not maximal, and hence,  $df = 0$  on  $\tilde{A}$ .

From this it follows that in a neighborhood of the points  $z^0 \in \tilde{A}$  the set  $\tilde{A}$  coincides with  $A$  and that these points are regular points of  $A$ . Thus, the points of  $A^c \cap U$  must belong to the set  $\{z \in A \cap U : D(z) = 0\}$  and our assertion is proved. A more complicated argument, which we do not give, allows us to obtain a stronger result.<sup>(34)</sup>

**THEOREM 3.** *The set  $A^c$  of critical points of an analytic set  $A$  is an analytic set distinct from  $A$ .*

**REMARK.** In a neighborhood of critical points an analytic set may not even be a topological manifold. Consider, for example, the analytic set  $A = \{z_1 z_2 = z_3^2 = 0\}$  in  $\mathbb{C}^3$ . Its Jacobi matrix has the form  $(z_2, z_1, -2z_3) \neq 0$ , hence it is two-dimensional, and  $0 \in \mathbb{C}^3$  is a critical point of it. If this set were a manifold in a neighborhood of 0, then  $A \setminus \{0\}$  would be locally homeomorphic to a ball of real dimension 4 with a deleted point, i.e.,  $A \setminus \{0\}$  would be a simply connected set. But the mapping  $g: (\zeta_1, \zeta_2) \rightarrow (\zeta_1^2, \zeta_2^2, \zeta_1 \zeta_2)$  defines  $\mathbb{C}^2 \setminus \{0\}$  as a two-sheeted covering of  $A \setminus \{0\}$  and by the monodromy theorem of subsection 20 the set  $A \setminus \{0\}$  cannot be simply connected.

Arguing as in the proof of Theorem 1, we can deduce from Theorem 3 that  $A^c$  is closed and nowhere dense in  $A$  (the last follows already from the

<sup>(34)</sup> See E. M. CHIRKA, *Complex analytic sets*, "Nauka", Moscow, 1985; English transl., Kluwer Academic. Norwell, MA, 1989.



part of the theorem that we did prove). However, as the example preceding Theorem 2 of this subsection shows,  $A^c$  can separate  $A$ ; for more details see below.

From Theorem 2 we see that the concept of the dimension of an analytic set at its regular points, introduced above in a formal way, coincides with the geometric definition of the dimension of a complex manifold. Since the set  $A^0$  of regular points is everywhere dense in  $A$ , then for any point  $a \in A$  by definition we can set

$$\dim_a A = \overline{\lim_{\substack{z \rightarrow a \\ z \in A^0}} \dim_z A}; \quad (3)$$

we call the number  $\dim A = \sup_{a \in A} \dim_a A$  the *dimension of the set  $A$* ; the number  $n - \dim A$  is called the *codimension* of  $A$ . The set  $A$  is said to be *pure  $m$ -dimensional* if  $\dim_a A = m$  for all  $a \in A$ .

Analytic sets  $A \subset \mathbb{C}^n$  of codimension 1 ( $\dim A = n - 1$ ) are called *complex hypersurfaces*, and sets of dimension 1 are called *complex curves*. Sets without critical points ( $A^c = \emptyset$ ) are (locally finite) unions of complex manifolds; sometimes such sets are said to be *smooth*.

One can prove that, for each  $k$ ,  $0 \leq k \leq m = \dim A$ , the set  $A_{(k)} = \{a \in A : \dim_a A = k\}$  is analytic (perhaps empty), and it is obviously pure  $k$ -dimensional. Thus, each analytic set is represented as a finite union of pure-dimensional analytic sets:  $A = \bigcup_{k=0}^m A_{(k)}$ . If  $a$  is a critical point of  $A$ , then  $\dim_a(A \setminus A^0) < \dim_a A$ , and hence the dimension of the set of critical points of a pure  $m$ -dimensional analytic set  $A$  is strictly less than  $m$ .

Since Theorem 3 is also applicable to the analytic set  $A \setminus A^0$ , we will obtain a decomposition of the analytic set into complex manifolds:  $A = A^0 \cup (A \setminus A^0)^0 \cup \dots$ . A more convenient decomposition into manifolds whose dimensions strictly decrease is:

$$A = A_{(m)}^0 \cup (A \setminus A_{(m)}^0)_{(m-1)}^0 \cup \dots \quad (m = \dim A). \quad (4)$$

Such a decomposition is called a *stratification* of the analytic set, and its factors are the *strata* of the corresponding dimension.

**EXAMPLE 1.** For the set  $A = \{z \in \mathbb{C}^3 : z_1 z_2 z_3 = 0\}$  from the example preceding Theorem 2 of this subsection the two-dimensional stratum is  $A_{(2)}^0 = A \setminus L$ , the one-dimensional one is  $L \setminus \{0\}$ , and the zero-dimensional one is the point  $\{0\}$ .

**DEFINITION 2.** An analytic set  $A$  is said to be *irreducible* in a domain  $D$  if it cannot be represented as a union of analytic sets in  $D$  different from  $A$  itself. The set  $A$  is said to be *irreducible at a point  $a \in A$*  if in any sufficiently small neighborhood  $U$  of  $a$  the set  $A \cap U$  is irreducible.

**EXAMPLES.**

2. The analytic set  $A = \{z_1^2 z_2^2 - z_3^2 = 0\}$  is reducible in  $\mathbb{C}^3$ , since it splits into two sets  $A_1 = \{z_1 z_2 - z_3 = 0\}$  and  $A_2 = \{z_1 z_2 + z_3 = 0\}$ . It is also reducible at all points of the intersection  $A_1 \cap A_2$ , i.e., on the lines  $(z_1, 0, 0)$  and  $(0, z_2, 0)$ ; it is irreducible at the remaining points.

3. The set  $\{z_1 z_2^2 - z_3^2 = 0\}$  is irreducible at the point  $z = 0$ , but it is reducible at all points

$(a_1, 0, 0)$ ,  $a_1 \neq 0$  (it is represented as the union of the sets  $\{\sqrt{z_1}z_2 \pm z_3 = 0\}$ , where  $\sqrt{z_1}$  denotes one of the branches of the square-root function).

4. The set  $\{z_1z_2 - z_3^2 = 0\}$  is irreducible at all its points (including the critical point  $z = 0$ ).

The concept of irreducibility of analytic sets is related to the concept of the irreducibility of functions which we considered in subsection 23. Suppose that the function  $f$ , holomorphic at a point  $a \in \mathbb{C}^n$ , is irreducible at this point; we shall show that then the analytic set  $A = \{f(z) = 0\}$  is irreducible at  $a$ . In fact, assuming the contrary, we assume that  $A = A_1 \cup A_2$  in a neighborhood of  $a$ , where  $A_1$  and  $A_2$  are complex hypersurfaces different from  $A$ , and hence, from each other. Then there are functions  $f_1$  and  $f_2$ , holomorphic at  $a$  and such that  $f_1|_{A_1} \equiv 0$ ,  $f_1|_{A_2} \neq 0$ , and analogously,  $f_2|_{A_2} \equiv 0$ ,  $f_2|_{A_1} \neq 0$ . The function  $f$  vanishes on the set  $\{f_1f_2 = 0\}$  and by the Weierstrass division theorem (see subsection 23)  $f_1f_2 = hf$ , where  $h$  is a holomorphic function at the point  $a$ ; thus,  $f$  is reducible, contradicting the hypothesis. The converse is false: let  $f^2$  be the square of a function that is irreducible at the point  $a$ , and hence  $f^2$  is reducible at  $a$ ; however, the set  $A = \{f^2 = 0\}$  coincides with  $\{f = 0\}$  and, by the previous argument, is irreducible at  $a$ .

In subsection 23 it was proved that any function that is holomorphic at a point  $a$  and equal to 0 there can be decomposed into a product of irreducible factors. From this, according to the argument given above, it follows that any complex hypersurface in a neighborhood of any of its points can be represented as a union of hypersurfaces that are irreducible at this point.

Furthermore, a complex hypersurface  $A$  is irreducible in a domain  $D$  if and only if its set of regular points  $A^0$  is connected. In fact, suppose  $A$  is reducible and splits into the union  $A_1 \cup A_2$  of analytic sets in  $D$ . All the points of the intersection  $A_1 \cap A_2$  are critical points ( $A$  is not a manifold in neighborhoods of them), so that the set  $A^c$  of critical points contains this intersection and, hence, separates  $A^0$  (it is impossible to get from  $A_1$  into  $A_2$  while avoiding  $A_1 \cap A_2$ ). Conversely, suppose  $A^0$  is not connected and splits into a union of connected hypersurfaces  $A_j$ ; we shall show that the closures  $\bar{A}_j$  are complex hypersurfaces in  $D$ , i.e.,  $A = \bar{A}^0$  is the union of the  $\bar{A}_j$  and, hence, is reducible.

Suppose the point  $a \in D$  belongs to  $\bar{A}_j$ ; since  $\bar{A}_j \subset A$ , in a neighborhood  $U \ni a$  the set is defined by the equation  $f(z) = 0$ , where  $f \in \mathcal{O}(U)$ . Without loss of generality we may assume that  $a = 0$  and  $f'(0, z_n) \neq 0$ , and we may replace  $f$  by its Weierstrass polynomial  $P'(z, z_n)$  at 0. Also without loss of generality we may assume that  $P$  is irreducible at 0, since otherwise  $P$  could be replaced by its irreducible factor that corresponds to the component  $A_j$ . Then the discriminant of this polynomial  $\Delta \neq 0$  in a neighborhood  $'V$  of  $'0$  (see subsection 23), and the set  $E = \{z \in 'V : \Delta'(z) = 0\}$  is a complex hypersurface in  $'V$ .

For  $'z \in 'V \setminus E$  all the roots of the equation  $P'(z, z_n) = 0$  are simple; we

denote by  $z_n^{(\mu)}(z)$  ( $\mu = 1, \dots, k_j$ ) those roots for which  $(z, z_n^{(\mu)}) \in A_j$ , and we construct a polynomial

$$p_j(z) = \prod_{\mu=1}^{k_j} (z_n - z_n^{(\mu)}(z)) = z_n^{k_j} + c_1(z) z_n^{k_j-1} + \dots + c_{k_j}(z).$$

Since  $\frac{\partial P}{\partial z_n}(z, z_n^{(\mu)}) \neq 0$ , then by the implicit function theorem from subsection 9 the roots  $z_n^{(\mu)}$  are holomorphic in a sufficiently small neighborhood of  $z$ , and they obviously admit an analytic continuation along any path in  $V \setminus E$ . However in going around certain closed paths the finite value may not be the same as the original value, and may pass to the value of another root. Such permutations do not change the values of symmetric functions of these roots, so that the latter remain single-valued, and hence, are holomorphic in  $V \setminus E$ . Hence, the coefficients of the polynomial  $p_j$ , which are elementarily expressed by means of symmetric functions of its roots, are also holomorphic in  $V \setminus E$ .

Furthermore, it is clear that the roots  $z_n^{(\mu)}$ , and hence, the coefficients of  $p_j$  remain bounded as  $z \rightarrow E$ . Since  $E$  is an analytic set, then by a theorem which will be proved in the following chapter (see Theorem 3 in subsection 32) it follows that these coefficients admit analytic continuations in the whole neighborhood  $V$ . Since the set  $A_j$  is connected, then under this analytic continuation all its points are obtained and  $p_j(z) = 0$  is the equation of  $\bar{A}_j$  everywhere in  $V$ . The analyticity of the set  $\bar{A}_j$  is proved, and hence the whole assertion is proved.

This assertion does not hold only for hypersurfaces, but also for sets of arbitrary dimension.

**THEOREM 4.** *An analytic set  $A$  in a domain  $D$  is irreducible if and only if the set  $A^0$  of its regular points is connected; in general, the closures in  $D$  of the connected components of  $A^0$  are irreducible analytic sets.*

However, in the general case the proof is complicated, and we do not give it.<sup>(35)</sup> From this theorem we get

**THEOREM 5.** *Any analytic set  $A$  in the domain  $D$  is represented as a union of irreducible analytic sets in this domain.*

For the proof it suffices to consider the connected components of the set of regular points of  $A$  and to take their closures; they will be the irreducible components of  $A$ .

\* Prove that the set  $A = \{z \in \mathbb{C}^2 : z_1^3 + z_1^2 - z_2^2 = 0\}$  is irreducible, but is reducible at the point 0. (HINT:  $A$  is the image of  $\mathbb{C}$  under the mapping  $\zeta \rightarrow (\zeta^2 - 1, \zeta(\zeta^2 - 1))$ ; the inverse image of  $A^0$  is connected, but  $(A \cap U)^0$ , where  $U = \{|z_1| < 1, |z_2| < 1\}$ , is not connected. \*)

<sup>(35)</sup> See §§5.3 and 5.4 of Chirka's book cited in the previous footnote.

To conclude we give two theorems which can be considered as a generalization of the uniqueness theorem for functions of one variable.

**THEOREM 6.** *If an analytic set  $A$  in a domain  $D \subset \mathbb{C}^n$  is zero-dimensional, i.e., has no connected components other than points, then it cannot have limit points inside  $D$ .*

◀ We shall prove the theorem by induction on  $n$ . For  $n = 1$  it is true, since it is the same as the uniqueness theorem for functions of one variable. We assume that it is true for sets belonging to  $\mathbb{C}^{n-1}$ , but false for sets belonging to  $\mathbb{C}^n$ . Then in  $D \subset \mathbb{C}^n$  there is a set  $A$  that satisfies the hypotheses of the theorem and has a limit point  $a \in D$ . Suppose that in a neighborhood of  $a$  the set  $A$  is given by the equations

$$f_1(z) = \cdots = f_m(z) = 0; \quad (5)$$

since it is zero-dimensional, then  $m > 1$  for  $n > 1$ . Moreover,  $A$  cannot contain the line  $'z = 'a$ , so that not all the functions  $f_j('a, z_n) \equiv 0$ : suppose  $f_j('a, z_n) \neq 0$  for  $j = 1, \dots, l$  and  $f_j('a, z_n) \equiv 0$  for  $j = l+1, \dots, m$ . Replacing (5) by the equivalent system of equations  $g_j(z) = 0$ , where  $g_j = f_j$  for  $j = 1, \dots, l$  and  $g_j = f_j + f_1$  for  $j > l$ , we will obtain the fact that all the  $g_j('a, z_n) \neq 0$ . After this we can apply the preparation theorem and give  $A$  locally by equations with Weierstrass polynomials:

$$P_1('z, z_n) = \cdots = P_m('z, z_n) = 0. \quad (6)$$

Without loss of generality we may assume that  $A$  contains a sequence of points  $('a^\nu, a_n^\nu)$ , where all the  $'a^\nu$  ( $\nu = 1, 2, \dots$ ) are distinct.

We consider the resultant of the polynomial  $P_m$  and the linear combination  $\lambda_1 P_1 + \cdots + \lambda_{m-1} P_{m-1}$  with complex coefficients. This is a polynomial in the variables  $\lambda_j$  with coefficients that are holomorphic in a neighborhood of  $'a$ ; in the usual notation it has the form

$$R('z, \lambda) = \sum_{k \in K} Q_k('z) \lambda^k, \quad (7)$$

where  $K$  is some set of multi-indices  $k = (k_1, \dots, k_{m-1})$ . If for a fixed  $'z$  there is a point  $('z, z_n)$  at which all the  $P_j = 0$ , then  $R('z, \lambda) = 0$  at that point for all  $\lambda \in \mathbb{C}^{m-1}$ . Conversely, if for some  $'z$  the resultant  $R('z, \lambda) = 0$  for all  $\lambda \in \mathbb{C}^{m-1}$ , then there is a common root  $z_n$  of all the polynomials  $P_j('z, z_n)$  (in fact, if for each root  $z_n^{(\mu)}$  of the polynomial  $P_j('z, z_n)$  there is a  $P_j$  such that  $P_j('z, z_n^{(\mu)}) \neq 0$ , then  $P_m$  and the linear combination  $\lambda_1 P_1 + \cdots + \lambda_{m-1} P_{m-1}$  for certain  $\lambda$  do not have common roots, and hence,  $R('z, \lambda) \neq 0$  for these  $\lambda$ ).

Thus, the projection of  $A$  into the space  $\mathbb{C}^{n-1}$  close to the point  $'a$  is described by the condition  $R('z, \lambda) = 0$  for all  $\lambda \in \mathbb{C}^{m-1}$ , equivalent to the

equations  $Q_k('z) = 0$  for  $k \in K$ , i.e., is an analytic set. This set satisfies the hypotheses of the theorem and has  $'a$  as its limit point. We are thus led to a contradiction with the induction hypothesis. ►

**THEOREM 7.** *An analytic set in a domain  $D \subset \mathbb{C}^n$  either has points as close to the boundary  $\partial D$  as desired or it consists of a finite number of points.*

◀ We need to prove that any analytic set  $A$  in  $D$  is finite if it is compactly contained in  $D$ . The set  $A$  is compactly contained in some polydisc  $U^n = \{\|z\| < R\}$ ; we will prove its finiteness by again using induction on  $n$ . For  $n = 1$  the assertion follows from the uniqueness theorem, and we assume that it is true for dimension  $n - 1$ .

We denote by  $\pi: z \rightarrow 'z$  the projection of  $\mathbb{C}^n$  into  $\mathbb{C}^{n-1}$ ; let  $'A = \pi(A)$  and let  $'z^0$  be an arbitrary point of  $'A$ . The set  $A$  has a finite number of points with projection  $'z^0$ , since  $A \cap \{z = 'z^0\}$  is a compact analytic set on a complex line, and hence, is finite. We denote these points by  $z^j = ('z^0, z_n^j)$  and we take disjoint neighborhoods  $U_j$  of them that project into the same neighborhood  $'U \ni 'z^0$ . These neighborhoods can be taken so small that in each of them

$$A \cap U_j = \{z \in U_j : f_1(z) = \cdots = f_m(z) = 0\}, \quad (8)$$

where all the  $f_\mu \in \mathcal{O}(U_j)$ .

Since  $A$  does not contain the line  $'z = 'z^0$ , then, repeating the argument given in the proof of the preceding theorem, we can write  $A \cap U_j$  by the system (6) of equations with Weierstrass polynomials, and we see that the projection  $\pi(A \cap U_j)$  is an analytic set in  $'U$ .<sup>(36)</sup> The projection into  $'U$  of the whole set  $A$  is a finite union of the  $\pi(A \cap U_j)$  for different  $j$  and hence, it also is an analytic set. We have proved that  $'A = \pi(A)$  is an analytic set, and since it follows from the condition  $A \subset \subset U^n$  that  $'A \subset \subset \pi(U^n)$ , then by the induction hypothesis  $'A$  is finite. But then  $A$  is also a finite set. ►

**25. Local structure.** We start with the simplest case of analytic sets of codimension 1, i.e., complex hypersurfaces. Such a set is locally given as the set of zeros of a holomorphic function, and among the functions giving the set  $A$  in a neighborhood of a point  $a$  there is a distinguished one, called the *defining function* of  $A$  at  $a$ . This is a function  $f$ , holomorphic in a neighborhood  $U \ni a$ , such that: (1)  $A \cap U = \{z \in U : f(z) = 0\}$  and (2) any function  $g \in \mathcal{O}(U)$ , equal to 0 on  $A$ , is divisible by  $f$ .

The existence of local defining functions is easy to prove. Let  $f$  be some function holomorphic at the point  $a$ , giving the set  $A$  in the neighborhood  $U$ . Decomposing  $f$  in the product (14) of subsection 23, in this product we choose one irreducible factor at  $a$  from each group of identical factors and

<sup>(36)</sup> Here we assume that  $m > 1$ ; in the case  $m = 1$  it is obvious that  $\pi(A \cap U_j) = 'U$  is an analytic set of codimension 0.

from them we construct a function  $\tilde{f} = f_1 \cdots f_l$ . The equation  $\tilde{f}(z) = 0$  obviously gives the same set  $A$  in the neighborhood  $U$ , and by Theorem 4 of subsection 23 any holomorphic function  $g$  at the point  $a$ , equal to zero on  $A$ , is divisible by each irreducible factor  $f_j$ , and hence also by  $\tilde{f}$ . Thus,  $\tilde{f}$  is a defining function of  $A$  at  $a$ . By the same Theorem 4 of subsection 23 it also follows that the defining function is unique up to a nonvanishing factor.

The local structure of complex hypersurfaces is clear from the Weierstrass preparation theorem. Without loss of generality we assume that in a neighborhood  $U$  of a point  $a \in A$  this set is given by a defining function  $f$  such that  $f'(z, z_n) \neq 0$ ; geometrically this means that  $A$  does not contain the complex line  $\{z = a\}$ . By the preparation theorem the function  $f$  can be replaced by its Weierstrass polynomial  $P$  at  $a$ , and since  $f$  is a defining function, then all the irreducible factors of  $P$  are distinct. By Theorem 3 of subsection 23 the discriminant  $\Delta$  of this polynomial is not identically equal to 0 in the projection  $'U$  of the neighborhood  $U$ , and hence, the set  $E = \{z \in 'U : \Delta(z) = 0\}$  is either a complex hypersurface in  $'U$  or empty.

Let  $k = \deg P > 1$ ; then for any point  $'z \in 'U \setminus E$  the equation  $P(z, z_n) = 0$  has  $k$  distinct solutions  $z_n^j(z)$ , and all these solutions remain distinct and continuous (even holomorphic) in a neighborhood of  $'z$  that does not contain points of  $E$ . Thus, under our assumptions the set  $A$  is a  $k$ -sheeted covering of  $'U \setminus E$ . As  $'z$  approaches  $E$  some of the roots  $z_n^j(z)$  coalesce, so that  $\pi^{-1}(E)$  is the branch set of the projection  $\pi: A \cap U \rightarrow 'U$ , and this set is, as is said, a branched (or ramified) covering of  $'U$ . But if  $k = \deg P = 1$ , then the discriminant set  $E$  is empty, and  $A \cap U$  is the graph of the holomorphic function  $z_n = z_n(z)$  over  $'U$ , i.e., is a complex manifold.

This analysis shows that over  $'U \setminus E$  the points of the hypersurface  $A \cap U$  are regular, so that the discriminant set  $E$  contains the projections of all the critical points of  $A \cap U$ . However,  $E$  can also contain other points: for example, for the set  $A = \{z \in \mathbb{C}^2 : z_2^2 - z_1 = 0\}$  the origin is a regular point, and its projection  $z_1 = 0$  coincides with the discriminant set  $E$  (for  $z_1 = 0$  the equation  $z_2^2 - z_1 = 0$  has a multiple root).

It is easy to obtain an analogous result when the analytic set  $A \subset \mathbb{C}^n$  has codimension 2 and is locally given in a neighborhood  $U \ni a$  by two equations  $f(z) = g(z) = 0$ , where both functions  $f$  and  $g$  are defining functions for the corresponding hypersurfaces. Choosing the direction of the  $z_n$  axis so that  $f'(a, z_n) \neq 0$  and  $g'(a, z_n) \neq 0$ , we can replace these functions by their Weierstrass polynomials  $P$  and  $Q$  at  $a$ . Then it follows from what was said in subsection 24 that the projection  $'A = \pi_1(A)$  of the set  $A$  into a neighborhood  $'U \subset \mathbb{C}^{n-1}$  is given by the equation  $R(z) = 0$ , where  $R$  is the resultant of  $P$  and  $Q$ , and  $R \neq 0$ , since then  $\text{codim } A = 1$ . Thus,  $'A$  is an analytic hypersurface in  $'U$  and by the foregoing we can choose the

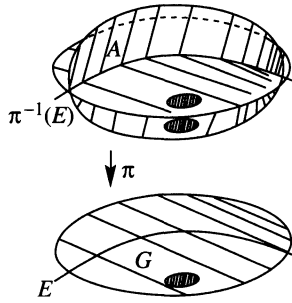

FIGURE 26

direction of the  $z_{n-1}$  axis so that the projection  $\pi_2: A \cap U \rightarrow U \subset \mathbb{C}^{n-2}$  will be a branched covering. But then the projection  $\pi = \pi_2 \circ \pi_1: A \cap U \rightarrow U$  is also a branched covering.

In the general case we say that an analytic set  $A$  in a domain  $D \subset \mathbb{C}^n$  is a *branched covering* (Figure 26) over a domain  $G \subset \mathbb{C}^m$  if there exists an analytic set  $E \subset G$  (different from  $G$ ) such that the projection  $\pi: \mathbb{C}^n \rightarrow \mathbb{C}^m$  maps  $A$  PROPERLY<sup>(37)</sup> onto  $G$ , and the restriction of  $\pi$  onto  $A \setminus \pi^{-1}(E)$  is a covering of finite multiplicity over  $G \setminus E$  (from this it follows that  $\dim A = m$ ). Also in the general case one can prove the following

**THEOREM 1.** *Any analytic set  $A \subset \mathbb{C}^n$  in a sufficiently small neighborhood  $U$  of each of its points  $a$  is a branched covering over a neighborhood of the projection of  $a$  into some subspace  $\mathbb{C}^m \subset \mathbb{C}^n$ ,  $m = \dim A$ .*

The proof of this theorem is rather complicated and we omit it (see §4 of Chirka's book cited earlier).

**REMARK.** One of the difficulties in the proof of Theorem 1 in the general case is that an analytic set  $A$  of codimension  $m > 1$  in a domain  $D$  may even locally not always be given by  $m$  equations. Consider, for example, in  $\mathbb{C}^6$  with coordinates  $(z_1, z_2, z_3, w_1, w_2, w_3)$  the cone  $C$  defined by the system of equations

$$z_1 w_2 = z_2 w_1, \quad z_1 w_3 = z_3 w_1, \quad z_2 w_3 = z_3 w_2 \tag{1}$$

in a neighborhood of the origin. At the points of  $C$  at which none of the coordinates is equal to 0, one of the equations is a consequence of the other two, i.e.,  $\text{codim } C = 2$  there, and since the set of such points is dense in  $C$ , then by the definition of dimension from subsection 24  $\text{codim } C = 2$  everywhere. But at the points of  $C$ , where  $z_1 = w_1 = 0$  (or  $z_2 = w_2 = 0$  or  $z_3 = w_3 = 0$ ), two of these equations become trivial, and the third is not, so that none of the equations can be dropped. (A rigorous proof of the fact that  $C$  cannot be given by two equations is rather complicated.)

It is clear that something like this can happen only in a neighborhood of a critical point of the set: in a neighborhood of a regular point a set of codimension  $k$  can be given locally by  $k$  equations.

A further idea about the local structure of an analytic set  $A$  in a neighborhood of a critical point  $a$  of  $A$  is the notion of the *tangent cone*  $C_a(A)$

<sup>(37)</sup> A mapping  $f: D \rightarrow G$  is said to be *proper* if for any compact subset  $K \subset G$  the inverse image  $f^{-1}(K)$  is a compact subset of  $D$ .

at this point. This is the set of vectors  $v$  that are limits of sequences  $\lambda_j v^j$ , where the  $v^j$  are vectors joining  $a$  with points  $z^j \in A \setminus \{a\}$  and the  $\lambda_j$  are complex numbers, and  $z^j \rightarrow a$  (and hence  $\lambda_j \rightarrow \infty$  if  $v \neq 0$ ). In other words,  $C_a(A)$  is formed by the limit positions of the "secants"  $v^j = z^j - a$  as  $z^j \rightarrow a$ ; if  $a$  is a regular point of  $A$ , then  $C_a(A)$  coincides with the tangent plane  $T_a(A)$ . It is obvious that if  $v \in C_a(A)$ , then we also have  $\lambda v \in C_a(A)$  for any  $\lambda \in \mathbb{C}$ , so that  $C_a(A)$  consists of complex lines, i.e., is actually a cone with vertex at the point  $a$ .

For complex hypersurfaces the equation of the tangent cone can be written immediately:

**THEOREM 2.** *Suppose that in a neighborhood of a point  $a$  the function  $f$ , giving the complex hypersurface  $A$ , is expanded in a series in homogeneous polynomials of  $z - a$ :*

$$f(z) = \sum_{\nu=l}^{\infty} P_{\nu}(z - a). \quad (2)$$

Then the equation of the tangent cone  $C_a(A)$  will be

$$P_l(z - a) = 0, \quad (3)$$

where  $P_l$  is the lowest nonzero polynomial in the expansion (2).

◀ Without loss of generality we assume that  $a = 0$ . Using the fact that  $P_{\nu}$  is a homogeneous polynomial of degree  $\nu$  and that  $z^j \in A$ , from (2) we will obtain

$$0 = f(z^j) = \frac{1}{\lambda_j^l} P_l(\lambda_j z^j) + \frac{1}{\lambda_j^{l+1}} P_{l+1}(\lambda_j z^j) + \dots$$

Hence, since for any  $v = \lim_{j \rightarrow \infty} \lambda_j v^j \in C_a(A) \setminus \{a\}$  we have  $\lambda_j \rightarrow \infty$ , in the limit we conclude that  $P_l(v) = 0$ .

Conversely, suppose  $P_l(v) = 0$ . We choose coordinates so that  $v = (v', 0)$ , where  $v' = (v_1, \dots, v_{n-1})$ ; since  $P_l(v', 0) = 0$ , then  $P_l(v', z_n) = \sum_{\nu=m}^l q_{\nu}(v') z_n^{\nu}$ , where  $m \geq 1$  and  $q_m(v') \neq 0$ , and hence, for fixed  $v'$  and  $|z_n| < 1$  we have

$$|P_l(v', z_n)| \geq |z_n|^m \left\{ |q_m| - \sum_{\nu=m+1}^l |q_{\nu}| |z_n|^{\nu} \right\} \geq a |z_n|^m \geq a |z_n|^l \quad (4)$$

with some constant  $a > 0$ . On the other hand, if we set  $g_l(z) = \sum_{\nu=l+1}^{\infty} P_{\nu}(z)$ , then for any  $\lambda \in \mathbb{C}$  and  $|z_n| < 1$  we have

$$|g_l(\lambda v', \lambda z_n)| = \left| \sum_{\nu=l+1}^{\infty} \lambda^{\nu} P_{\nu}(v', z_n) \right| \leq b |\lambda|^{l+1}. \quad (5)$$



We apply Rouché's theorem in the last variable to the function  $f = P_l + g_l$  with the remaining variables being fixed: take the circle  $\{|z_n| = r\}$ , where  $r^l = 2b|\lambda|/a$ ; on it, by (4) and (5) we have

$$|P_l(\lambda v', \lambda z_n)| \geq a|\lambda z_n|^l = 2b|\lambda|^{l+1} > |g_l(\lambda v', \lambda z_n)|,$$

and hence  $f(\lambda v', \lambda z_n)$  has at least one zero in the disc  $\{|z_n| < r\}$  (we have  $P_l(\lambda v', 0) = 0$ ). We now choose a sequence  $\lambda_j \rightarrow 0$  and, using what we have just proved, we construct a sequence  $z_n^j \in \{|z_n| < 2b|\lambda_j|/a\}$  and a sequence of points  $z^j = (\lambda_j v', \lambda_j z_n^j) \in A$ , converging to 0, and such that  $\lambda_j^{-1} z^j = (v', z_n^j) \rightarrow (v', 0) = v$ . This also means that  $v \in C_a(A)$ . ►

For higher codimensions the situation is different: for example, the tangent cone to the curve  $\{z \in \mathbb{C}^3 : z_1 + z_2^2 = 0, z_1 + z_3^3 = 0\}$  is the line  $\{z_1 = z_2 = 0\}$  at the point  $z = 0$ , while setting the lowest order terms to zero gives the hypersurface  $\{z_1 = 0\}$ . In the general case it is easy to prove (as in Theorem 2) that the tangent cone to an analytic set  $A$  is contained in the tangent cone at the point  $a$  to any complex hypersurface that contains  $A$ . Indeed,  $C_a(A)$  is the intersection of the tangent cones  $C_a(S)$  to all the complex hypersurfaces  $S \supset A$  (see §8.4 of Chirka's book cited previously).

Thus, if the analytic set  $A$  is given in a neighborhood of a point  $a$  by the equations

$$f_1(z) = \dots = f_k(z) = 0, \quad (6)$$

then the tangent cone  $C_a(A)$  only belongs to the set describable by the lowest nonzero terms of the expansion of  $f_j$  in a series of homogeneous polynomials in  $z - a$ :

$$P_{l_1}^1(z - a) = \dots = P_{l_k}^k(z - a) = 0. \quad (7)$$

And if (7) defines a set of dimension equal to  $\dim_a A = m$ , then this system will precisely describe  $C_a(A)$  (see Chirka's book cited above).

We also note that the tangent cone  $C_a(A)$  is a good approximation of the set  $A$  in a neighborhood of  $a$ , for example, in the sense that the distance between the intersections of  $A$  and  $C_a$  with the sphere  $\{|z - a| = r\}$  is  $o(r)$  as  $r \rightarrow 0$ . It is not difficult to deduce this property from the definition of the tangent cone.

## §9. Bundles and sheaves

We conclude the chapter by describing two more geometric concepts that play an important role in analysis.

**26. The concept of a bundle.** This concept is a generalization of the concept of covering, in which instead of a discrete space  $E$  (see the definition in subsection 20) we consider an arbitrary topological space.

**DEFINITION 1.** Consider a system of objects consisting of three topological

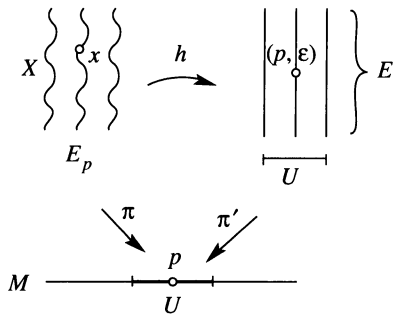

FIGURE 27

spaces:<sup>(38)</sup>  $X$  (the fiber space),  $M$  (the base),  $E$  (the space of the fibers), and a continuous mapping  $\pi: X \rightarrow M$  (the projection). This system is called a (fiber) bundle if for each point  $p \in M$  there exist a neighborhood  $U$  and a homeomorphism  $h: \pi^{-1}(U) \rightarrow U \times E$  such that the diagram in Figure 27 commutes, i.e., for any  $x \in \pi^{-1}(U)$ ,

$$\pi' \circ h(x) = \pi(x), \tag{1}$$

where  $\pi': U \times E \rightarrow U$  is the usual projection ( $\pi'(p, \varepsilon) = p$ ). Often for brevity we shall call the space  $X$  itself a bundle.

The inverse image  $\pi^{-1}(p) = E_p$  is called a fiber (or a stalk) of the bundle  $\pi: X \rightarrow M$ ; the mapping  $h$  (for fixed  $p$ ) establishes a homeomorphism of  $E_p$  onto the space  $E$ . The commutativity of the diagram means that the homeomorphism  $h: \pi^{-1}(U) \rightarrow U \times E$  is FIBERED, i.e., that it preserves the fibers (see Figure 27 and the analogous argument in subsection 20). Moreover, it follows from our definition that the bundle  $X$  is LOCALLY TRIVIAL: inside the limits of the neighborhood  $U$  (up to homeomorphism) it is structured as a product  $U \times E$ ; globally a bundle is not necessarily trivial, i.e., homeomorphic to the product  $M \times E$ .

DEFINITION 2. A section of a bundle  $\pi: X \rightarrow M$  in a domain  $D \subset M$  is a continuous mapping  $s: D \rightarrow X$  such that

$$\pi \circ s(p) \equiv p \text{ in } D. \tag{2}$$

Sections always exist LOCALLY: take a neighborhood  $U$  over which the bundle  $X$  is trivial, fix an element  $\varepsilon \in E$  and to each point  $p \in U$  associate the element  $s_\varepsilon(p) = h^{-1}(p, \varepsilon)$ . The mapping  $s_\varepsilon: U \rightarrow X$  is a section of  $X$  in  $U$ , since  $\pi \circ s_\varepsilon(p) = \pi' \circ h(s_\varepsilon(p)) = p$  for all  $p \in U$ . As we shall see from examples, GLOBAL sections  $s: M \rightarrow X$  do not exist for every bundle.

EXAMPLES.

1. The set of tangent vectors of length 1 to the two-dimensional sphere  $S^2$  forms a bundle with base  $S^2$  and fibers of circles (the ends of the tangent vectors at a point  $p \in S^2$ ). The

<sup>(38)</sup> As usual, these are Hausdorff and with a countable base of open sets.

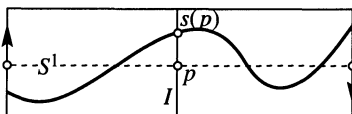

FIGURE 28

projection  $\pi$  puts in correspondence to each point  $x$  of a circle the center  $p$  of this circle. The sections of this bundle are the *vector fields* of unit tangent vectors, i.e., continuous functions which to each point of a domain  $D \subset S^2$  associate some unit vector. They exist in domains of the sphere different from  $S^2$  itself, and there are no global sections on all of  $S^2$  in view of a well-known theorem (which states that it is impossible to comb a hedgehog smoothly).

2. The MÖBIUS STRIP  $X$  is a rectangle, two opposite sides of which are identified after turning one over (Figure 28). This is a bundle whose base is  $S^1$  (the median of the rectangle with glued ends), and the fibers are intervals, say  $I = [-1, 1]$ . The projection  $\pi$  puts in correspondence to each point  $x$  of the interval  $p \in I$  the midpoint  $p$  of this interval. The global sections of the bundle are continuous functions  $s: S^1 \rightarrow X$ . This bundle is not globally trivial: it is not homeomorphic to the cylinder  $S^1 \times I$ .

3. Complex projective space  $\mathbb{C}P^n$  can be considered as the base of a bundle  $\pi: \mathbb{C}_*^{n+1} \rightarrow \mathbb{C}P^n$ ; the projection  $\pi$  associates to points  $z \in \mathbb{C}_*^{n+1} = \mathbb{C}^{n+1} \setminus \{0\}$  the equivalence classes  $[z]$  modulo the relation  $z' \sim z''$  if  $z' = \lambda z''$ , where  $\lambda \in \mathbb{C}_*$ . The fibers of this bundle are the sets  $\pi^{-1}([z]) = \{\lambda z\}$ , where  $z$  is some representative of the class  $[z]$  and  $\lambda$  runs through  $\mathbb{C}_*$ ; these sets are homeomorphic to  $\mathbb{C}_*$  (the complex line minus a point). Over the domains  $U_j = \{[z] \in \mathbb{C}P^n : z_j \neq 0\}$  of the standard covering of  $\mathbb{C}P^n$  the bundle is trivial:  $\pi^{-1}(U_j)$  is homeomorphic to  $\mathbb{C}^n \times \mathbb{C}_*$ , however it is not globally trivial.

As we saw in subsection 1, instead of  $\mathbb{C}_*^{n+1}$  we can take the unit sphere  $S^{2n+1}$ ; the fibers of the bundle  $\pi: S^{2n+1} \rightarrow \mathbb{C}P^n$  will then be the circles  $\{|\lambda| = 1\} \subset \mathbb{C}_*$ .

A very important class of bundles is the class of *smooth vector bundles*, which are characterized by the following additional conditions: (1) the base  $M$  of the bundle is a smooth manifold, say of dimension  $\dim M = m$ , and the fiber space is the finite-dimensional vector space  $\mathbb{R}^n$ ; (2) the bundle is trivial over the domains of the charts  $U_\alpha$  of the atlas of  $M$ , and the diffeomorphism  $h_\alpha: \pi^{-1}(U_\alpha) \rightarrow U_\alpha \times \mathbb{R}^n$  for any fixed point  $p \in U_\alpha$  is an isomorphism of the linear space  $V_p = \pi^{-1}(p)$  onto  $\mathbb{R}^n$ .

If  $\pi: V \rightarrow M$  is a vector bundle, then for charts  $(U_\alpha, \varphi_\alpha)$ ,  $(U_\beta, \varphi_\beta)$  with nonempty intersection  $U_{\alpha\beta} = U_\alpha \cap U_\beta$ , besides the compatibility relations  $\varphi_{\alpha\beta} = \varphi_\beta \circ \varphi_\alpha^{-1}$  of the manifold  $M$  (diffeomorphism of domains of the space  $\mathbb{R}^m$ ) there arises another mapping

$$h_{\alpha\beta} = h_\beta \circ h_\alpha^{-1}, \quad (3)$$

which for fixed  $p \in U_{\alpha\beta}$  is an isomorphism of the space  $\mathbb{R}^n$ , i.e., a nondegenerate linear transformation (Figure 29). For fixed  $p \in U_{\alpha\beta}$  and any vector  $v \in V_p$  the transformation (3) can be written in the form

$$\xi^\beta = h_{\alpha\beta}(p)\xi^\alpha, \quad (4)$$

where  $\xi^\alpha = h_\alpha(v)$  and  $\xi^\beta = h_\beta(v)$  are column vectors, and  $h_{\alpha\beta}(p)$  is a nondegenerate  $n \times n$  matrix. Such matrices are called the *transition matrices*

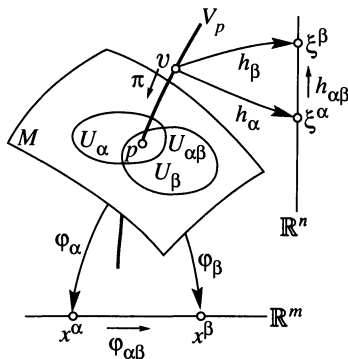

FIGURE 29

of the vector bundle  $V$ ; they are matrix functions defined in the intersections  $U_{\alpha\beta}$  and they characterize the bundle. For  $n = 1$  vector bundles are called *line bundles*, and the role of the transition matrices is played by *transition functions*  $h_{\alpha\beta}$ , which are smooth nonvanishing functions in  $U_{\alpha\beta}$ .

An arbitrary vector bundle  $V$  with  $n$ -dimensional fibers over an  $m$ -dimensional manifold  $M$  is itself a manifold of dimension  $m + n$ . The local coordinates on  $V$  over a domain  $U_\alpha \subset M$  can be taken as  $(x^\alpha, \xi^\alpha)$ , where  $x^\alpha = \varphi_\alpha(p)$  and  $\xi^\alpha = h_\alpha(v)$  ( $p \in U_\alpha$ ,  $v \in V_p$ ), and the compatibility relations are mappings  $(\varphi_{\alpha\beta}, h_{\alpha\beta})$  of domains of  $\mathbb{R}^{m+n}$ .

The concept of vector bundle extends without changes to complex manifolds  $M$ , where the fiber space is taken to be  $\mathbb{C}^n$ . In this case we can distinguish the class of *holomorphic bundles* as bundles with transition matrices consisting of holomorphic functions. For holomorphic bundles we can consider holomorphic sections in addition to continuous and smooth sections.

**EXAMPLE 4.** In subsection 16 we considered the family  $L_{\mathbb{E}}$  of disjoint complex lines in  $\mathbb{P}^3$ , which is parameterized by the points  $Z$  of the real four-dimensional plane  $\mathbb{E} = \{z_{00} = \bar{z}_{11}, z_{01} = -\bar{z}_{10}\}$  of complex Minkowski space  $M^c$ . This parameterization is realized by the Penrose transformation  $p: \mathbb{E} \rightarrow L_{\mathbb{E}}$ , associating a line  $l \in L_{\mathbb{E}}$  to points  $Z \subset \mathbb{E}$ .

The lines belonging to  $L_{\mathbb{E}}$  are defined by the points  $w$  and  $\nu(w)$ , where  $\nu$  is the anti-involution and  $|w_0|^2 + |w_1|^2 \neq 0$ . If we waive the last restriction, then it will be necessary to pass from  $M^c$  to its compactification  $\tilde{M}^c$ , where the points are represented by  $4 \times 2$  matrices  $\tilde{Z}$ . The Penrose transformation is defined on  $\tilde{M}^c$  and we pass to the compactification  $L_{\tilde{\mathbb{E}}}$  of the family  $L_{\mathbb{E}}$ . The compactified family  $L_{\tilde{\mathbb{E}}}$  is a bundle of  $\mathbb{P}^3$  into complex lines with base  $\tilde{\mathbb{E}}$ , the compactification of the plane  $\mathbb{E}$ ; the projection here is the inverse Penrose transformation  $p^{-1}$ . In subsection 16 we considered this bundle only over the affine part of  $\tilde{\mathbb{E}}$ , but it is not difficult to describe it in the other charts of the Grassmannian  $G(3, 1)$ , to which  $\tilde{M}^c$  belongs. The bundle  $L_{\tilde{\mathbb{E}}}$  is a holomorphic line bundle.

**27. The tangent and cotangent bundles.** We have already written down equations for the tangent planes (real and complex) to submanifolds of  $\mathbb{C}^n$ . However, it is useful to have a general abstract definition of a tangent space to an arbitrary manifold.

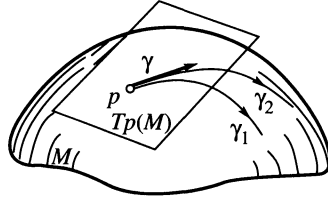

FIGURE 30

First we consider the case of real manifolds  $M$ . We fix a point  $p \in M$  and denote by  $\mathcal{F}_p$  the set of germs of smooth real functions at this point (i.e., equivalence classes modulo the relation  $f_1 \sim f_2$  if  $f_1 \equiv f_2$  in some neighborhood of  $p$ ). We denote by  $I$  the interval  $[0, 1] \subset \mathbb{R}$  and on the set of smooth paths  $\gamma: I \rightarrow M$  with starting point  $\gamma(0) = p$  we introduce an equivalence relation:  $\gamma_1 \sim \gamma_2$  if

$$\frac{d}{dt} f \circ \gamma_1(t)|_{t=0} = \frac{d}{dt} f \circ \gamma_2(t)|_{t=0} \quad \text{for all } f \in \mathcal{F}_p;$$

we denote an equivalence class modulo this relation by  $\gamma$ . It can be represented geometrically as a tangent vector (Figure 30), but it is more convenient to identify  $\gamma$  with its action on germs, i.e., with the derivative of a germ in the direction  $\gamma$ . Therefore, we give

**DEFINITION 1.** A *tangent vector* to a manifold  $M$  at a point  $p$  is a functional  $v: \mathcal{F}_p \rightarrow \mathbb{R}$ , acting on a germ  $f \in \mathcal{F}_p$  according to the rule

$$v(f) = \frac{d}{dt} f \circ \gamma(t)|_{t=0} \quad \text{for all } \gamma \in \gamma. \quad (1)$$

The set  $T_p(M)$  of all tangent vectors to  $M$  at the point  $p$  is called the *tangent space* to  $M$  at  $p$ .

The space  $T_p(M)$  can be considered as a linear space over  $\mathbb{R}$  with the operations

$$(v + w)(f) = v(f) + w(f), \quad \lambda v(f) = v(\lambda f) \quad (2)$$

(here  $v, w \in T_p(M)$ ,  $f \in \mathcal{F}_p$ , and  $\lambda \in \mathbb{R}$ ), and any tangent vector  $v \in T_p(M)$ :

(a) is **LINEAR**, i.e.,  $v(\alpha f + \beta g) = \alpha v(f) + \beta v(g)$  for all  $\alpha, \beta \in \mathbb{R}$  and  $f, g \in \mathcal{F}_p$ ;

(b) is **LEIBNIZIAN**, i.e.,  $v(fg) = v(f)g(p) + f(p)v(g)$  for all  $f, g \in \mathcal{F}_p$ .

For fixed local coordinates  $x = \varphi$  on  $M$  in a neighborhood of  $p$ , we can find special tangent vectors  $\frac{\partial}{\partial x_\nu}$  ( $\nu = 1, \dots, n = \dim M$ ) in  $T_p(M)$ , which act on germs  $f \in \mathcal{F}_p$  according to the rule

$$\frac{\partial}{\partial x_\nu}(f) = \frac{\partial}{\partial x_\nu} f \circ \varphi^{-1}|_{\varphi(p)} \quad (3)$$

(as before  $x = \varphi(p)$  and  $x_\nu$  are the coordinates of  $x$ ).

**THEOREM 1.** *The vectors  $\frac{\partial}{\partial x_\nu}$  ( $\nu = 1, \dots, n$ ) form a basis of the linear space  $T_p(M)$ .*

◀ a) Any vector  $v \in T_p(M)$  is represented in the form

$$v = \sum_{\nu=0}^n \alpha_\nu \frac{\partial}{\partial x_\nu} \quad (4)$$

with certain constants  $\alpha_\nu$ . To prove this we shall write  $p_0$  instead of  $p$  and assume, without loss of generality, that  $\varphi(p_0) = 0$ .

We shall make use of the fact that for any smooth function  $F$  in the ball  $B = \{x \in \mathbb{R}^n : |x| < 1\}$  there exist smooth functions  $g_\nu$  in  $B$  such that  $g_\nu(0) = \frac{\partial F}{\partial x_\nu}(0)$  and for all  $x \in B$

$$F(x) - F(0) = \sum_{\nu=1}^n x_\nu g_\nu(x). \quad (5)$$

In fact, by the chain rule for differentiating composite functions we have

$$F(x) - F(0) = \int_0^1 \frac{d}{dt} F(tx) dt = \sum_{\nu=1}^n x_\nu \int_0^1 \frac{\partial F(tx)}{\partial x_\nu} dt,$$

and we can set  $g_\nu(x) = \int_0^1 \frac{\partial F(tx)}{\partial x_\nu} dt$ .

Applying (5) to the function  $F(x) = f \circ \varphi^{-1}(x)$ , we obtain

$$f \circ \varphi^{-1}(x) - f \circ \varphi^{-1}(0) = \sum_{\nu=1}^n x_\nu g_\nu(x),$$

or

$$f(p) - f(p_0) = \sum_{\nu=1}^n \varphi_\nu(p) g_\nu \circ \varphi(p), \quad (6)$$

where  $g_\nu(0) = \frac{\partial}{\partial x_\nu} f \circ \varphi^{-1}(0) = \frac{\partial}{\partial x_\nu} (f)$ . By properties (a) and (b) of tangent vectors it follows from (6) that

$$v(f) - v(f(p_0)) = \sum_{\nu=1}^n v(\varphi_\nu) g_\nu(0) + \sum_{\nu=1}^n \varphi_\nu(p_0) v(g_\nu \circ \varphi),$$

and since the value of a tangent vector on a constant is zero, then  $v(f(p_0)) = 0$  and, moreover, all the  $\varphi_\nu(p_0) = 0$ , since  $\varphi(p_0) = 0$ . Thus,

$$v(f) = \sum_{\nu=1}^n v(\varphi_\nu) \frac{\partial}{\partial x_\nu} (f) \quad (7)$$

for all  $f \in \mathcal{F}_p$ . This gives us (4) with the constants  $\alpha_\nu = v(\varphi_\nu)$ .

b) The vectors  $\frac{\partial}{\partial x_\nu}$  ( $\nu = 1, \dots, n$ ) are linearly independent. In fact, it follows from (3) that  $\frac{\partial}{\partial x_\nu} (\varphi_\mu) = \delta_{\mu\nu}$  (the Kronecker symbol, equal to 0 for  $\mu \neq \nu$ , and to 1 for  $\mu = \nu$ ). Therefore, if  $\sum_{\nu=1}^n c_\nu \frac{\partial}{\partial x_\nu} (f) = 0$  for all  $f \in \mathcal{F}_p$ , then, setting  $f = \varphi_\mu$  in particular, we find that  $c_\mu = 0$  ( $\mu = 1, \dots, n$ ). ▶

COROLLARY.  $\dim T_p(M) = \dim M$ .

The *cotangent space* to a manifold  $M$  at a point  $p$  is the dual space  $T_p^*(M)$  to  $T_p(M)$ , i.e., the set of all linear functions on  $T_p(M)$ . From (2) we see that  $v(f)$  for a fixed germ  $f$  is an  $\mathbb{R}$ -linear function of  $v$ . This function

$$v(f) = df(v) \quad (8)$$

is called the *differential* of the germ  $f \in \mathcal{F}_p$ ; the cotangent space  $T_p^*(M)$  consists of these differentials. In new coordinates formula (7) can be rewritten as

$$df(v) = \sum_{\nu=1}^n \frac{\partial}{\partial x_\nu}(f) dx_\nu(v), \quad (9)$$

from which we see that for fixed local coordinates the functions  $dx_\nu$  ( $\nu = 1, \dots, n$ ) form a basis of  $T_p^*(M)$ ; since  $dx_\mu(\frac{\partial}{\partial x_\nu}) = \delta_{\mu\nu}$ , this basis is dual to the basis (3). Obviously  $\dim T_p^*(M) = \dim T_p(M)$ .

We now consider the case of a COMPLEX  $n$ -dimensional manifold  $M$ . Considering it as a  $2n$ -dimensional real manifold and germs of REAL functions on it, in the tangent space  $T_p(M)$  we can formally introduce, instead of the basis vectors  $\frac{\partial}{\partial x_\nu}, \frac{\partial}{\partial y_\nu}$ , linear combinations of them:

$$\frac{\partial}{\partial z_\nu} = \frac{1}{2} \left( \frac{\partial}{\partial x_\nu} - i \frac{\partial}{\partial y_\nu} \right), \quad \frac{\partial}{\partial \bar{z}_\nu} = \frac{1}{2} \left( \frac{\partial}{\partial x_\nu} + i \frac{\partial}{\partial y_\nu} \right), \quad \nu = 1, \dots, n.$$

Then each tangent vector  $v \in T_p(M)$  can be represented in the form

$$v = \sum_{\nu=1}^n \left( \alpha_\nu \frac{\partial}{\partial z_\nu} + \beta_\nu \frac{\partial}{\partial \bar{z}_\nu} \right), \quad (10)$$

where all the  $\beta_\nu = \bar{\alpha}_\nu$ ; the real dimension of  $T_p(M)$  is equal to  $2n$ .

But if on  $M$  we consider germs of smooth COMPLEX functions  $f$ , defining tangent vectors for them by the same formula (1), then instead of  $T_p(M)$  we obtain a linear space  $\mathfrak{X}_p(M)$  over the field  $\mathbb{C}$ , whose *complex* dimension is equal to  $2n$ . A basis of  $\mathfrak{X}_p(M)$  is formed by the tangent vectors  $\frac{\partial}{\partial z_\nu}, \frac{\partial}{\partial \bar{z}_\nu}$  ( $\nu = 1, \dots, n$ ), and in formula (10)  $\alpha_\nu$  and  $\beta_\nu$  are arbitrary complex numbers. The dual space  $\mathfrak{X}_p^*(M)$  to  $\mathfrak{X}_p(M)$  consists of the complex functions

$$df = \sum_{\nu=1}^n \left( \frac{\partial f}{\partial z_\nu} dz_\nu + \frac{\partial f}{\partial \bar{z}_\nu} d\bar{z}_\nu \right) \quad (11)$$

on  $\mathfrak{X}_p(M)$ , and its basis  $dz_\nu, d\bar{z}_\nu$  is dual to the basis  $\frac{\partial}{\partial z_\nu}, \frac{\partial}{\partial \bar{z}_\nu}$ .

On a complex manifold  $M$  it is natural to consider germs of HOLOMORPHIC functions  $f \in \mathcal{O}_p$ ; then a basis of the tangent space, which we denote by  $T_p^c(M)$ , will be given by the vectors  $\frac{\partial}{\partial z_\nu}$  ( $\nu = 1, \dots, n$ ), and a basis of the dual space (consisting of the  $\mathbb{C}$ -linear functions) by the differentials  $dz_\nu$ . The complex dimension of both these spaces is equal to  $\dim_{\mathbb{C}} M = n$ .

We return to the case when  $M$  is a real submanifold of  $\mathbb{C}^n$  of dimension  $m$ , which is locally, in a neighborhood  $U$  of a point  $a$ , given by the  $k = 2n - m$  equations  $\varphi_\mu(z) = 0$ , where  $\varphi_\mu \in C^1(U)$  are real functions and  $\text{rank}\left(\frac{\partial\varphi_\mu}{\partial z_\nu}, \frac{\partial\varphi_\mu}{\partial \bar{z}_\nu}\right) = k$  (here  $\mu = 1, \dots, k$ , and  $\nu = 1, \dots, n$ ). The *real tangent space* to  $M$  at  $a$  consists of the vectors  $v \in \mathfrak{X}_a(M)$  such that  $v(\varphi_\mu) = 0$ :

$$T_a(M) = \left\{ v = \sum_{\nu=1}^n \left( a_\nu \frac{\partial}{\partial z_\nu} + \bar{a}_\nu \frac{\partial}{\partial \bar{z}_\nu} \right) : v(\varphi_1) = \dots = v(\varphi_k) = 0 \right\} \quad (12)$$

(the derivatives are taken at the point  $a$ ). To each  $v \in T_a(M)$  we associate a vector  $u = \sum_{\nu=1}^n a_\nu \frac{\partial}{\partial z_\nu}$ , so that  $v(\varphi) = 2\text{Re } u(\varphi)$  for any real function  $\varphi$  and, with an abuse of notation, we shall understand the real tangent space to be

$$T_a(M) = \left\{ u = \sum_{\nu=1}^n a_\nu \frac{\partial}{\partial z_\nu} : \text{Re } u(\varphi_1) = \dots = \text{Re } u(\varphi_k) = 0 \right\}. \quad (13)$$

A vector  $u \in T_a(M)$  will be called a *complex tangent vector* if we also have  $iu \in T_a(M)$ ; in this case we simultaneously have  $\text{Re } u(\varphi_\mu) = 0$  and  $\text{Re } iu(\varphi_\mu) = 0$ , i.e.,  $u(\varphi_\mu) = 0$ ,  $\mu = 1, \dots, k$ . The set of such vectors

$$T_a^c(M) = \left\{ u = \sum_{\nu=1}^n a_\nu \frac{\partial}{\partial z_\nu} : u(\varphi_1) = \dots = u(\varphi_k) = 0 \right\} \quad (14)$$

is the *complex tangent space* to  $M$  at  $a$ .

In particular, for real hypersurfaces  $S$  given locally by the equation  $\varphi(z) = 0$ , where  $\varphi \in C^1(U)$  and (for definiteness)  $\frac{\partial\varphi}{\partial z_n} \neq 0$ , a basis of the space  $T_a^c(S)$  is formed by the vectors

$$u_\nu = \frac{\partial\varphi}{\partial z_n} \Big|_a \frac{\partial}{\partial z_\nu} - \frac{\partial\varphi}{\partial z_\nu} \Big|_a \frac{\partial}{\partial z_n}, \quad \nu = 1, \dots, n-1. \quad (15)$$

In fact, it is obvious that  $u_\nu(\varphi) = 0$ , and these vectors are  $\mathbb{C}$ -linearly independent and the number of them is equal to the complex dimension of  $T_a^c(S)$ .

Up to now we have considered the tangent and cotangent spaces to the manifold  $M$  at a fixed point. We now pass to bundles, restricting ourselves for definiteness to real manifolds.

**DEFINITION 2.** The *tangent bundle* to a manifold  $M$  is a vector bundle, whose space is the disjoint union of the tangent spaces at the points  $p \in M$ :

$$T(M) = \bigcup_{p \in M} T_p(M); \quad (16)$$

the projection  $\pi: T(M) \rightarrow M$  associates to each tangent vector  $v \in T_p(M)$  its point of tangency  $p$ , and we shall now define the transition matrices.



If for an atlas  $\{(U_\alpha, x^\alpha)\}$  on  $M$  we choose the tangent vectors  $\partial/\partial x_\nu^\alpha$  ( $\nu = 1, \dots, n = \dim M$ ) as a basis in the fibers  $T_p(M)$ ,  $p \in U_\alpha$ , then in the intersections  $U_{\alpha\beta}$  we will have

$$\frac{\partial}{\partial x_\nu^\alpha} = \sum_{\mu=1}^n \frac{\partial x_\mu^\beta}{\partial x_\nu^\alpha} \frac{\partial}{\partial x_\mu^\beta}, \quad \nu = 1, \dots, n,$$

or in matrix notation

$$\frac{\partial}{\partial x^\alpha} = g_{\alpha\beta} \frac{\partial}{\partial x^\beta} \quad (17)$$

where

$$\frac{\partial}{\partial x^\alpha} = \left( \frac{\partial}{\partial x_1^\alpha}, \dots, \frac{\partial}{\partial x_n^\alpha} \right)^t$$

and analogously  $\partial/\partial x^\beta$  are column vectors ( $t$  denotes transposition), and  $g_{\alpha\beta} = (\partial x_\mu^\beta / \partial x_\nu^\alpha)$  is the Jacobi matrix of the coordinate change  $x^\alpha \rightarrow x^\beta$ . The matrices  $g_{\alpha\beta}$  are the transition matrices of the tangent bundle  $T(M)$ .

The sections of the bundle  $T(M)$  in a domain  $D \subset M$  are called *vector fields*; they are continuous functions which to each point  $p \in D$  associate some tangent vector  $v \in T_p(M)$ .

The *cotangent bundle*  $T^*(M)$  is defined completely analogously. Its transition matrices in the dual basis are the matrices which are the transposes of the Jacobi matrices  $g_{\alpha\beta}$ , since

$$dx_\nu^\alpha = \sum_{\mu=1}^n \frac{\partial x_\nu^\alpha}{\partial x_\mu^\beta} dx_\mu^\beta, \quad \nu = 1, \dots, n. \quad (18)$$

The smooth section of  $T^*(M)$  are *differential forms* of degree one, which locally in coordinate neighborhood  $U_\alpha$  have the form  $\omega = \sum_{\nu=1}^n f_\nu^\alpha dx_\nu^\alpha$ , where the  $f_\nu^\alpha$  are smooth functions of the point  $p \in U_\alpha$ . The condition that the sections into unions of intersecting coordinate neighborhoods be smooth obviously leads to the usual rule of variation of forms under a change of coordinates.

**28. The concept of a sheaf.** This concept is an algebraic modification of the concept of a covering, when some algebraic structure—groups, rings, or fields—is introduced into the fibers. For definiteness we consider the case of groups.

**DEFINITION 1.** We say that we are given a *sheaf of groups* over a topological space  $M$  (the *base*) if we are given another topological space  $\mathcal{S}$  (the *space of the sheaf*) and a locally homeomorphic mapping  $\sigma: \mathcal{S} \rightarrow M$  (the *projection*), where each fiber  $\mathcal{S}_p = \sigma^{-1}(p)$ ,  $p \in M$ , is a group and the group operation is CONTINUOUS in the topology of  $\mathcal{S}$ . The last requirement is understood as follows: let  $f, g, h \in \mathcal{S}_p$  and  $h = f + g$ ; then for any neighborhood  $\tilde{U}_h \subset \mathcal{S}$  of the point  $h$  on  $\mathcal{S}$  there are neighborhoods  $\tilde{V}_f$  and  $\tilde{V}_g$  of

$f$  and  $g$ , projected homeomorphically into the same neighborhood  $V_p$  of a point  $p \in M$  and such that, for any point  $q \in V_p$  and  $f_q \in \mathcal{S}_q \cap \tilde{V}_f$ ,  $g_q \in \mathcal{S}_q \cap \tilde{V}_g$ , the sum  $f_q + g_q \in \tilde{U}_h$ .

**DEFINITION 2.** A section of a sheaf  $\sigma: \mathcal{S} \rightarrow M$  in a domain  $D \subset M$  is a continuous mapping  $f: D \rightarrow \mathcal{S}$  such that the composition  $\sigma \circ f$  is the identity mapping in  $D$ . The set of all sections of a sheaf  $\mathcal{S}$  in a domain  $D$  will be denoted by the symbol  $\Gamma(D, \mathcal{S})$  or simply  $\mathcal{S}(D)$ .

Since the projection is a local homeomorphism sections always exist in a sufficiently small neighborhood of each point  $p \in M$ . Furthermore, if two sections  $f$  and  $g$  from  $\mathcal{S}(D)$  coincide at some point  $p \in D$ , then they coincide identically (in fact, the set  $E = \{p \in D : f(p) = g(p)\}$  is closed in  $D$  since  $f$  and  $g$  are continuous, and it is also open, since locally  $f$  and  $g$  are inverses of the projection  $\sigma$ ; since  $D$  is connected either  $E$  is empty or it coincides with  $D$ ). This property together with the continuity of the algebraic operations in the topology of  $\mathcal{S}$  from Definition 1 allows us to extend to sections in a given domain the operations defined in the fibers.<sup>(39)</sup>

We give some examples.

1. A most important example of a sheaf of rings is the sheaf  $\mathcal{O}(M)$  of germs of holomorphic functions on a complex manifold  $M$ . The space of this sheaf is the union of the germs

$$\mathcal{O}(M) = \bigcup_{p \in M} \mathcal{O}_p, \quad (1)$$

and the topology in it is defined as follows: we fix an arbitrary germ  $\mathbf{f}_p \in \mathcal{O}(M)$  and take some element  $(U, f)$  representing it. For each point  $q \in U$  we denote by  $\mathbf{f}_q$  the germ of the function  $f$  at  $q$ , and as a neighborhood of the point  $\mathbf{f}_p$  we take  $\tilde{U} = \bigcup_{q \in U} \mathbf{f}_q$ . As before (see, for example, subsection 33 of Part I) one verifies that the topology defined by these neighborhoods is Hausdorff; this space is of course disconnected.

The projection is defined as a mapping  $\pi: \mathcal{O}(M) \rightarrow M$ , which to each germ  $\mathbf{f} \in \mathcal{O}_p$  associates the point  $p$ . In view of our choice of a topology in  $\mathcal{O}(M)$  this mapping is a local homeomorphism at each point  $\mathbf{f} \in \mathcal{O}(M)$ . Finally, as is not hard to see, the operations of addition and multiplication of germs are continuous in the topology of  $\mathcal{O}(M)$ . The sections of the sheaf  $\mathcal{O}(M)$  in a domain  $D \subset M$  are the holomorphic functions in  $D$ . We shall denote the set of them by the symbol  $\Gamma(D, \mathcal{O})$ , or simply  $\mathcal{O}(D)$  if there is no danger of confusing the set of sections of the sheaf with the sheaf itself.

In particular, the sheaf of germs of holomorphic functions over the space

<sup>(39)</sup> Suppose we are given two sections  $f, g \in \mathcal{S}(D)$ . Fix a point  $p \in D$  and find an element  $f(p) + g(p) \in \mathcal{S}_p$ . The inverse of the projection  $\sigma$  in a neighborhood  $\tilde{U}$  of the point  $f(p) + g(p)$  is a section of  $\mathcal{S}$  in  $\sigma(\tilde{U})$ , and it is not difficult to see that it extends to a section  $h \in \mathcal{S}(D)$ . We set  $f + g = h$ ; it is possible to prove that this is well defined, i.e., does not depend on the choice of the point  $p$ .

$\mathbb{C}^n$  is denoted by  $\mathfrak{R}^n$ . The open connected components of  $\mathfrak{R}^n$  will obviously be Riemann domains over  $\mathbb{C}^n$ , which we discussed in subsection 22.

2. The sheaf  $\mathcal{F}^{(r,s)}(M)$  of *germs of smooth  $(r, s)$ -forms* on a complex manifold  $M$  is defined analogously. The germ of such a form at a point  $p \in M$  is an equivalence class modulo the relation:  $\omega \sim \omega'$  if the corresponding coefficients of these forms coincide in some neighborhood of the point  $p$ . The set  $\mathcal{F}_p^{(r,s)}$  of germs at a given point  $p$  forms an abelian group under the operation of coefficient-wise addition of forms. The space of the sheaf is defined as

$$\mathcal{F}^{(r,s)}(M) = \bigcup_{p \in M} \mathcal{F}_p^{(r,s)}, \quad (2)$$

and the topology and projection are introduced exactly as in the case of the sheaf  $\mathcal{O}$ . The sections of the sheaf  $\mathcal{F}^{(r,s)}(M)$  in a domain  $D \subset M$  are forms of bidegree  $r, s$  with coefficients that are smooth in  $D$ . In particular, for  $r = s = 0$  we will obtain the sheaf  $\mathcal{F}(M)$  of germs of smooth functions on  $M$ .

We remark that the topology of the space  $\mathcal{F}^{(r,s)}$ , in contrast to  $\mathcal{O}$ , is NOT Hausdorff. In fact, take for example a smooth function  $f$  on  $M$  with compact support, and consider its germ  $\mathbf{f}_p$  at a boundary point of the support. The germ  $\mathbf{f}_p$  is different from the germ  $\mathbf{0}_p$  of a function that is identically equal to zero, but their neighborhoods certainly intersect: in any neighborhood of  $\mathbf{f}_p$  there is a germ of a function that is identically equal to zero.

3. The *constant sheaves*  $\mathbb{Z}$ ,  $\mathbb{R}$ , and  $\mathbb{C}$ . Suppose that the same object corresponds to each point  $p \in M$ , say the ring of integers  $\mathbb{Z}$ . Then we will say that over  $M$  we are given a constant sheaf and will denote it by the same symbol as this object (in our case  $\mathbb{Z}$ ). The sections of this sheaf in a domain  $D \subset M$  are constants (in our case, integers).

The sheaf of germs of holomorphic functions, like other sheaves considered in analysis, arises in a natural way in the process of passing to the limit of so-called presheaves.

DEFINITION 3. We say that we are given a *presheaf* of algebraic structures over a topological space  $M$  if we are given a basis  $\{U\}$  of open sets of  $M$  (i.e., any open set of  $M$  is a union of sets of the basis), in each set  $U$  of the basis a structure  $\mathcal{S}_U$  (group, ring or field) is defined, and to each pair  $U, V$  of sets of the basis such that  $V \subset U$  we associate a homomorphism

$$\rho_{UV}: \mathcal{S}_U \rightarrow \mathcal{S}_V, \quad (3)$$

and, if  $W \subset V \subset U$ , then the following transitivity condition holds:

$$\rho_{UW} = \rho_{VW} \circ \rho_{UV}. \quad (4)$$

A basic example of a presheaf of rings is a set of functions that are holomorphic in open subsets of a complex manifold. The homomorphism  $\rho_{UV}$  is the natural inclusion homomorphism of the ring  $\mathcal{O}(U)$  into  $\mathcal{O}(V)$ , which associates to each function  $f \in \mathcal{O}(U)$  its restriction  $f|_V$  to the set  $V \subset U$ .

The process of passing to the limit from a presheaf to a sheaf in the general case is reminiscent of the passage from holomorphic functions to their germs and the construction of the sheaf  $\mathcal{O}(M)$ . Suppose we are given a presheaf  $\{\mathcal{S}_U\}$  of algebraic structures over a topological space  $M$ . Fix a point  $p \in M$  and consider a basis  $\mathcal{U}_p$  of neighborhoods of the point  $p$ . We say that the elements  $f_U \in \mathcal{S}_U$  and  $g_V \in \mathcal{S}_V$ , where  $U, V \in \mathcal{U}_p$ , are *equivalent* at  $p$  if there exists a neighborhood  $W \subset U \cap V$  of  $p$  such that

$$\rho_{UW}(f_U) = \rho_{VW}(g_V). \quad (5)$$

The set of equivalence classes modulo this relation is called the *direct limit* of  $\{\mathcal{S}_U\}$  and is denoted by the symbol

$$\mathcal{S}_p = \lim_{U \in \mathcal{U}_p} \mathcal{S}_U. \quad (6)$$

In the set  $\mathcal{S}_p$  there is a natural algebraic structure which is provided from  $\mathcal{S}_U$  (cf. the definition of the actions on germs of holomorphic functions in subsection 29 of Part I).

We shall now show that

$$\mathcal{S} = \bigcup_{p \in M} \mathcal{S}_p \quad (7)$$

can be considered as a sheaf over the space  $M$ . In order to introduce a topology in  $\mathcal{S}$ , we remark that for each neighborhood  $U \in \mathcal{U}_p$  we can construct a mapping  $\rho_{Up}: \mathcal{S}_U \rightarrow \mathcal{S}_p$  associating to an element  $f \in \mathcal{S}_U$  the equivalence class  $\mathbf{f}_p \in \mathcal{S}_p$  containing it (it is not hard to see that  $\rho_{Up}$  is a homomorphism of the algebraic structures under consideration). Now for each element  $\mathbf{f} \in \mathcal{S}_p$  and neighborhood  $U \in \mathcal{U}_p$  we define the set

$$\tilde{U}_{\mathbf{f}} = \bigcup_{q \in U} \rho_{Uq}(f) \subset \mathcal{S}.$$

The set  $\tilde{\mathcal{U}}$  of such sets for all  $\mathbf{f} \in \mathcal{S}$  and all  $U$  from the basis of open sets of the space  $M$  can be taken as a basis of open sets in the topology of  $\mathcal{S}$ . In order to see this, it suffices to prove that for any  $\tilde{U}, \tilde{V} \in \tilde{\mathcal{U}}$  with nonempty intersection and for any element  $\mathbf{h}_p \in \tilde{U} \cap \tilde{V}$  there is a  $\tilde{W}_{\mathbf{h}_p} \subset \tilde{U} \cap \tilde{V}$  in  $\tilde{\mathcal{U}}$ . By construction  $p \in U \cap V$  and  $\mathbf{h}_p = \rho_{Up}(f) = \rho_{Vp}(g)$ , where  $f \in \mathcal{S}_U$  and  $g \in \mathcal{S}_V$  respectively. By the definition of direct limit there exists an open set  $W \subset U \cap V$  containing the point  $p$  and such that  $\rho_{UW}(f) = \rho_{VW}(g)$ ; setting  $h = \rho_{UW}(f)$ , we will obtain an element of  $\mathcal{S}_W$ , and then  $\tilde{W}_{\mathbf{h}_p} = \bigcup_{q \in W} \rho_{Wq}(h)$  is the desired neighborhood.

Finally, the projection  $\sigma: \mathcal{S} \rightarrow M$  is defined as a mapping associating the point  $p$  to the element  $\mathbf{f} \in \mathcal{S}_p$ . It is obvious that in the topology we have constructed on  $\mathcal{S}$  the projection is locally a homeomorphism, and the algebraic operations are continuous.

### Problems

1. Construct a smooth atlas of two charts for the sphere  $S^n = \{x \in \mathbb{R}^{n+1} : |x| = 1\}$ . [HINT: use the stereographic projection  $x \rightarrow \frac{x}{1 \pm x_n}$  from the poles of the sphere.]

2. Let  $a^1, \dots, a^{2n}$  be (real) linearly independent vectors in  $\mathbb{C}^n$  and  $\Gamma$  the group of transformations of the form  $z \rightarrow z + \sum_{\nu=1}^{2n} N_\nu a^\nu$ , where the  $N_\nu$  are integers. Two points  $z, z' \in \mathbb{C}^n$  are said to be equivalent if there exists a translation  $\lambda \in \Gamma$  such that  $\lambda(z) = z'$ . Prove that we can give the set  $\mathbb{C}^n/\Gamma$  of equivalence classes modulo this relation a structure of an  $n$ -dimensional complex manifold. ( $\mathbb{C}^n/\Gamma$  is called an  $n$ -dimensional complex torus.)

3. Prove that: (a) the Grassmann manifold  $G$  of all real two-dimensional planes in  $\mathbb{C}^2 = \mathbb{R}^4$  that pass through the origin is homeomorphic to the product of two two-dimensional spheres  $S^2 \times S^2$ ; (b) the complex lines in  $\mathbb{C}^2$  that pass through the origin form a sphere  $S^2 = \mathbb{C}\mathbb{P}^1$  in  $G$ .

4. Given differential forms  $\omega' = \sum_{k=1}^n a_k dz_k$  and  $\omega'' = \sum_{k=1}^n b_k dz_k$  of bidegree  $(1, 0)$  such that the corresponding vectors  $a = (a_1, \dots, a_n)$  and  $b = (b_1, \dots, b_n)$  are orthogonal in the sense of the Euclidean scalar product, prove that  $\omega' \wedge \omega'' = 0$  only if  $\omega' = 0$  or  $\omega'' = 0$ .

5. Prove that the complex lines in  $\mathbb{P}^3$  corresponding under the Penrose transformation (12) of subsection 13 to points of a light ray on  $M$  lie in the complex tangent plane to  $N$  at a point corresponding to this ray.

6. Prove that in the representation of complex Minkowski space by the Klein quadric (see subsection 13), the complex light cone with vertex  $Z^0$  is mapped into a surface lying in the intersection of the quadric with the complex tangent to it at the point corresponding to  $Z^0$ , the  $\alpha$ - and  $\beta$ -planes are mapped into planes on the quadric and a complex light ray into a complex line. [HINT: since the group  $\Gamma_0$  from subsection 13 is transitive we may assume that  $Z^0 = 0$ .]

7. By analogy with subsection 16 use Penrose's method to construct solutions in the domains  $M_\pm^c$  of the wave equation

$$\frac{\partial^2 u}{\partial x_0^2} = \frac{\partial^2 u}{\partial x_1^2} + \frac{\partial^2 u}{\partial x_2^2} + \frac{\partial^2 u}{\partial x_3^2}$$

extended into these domains.

8. Let  $'U \subset \mathbb{C}^{n-1}$  be a polydisc with center at  $'0$  and let  $U_n = \{|z_n| < 1\}$ . Prove that if for any  $'z \in 'U$  the function  $f \in \mathcal{O}('U \times U_n)$  has a unique zero  $z_n = g('z)$  in  $U_n$ , then  $g \in \mathcal{O}('U)$ .

9. (a) Prove that any  $m$ -dimensional complex plane in  $\mathbb{C}^n$  passing through the origin can be mapped by a unitary transformation into the plane of the variables  $(z_1, \dots, z_m)$ . (b) A transformation of  $\mathbb{P}^n$  corresponding to a unitary transformation of  $\mathbb{C}^{n+1}$  under the standard transformation  $\rho: \mathbb{C}^{n+1} \setminus \{0\} \rightarrow \mathbb{P}^n$  is also termed unitary. Prove that it preserves the Fubini-Study metric and that under such a transformation any hypersurface in  $\mathbb{P}^n$  can be mapped to infinity.

10. Prove that the universal covering of the domain  $D = \overline{\mathbb{C}} \setminus \{z_1, \dots, z_p\}$ , where all the  $z_\nu$  are distinct and  $p \geq 3$ , is conformally equivalent to the unit disc.

11. Prove that the universal covering of a product of topological spaces  $M_1 \times M_2$  is homeomorphic to the product  $\widetilde{M}_1 \times \widetilde{M}_2$  of the universal coverings of these spaces.

12. Prove the following complex analogue of Theorem 1 of subsection 17: If  $\pi: \widetilde{M} \rightarrow M$  is a holomorphic covering, and  $f: D \rightarrow M$  is a holomorphic curve (a mapping of a domain  $D$  of the plane into  $M$ ), then  $f$  lifts to a holomorphic curve  $\tilde{f}: D \rightarrow \widetilde{M}$  and this can be done uniquely for a given  $\tilde{f}(\zeta_0) \in \widetilde{M}$ .

13. Let  $l_1, \dots, l_4$  be complex lines in  $\mathbb{C}\mathbb{P}^2$  in general position,  $l_5$  the complex line passing through the points  $l_1 \cap l_2$  and  $l_3 \cap l_4$ , and  $M = \mathbb{C}\mathbb{P}^2 \setminus \bigcup_{j=1}^5 l_j$ . Prove that: (a) the universal covering of  $M$  is biholomorphically equivalent to a bounded domain; (b) any holomorphic mapping  $f: \mathbb{C} \rightarrow M$  is constant.

14. Compute the fundamental group of the analytic set  $M = \{z \in \mathbb{C}^2 : e^{z^2} = (z_1 - a)(z_1 - b)\}$ . [HINT: consider the projection onto the first coordinate.]

15. Prove that to the cone  $\{z_1^2 + z_2^2 + z_3^2 = 0\} \subset \mathbb{C}^3$  under the standard mapping into  $\mathbb{P}^2$  there corresponds a complex curve homeomorphic to a torus.

16. Prove that the "semicubical parabola"  $\{z_1^2 = z_2^3\} \subset \mathbb{C}^2$  is a topological manifold in a neighborhood of the origin, but not a complex manifold there.

17. Prove that the irreducible analytic set  $M: z_3^3 = z_1^2 + z_2^2$  in  $\mathbb{C}^3$  is not a complex manifold; more precisely, there does not exist a holomorphic one-to-one mapping  $f: B \rightarrow M \cap U$ , where  $B$  is the unit ball in  $\mathbb{C}^2$  and  $U$  is a neighborhood of 0 in  $\mathbb{C}^3$ .

18. A one-dimensional analytic set in  $\mathbb{C}^n$ , irreducible at 0, up to a linear change of coordinates is locally given by the system of equations

$$z_\nu = \sum_{k=1}^{\infty} a_k^{(\nu)} z_1^{k/m}, \quad \nu = 2, \dots, n,$$

where  $m$  is some positive integer.

19. (W. RUDIN) Let  $f \in \mathcal{O}(\mathbb{C}^n)$  be an entire function, and for all points  $z = (z', z_n)$  of the analytic set  $A = \{f(z) = 0\}$  suppose that the inequality  $|z_n| < c(1 + |z'|^m)$  holds, where  $c$  and  $m$  are constants. Prove that then  $A$  is the set of zeros of some polynomial. [HINT: consider the integrals

$$\sigma_\mu(z') = \frac{1}{2\pi i} \int_{|\zeta|=r(z')} \zeta^\mu \frac{\frac{\partial f}{\partial z_n}(z', \zeta)}{f(z', \zeta)} d\zeta,$$

where  $r(z') = c(1 + |z'|^m)$  and  $\mu = 0, 1, 2, \dots$  and use the method of proof of the Weierstrass preparation theorem.]

20. (V. YA. LIN) Consider the bundle over the punctured plane  $\mathbb{C}_* = \mathbb{C} \setminus \{0\}$  whose space of fibers in  $E = \{(u, v) \in \mathbb{C}^2 : e^u - e^v \neq 0\}$ , and with the projection  $\pi(u, v) = e^u - e^v$ . Prove that this bundle has continuous but not holomorphic global sections [HINT: the identity  $e^{u(z)} - e^{v(z)} \equiv z$  in  $\mathbb{C}_*$  with  $u$  and  $v$  holomorphic is impossible by Picard's theorem.]

21. If there exist  $m$  global sections of a vector bundle  $\pi: X \rightarrow M$  with fiber dimension  $\dim E = m$  that are linearly independent over each point  $p \in M$ , then this bundle is trivial.

22. Let  $M$  be a real manifold of class  $C^k$  and dimension  $n$ ; prove that the tangent bundle  $T(M)$  is a manifold of class  $C^{k-1}$  and dimension  $2n$ .



## CHAPTER III

# Analytic Continuation

Any domain  $D$  of the plane is the natural domain of existence of a holomorphic function: there exists a function that is holomorphic in  $D$  and cannot be continued analytically beyond this domain (see subsection 46 of Part I). In contrast, in the space  $\mathbb{C}^n$  ( $n > 1$ ) there exist domains from which any holomorphic function can be directly continued into a larger domain. Examples of such domains are the nonlogarithmically convex Reinhardt domains (see subsection 7).

This chapter is mainly devoted to questions of analytic continuation, and, in particular, to the description of domains in  $\mathbb{C}^n$  which are domains of existence of holomorphic functions. One of the principal methods of analytic continuation is integral representations of holomorphic functions, and we begin with them.

### §10. Integral representations

**29. The formulas of Martinelli-Bochner and Leray.** In Chapter I we discussed the Cauchy integral formula

$$f(z) = \frac{1}{(2\pi i)^n} \int_{\Gamma} \frac{f(\zeta) d\zeta}{\zeta - z}, \quad (1)$$

which represents functions that are holomorphic in the polydisc  $U^n = \{z \in \mathbb{C}^n : |z_\nu| < r_\nu\}$  and continuous in its closure; here  $\Gamma = \{z \in \mathbb{C}^n : |z_\nu| = r_\nu\}$  is the skeleton of the polydisc and

$$\frac{d\zeta}{\zeta - z} = \frac{d\zeta_1 \wedge \cdots \wedge d\zeta_n}{(\zeta_1 - z_1) \cdots (\zeta_n - z_n)}.$$

This integral representation is very convenient, but it is applicable only to a narrow class of domains (it extends in an obvious way to products of planar domains) and it is very specific—the integration in formula (1) is not taken over the entire boundary of the polydisc, but only over its skeleton, i.e., its Shilov boundary. Here we obtain representations that are valid for arbitrary bounded domains with smooth or piecewise smooth boundaries, and the integration in these representations is taken over the whole boundary.



To obtain the first of them we consider a differential form of bidegree  $(n-1, n)$  in  $\mathbb{C}^n$  with a singularity at  $z = 0$ :

$$\omega(z) = \sum_{\nu=1}^n \frac{(-1)^{\nu-1} \bar{z}_\nu}{|z|^{2n}} d\bar{z}[\nu] \wedge dz, \quad (2)$$

where  $d\bar{z}[\nu] = d\bar{z}_1 \wedge \cdots \wedge d\bar{z}_{\nu-1} \wedge d\bar{z}_{\nu+1} \wedge \cdots \wedge d\bar{z}_n$ , and, as usual,  $dz = dz_1 \wedge \cdots \wedge dz_n$ . Since  $d(\bar{z}_\nu d\bar{z}[\nu]) = d\bar{z}_\nu \wedge d\bar{z}[\nu] = (-1)^{\nu-1} d\bar{z}$ , for  $z \neq 0$  we have

$$\begin{aligned} d\omega &= \sum_{\nu=1}^n \frac{\partial}{\partial \bar{z}_\nu} \left( \frac{\bar{z}_\nu}{|z|^{2n}} \right) d\bar{z} \wedge dz \\ &= \sum_{\nu=1}^n \left( \frac{1}{|z|^{2n}} - \frac{n \bar{z}_\nu z_\nu}{|z|^{2n+2}} \right) d\bar{z} \wedge dz = 0 \end{aligned} \quad (3)$$

(here we have used the fact that  $\sum z_\nu \bar{z}_\nu = |z|^2$ ), i.e., this form is closed in  $\mathbb{C}^n \setminus \{0\}$ .

Furthermore, for any sphere  $S_r = \{|z| = r\}$ ,

$$\int_{S_r} \omega = \frac{1}{r^{2n}} \int_{S_r} \sum_{\nu=1}^n (-1)^{\nu-1} \bar{z}_\nu d\bar{z}[\nu] \wedge dz,$$

and since the form in the integrand in the right-hand side does not have singularities, we can apply Stokes's formula:

$$\int_{S_r} \omega = \frac{n}{r^{2n}} \int_{B_r} d\bar{z} \wedge dz,$$

where  $B_r = \{|z| < r\}$  is the ball. But if  $z_\nu = x_\nu + idx_{n+\nu}$ , then  $d\bar{z}_\nu \wedge dz_\nu = 2idx_\nu \wedge dx_{n+\nu}$ , so that  $d\bar{z} \wedge dz = (2i)^n dx$ ,<sup>(1)</sup> where  $dx = dx_1 \wedge \cdots \wedge dx_{2n}$  is the volume element in  $\mathbb{R}^{2n}$ . Therefore the preceding formula can be rewritten in the form

$$\int_{S_r} \omega = \frac{n}{r^{2n}} (2i)^n \int_{B_r} dx = \frac{(2\pi i)^n}{(n-1)!} \quad (4)$$

(here we have used the fact that the integral on the right is equal to  $\text{Vol } B_r = \pi^n r^{2n}/n!$ ).

Suppose we are given a bounded domain  $D \subset \mathbb{C}^n$  with a piecewise smooth boundary  $\partial D$  and a function  $f \in \mathcal{O}(D) \cap C(\bar{D})$ ; we assume that  $0 \in D$ . By a well-known formula we have  $d(f\omega) = df \wedge \omega + f d\omega$  at points  $z \in D \setminus \{0\}$ . But  $df \wedge \omega = 0$ , since because of the holomorphy  $df$  is expressed only by means of the differentials  $dz_\nu$ , and  $\omega$  contains the product of all these

<sup>(1)</sup>To obtain this formula we must make identical permutations of the factors in the left- and right-hand sides. We also note that here we assume the positive orientation in  $\mathbb{R}^{2n}$  to be the one that corresponds to the order  $dx_1 \wedge \cdots \wedge dx_n \wedge dy_1 \wedge \cdots \wedge dy_n$ , and in subsection 19, to the order  $dx_1 \wedge dy_1 \wedge \cdots \wedge dx_n \wedge dy_n$  ( $y_\nu = x_{n+\nu}$ ); for odd  $n$  these orientations coincide, while for even  $n$  they are different.

differentials; the second term  $f d\omega = 0$  in view of (3). Thus, the form  $f\omega$  is closed in  $D \setminus \{0\}$ , and by Stokes's theorem the integral of  $f\omega$  over  $\partial D$  is equal to the integral over a sphere  $S_r$  of sufficiently small radius. Again using the continuity of the function and formula (4), we will obtain

$$\int_{\partial D} f\omega = \int_{S_r} f\omega = f(0) \frac{(2\pi i)^n}{(n-1)!} + \alpha(r),$$

where  $\alpha(r) \rightarrow 0$  as  $r \rightarrow 0$ . Since the left-hand side here does not depend on  $r$ , we have  $\alpha(r) \equiv 0$ , and hence,

$$f(0) = \frac{(n-1)!}{(2\pi i)^n} \int_{\partial D} f\omega. \quad (5)$$

It remains to take an arbitrary point  $z \in D$  instead of 0, to denote the point of integration by  $\zeta$  and to replace  $\omega(z)$  by a form that is different from  $\omega(\zeta - z)$  only by a scalar factor—the so-called *Martinelli-Bochner form*:

$$\omega_{\text{MB}}(\zeta - z) = \frac{(n-1)!}{(2\pi i)^n} \sum_{\nu=1}^n \frac{(-1)^{\nu-1} (\bar{\zeta}_\nu - \bar{z}_\nu)}{|\zeta - z|^{2n}} d\bar{\zeta}[\nu] \wedge d\zeta. \quad (6)$$

Formula (5) then leads to the following result:

**THEOREM 1.** *For any bounded domain  $D \subset \mathbb{C}^n$  with a piecewise smooth boundary  $\partial D$  and any function  $f \in \mathcal{O}(D) \cap C(\bar{D})$  at all points  $z \in D$  we have*

$$f(z) = \int_{\partial D} f(\zeta) \omega_{\text{MB}}(\zeta - z) \quad (7)$$

(the *Martinelli-Bochner integral formula*).<sup>(2)</sup>

We note that for  $n = 1$  the form

$$\omega_{\text{MB}}(\zeta - z) = \frac{1}{2\pi i} \frac{\bar{\zeta} - \bar{z}}{|\zeta - z|^2} d\zeta = \frac{1}{2\pi i} \frac{d\zeta}{\zeta - z},$$

so that the Martinelli-Bochner formula reduces to the Cauchy integral formula. The closeness with the latter is also witnessed by the fact that for functions  $f \in \mathcal{O}(D) \cap C(\bar{D})$  the integral in (7) is equal to 0 outside  $\bar{D}$ ; this follows from Stokes's theorem, since for  $z \in \mathbb{C}^n \setminus \bar{D}$  the form  $\omega_{\text{MB}}(\zeta - z)$  is closed and nonsingular in  $D$ . In particular, setting  $f(z) \equiv 1$ , we obtain that

$$\int_{\partial D} \omega_{\text{MB}}(\zeta - z) = \chi(z), \quad (8)$$

where  $\chi$  is the characteristic function of the domain  $D$ , equal to 1 for  $z \in D$  and equal to 0 outside  $\bar{D}$ . However, in contrast to the Cauchy kernel, the Martinelli-Bochner kernel does not depend holomorphically on the parameter  $z$  for  $n > 1$ .

<sup>(2)</sup>This formula was obtained by different methods by E. Martinelli in 1938 and by S. Bochner in 1943.

\* Prove that:

(1) For  $n > 1$

$$\omega_{\text{MB}}(\zeta - z) = \frac{(n-1)!}{(2\pi i)^n} \sum_{\nu=1}^n (-1)^{\nu-1} \frac{\partial g}{\partial \zeta_\nu} d\bar{\zeta}[\nu] \wedge d\zeta,$$

where  $g(z, \zeta) = -1/(n-1)|\zeta - z|^{2(n-1)}$  depends harmonically on  $z$  for  $z \neq \zeta$ .

(2) The Martinelli-Bochner integral with any function  $f$  continuous on  $\partial D$  is a harmonic function of  $z$  outside  $\partial D$ .

(3) For functions  $f \in C^1(\bar{D})$  the following generalization of the Cauchy-Green formula from subsection 19 of Part I is valid:

$$f(z) = \int_{\partial D} f(\zeta) \omega_{\text{MB}}(\zeta - z) - \frac{(n-1)!}{(2\pi i)^n} \int_{\partial D} (\bar{\zeta}_\nu - \bar{z}_\nu) \frac{\partial f}{\partial \bar{\zeta}_\nu} \frac{d\bar{\zeta} \wedge d\zeta}{|\zeta - z|^{2n}}. \quad *$$

Finally, we shall show that the Martinelli-Bochner differential form (6) possesses the properties of the  $\delta$ -function. In fact,  $d\omega(z) \neq 0$  for  $z \neq 0$ , and, formally applying Stokes's theorem to (8) and any domain  $D \ni 0$ , we obtain

$$\int_{\partial D} \omega = \int_D d\omega = 1,$$

and  $D$  here can be replaced by  $\mathbb{C}^n$ , since  $d\omega = 0$  for  $z \neq 0$ . The Martinelli-Bochner formula for  $z = 0$  can also be formally rewritten in the form

$$f(0) = \int_D d(f\omega) = \int_{\mathbb{C}^n} f d\omega$$

(here we have used the fact that  $d(f\omega) = f d\omega$  because  $f$  is holomorphic). Thus the Martinelli-Bochner formula expresses the well-known reproducing property of the  $\delta$ -function;<sup>(3)</sup> for  $n = 1$  the same is true for the Cauchy integral formula.

We will now derive a more general integral formula, found by J. LERAY in 1956 and which he called the CAUCHY-FANTAPPIÈ formula. For this we consider the forms

$$\begin{aligned} \delta(w) &= \sum_{\nu=1}^n (-1)^{\nu-1} w_\nu dw[\nu], \\ \Omega(z, w) &= \frac{(n-1)!}{(2\pi i)^n} \frac{\delta(w) \wedge dz}{\langle z, w \rangle^n}, \end{aligned} \quad (9)$$

where  $dw[\nu] = dw_1 \wedge \cdots \wedge dw_{\nu-1} \wedge dw_{\nu+1} \wedge \cdots \wedge dw_n$ ,  $dz = dz_1 \wedge \cdots \wedge dz_n$ , and

$$\langle z, w \rangle = \sum_{\nu=1}^n z_\nu w_\nu = (z, \bar{w}). \quad (10)$$

For  $w = \bar{z}$  the form  $\Omega$  obviously coincides with the Martinelli-Bochner form:  $\Omega(z, \bar{z}) = \omega_{\text{MB}}(z)$ . This form has singularities on the cone  $Q_0 = \{(z, w) \in \mathbb{C}^{2n} : \langle z, w \rangle = 0\}$ , and it is closed at the points of  $\mathbb{C}^{2n} \setminus Q_0$ , since at those points

$$d\Omega = \frac{(n-1)!}{(2\pi i)^n} \left\{ n \frac{dw \wedge dz}{\langle z, w \rangle^n} - \frac{n}{\langle z, w \rangle^{n+1}} \sum_{\nu=1}^n z_\nu w_\nu dw \wedge dz \right\} = 0.$$

<sup>(3)</sup>In the case of an arbitrary point  $z$  we replace  $\omega(z)$  by  $\omega(\zeta - z)$ .

One checks directly that  $\delta(w) = w_1^n d\left(\frac{w_2}{w_1}\right) \wedge \cdots \wedge d\left(\frac{w_n}{w_1}\right)$  and more generally that

$$\delta(w) = (-1)^{\nu-1} w_\nu^n d\left(\frac{w_1}{w_\nu}\right) \wedge \cdots \wedge d\left(\frac{w_{\nu-1}}{w_\nu}\right) \wedge d\left(\frac{w_{\nu+1}}{w_\nu}\right) \wedge \cdots \wedge d\left(\frac{w_n}{w_\nu}\right),$$

and since  $\langle z, w \rangle^n = w_\nu^n \langle z, w/w_\nu \rangle^n$ , then in fact the form  $\Omega$  does not depend on  $w$  but on the quotients of  $w$  by one of the coordinates of this vector, i.e.,  $\Omega$  is constant on complex lines in  $\mathbb{C}^n(w)$  that pass through the origin.

Suppose the function  $f$  and the domain  $D$  are the same as above. If  $0 \in D$ , then by the Martinelli-Bochner formula

$$f(0) = \int_{\partial D} f(z) \Omega(z, \bar{z}). \quad (11)$$

We may assume that here the form  $f(z) \Omega(z, w)$  is integrated over the  $(2n-1)$ -dimensional cycle  $\gamma_0 = \{(z, w) \in \mathbb{C}^{2n} : z \in \partial D, w = \bar{z}\}$ , which does not intersect the cone  $Q_0$ , since  $\langle z, \bar{z} \rangle = |z|^2 \neq 0$  for  $z \in \partial D$ . Our derivation<sup>(4)</sup> is based on the assertion that in this formula  $\gamma_0$  can be replaced by any other cycle  $\gamma_1 = \{(z, w) \in \mathbb{C}^{2n} : z \in \partial D, w = \lambda(z)\}$ , where  $\lambda: \partial D \rightarrow \mathbb{C}^n$  is a smooth vector-function such that  $\langle z, \lambda(z) \rangle \neq 0$  for  $z \in \partial D$  (i.e.,  $\gamma_1$  does not intersect  $Q_0$ ).

To prove this assertion we use the above-noted characteristic of the dependence of the form  $\Omega$  on  $w$ , according to which, without decreasing the value of the integral, the cycles  $\gamma_0$  and  $\gamma_1$  can be replaced respectively by the cycles  $\gamma'_0 = \{z \in \partial D, w = \bar{z}/|z|^2\}$  and  $\gamma'_1 = \{z \in \partial D, w = \lambda(z)/\langle z, \lambda(z) \rangle\}$  lying on the quadric  $Q_1 = \{(z, w) \in \mathbb{C}^{2n} : \langle z, w \rangle = 1\}$ . We span the cycles  $\gamma'_0$  and  $\gamma'_1$  by the  $(2n)$ -dimensional film

$$\sigma = \left\{ (z, w, t) \in \mathbb{C}^{2n} \times [0, 1] : w = t \frac{\lambda(z)}{\langle z, \lambda(z) \rangle} + (1-t) \frac{\bar{z}}{|z|^2} \right\},$$

for all points of which  $\langle z, w \rangle = 1$ , so that  $\sigma \in Q_1$ , and hence, does not contain singularities of the form  $\Omega$ ; the oriented boundary of this film is  $\gamma'_1 - \gamma'_0$ . By Stokes's formula

$$\int_{\gamma'_1} f \Omega - \int_{\gamma'_0} f \Omega = \int_{\sigma} d(f \Omega) = 0,$$

since because the form  $\Omega$  is closed outside  $Q_0$  and because  $df$  is expressed only by means of the differentials  $dz_\nu$ , and  $\Omega$  contains the product of them,  $d(f \Omega) = df \wedge \Omega + f d\Omega = 0$  on  $\sigma$ . Thus, in formula (11), rewritten in the form

$$f(0) = \int_{\gamma'_0} f(z) \Omega(z, w),$$

<sup>(4)</sup>This derivation was communicated to us by G. M. KHENKIN.

we can replace the cycle  $\gamma'_0$  by  $\gamma'_1$  or by  $\gamma_1$ , and we will find that

$$f(0) = \int_{\partial D} f(z)\Omega(z, \lambda(z)). \quad (12)$$

Changing the notation here as in the derivation of the Martinelli-Bochner formula, we obtain the following result.

**THEOREM 2.** *For any bounded domain  $D \subset \mathbb{C}^n$  with piecewise smooth boundary and any function  $f \in \mathcal{O}(D) \cap C(\bar{D})$  the Leray formula is valid:*

$$f(z) = \int_{\partial D} f(\zeta)\Omega(\zeta - z, \lambda(\zeta)) = \frac{(n-1)!}{(2\pi i)^n} \int_{\partial D} f(\zeta) \frac{\delta(\lambda(\zeta)) \wedge d\zeta}{\langle \zeta - z, \lambda(\zeta) \rangle^n}. \quad (13)$$

Here  $\lambda$  is an arbitrary smooth vector-function on  $\partial D$  such that  $\langle \zeta - z, \lambda(\zeta) \rangle \neq 0$  for all  $z \in D$  and  $\zeta \in \partial D$ .

The possibility of choosing this function differently—it can also depend on the point  $z$ —gives Leray's formula a particularly general character. In essence, this formula contains all the most usable integral representations of holomorphic functions.

Consider some examples.

1. For the ball  $B^n = \{z \in \mathbb{C}^n : |z| < 1\}$  we can take  $\lambda(\zeta) = \bar{\zeta}$ , since  $\langle \zeta - z, \bar{\zeta} \rangle = |\zeta|^2 - \langle z, \bar{\zeta} \rangle = 1 - \langle z, \zeta \rangle \neq 0$  for  $z \in B^n$  and  $\zeta \in \partial B^n$  (by Schwarz's inequality  $|\langle z, \zeta \rangle| \leq |z||\zeta| = |z| < 1$ ). Leray's formula takes the form

$$f(z) = \frac{(n-1)!}{(2\pi i)^n} \int_{\partial B^n} f(\zeta) \frac{\delta(\bar{\zeta}) \wedge d\zeta}{\{1 - \langle z, \zeta \rangle\}^n}. \quad (14)$$

2. Consider the domain  $D = \{z \in \mathbb{C}^n : \varphi(z) < 0\}$ , where  $\varphi \in C^1(\bar{D})$  and  $\nabla\varphi|_{\partial D} \neq 0$ , such that at each point  $\zeta \in \partial D$  the complex tangent plane  $T_\zeta^c(\partial D)$  lies outside of  $D$ —in particular, this condition is satisfied by all convex domains with a smooth boundary. Here we can take  $\lambda(\zeta) = \nabla_\zeta\varphi$ , since  $\langle \zeta - z, \nabla_\zeta\varphi \rangle = -\langle z - \zeta, \overline{\nabla_\zeta\varphi} \rangle$  vanishes only on  $T_\zeta^c(\partial D)$  (see subsection 17), and hence, is different from zero for all  $z \in D$  and  $\zeta \in \partial D$ .

If we write  $\frac{\partial\varphi}{\partial z_j} = \varphi_j$ , then  $\lambda = (\varphi_1, \dots, \varphi_n)$ , and by formula (9)

$$\delta(\lambda) = \sum_{j=1}^n (-1)^{j-1} \varphi_j d\varphi[j],$$

and since  $d\zeta$  contains the product of all the differentials  $d\zeta_\nu$ , we can replace all the  $d\varphi_\nu$  in the product  $\delta(\lambda) \wedge d\zeta$  by  $\bar{\partial}\varphi_\nu$ . But by the properties of exterior multiplication

$$\bar{\partial}\varphi[j] = \sum_{\nu=1}^n \frac{\partial(\varphi_1, \dots, \varphi_{j-1}, \varphi_{j+1}, \dots, \varphi_n)}{\partial(\bar{\zeta}_1, \dots, \bar{\zeta}_{\nu-1}, \bar{\zeta}_{\nu+1}, \dots, \bar{\zeta}_n)} d\bar{\zeta}[\nu]$$

and hence, the coefficient of  $d\bar{\zeta}[\nu] \wedge d\zeta$  in the product  $\delta(\lambda) \wedge d\zeta$  is equal to

$$\varphi_\nu = \sum_{j=1}^n (-1)^{j-1} \varphi_j \frac{\partial(\varphi_1, \dots, \varphi_{j-1}, \varphi_{j+1}, \dots, \varphi_n)}{\partial(\bar{\zeta}_1, \dots, \bar{\zeta}_{\nu-1}, \bar{\zeta}_{\nu+1}, \dots, \bar{\zeta}_n)}.$$

This expression can obviously be rewritten as a determinant

$$\varphi_\nu = \begin{vmatrix} \varphi_1 & \cdots & \varphi_n \\ \frac{\partial \varphi_1}{\partial \bar{\zeta}_1} & \cdots & \frac{\partial \varphi_n}{\partial \bar{\zeta}_1} \\ \vdots & & \vdots \\ \frac{\partial \varphi_1}{\partial \bar{\zeta}_n} & \cdots & \frac{\partial \varphi_n}{\partial \bar{\zeta}_n} \end{vmatrix}, \quad (15)$$

where the row with the derivatives with respect to  $\bar{\zeta}_\nu$  is omitted.

Thus, for domains of the type under consideration (and, in particular, for convex domains), Leray's formula can be written in the form

$$f(z) = \frac{(n-1)!}{(2\pi i)^n} \int_{\partial D} \frac{f(\zeta)}{\langle \nabla_\zeta \varphi, \zeta - z \rangle^n} \sum_{\nu=1}^n \varphi_\nu d\bar{\zeta}[\nu] \wedge d\zeta. \quad (16)$$

A useful peculiarity of this formula is the holomorphic dependence of its kernel on the parameter  $z$ , which does not occur in the Martinelli-Bochner formula.<sup>(5)</sup>

\* Prove that for convex bounded domains  $D = \{z \in \mathbb{C}^n : \varphi(z) < 0\}$  the Leray-Green formula is valid, which differs from (16) in that the term

$$-\frac{(n-1)!}{(2\pi i)^n} \int_D \sum_{\nu=1}^n (-1)^{\nu-1} \varphi_\nu \frac{\partial f}{\partial \bar{\zeta}_\nu} \frac{d\bar{\zeta} \wedge d\zeta}{\langle \nabla_\zeta \varphi, \zeta - z \rangle^n}$$

occurs in the right-hand side. \*

**30. Weil's formula.** Here we give yet another formula with a kernel that depends holomorphically on a parameter, which is applicable for a special class of domains.

**DEFINITION 1.** Suppose we are given a domain  $D \subset \mathbb{C}^n$  and a finite number of functions  $W_i \in \mathcal{O}(D)$  and planar domains  $D_i \subset \subset W_i(D)$ ,  $i = 1, \dots, n$ . We shall call the set

$$\Pi = \{z \in D : W_i(z) \in D_i, \quad i = 1, \dots, N\} \quad (1)$$

a *polyhedral set* if it is compact in  $D$ .

Such a set is not necessarily connected; a connected set of the form (1) will be called a *polyhedral domain*. Often one considers the case when all the domains  $D_i$  are discs; the corresponding set

$$\Pi = \{z \in D : |W_i(z)| < r_i, \quad i = 1, \dots, N\} \quad (2)$$

will be called an *analytic polyhedron*. If all the functions  $W_i$  are polynomials, then (2) is called a *polynomial polyhedron*.

In the special case when  $N = n$  and all the  $W_i(z) = z_i$ , a polyhedral domain is polycircular, and a polyhedron is a polydisc.

<sup>(5)</sup>We note that the kernel in formula (13) will depend holomorphically on  $z$  whenever the vector-function  $\lambda$  does not depend on  $z$  or depends on it holomorphically.

**DEFINITION 2.** A polyhedral set (1) is called a *Weil set* if  $N \geq n$  and 1) all its faces

$$\sigma_i = \{z \in D : W_i(z) \in \partial D_i, \quad W_j(z) \in \bar{D}_j, \quad j \neq i\} \tag{3}$$

are  $(2n - 1)$ -dimensional manifolds; 2) the intersection of any  $k$  distinct faces ( $2 \leq k \leq n$ )—an *edge* of the Weil set—has dimension at most  $2n - k$ . The set of all  $n$ -dimensional edges

$$\sigma_{i_1 \dots i_n} = \sigma_{i_1} \cap \dots \cap \sigma_{i_n} \tag{4}$$

of a Weil set is called its *skeleton*. Connected Weil sets are called *Weil domains*.

In order to obtain an integral representation of functions that are holomorphic in Weil domains, we need a special expansion of the functions  $W_i$  that define these domains. The possibility of such an expansion is guaranteed by Hefer's theorem:

**HEFER'S THEOREM.** For any function  $W_i \in \mathcal{O}(D)$ , where  $D$  is a domain of holomorphy in  $\mathbb{C}^n$ , there exist  $n$  functions  $P_\nu^i(\zeta, z) \in \mathcal{O}(D \times D)$  ( $\nu = 1, \dots, n$ ) such that for all points  $\zeta, z \in D$  the following identity holds:

$$W_i(\zeta) - W_i(z) = \sum_{\nu=1}^n (\zeta_\nu - z_\nu) P_\nu^i(\zeta, z). \tag{5}$$

In the general case Hefer's theorem is not elementary,<sup>(6)</sup> and we shall give a proof of it in subsection 50. Here we only remark that for polynomials the identity (5) is obtained by a simple regrouping of the Taylor expansion of the function  $W_i$  at the point  $z$ , and the Hefer coefficients  $P_\nu^i$  also turn out to be polynomials.

**THEOREM 1 (A. Weil).** Let  $\Pi$  be a Weil domain (1), defined by domains  $D_i$  with smooth boundaries. Then any function  $f \in \mathcal{O}(\Pi) \cap C(\bar{\Pi})$  at any point  $z \in \Pi$  can be represented by the formula

$$f(z) = \frac{1}{(2\pi i)^n} \sum'_{i_1 \dots i_n} \int_{\sigma_{i_1 \dots i_n}} \frac{f(\zeta)}{\prod_{\nu=1}^n \{W_{i_\nu}(\zeta) - W_{i_\nu}(z)\}} \begin{vmatrix} P_1^{i_1} & \dots & P_n^{i_1} \\ \vdots & & \vdots \\ P_1^{i_n} & \dots & P_n^{i_n} \end{vmatrix} d\zeta, \tag{6}$$

where the sum extends over all ordered sets of indices ( $1 \leq i_1 < \dots < i_n \leq N$ ) defining the edges of the skeleton of the domain,  $P_\nu^i$  are the Hefer coefficients for  $W_i$ , and  $d\zeta = d\zeta_1 \wedge \dots \wedge d\zeta_n$ ; the edges are oriented by the condition that all the  $\partial D_i$  are traversed in a positive direction.

In the case when  $\Pi$  is a polycircular domain ( $N = n$ ,  $W_i \equiv z_i$ ,  $i = 1, \dots, N$ ) the skeleton  $\Gamma$  consists of a single edge  $\sigma_{1 \dots n}$  (and coincides with the skeleton in the sense of subsection 2) and the sum in (6) consists of a single term. The Hefer coefficients  $P_\nu^i$  in this case are equal to 1 for  $i = \nu$

<sup>(6)</sup>Hefer's theorem was proved in 1942 and Weil's formula (6) was obtained in 1935.

and to 0 for  $i \neq \nu$ , i.e., the determinant in Weil's formula is equal to 1, and the formula takes the form

$$f(z) = \frac{1}{(2\pi i)^n} \int_{\Gamma} \frac{f(\zeta) d\zeta}{\prod_{\nu=1}^n (\zeta_{\nu} - z_{\nu})}. \quad (7)$$

Thus, Weil's formula generalizes Cauchy's integral formula for polycircular domains to the case of Weil domains. Like Cauchy's formula, it has a kernel that is holomorphic in the variables  $\zeta$  and  $z$ . To shorten the formal calculations we give a proof of Weil's theorem in the case  $n = 2$  and  $f \in \mathcal{O}(\bar{\Pi})$ .<sup>(7)</sup>

◀ We will start from the Martinelli-Bochner formula, which in the case of Weil domains in  $\mathbb{C}^2$  has the form

$$f(z) = \frac{1}{(2\pi i)^2} \sum_{i=1}^N \int_{\sigma_i} f(\zeta) \frac{(\bar{\zeta}_1 - \bar{z}_1) d\bar{\zeta}_2 - (\bar{\zeta}_2 - \bar{z}_2) d\bar{\zeta}_1}{|\zeta - z|^4} \wedge d\zeta, \quad (8)$$

where  $\sigma_i$  is a face of the domain  $\Pi$ . The idea for obtaining Weil's formula is the following: we will attempt to apply Stokes's formula to (8) so that the nonholomorphic differentials  $d\bar{\zeta}_{\nu}$  disappear and instead of the faces  $\sigma_i$  the integration is taken over the edges  $\sigma_{ij}$  of the skeleton; here it turns out that the nonholomorphy of the kernel also disappears (the variables  $\bar{\zeta}_{\nu} - \bar{z}_{\nu}$  and  $|\zeta - z|$  disappear). The Hefer expansion (5) plays a very important role in this transformation.

We remark first of all that the form  $\omega(\zeta, z)$  in the integrand of (8) is exact; it is the differential of any one of the  $N$  forms

$$\Omega_i(\zeta, z) = \frac{1}{|\zeta - z|^2 \{W_i(\zeta) - W_i(z)\}} \left| \begin{array}{cc} P_1^i & P_2^i \\ \bar{\zeta}_1 - \bar{z}_1 & \bar{\zeta}_2 - \bar{z}_2 \end{array} \right| d\zeta. \quad (9)$$

We confirm this by a direct computation, setting  $z = 0$  and  $W_i = W_i(\zeta) - W_i(0)$  for simplicity of notation:

$$\begin{aligned} d\Omega_i &= \frac{1}{W_i} \left\{ -\frac{\zeta_1 d\bar{\zeta}_1 + \zeta_2 d\bar{\zeta}_2}{|\zeta|^4} (P_1^i \bar{\zeta}_2 - P_2^i \bar{\zeta}_1) + \frac{1}{|\zeta|^2} (P_1^i d\bar{\zeta}_2 - P_2^i d\bar{\zeta}_1) \right\} \wedge d\zeta \\ &= \frac{1}{W_i |\zeta|^4} \{ -(\zeta_1 d\bar{\zeta}_1 + \zeta_2 d\bar{\zeta}_2) (P_1^i \bar{\zeta}_2 - P_2^i \bar{\zeta}_1) \\ &\quad + (\zeta_1 \bar{\zeta}_1 + \zeta_2 \bar{\zeta}_2) (P_1^i d\bar{\zeta}_2 - P_2^i d\bar{\zeta}_1) \} \wedge d\zeta \\ &= \frac{1}{W_i |\zeta|^4} (\bar{\zeta}_1 d\bar{\zeta}_2 - \bar{\zeta}_2 d\bar{\zeta}_1) (\zeta_1 P_1^i + \zeta_2 P_2^i) \wedge d\zeta \\ &= \frac{1}{|\zeta|^4} (\bar{\zeta}_1 d\bar{\zeta}_2 - \bar{\zeta}_2 d\bar{\zeta}_1) \wedge d\zeta, \end{aligned}$$

as required.

<sup>(7)</sup>For a complete derivation see the book by V. S. Vladimirov, *Methods of the theory of functions of several complex variables*, Chapter IV, §24, subsections 4 and 5, "Nauka", Moscow, 1964, pp. 248–252; English transl., MIT Press, Cambridge, MA, 1966.



We note also that for  $z \in \Pi$  and  $\zeta \in \sigma_i$  only the difference  $W_i(\zeta) - W_i(z)$  is nonzero (since  $W_i(\zeta) \in \partial D_i$  and  $W_i(z) \in D_i$ ), and all the remaining differences vanish at some points. Therefore, for  $z \in \Pi$ ,  $\zeta \in \sigma_i$  only the form  $\Omega_i$  is nonsingular, and all the remaining forms  $\Omega_j$ ,  $j \neq i$ , are singular, and under integration over the face  $\sigma_i$  Stokes's formula can be applied only as:

$$\int_{\sigma_i} f(\zeta)\omega(\zeta, z) = \int_{\sigma_i} d\{f(\zeta)\Omega_i(\zeta, z)\} = \sum_{\substack{j=1 \\ j \neq i}}^N \int_{\sigma_{ij}} f(\zeta)\Omega_i(\zeta, z)$$

(we have used the fact that the holomorphic function  $f$  can be inserted under the differential sign of the form  $\Omega_i$ ).

If we add these integrals together, as formula (8) requires, then each edge  $\sigma_{ij}$  will occur twice, with the opposite orientation (from the faces  $\sigma_i$  and  $\sigma_j$ ). Therefore we will have

$$\sum_{i=1}^N \int_{\sigma_i} f(\zeta)\omega(\zeta, z) = \sum'_{i,j=1}^N \int_{\sigma_{ij}} f(\zeta)\{\Omega_i(\zeta, z) - \Omega_j(\zeta, z)\},$$

where the summation is taken over all ordered pairs of indices ( $1 \leq i < j \leq N$ ).

It remains to note that under subtraction the nonanalytic parts of the kernels (9) cancel out:

$$\Omega_i - \Omega_j = \frac{1}{|\zeta|^2} \frac{|\zeta_1|^2 + |\zeta_2|^2}{W_i W_j} (P_1^i P_2^j - P_1^j P_2^i) d\zeta = \frac{1}{W_i W_j} \begin{vmatrix} P_1^i & P_2^i \\ P_1^j & P_2^j \end{vmatrix} d\zeta$$

(we have again used the above-mentioned abbreviations in notation and the Hefer expansion). Thus, we arrive at the formula

$$f(z) = \frac{1}{(2\pi i)^2} \sum'_{i,j=1}^N \int_{\sigma_{ij}} \frac{f(\zeta)}{\{W_i(\zeta) - W_i(z)\}\{W_j(\zeta) - W_j(z)\}} \begin{vmatrix} P_1^i & P_2^i \\ P_1^j & P_2^j \end{vmatrix} d\zeta, \quad (10)$$

which is Weil's formula for  $n = 2$ . ►

**REMARK.** If the Weil set (1) is not connected, then it splits into an at most countable number of connected components (Weil domains). Theorem 1 obviously remains valid if  $\Pi$  is a disconnected Weil set. In this case, for  $z$  belonging to some component, in Weil's formula (6) the only nonzero term is the integral over the skeleton of this component, and the integrals over the skeleta of the other components vanish. This follows from the fact that the Martinelli-Bochner integral, from which the Weil integral is derived, is equal to zero outside the domain.

The holomorphy of the kernel of Weil's formula is used, for example, in approximation by holomorphic functions from a certain class. We give the basic facts relating to this.

**THEOREM 2.** Any function  $f$  that is holomorphic in an analytic polyhedron (2) and continuous in its closure, can be expanded in a series

$$f(z) = \sum_{|k|=0}^{\infty} \sum'_{(i)} A_k^i [W_i(z)]^k \quad (11)$$

in this polyhedron, where  $k = (k_1, \dots, k_n)$  and  $i = (i_1, \dots, i_n)$  are vector indices,  $[W_i(z)]^k = [W_{i_1}(z)]^{k_1} \dots [W_{i_n}(z)]^{k_n}$ , the inner sum is taken over ordered sets  $1 \leq i_1 < \dots < i_n \leq N$ , and the coefficients are expressed by the formulas

$$A_k^i = \frac{1}{(2\pi i)^n} \int_{\sigma_{i_1} \dots \sigma_{i_n}} \frac{f(\zeta)}{[W_{i_1}(\zeta)]^{k_1+1} \dots [W_{i_n}(\zeta)]^{k_n+1}} \begin{vmatrix} P_1^{i_1} & \dots & P_n^{i_1} \\ \vdots & & \vdots \\ P_1^{i_n} & \dots & P_n^{i_n} \end{vmatrix} d\zeta. \quad (12)$$

The series (11) converges uniformly on any compact subset of the polyhedron  $\Pi$ .

◀ The expansion (11) is obtained from Weil's formula in exactly the same way as the Taylor expansion is obtained from the Cauchy integral formula. For any point  $z \in \Pi$  and any point  $\zeta$  on the skeleton of  $\Pi$  we can write the expansion in a convergent geometric progression:

$$\begin{aligned} \frac{1}{\prod_{\nu=1}^n [W_{i_\nu}(\zeta) - W_{i_\nu}(z)]} &= \sum_{k_1, \dots, k_n=0}^{\infty} \frac{[W_{i_1}(z)]^{k_1} \dots [W_{i_n}(z)]^{k_n}}{[W_{i_1}(\zeta)]^{k_1+1} \dots [W_{i_n}(\zeta)]^{k_n+1}} \\ &= \sum_{|k|=0}^{\infty} \frac{[W_i(z)]^k}{[W_i(z)]^{k+1}}. \end{aligned}$$

For fixed  $z \in \Pi$  this expansion converges on  $\sigma_{i_1 \dots i_n}$  uniformly in  $\zeta$ , and, substituting this in Weil's formula (6), we will obtain the expansion (11) with the coefficients (12).

The uniform convergence of the series (11) on compact subsets of the polyhedron  $\Pi$  is proved in the usual way. ▶

**COROLLARY 1.** Any function  $f$  that is holomorphic in an analytic polyhedron  $\Pi$  can be approximated arbitrarily exactly on any set  $K \subset \subset \Pi$  by functions that are holomorphic in the domain  $D$  that occurs in the definition of the polyhedron.

Briefly this corollary can be formulated as: the family of functions  $\mathcal{O}(D)$  is dense in the family  $\mathcal{O}(\Pi)$ .

◀ The partial sums of the series (11) obviously belong to  $\mathcal{O}(D)$ ; they approximate functions  $f \in \mathcal{O}(\bar{\Pi})$ . In order to avoid conditions of the continuity of  $f$  in  $\bar{\Pi}$  we must replace  $\Pi$  by the polyhedron  $\Pi' = \{z \in \Pi : |W_i(z)| < r'_i\}$ , where all the  $r'_i < r_i$  and are sufficiently close to the  $r_i$  ( $i$  is a scalar index). ▶

In particular, when  $\Pi$  is a polynomial polyhedron (i.e., all the functions  $W_i$  are polynomials), the partial sums of the series (11) are polynomials. We get

**COROLLARY 2.** *Any function  $f$  that is holomorphic in a polynomial polyhedron  $\Pi$  can be arbitrarily exactly approximated by polynomials on any set  $K \subset \subset \Pi$ .*

The domains of  $\mathbb{C}^n$ , on compact subsets of which every holomorphic function can be approximated arbitrarily closely by polynomials, are called *Runge domains* (cf. Runge's theorem in subsection 23 of Part I). Corollary 2 can be formulated as: *any polynomial polyhedron is a Runge domain.*

### §11. Extension theorems

We consider several theorems on the holomorphic extension of functions, which reflect the specifics of the higher-dimensional case.

**31. Extension from the boundary.** The first of these theorems asserts that in  $\mathbb{C}^n$  for  $n > 1$  every function that is holomorphic in some sense on the boundary of a domain can be extended holomorphically into the whole domain. The precise meaning of holomorphy on the boundary is that the function satisfies the so-called tangential Cauchy-Riemann equations on the boundary. These equations have come to play an important role in analysis and applications, and we shall discuss them in some detail.

In  $\mathbb{C}^n$  we consider a real hypersurface  $S$ , which in a neighborhood  $U \supset S$  is given by the equation  $\varphi(z) = 0$ , where  $\varphi \in C^1(U)$  and the gradient  $\nabla\varphi \neq 0$  in  $U$ . Suppose that in  $U$  we are given a complex function  $f$  of class  $C^1$ . Its differential  $\bar{\partial}f = \sum_{\nu=1}^n \frac{\partial f}{\partial \bar{z}_\nu} d\bar{z}_\nu$  at a point  $\zeta \in S$  can be decomposed into two terms, one of which,  $\bar{\partial}_N f = \lambda \bar{\partial}\varphi$  ( $\lambda \in \mathbb{C}$ ), is directed in the direction of the complex normal vector to  $S$  at this point, and the other,  $\bar{\partial}_T f = \bar{\partial}f - \bar{\partial}_N f$ , is directed complex-orthogonally to this normal.<sup>(8)</sup> The components  $\bar{\partial}_N f$  and  $\bar{\partial}_T f$  are respectively called the *normal* and *tangential components of  $\bar{\partial}f$* , and the operator  $\bar{\partial}_T$  is called the *tangential Cauchy-Riemann operator*. This operator was introduced by J. J. Kohn in 1965.

**DEFINITION.** Let  $S$  be a real hypersurface in  $\mathbb{C}^n$  and  $U$  a neighborhood of  $S$  as described above. We say that a function  $f \in C^1(U)$  satisfies the *tangential Cauchy-Riemann conditions* on  $S$ , or, more briefly, is a *CR-function* on  $S$  if, at each point  $\zeta \in S$ ,

$$\bar{\partial}_T f \equiv 0. \quad (1)$$

<sup>(8)</sup>We recall (see subsection 17) that the complex normal  $n_\zeta(S)$  is defined as the complex line  $\{z - \zeta = \lambda \bar{\nabla}_\zeta \varphi, \lambda \in \mathbb{C}\}$ , and the complex orthogonal directions to it form the complex tangent plane  $T_\zeta^c = \{(z - \zeta, \bar{\nabla}_\zeta \varphi) = 0\}$ ; here we identify the covectors  $\sum a_\nu d\bar{z}_\nu$  with the vectors  $a = (a_\nu)$ .

We shall prove that this notion is well defined in the sense that the tangential operator  $\bar{\partial}_T$  of the function  $f$  is determined only by the values of  $f$  on  $S$  and does not depend on the method of  $C^1$ -extension into the neighborhood  $U$ . To prove this we need the following analogue of the Weierstrass division theorem:

**LEMMA.** *If in a domain  $U \subset \mathbb{R}^n$  the function  $\varphi \in C^k$ ,  $k \geq 1$ , and  $\nabla\varphi = (\frac{\partial\varphi}{\partial x_1}, \dots, \frac{\partial\varphi}{\partial x_n}) \neq 0$ , and the function  $\psi \in C^k(U)$  vanishes everywhere where  $\varphi = 0$ , then there is a function  $h \in C^{k-1}(U)$  such that  $\psi(x) = h(x)\varphi(x)$  for all  $x \in U$ .*

◀ Since the assertion is local,  $U$  can be assumed to be an arbitrarily small convex neighborhood of the point  $0 \in S$ . Since  $\nabla\varphi \neq 0$  in  $U$ , then without loss of generality we may assume that  $\frac{\partial\varphi}{\partial x_n} \neq 0$  there and the equation  $\varphi(x) = 0$  is solvable in the form  $x_n = \varphi_1(x')$ , where  $x' = (x_1, \dots, x_{n-1})$ . After making the homeomorphic change of variables  $x' \rightarrow x'$ ,  $x_n \rightarrow x_n - \varphi_1(x')$  of class  $C^k$  the situation reduces to the case  $\varphi(x) \equiv x_n$  and a function  $\psi \in C^k(U)$  such that  $\psi(x', 0) = 0$ . From the obvious relation

$$\psi(x) = x_n \int_0^1 \frac{\partial}{\partial x_n} \psi(x', tx_n) dt,$$

valid for all  $x \in U$ , we see that we can take this integral as the function  $h$ ; it is obviously of class  $C^{k-1}(U)$ .<sup>(9)</sup> ▶

Let  $F$  and  $G$  be two  $C^1$ -extensions into  $U$  of a function  $f$  given on  $S$ . Since  $F - G$  vanishes on  $S$ , then by the Lemma  $F - G = h\varphi$ , where  $h \in C^0(U)$ . At the points of  $S$  we then have<sup>(10)</sup>  $\bar{\partial}F - \bar{\partial}G = h\bar{\partial}\varphi$ , and since  $h\bar{\partial}\varphi$  is directed along a complex normal to  $S$ , then  $\bar{\partial}_T F - \bar{\partial}_T G = 0$ . Thus, on  $S$  we have  $\bar{\partial}_T F = \bar{\partial}_T G$ , and the independence of  $\bar{\partial}_T$  from the extension of the function  $f$  outside of  $S$  is proved.

In applications it is convenient to use different forms of the tangential Cauchy-Riemann conditions. We give some of them here.

**THEOREM 1.** *The tangential Cauchy-Riemann conditions (1) are equivalent to each of the following conditions: at any point  $\zeta \in S$*

- (a)  $\bar{\partial}f \wedge \bar{\partial}\varphi = 0$ ,
- (b)  $\frac{\partial f}{\partial \bar{u}} = 0$  for any complex tangent direction  $u \in T_\zeta^c(S)$ ,
- (c)  $df \wedge dz = 0$ , where  $dz = dz_1 \wedge \dots \wedge dz_n$ .

<sup>(9)</sup>It is obvious that in the set where  $\varphi(x) \neq 0$ , the function  $h(x) = \psi(x)/\varphi(x) \in C^k$ ; the fact that on the set  $\{\varphi(x) = 0\}$  the smoothness of  $h$  can be decreased by one is shown by the example of the functions  $\varphi(x) = x_n$ ,  $\psi(x) = x_n + x_n^2 \sin(1/x_n)$ .

<sup>(10)</sup>This does not follow from the formula for differentiating a product (it cannot be applied since here we only have  $h \in C^0$ ), but it follows immediately from the definition of the partial derivatives of  $h\varphi$  on  $S$ .

◀ It follows from (1) that  $\bar{\partial}f = \lambda\bar{\partial}\varphi$ , and then (a) holds, since  $\lambda\bar{\partial}\varphi \wedge \bar{\partial}\varphi = 0$ . Conversely, if (a) holds, then

$$\frac{\partial f}{\partial \bar{z}_\mu} \frac{\partial \varphi}{\partial \bar{z}_\nu} - \frac{\partial f}{\partial \bar{z}_\nu} \frac{\partial \varphi}{\partial \bar{z}_\mu} = 0$$

for all  $\mu, \nu = 1, \dots, n$ , and hence  $\bar{\partial}f = \lambda\bar{\partial}\varphi$  for some  $\lambda \in \mathbb{C}$ , i.e., (1) holds.

To prove the other equivalences we take  $\zeta = 0$ . If we choose coordinates such that  $T_0^c(S) = \{z_n = 0\}$ , then the normal component  $\bar{\partial}_N f = \frac{\partial f}{\partial \bar{z}_n} d\bar{z}_n$ , and the tangential component

$$\bar{\partial}_T f = \sum_{\nu=1}^{n-1} \frac{\partial f}{\partial \bar{z}_\nu} d\bar{z}_\nu. \quad (2)$$

Since the vectors  $\frac{\partial}{\partial \bar{z}_1}, \dots, \frac{\partial}{\partial \bar{z}_{n-1}}$  form a basis of  $T_0^c(S)$ , then, using (2), equation (1) is equivalent to the system

$$\frac{\partial f}{\partial \bar{z}_\nu} = 0, \quad \nu = 1, \dots, n-1, \quad (3)$$

and this system is equivalent to condition (b).

Finally, if we choose coordinates such that the real tangent plane  $T_0(S) = \{\text{Im } z_n = 0\}$ , then  $dz_n = d\bar{z}_n$  there. As before,  $T_0^c(S) = \{z_n = 0\}$ , so that  $\bar{\partial}_T f$  is expressed by formula (2). Since  $dz$  is the product of all the  $dz_\nu$ , then in condition (c) the form  $df$  can be replaced by  $\bar{\partial}f$ , and because  $dz_n = d\bar{z}_n$  the last term in the expression for  $\bar{\partial}f$ , i.e.,  $\bar{\partial}_n f$  can be discarded:

$$\sum_{\nu=1}^{n-1} \frac{\partial f}{\partial \bar{z}_\nu} d\bar{z}_\nu \wedge dz_1 \wedge \dots \wedge dz_n = 0.$$

Since the differentials  $d\bar{z}_1, \dots, d\bar{z}_{n-1}, dz_1, \dots, dz_n$  are independent on  $T_0(S)$ , this equality is equivalent to the system (3), i.e., condition (b). ▶

Form (b) is particularly suitable for application. If the hypersurface  $S$  is given by the equation  $\varphi(z) = 0$ , then at the points of it at which  $\frac{\partial \varphi}{\partial z_n} \neq 0$ , a basis of the complex tangent plane is formed by the vectors

$$u_\nu = \frac{\partial \varphi}{\partial z_n} \frac{\partial}{\partial z_\nu} - \frac{\partial \varphi}{\partial z_\nu} \frac{\partial}{\partial z_n}, \quad \nu = 1, \dots, n-1 \quad (4)$$

(see subsection 27), and therefore in this case the tangential Cauchy-Riemann conditions on  $S$  are rewritten in the form

$$\bar{u}_\nu(f) = \frac{\partial \varphi}{\partial \bar{z}_n} \frac{\partial f}{\partial \bar{z}_\nu} - \frac{\partial \varphi}{\partial \bar{z}_\nu} \frac{\partial f}{\partial \bar{z}_n} = 0, \quad \nu = 1, \dots, n-1. \quad (5)$$

## EXAMPLES.

1. For the sphere  $\{z \in \mathbb{C}^n : |z| = 1\}$  the function  $\varphi(z) = \sum z_\nu \bar{z}_\nu - 1$ , so that at points where  $z_n \neq 0$ , the tangential Cauchy-Riemann equations have the form

$$z_n \frac{\partial f}{\partial \bar{z}_\nu} = z_\nu \frac{\partial f}{\partial \bar{z}_n}, \quad \nu = 1, \dots, n-1.$$

2. For the Poincaré sphere  $\{z \in \mathbb{C}^n : y_n = |z|^2\}$  (see Problem 18 to Chapter I) the function  $\varphi(z) = (z_n - \bar{z}_n)/2i - \sum_{\nu=1}^{n-1} z_\nu \bar{z}_\nu$ , so that at all points of this sphere the tangential Cauchy-Riemann conditions are written as:

$$\frac{\partial f}{\partial \bar{z}_\nu} = 2iz_\nu \frac{\partial f}{\partial \bar{z}_n}, \quad \nu = 1, \dots, n-1.$$

In particular we note the case  $n = 2$ ; if we set  $z_1 = z$  and  $z_2 = t + it$ , then the equation of the sphere has the form  $\tau = |z|^2$ . The value of  $\tau$  is determined by  $z$ , so that  $z$  and  $t$  will be independent coordinates on the sphere. Since

$$\frac{\partial}{\partial \bar{z}_2} = \frac{1}{2} \left( \frac{\partial}{\partial t} + i \frac{\partial}{\partial \tau} \right),$$

and for fixed  $z_1 = z$  and  $\tau = \text{const}$ , then  $\frac{\partial}{\partial \bar{z}_2} = \frac{1}{2} \frac{\partial}{\partial t}$  and the unique tangential Cauchy-Riemann equation has the form

$$\frac{\partial f}{\partial \bar{z}} = iz \frac{\partial f}{\partial t}.$$

This is the equation of H. Lewy (1956), which is well known in the theory of partial differential equations.

For  $n = 1$  there are no complex tangent directions and the concept of tangential Cauchy-Riemann equations makes no sense. Therefore the following theorem, to which this subsection is devoted, is specific for the higher-dimensional case. It was proved independently in 1943 by S. Bochner and F. Severi.

**THEOREM 2.** *Suppose that in  $\mathbb{C}^n$ ,  $n > 1$ , we are given a bounded domain  $D$  with smooth boundary  $S = \partial D$  and with connected complement. If a function  $f \in C^1(S)$  satisfies the tangential Cauchy-Riemann equation at all points of  $S$ , then  $f$  can be extended into the domain  $D$  to a function that is holomorphic in  $D$  and continuous in  $\bar{D}$ .*

◀ Under these hypotheses such an extension is realized by the Martinelli-Bochner integral:

$$\tilde{f}(z) = \int_S f(\zeta) \omega_{\text{MB}}(\zeta - z), \quad (6)$$

which is completely determined by the given values of  $f$  on  $S$ . In order to prove this we need some further properties of the form  $\omega_{\text{MB}}$ .

First of all we note that for fixed  $z$  and a  $\zeta$  such that  $\zeta_1 \neq z_1$ , the form  $\omega_{\text{MB}}(\zeta - z)$  is a differential (with respect to the variable  $\zeta$ ) of the form

$$\Omega_1(\zeta - z) = \frac{(n-2)!}{(2\pi i)^n} \sum_{\nu=2}^n \frac{(-1)^\nu}{|\zeta - z|^{2n-2}} \frac{\bar{\zeta}_\nu - \bar{z}_\nu}{\zeta_1 - z_1} d\bar{\zeta}[1, \nu] \wedge d\zeta, \quad (7)$$

where  $d\bar{\zeta}[1, \nu] = d\bar{\zeta}_2 \wedge \cdots \wedge d\bar{\zeta}_{\nu-1} \wedge d\bar{\zeta}_{\nu+1} \wedge \cdots \wedge d\bar{\zeta}_n$ . This is verified by a direct computation.<sup>(11)</sup>

Further, while the form  $\Omega_1$  has a singularity on the complex plane  $\zeta_1 = z_1$ , its partial derivative with respect to the parameter  $\bar{z}_1$  has only a point singularity  $\zeta = z$ :

$$\frac{\partial \Omega_1(\zeta - z)}{\partial \bar{z}_1} = \frac{(n-1)!}{(2\pi i)^n} \sum_{\nu=2}^n \frac{(-1)^\nu}{|\zeta - z|^{2n}} (\bar{\zeta}_\nu - \bar{z}_\nu) d\bar{\zeta}[1, \nu] \wedge d\zeta.$$

Finally, in view of the fact that the function  $f$  satisfies the tangential Cauchy-Riemann equation on  $S$ , which can be written in form (c) of Theorem 1 (i.e.,  $df \wedge d\zeta = 0$ ), and since the form  $\Omega$  contains the factor  $d\zeta$ , on  $S$  for  $\zeta_1 \neq z_1$  we have  $df \wedge \Omega_1 = 0$ . Thus, for  $\zeta \in S$  and  $\zeta_1 \neq z_1$

$$d(f(\zeta)\Omega_1(\zeta - z)) = f(\zeta)d\Omega_1(\zeta - z) = f(\zeta)\omega_{\text{MB}}(\zeta - z), \quad (8)$$

and for  $\zeta \in S$ ,  $\zeta \neq z$ ,

$$d\left(f(\zeta)\frac{d\Omega_1(\zeta - z)}{\partial \bar{z}_1}\right) = f(\zeta)\frac{\partial \omega_{\text{MB}}(\zeta - z)}{\partial \bar{z}_1} \quad (9)$$

(the differential is taken with respect to the variable  $\zeta$  and the partial derivative with respect to  $\bar{z}_1$  commutes with it).

We proceed directly to the proof.

(a) The function defined by the integral (6) is holomorphic everywhere outside of  $S$ . In fact, if  $z \notin S$ , then formula (9) can be applied and

$$\frac{\partial \tilde{f}}{\partial \bar{z}_1} = \int_S f(\zeta) \frac{\partial \omega_{\text{MB}}(\zeta - z)}{\partial \bar{z}_1} = \int_S d\left(f(\zeta) \frac{\partial \Omega_1(\zeta - z)}{\partial \bar{z}_1}\right) = 0$$

by Stokes's formula, since  $\partial S = 0$  (the boundary of  $S$  is a cycle). Isolating the other variables  $z_2, \dots, z_n$  instead of  $z_1$ , we construct analogous forms  $\Omega_2, \dots, \Omega_n$  and using them we prove that  $\partial \tilde{f}/\partial \bar{z}_2, \dots, \partial \tilde{f}/\partial \bar{z}_n$  are equal to 0 outside of  $S$ .

(b) The function  $\tilde{f}$  is equal to 0 everywhere outside of  $\bar{D}$ . In fact, in the part of  $\mathbb{C}^n \setminus \bar{D}$  where  $|z_1| > \max_{\zeta \in S} |\zeta_1|$ , the form (7) is nonsingular; therefore we may use the relation (8). We find that for  $z$  belonging to this part,

$$\tilde{f}(z) = \int_S f \omega_{\text{MB}} = \int_S d(f\Omega_1) = 0$$

<sup>(11)</sup>We give this computation, setting  $z = 0$  for simplicity:

$$\begin{aligned} d\Omega_1(\zeta) &= \frac{(n-1)!}{(2\pi i)^n} \sum_{\nu=2}^n \frac{(-1)^{\nu-1}}{|\zeta|^{2n}} \bar{\zeta}_\nu d\bar{\zeta}[1] \\ &\quad + \frac{(n-2)!}{(2\pi i)^n} \sum_{\nu=2}^n \frac{(-1)^\nu}{\zeta_1} \left( -\frac{n-1}{|\zeta|^{2n}} |\zeta_\nu|^2 + \frac{1}{|\zeta|^{2n-2}} \right) d\bar{\zeta}_\nu \wedge d\bar{\zeta}[2, \nu] \wedge d\zeta \\ &= \frac{(n-1)!}{(2\pi i)^n} \sum_{\nu=1}^n \frac{(-1)^{\nu-1}}{|\zeta|^{2n}} \bar{\zeta}_\nu d\bar{\zeta}[\nu] \wedge d\zeta = \omega_{\text{MB}}(\zeta). \end{aligned}$$

(we have again used Stokes's formula and the fact that  $S$  is a cycle). But the above-mentioned part of the complement to  $\bar{D}$  contains interior points, and since the complement itself is connected by hypothesis, by the uniqueness theorem  $\tilde{f} \equiv 0$  in the whole complement.

(c) Finally, we shall prove that the boundary values of the function  $\tilde{f}$  coincide with the given values of  $f$ . Taking the property of the Martinelli-Bochner kernel into account (formula (8) of subsection 29), for any  $\zeta^0 \in S$  and any  $z \notin S$  we can write

$$\tilde{f}(z) - \chi(z)f(\zeta^0) = \int_S [f(\zeta) - f(\zeta^0)]\omega_{\text{MB}}(\zeta - z), \quad (10)$$

where  $\chi$  is the characteristic function of the domain  $D$ .

The assertion will be completely proved, if we prove that the right-hand side of (10) is continuous at  $\zeta^0$ : in fact, the limit of the right-hand side as  $z \rightarrow \zeta^0$  from outside of  $D$  is obviously equal to zero; by continuity the limit as  $z \rightarrow \zeta^0$  from inside of  $D$  will also be equal to zero, i.e.,  $f(z) \rightarrow f(\zeta^0)$  as  $z \rightarrow \zeta^0$ ,  $z \in D$ .

Thus, it remains to prove that the function

$$g(z) = \int_S [f(\zeta) - f(\zeta^0)]\omega_{\text{MB}}(\zeta - z)$$

is continuous at the point  $\zeta^0$ . For this we note first that the integral

$$g(\zeta^0) = \int_S [f(\zeta) - f(\zeta^0)]\omega_{\text{MB}}(\zeta - \zeta^0) \quad (11)$$

exists. In fact, the integral is taken over a  $(2n - 1)$ -dimensional surface and the products of the differentials  $d\bar{\zeta}[\nu] \wedge d\zeta$  occurring in the form  $\omega_{\text{MB}}$  have the dimension of the  $(2n - 1)$ -dimensional volume element. Also the coefficients of these derivatives

$$\frac{|f(\zeta) - f(\zeta^0)|}{|\zeta - \zeta^0|^{2n}} (\bar{\zeta}_\nu - \bar{\zeta}_\nu^0)$$

have order at most  $1/|\zeta - \zeta^0|^{2n-2}$ , since  $f \in C^1(S)$ , and hence,  $f(\zeta) - f(\zeta^0)$ , like  $\zeta_\nu - \zeta_\nu^0$ , has order at least  $|\zeta - \zeta^0|$ . Thus, the order of infinity of the integrand in (11) is lower than the dimension by at least one, and hence, the integral (11) converges.<sup>(12)</sup>

The rest of the proof is carried out by methods usual in analysis, and we only indicate how it goes. We divide the difference

$$g(z) - g(\zeta^0) = \int_S [f(\zeta) - f(\zeta^0)][\omega_{\text{MB}}(\zeta - z) - \omega_{\text{MB}}(\zeta - \zeta^0)]$$

into two parts, corresponding to the integration over a sufficiently small (relative) neighborhood  $\sigma$  of the point  $\zeta^0$  and the integration of the remaining

<sup>(12)</sup>This is more simply seen by passing to polar coordinates on  $S$  with a pole at the point  $\zeta^0$ .



part  $S \setminus \sigma$  of the boundary. Because of the already proved convergence of the integral (11) the first part can be assumed to be small; in the integral over  $S \setminus \sigma$  the kernel is continuous, and hence, this integral is sufficiently small if  $z$  is sufficiently close to  $\zeta^0$ . ►

REMARK. This proof does not work for  $n = 1$ , since the Cauchy form  $d\zeta/(\zeta - z)$ , in contrast to the Martinelli-Bochner form, is not exact on  $\partial D$  if  $z \in D$  ( $\Omega_1$  cannot be constructed from formula (7) for  $n = 1$ ). The integral

$$\tilde{f}(z) = \frac{1}{2\pi i} \int_{\partial D} \frac{f(\zeta)}{\zeta - z} d\zeta$$

is of course holomorphic for  $z \notin \partial D$ , but  $\tilde{f}$  is not necessarily equal to zero outside of  $\bar{D}$ .<sup>(13)</sup>

As an example of the application of the Bochner-Severi theorem we give a proof of one of the main theorems of higher-dimensional complex analysis: the removal of compact singularities theorem.

**THEOREM 3.** *If the function  $f$  is holomorphic everywhere in the domain  $D \subset \mathbb{C}^n$  ( $n > 1$ ) except perhaps for a set  $K \subset\subset D$  such that  $K$  does not separate the domain (i.e., such that  $D \setminus K$  is connected), then  $f$  extends holomorphically to the whole domain  $D$ .*

◀ In  $D \setminus K$  we choose smooth  $(2n - 1)$ -dimensional surfaces  $S_1$  and  $S_2$  such that they respectively bound domains  $G_1$  and  $G_2$  with connected complements, such that  $K \subset\subset G_1 \subset\subset G_2$ , and such that the layer  $G = G_2 \setminus G_1 \subset\subset D$  (Figure 31).

Since  $f$  is holomorphic in  $\bar{G}$ , then by the Martinelli-Bochner formula for  $z \in G$  we have

$$f(z) = \int_{S_2} f(\zeta)\omega_{\text{MB}}(\zeta - z) - \int_{S_1} f(\zeta)\omega_{\text{MB}}(\zeta - z). \tag{12}$$

For the same reason the tangential Cauchy-Riemann conditions hold on  $S_1$  and  $S_2$

$$df \wedge d\zeta|_{S_1} = df \wedge d\zeta|_{S_2} = 0.$$

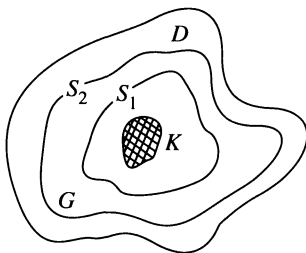

FIGURE 31

<sup>(13)</sup>See Problems 1 and 3 to Chapter II of Part I.

Since  $z$  lies outside the surface  $S_1$ , then by Theorem 2 the second integral in formula (12) is equal to zero, and hence, for all  $z \in G$ ,

$$f(z) = \int_{S_2} f(\zeta) \omega_{\text{MB}}(\zeta - z). \quad (13)$$

But again by the same theorem the integral in the right-hand side of (13) represents a function that is holomorphic everywhere in  $G_2$ , and which coincides with  $f$  in  $G_2 \setminus K$ . Since by hypothesis  $D \setminus K$  is connected, this function gives a holomorphic extension of  $f$  to the whole domain  $D$ . ►

**REMARK.** The condition that  $K$  does not separate the domain in Theorem 3 is essential: Let  $K = \{|z| = \frac{1}{2}\}$  be a sphere and  $D = \{|z| < 1\}$  a ball in  $\mathbb{C}^n$ ,  $n > 1$ ; then the function  $f$  that is equal to 0 in  $\{|z| < \frac{1}{2}\}$  and to 1 in  $\{\frac{1}{2} < |z| < 1\}$  is holomorphic in  $D \setminus K$  but does not extend holomorphically to  $D$ .

From this theorem we see that holomorphic functions of  $n \geq 2$  variables cannot have isolated singular points; the singularities of such functions (if they do not separate the domain) must go beyond the boundary of the domain or extend to infinity.<sup>(14)</sup>

The theorem on the removal of compact singularities (Theorem 3) is related to a number of the most important results in higher-dimensional complex analysis. The first statement of it and a not entirely convincing proof were given by F. HARTOGS (1906); in 1907 H. POINCARÉ proved it for the case of a ball in  $\mathbb{C}^2$  (a function that is holomorphic in a neighborhood of the bounding sphere extends holomorphically to the whole ball). Later proofs of this theorem occur in the textbook of OSGOOD (1924) and the paper of BROWN (1936). The proof given above is based on the later results of BOCHNER and SEVERI (1943).

\* Prove the following strengthening of Liouville's theorem: if a function of  $n \geq 2$  variables is holomorphic outside the ball  $\{|z| < R\}$  and bounded, then it is constant. \*

**32. Hartogs's theorem and the removal of singularities.** In the following theorem on compulsory analytic continuation the extension is realized by the Cauchy integral.

**THEOREM 1 (Hartogs).** *Suppose we are given domains  $G \subset \mathbb{C}^m(z)$ ,  $G_0 \subset G$  and a polydisc  $U \subset \mathbb{C}^n(w)$  with skeleton  $\Gamma$ ; we also write  $U^\bullet = U \cup \Gamma$  and  $M = (G \times \Gamma) \cup (G_0 \times U^\bullet)$ . If the function  $f: M \rightarrow \mathbb{C}$  is*

- (1) *continuous in  $G \times \Gamma$  and holomorphic in  $G$  for any  $\omega \in \Gamma$ ,*
- (2) *holomorphic in  $U$  and continuous in  $U^\bullet$  for any  $z \in G_0$ ,*

*then it extends holomorphically to the domain  $G \times U$  (see Figure 32 on the next page, where  $m = n = 1$ ).*

◀ We consider the function defined by the multiple Cauchy integral

$$F(z, w) = \frac{1}{(2\pi i)^n} \int_{\Gamma} \frac{f(z, \omega)}{\omega - w} d\omega. \quad (1)$$

Its integrand  $\frac{f(z, \omega)}{\omega - w}$  is continuous on  $\Gamma$  for arbitrary fixed values of the parameters  $(z, w) \in G \times U$  and for any  $\omega$  it depends holomorphically

<sup>(14)</sup>Compare: the function  $f = 1/z$  on the  $z$ -plane has the singular point  $\{0\}$ , and in  $(z, w)$ -space it has the singular complex line  $\{z = 0\}$ , which extends to infinity.

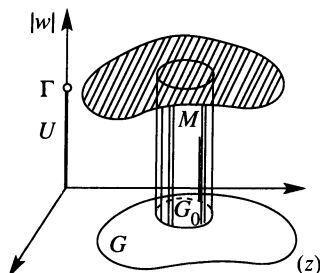

FIGURE 32

on these parameters; by the Lemma of subsection 5 the function  $F$  is also holomorphic in the product  $G \times U$ . But for fixed  $z \in G_0$ , by condition (2) the function  $f$  is represented in  $U$  by its Cauchy integral, and hence, in  $G_0 \times U$ ,

$$f(z, w) = \frac{1}{(2\pi i)^n} \int_{\Gamma} \frac{f(z, \omega)}{\omega - w} d\omega = F(z, w). \quad (2)$$

Thus, the function  $F$  holomorphically extends the function  $f$  into the domain  $G \times U$ . ►

Using Hartogs's theorem (or his method) we shall prove three theorems on the removal of singularities, in which the restrictions on the set to be removed are successively strengthened, but the conditions on the function are weakened. The first two of them are valid also when  $n = 1$ .

**THEOREM 2.** *If the function  $f$  is continuous in a domain  $D \subset \mathbb{C}^n$  and holomorphic in  $D \setminus S$ , where  $S$  is a smooth real hypersurface,<sup>(15)</sup> then it is holomorphic in  $D$ .*

◀ It suffices to prove that  $f$  is holomorphic at an arbitrary point  $a \in S$ , which without loss of generality can be assumed to be 0, and to assume that in a neighborhood of this point  $S$  is given by the equation  $y_1 = \varphi(x_1, w)$ , where  $w = (z_2, \dots, z_n)$ , and  $\varphi$  is a smooth real function (Figure 33). Since  $\varphi(0, 0) = 0$ , then since  $\varphi$  is continuous for any  $\beta > 0$  there are an  $\alpha > 0$  and a polydisc  $U \subset \mathbb{C}^{n-1}(w)$ ,  $0 \in U$ , such that  $|\varphi(x_1, w)| < \beta$  for all  $|x_1| < \alpha$  and  $w \in U$ . Choosing  $\beta$  sufficiently small and a  $\gamma > \beta$  sufficiently close to it, we find that the domain  $G_0 \times U$ , where  $G_0 = \{z_1 \in \mathbb{C} : |x_1| < \alpha, \beta < y_1 < \gamma\}$ , belongs to  $D$  and in it there are no points of  $S$ , i.e.,  $f \in \mathcal{O}(G_0 \times U)$ .

On the other hand, for fixed  $w \in U$  the function  $f(z_1, w)$  is holomorphic in the rectangle  $G = \{|x_1| < \alpha, |y_1| < \gamma\}$  everywhere except for the smooth curve  $y_1 = \varphi(x_1, w)$  and is continuous in  $G$ . From this it follows (see the proof of the Lemma in subsection 42 of Part I) that  $f(z_1, w)$  is holomorphic in  $G$  for fixed  $w \in U$ . By Hartogs's theorem we conclude

<sup>(15)</sup>For  $n = 1$  it is a smooth curve.

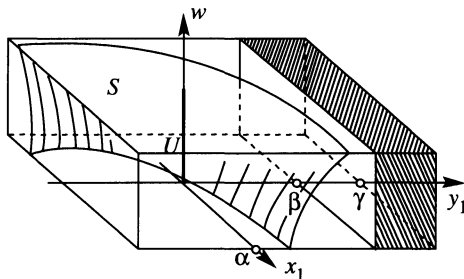

FIGURE 33

that  $f$  is holomorphic in the domain  $G \times U \subset \mathbb{C}^n$ , containing the point  $z = 0$ . ►

The following theorem is a generalization of the theorem of the removability of a singular point, in a neighborhood of which a holomorphic function is bounded—sometimes it is called *Riemann's extension theorem* (for  $n = 1$  an analytic set consists of isolated points).

**THEOREM 3.** *If  $f$  is a function holomorphic in  $D \setminus A$ , where  $D$  is a domain in  $\mathbb{C}^n$  and  $A$  is an analytic set of codimension 1, and if  $f$  is locally bounded<sup>(16)</sup> at the points of  $A$ , then it extends uniquely to a function holomorphic in  $D$ .*

◀ The uniqueness of the extension is obvious, since the set  $D \setminus A$  is connected (see subsection 24). It suffices to prove that  $f$  can be extended holomorphically at an arbitrary point  $a \in A$ , and we may assume that  $a = 0$ . We may also assume that the function  $g$  that defines the set  $A$  in a neighborhood of 0 satisfies the condition  $g'(0, z_n) \neq 0$ . Then there is a circle  $\{|z_n| = r\}$  of sufficiently small radius, on which  $g'(0, z_n) \neq 0$ , and hence  $g'(z, z_n) \neq 0$  both for  $'z$  belonging to a sufficiently small neighborhood  $'U \subset \mathbb{C}^{n-1}$  and for  $|z_n| = r$ .

We consider the Cauchy integral:

$$F(z) = \frac{1}{2\pi i} \int_{\{|\zeta_n|=r\}} \frac{f('z, \zeta_n)}{\zeta_n - z_n} d\zeta_n; \quad (3)$$

for  $'z \in 'U$  the function  $f('z, \zeta_n)$  in the integrand is holomorphic in  $'z$ , because the points  $('z, \zeta_n)$  are in  $D \setminus A$ , since  $g \neq 0$  at them. Therefore  $F$  is also holomorphic with respect to  $'z$  in  $'U$ , and with respect to  $z_n$  it is holomorphic in the disc  $U_n = \{|z_n| < r\}$ ; thus,  $F$  is holomorphic in the domain  $U = 'U \times U_n$ . But for fixed  $'z \in 'U$  the function  $g('z, z_n)$  has a finite number of zeros in the disc  $U_n$ , which correspond to the points of  $A$ . Since by hypothesis  $f$  is bounded in a neighborhood of these points,

<sup>(16)</sup>This means that for every point  $z \in A$  there is a neighborhood  $U_z$  such that  $f$  is bounded in  $(D \setminus A) \cap U_z$ .

the singularities with respect to  $z_n$  are removable. After removing them, the function  $f'(z, z_n)$  in the disc  $U_n$  is represented by a Cauchy integral with respect to values on the circle  $\{|z_n| = r\}$ , i.e., it coincides with the function  $F$  and the latter is holomorphic in the domain  $U \ni 0$ . ►

The final theorem is valid only for  $n > 1$  and relates to theorems on compulsory analytic continuation, since no additional conditions are imposed on the function in them.

**THEOREM 4.** *If  $f$  is holomorphic in  $D \setminus A$ , where  $D$  is a domain in  $\mathbb{C}^n$  ( $n > 1$ ) and  $A$  is an analytic set of codimension at least 2, then  $f$  extends in a unique way to a function holomorphic in  $D$ .*

◀ As before the uniqueness of the extension is obvious. We shall prove the possibility of extension by induction on the complex dimension of the set  $A$ , which we assume to be equal to  $m \leq n - 2$ . If  $A$  is zero-dimensional ( $m = 0$ ), then it consists of isolated points (by Theorem 6 of subsection 24) and the extendability of  $f$  to each of them follows from the theorem on the removal of compact singularities (Theorem 3 of subsection 31).

Suppose that the assertion has been proved for dimensions less than  $m \leq n - 2$ , and that  $A$  is a set of dimension  $m$ . We shall prove that  $f$  can be extended to any regular point  $a \in A^0$ , which we may assume to be 0. Since in a neighborhood of 0  $A$  is a complex manifold of codimension at least 2, then (perhaps after a complex-linear coordinate change) we can find two functions  $g_1$  and  $g_2$ , holomorphic in a neighborhood  ${}''U$  of the point  ${}''0 \in \mathbb{C}^{n-2}$ , such that  $z_{n-1} - g_1({}''z)$  and  $z_n - g_2({}''z)$ , where  ${}''z = (z_1, \dots, z_{n-2})$ , vanish on  $A$ .

Suppose  $g_1({}''0) = g_2({}''0) = 0$  and  $w = (z_{n-1}, z_n)$ ; then the torus  $\Gamma = \{({}''0, w) : |z_{n-1}| = |z_n| = r\}$ , where  $r > 0$  and is sufficiently small, lies in  $D \setminus A$ , and hence, the function

$$F({}''z, w) = \frac{1}{(2\pi i)^2} \int_{\Gamma} \frac{f({}''z, \zeta)}{\zeta - w} d\zeta \quad (4)$$

is holomorphic for all  ${}''z \in {}''U$  and all  $w$  in the bidisc  $U^2 = \{|z_{n-1}| < r, |z_n| < r\}$ . But for fixed  ${}''z$  the point  $({}''z, w) \in A$  only for  $z_{n-1} = g_1({}''z)$  and  $z_n = g_2({}''z)$ ; therefore as a function of  $w$   $F$  can only have a point singularity, which is removable. Consequently,  $F = f$ , i.e.,  $f$  extends holomorphically to the point 0.

This proves the extendability of  $f$  to the set  $A^0$  of regular points of  $A$ , and since the critical points form an analytic set of codimension less than  $m$ , then  $f$  extends to these points by the induction hypothesis. ►

\* Prove that a function  $f$  that is holomorphic in  $\mathbb{C}^2 \setminus \mathbb{R}^2$  extends to an entire function.\*

Somewhat more general extension theorems will be given in the following section. They are related to the concept of a domain of holomorphy, which we proceed to study.

### §12. Domains of holomorphy

These are domains in which there exist holomorphic functions that cannot be extended holomorphically to the outside of these domains. The theorems of §11 show that in  $\mathbb{C}^n$  for  $n > 1$  there are domains that are not domains of holomorphy, and here we shall discuss the characterization and properties of the latter.

**33. The concept of a domain of holomorphy.** The effect of compulsory analytic continuation leads to the following definition.

**DEFINITION 1.** A domain  $G$  that contains a domain  $D$  is called a *holomorphic extension* of  $D$  if any function  $f \in \mathcal{O}(D)$  extends to a function that is holomorphic in  $G$ .

It is clear that this definition is meaningful only in the case of dimension greater than 1. An interesting peculiarity of this case is expressed by the following simple theorem.

**THEOREM 1.** *If  $G$  is a holomorphic extension of a domain  $D$ , then the extension of any function  $f \in \mathcal{O}(D)$  can take only those values at points of  $G \setminus D$  that  $f$  takes in  $D$ .*

◀ Suppose on the contrary that a function  $f \in \mathcal{O}(D)$  takes some value  $w_0$  in  $G \setminus D$  that it does not take in  $D$ . Then the function  $g(z) = \frac{1}{f(z) - w_0}$  is obviously holomorphic in  $D$ , but cannot be extended analytically into  $G$ , since at some point of  $G \setminus D$  it goes to infinity. This contradicts Definition 1. ▶

**COROLLARY.** *A holomorphic extension  $G$  of a bounded domain  $D \subset \mathbb{C}^n$  is also a bounded domain.*

◀ By Theorem 1 the functions  $f_\nu(z) = z_\nu$  (the coordinates of the point  $z$ ) take the same values in  $G$  as in  $D$ , i.e.,

$$\sup_{z \in G} |z_\nu| = \sup_{z \in D} |z_\nu|, \quad \nu = 1, \dots, n. \quad (1)$$

But since  $D$  is bounded, the right-hand sides of (1) are finite, and hence the left-hand sides are also finite, i.e.,  $G$  is bounded. ▶

Domains of holomorphy cannot simply be considered to be domains that coincide with their holomorphic extensions in  $\mathbb{C}^n$ . The point is that the analytic continuation of a function from a domain in  $\mathbb{C}^n$  can lead to multi-sheeted Riemann domains, which we considered in subsection 22.

**EXAMPLE.** Let  $D \subset \mathbb{C}^2$  be a simply connected domain, whose Hartogs diagram is shown in Figure 34 on the next page. It is the cylinder  $\{x_1^2 + y_1^2 < 1, |z_2| < 2\}$  with the squares  $I = \{0 \leq x_1 < 1, y_1 = 0, |z_2| \leq 1\}$ ,  $II = \{0 \leq y_1 < 1, x_1 = 0, 1 \leq |z_2| < 2\}$  and the sector  $S = \{|z_1| < 1, x_1 \geq 0, y_1 \geq 0, |z_2| = 1\}$  removed. By Hartogs's theorem every function  $f \in \mathcal{O}(D)$  is extended analytically through the sector  $S$  both from above to below and from

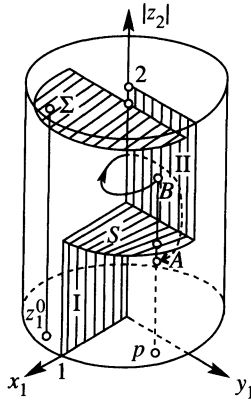

FIGURE 34

below to above.<sup>(17)</sup> In fact, we consider, for example, the first of these methods, from above to below: the function  $f$  is holomorphic in a neighborhood of the polydisc  $\Sigma = \{|z_1| \leq 1 - \varepsilon, x_1 \geq \varepsilon, |z_2| = 2 - \varepsilon\}$  and the segment  $\{z_1 = z_1^0, |z_2| \leq 2 - \varepsilon\}$ , where  $|z_1^0| < 1, x_1^0 > 0, y_1^0 < 0$ , and hence,  $f$  is extendable to  $\Sigma \times \{|z_2| < 2 - \varepsilon\}$ .

Under this extension we again land in the domain  $D$ , but the function does not take the same values as it previously had. In fact, consider, for example, the function  $f_0(z_1, z_2) = \sqrt{z_1}$ , considering the branch of the square root that is continuous in  $D$ ; this function takes positive values on the half-axis  $x_1 > 0$ . It is obviously holomorphic in  $D$  and at the points  $A$  and  $B$  of the diagram, which are projected to the same point  $P$  of the  $z_1$ -plane but are located on different sides of  $S$ , and it takes values that differ in sign (passing from  $A$  to  $B$  in  $D$ , we must vary  $\arg z_1$  by  $2\pi$ ). On the other hand, extending  $f_0$  through  $S$  by Hartogs's theorem (as described above), we find that the values of  $f_0$  at the point  $B$ , say, and its extension at  $A$  must be the same.

Thus, the extension of  $f_0$  leads us to a MULTIPLE-VALUED function; since we do not wish to consider such functions, we must assign the extended values to a second copy of the domain  $D$ , gluing it to the first copy along the set  $S$ .

The domain  $D$  in this example is not a domain of holomorphy, although it does not have holomorphic extensions among domains of  $\mathbb{C}^2$ . In order to avoid similar phenomena, in the definition of a domain of holomorphy we must exclude not only the possibility of analytic extension outside of the domain of the function itself, but also of its restrictions to parts of the domain, say, to balls contained in the domain.

**DEFINITION 2.** A domain  $D \subset \mathbb{C}^n$  is called the *domain of holomorphy* of a function  $f$  if  $f \in \mathcal{O}(D)$  and if, for any point  $z^0 \in D$ , the restriction of  $f$  to the ball  $B(z^0, r)$ , where  $r$  is the distance from  $z^0$  to  $\partial D$ , does not extend holomorphically into the ball  $B(z^0, r_1)$ , where  $r_1 > r$ . A domain is called a *domain of holomorphy* if it is the domain of holomorphy of some function.

Beginning the study of conditions that characterize domains of holomorphy, we start with simple sufficient conditions. We shall say that there ex-

<sup>(17)</sup>For simplicity we shall speak about the sets shown in the Hartogs figure, understanding that we mean the corresponding sets in  $\mathbb{C}^2$ .

ists a *barrier* at a boundary point  $\zeta$  of a domain  $D \subset \mathbb{C}^n$  if, for any set  $K \subset\subset D$  and any  $\varepsilon > 0$  there is a function  $g \in \mathcal{O}(D)$  such that  $\|g\|_K = \max_{z \in K} |g(z)| \leq 1$ , but  $|g(z)| > 1$  at some point  $z \in B(\zeta, \varepsilon)$ .

Obviously, if there exists a function  $f \in \mathcal{O}(D)$  that is UNBOUNDED at a point  $\zeta \in \partial D$  (i.e., such that  $f(z^\nu) \rightarrow \infty$  with respect to some sequence  $z^\nu \in D$ ,  $z^\nu \rightarrow \zeta$ ), then a barrier exists at this point. In fact, for any  $K \subset\subset D$  and  $\varepsilon > 0$  we can take  $g(z) = f(z)/\|f\|_K$ . The converse also holds, even in the following stronger form:

**THEOREM 2.** *For any set  $E \subset \partial D$  of points at which a barrier exists, there is a function  $f \in \mathcal{O}(D)$  that is unbounded at all points of  $E$ .*

◀ First of all we note that there exists an at most countable set of points of  $\partial D$ , everywhere dense in  $\overline{E}$ , and that a function that is unbounded on this set will also be unbounded on  $E$ . Therefore,  $E$  can be assumed to be an at most countable set. Under this assumption, we construct a sequence  $\zeta^\nu \in E$  such that every point of  $E$  appears in it infinitely often.<sup>(18)</sup> Now for the proof it suffices to find a function  $f \in \mathcal{O}(D)$  and a sequence of points  $z^\nu \in D$  such that  $|z^\nu - \zeta^\nu| \rightarrow 0$  and  $f(z^\nu) \rightarrow \infty$ .

By induction we construct: 1) an increasing sequence of compact subsets  $K_\nu \subset\subset D$ , exhausting  $D$ , i.e., such that  $\bigcup_{\nu=1}^{\infty} K_\nu = D$ , 2) points  $z^\nu \in D$  such that  $|z^\nu - \zeta^\nu| < 1/\nu$ , and 3) functions  $f_\nu \in \mathcal{O}(D)$  such that

$$\|f_\nu\|_{K_\nu} \leq 1, \quad \text{but } |f_\nu(z^\nu)| > 1. \quad (2)$$

For this we take as  $K_1$  an arbitrary compact subset of  $D$  and by the definition of a barrier at the point  $\zeta^1$  there are a function  $f_1 \in \mathcal{O}(D)$  and a point  $z^1 \in D$  such that  $|z^1 - \zeta^1| < 1$  and  $|f_1(z^1)| > 1 \geq \|f_1\|_{K_1}$ . Now we assume that the construction has been carried out for all  $\mu \leq \nu - 1$ ; we take

$$K_\nu = K_{\nu-1} \cup \left\{ z \in D : \rho(z, \partial D) \geq \frac{1}{\nu}, |z| \leq \nu \right\} \cup \{z^1, \dots, z^{\nu-1}\}$$

and by the definition of a barrier at the point  $\zeta^\nu$  there are a function  $f_\nu \in \mathcal{O}(D)$  and a point  $z^\nu \in D$  such that  $|z^\nu - \zeta^\nu| < 1/\nu$  and the conditions in (2) hold. This proves the possibility of our construction.

Finally, considering that  $|f_\nu(z^\nu)| > 1$ , we choose a sequence of natural numbers  $p_\nu$  (beginning with  $p_1 = 1$ ) such that the inequality

$$\frac{1}{\mu^2} |f_\mu(z^\mu)|^{p_\mu} \geq \sum_{\nu=1}^{\mu-1} \frac{1}{\nu^2} |f_\nu(z^\nu)|^{p_\nu} + \mu, \quad \mu \geq 2, \quad (3)$$

holds, and we consider the series

$$f(z) = \sum_{\nu=1}^{\infty} \frac{1}{\nu^2} \{f_\nu(z)\}^{p_\nu}. \quad (4)$$

<sup>(18)</sup>Suppose that the points of the set  $E$  are numbered in some way; to construct the sequence  $\zeta^\nu$  we take the points in the following order: 1; 1, 2; 1, 2, 3; ...



For any  $z \in K_\mu$  we have  $|f_\nu(z)| \leq 1$  for  $\nu \geq \mu$ , and hence the series (4) converges uniformly on  $K_\mu$ . Since the  $K_\mu$  compactly exhaust  $D$ , it follows from this that the series (4) converges everywhere in  $D$  and that its sum  $f \in \mathcal{O}(D)$  (see the Theorem of Weierstrass in subsection 5). Finally, for any  $\mu = 1, 2, \dots$  we have

$$|f(z^\mu)| \geq \frac{1}{\mu^2} |f_\mu(z^\mu)|^{\rho_\mu} - \sum_{\nu=1}^{\mu-1} \frac{1}{\nu^2} |f_\nu(z^\mu)|^{\rho_\nu} - \sum_{\nu=\mu+1}^{\infty} \frac{1}{\nu^2} \geq \mu - \sum_{\nu=\mu+1}^{\infty} \frac{1}{\nu^2},$$

from which we see that  $f(z^\mu) \rightarrow \infty$ . ►

From this theorem we immediately obtain a sufficient condition for domains of holomorphy:

**COROLLARY.** *If there exists a barrier on an everywhere dense set of points of the boundary of  $D$ , then  $D$  is a domain of holomorphy.*

For example, there exists a barrier at every point  $\zeta$  of the boundary of the ball  $B = \{|z| < R\} \subset \mathbb{C}^n$ , since the function

$$f(z) = \frac{1}{R^2 - (z, \zeta)} \in \mathcal{O}(B)$$

is unbounded at the point  $\zeta$ . Consequently, the ball is a domain of holomorphy. This example is generalized by

**THEOREM 3.** *Every convex domain  $D \subset \mathbb{C}^n$  is a domain of holomorphy.*

◀ Since  $D$  is convex, for any point  $\zeta \in \partial D$  we can construct a support hyperplane  $\operatorname{Re}(z - \zeta, a) = 0$ , passing through  $\zeta$  and such that  $D$  lies on one side of it, and in it we take the complex plane  $(z - \zeta, a) = 0$ , which also passes through  $\zeta$  and does not contain points of  $D$ . Then the function  $f(z) = 1/(z - \zeta, a)$  is holomorphic in  $D$  and is not bounded at  $\zeta$ , i.e., there exists a barrier at  $\zeta$ . By the corollary  $D$  is a domain of holomorphy. ►

However, the condition of convexity is not necessary for a domain of holomorphy. This can be seen, for example, from the following theorem.

**THEOREM 4.** *If  $D_z$  is a domain of holomorphy in the space  $\mathbb{C}^n(z)$  and  $D_w$  is an analogous domain in the space  $\mathbb{C}^m(w)$ , then the product  $D_z \times D_w$  is a domain of holomorphy in the space  $\mathbb{C}^{n+m}(z, w)$ .*

◀ We take a function  $f$  for which  $D_z$  is a domain of holomorphy, and the analogous function  $g$  for  $D_w$ . Then  $f(z)g(w) \in \mathcal{O}(D_z \times D_w)$  and  $D_z \times D_w$  is its domain of holomorphy. ►

Since in  $\mathbb{C}^1$  any domain is a domain of holomorphy, and polycircular domains are products of domains of the plane, we have

**COROLLARY.** *Any polycircular domain in  $\mathbb{C}^n$  is a domain of holomorphy.*

In particular, the product  $D$  of two domains  $D_1$  and  $D_2$  of the plane, at least one of which, say  $D_1$ , is not convex, is a domain of holomorphy, although  $D$  is not convex.

In the following subsection we shall introduce a generalized notion of convexity, which is less intuitive than the usual, but in return gives a necessary and sufficient condition for domains of holomorphy.

**34. Holomorphic convexity.** The usual (geometric) convexity of a domain in  $\mathbb{R}^n$  can be characterized by the fact that the convex hull of any compactly contained subset is also compactly contained in the domain (Figure 35).

Now, the convex hull of a set  $K$  is the intersection of all the half-spaces containing this set, or, in other words, it is the set of points at which any real linear function takes values not exceeding its maximum on  $K$ . It is clear that for sets in  $\mathbb{C}^n$  real-linear functions can be replaced by complex-linear ones and then the convex hull of a set  $K$  is defined as the set  $\{z \in \mathbb{C}^n : |l(z)| \leq \|l\|_K \text{ for all complex-linear functions } l\}$  (as usual,  $\|l\|_K$  denotes the maximum modulus of the function  $l$  on the set  $K$ ).

If  $D$  is not a domain of holomorphy, then in any holomorphic extension of it all the functions from  $\mathcal{O}(D)$  take only those values that they take on  $D$  (see subsection 33). Therefore, in the introduction of a concept of convexity intended to characterize domains of holomorphy it is natural to construct hulls with respect to levels of all functions that are holomorphic in the domain rather than linear ones. Moreover, since certain functions are not defined outside of  $D$ , then one should assign only the points of the domain itself to the hull of its subsets.

A concept of this type was introduced by H. CARTAN and P. THULLEN in 1932.

DEFINITION 1. The *holomorphically convex hull* of a set  $M \subset D$  is the set

$$\widehat{M} = \{z \in D : |f(z)| \leq \|f\|_M \text{ for all } f \in \mathcal{O}(D)\}. \tag{1}$$

DEFINITION 2. A domain  $D$  is said to be *holomorphically convex* if, for any set  $K$  compactly contained in  $D$ , its holomorphically convex hull  $\widehat{K}$  is also compactly contained in  $D$ :

$$K \subset\subset D \Rightarrow \widehat{K} \subset\subset D \tag{2}$$

(see Figure 35, where it is shown how nonconvexity of the domain leads to the violation of this condition).

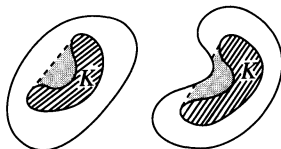

FIGURE 35

\* Let  $D = \{|z_1| < 1, |z_2| < 1\} \setminus \{|z_1| \leq \frac{1}{2}, |z_2| \leq \frac{1}{2}\}$  be a domain in  $\mathbb{C}^2$  and let  $K = \{z_1 = 0, |z_2| = \frac{3}{4}\}$  be a circle compactly contained in  $D$ ; prove that  $\widehat{K}$  is not compactly contained in  $D$ . \*

In some questions one must consider the hull relative only to the functions of some subclass  $F \subset \mathcal{O}(D)$  and not relative to all functions belonging to  $\mathcal{O}(D)$ ; in this case we speak about the  $F$ -convex hull (notation:  $\widehat{M}_F$ ) and about the  $F$ -convexity of domains. Thus, if  $F$  is the class of all  $\mathbb{C}$ -linear (or  $\mathbb{R}$ -linear) functions, then  $F$ -convexity coincides with geometric convexity; if  $F$  is the class of all polynomials or rational functions, then we speak about *polynomial convexity* or *rational convexity*.

It is obvious that the wider the class  $F$  is, the larger the set of functions for which inequality (2) is required to hold, and therefore, the narrower the  $F$ -convex hull of the set, and hence, the wider the class of  $F$ -convex domains. In particular, all convex domains are polynomially convex, and all polynomially convex domains are holomorphically convex.

EXAMPLES.

1. We illustrate the inclusion in the case of the plane. Any domain  $D \subset \mathbb{C}^1$  is holomorphically convex, but only domains with a connected complement in  $\overline{\mathbb{C}}^1$  will be polynomially convex (prove this!). The class of geometrically convex domains is narrower than the class of polynomially convex domains. Figuratively speaking, the passage to the polynomial hull of a domain of the plane reduces to filling in "holes" in it, and passage to the (geometrically) convex hull reduces to filling in "notches" close to the boundary.

2. Any analytic polyhedron

$$\Pi = \{z \in D : |W_\nu(z)| < 1, \nu = 1, \dots, N\}$$

(see subsection 30), where the functions  $W_\nu \in \mathcal{O}(D)$ , is convex relative to the class  $\mathcal{O}(D)$ . In fact if  $K \subset\subset \Pi$ , then for any  $\nu = 1, \dots, N$  we have  $\|W_\nu\|_K \leq r < 1$ . By the definition of  $\mathcal{O}$ -convex hull we have

$$\sup_{z \in \widehat{K}_\mathcal{O}} |W_\nu(z)| \leq \sup_{z \in K} |W_\nu(z)| \leq r,$$

and from this it follows that we also have  $\widehat{K}_\mathcal{O} \subset\subset \Pi$ .

As we shall now see, holomorphic convexity is a necessary and sufficient condition for domains of holomorphy.

**THEOREM 1 (Cartan-Thullen).** *If a domain  $D \subset \mathbb{C}^n$  is holomorphically convex, it is a domain of holomorphy.*

◀ This is proved analogously to the theorem on barriers from the previous subsection. As  $E$  we must take a countable everywhere dense set on  $\partial D$  and number it according to the method indicated there. The compact subsets  $K_\nu$  are also constructed by induction, only the points  $z^\nu$  and the functions  $f_\nu$  are chosen from other considerations: since  $D$  is holomorphically convex, the hull  $\widehat{K}_\nu \subset\subset D$ , and therefore there are a point  $z^\nu \in D$ ,  $|z^\nu - \zeta^\nu| < 1/\nu$ , and a function  $g_\nu \in \mathcal{O}(D)$  such that  $|g_\nu(z^\nu)| \geq \|g_\nu\|_{K_\nu}$ , and we set  $f_\nu(z) = g_\nu(z)/\|g_\nu\|_{K_\nu}$  ( $\nu = 1, 2, \dots$ ). The end of the proof is preserved and the function

$$f(z) = \sum_{\nu=1}^{\infty} \frac{1}{\nu^2} \{f_\nu(z)\}^{\nu^2} \tag{3}$$

is holomorphic in  $D$  and grows unboundedly as the points of  $E$  are approached, i.e.,  $D$  is a domain of holomorphy. ►

REMARK. It is obvious that in this theorem holomorphic convexity can be replaced by convexity relative to an arbitrary class  $F \subset \mathcal{O}(D)$ . In particular, if  $F$  is the class of linear functions, we again obtain Theorem 3 of the preceding subsection.

The proof of the necessity of the condition of holomorphic convexity is based on the so-called SIMULTANEOUS EXTENSION lemma, which is of independent interest.

LEMMA. Let  $K \subset\subset D$  and let  $\rho = \rho(K, \partial D)$  be the distance in the polydisc metric from  $K$  to the boundary  $\partial D$ . For any point  $a$  belonging to the holomorphically convex hull  $\widehat{K}$ , any function  $f \in \mathcal{O}(D)$  extends holomorphically to the polydisc  $U(a, \rho)$ .

It is essential that the polydisc  $U(a, \rho)$  can extend beyond the domain  $D$  (see the schematic representation in Figure 36); the radius of this polydisc does not depend on the individual function  $f \in \mathcal{O}(D)$  and is determined only by the distance from the set  $K$  to  $\partial D$ .

◀ Since  $a \in D$ , then any function  $f \in \mathcal{O}(D)$  in a neighborhood of  $a$  is represented by a Taylor series

$$f(z) = \sum_{|k|=0}^{\infty} c_k (z - a)^k, \tag{4}$$

where  $c_k = \frac{1}{k!} D^k f|_a$  and  $D^k f = \frac{\partial^{|k|} f}{\partial z^k}$ . But since  $a \in \widehat{K}$ , then

$$|D^k f|_a \leq \|D^k f\|_K, \tag{5}$$

i.e., the estimate of the derivatives at  $a$  reduces to their estimate on  $K$ .

We choose a number  $r < \rho$  and denote by  $K^r$  the  $r$ -dilatation of  $K$  (i.e., the union of all the polydiscs  $U(z, r)$ ,  $z \in K$ ). Since  $K^r \subset\subset D$ , then  $f$  is bounded on it, and we write

$$M_f(r) = \|f\|_{K^r}. \tag{6}$$

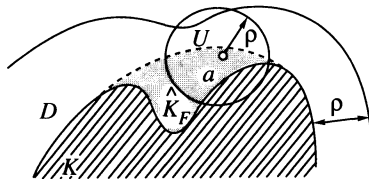

FIGURE 36

If  $z \in K$ , then  $U(z, r) \subset K^r$  and to estimate the derivatives in the right-hand side of (5) we can use the Cauchy inequalities (see subsection 5):

$$|c_k| \leq \frac{1}{k!} \|D^k f\|_K \leq \frac{M_f(r)}{r^{|k|}}.$$

Now we choose an arbitrary  $r_1 < r$ ; for an arbitrary point  $z \in U(a, r_1)$  we have

$$|c_k(z - a)^k| \leq M_f(r)(r_1/r)^{|k|}, \quad (7)$$

from which we see that the series (4) converges in the polydisc  $U(a, r_1)$ . Since the numbers  $r$  and  $r_1$  can be chosen as close to  $\rho$  as we wish, (4) converges everywhere in  $U(a, \rho)$ . This series gives the desired holomorphic extension of the function  $f$ . ►

From this Lemma we immediately obtain the necessity of the condition of holomorphic convexity.

**THEOREM 2 (Cartan-Thullen).** *Any domain of holomorphy  $D \subset \mathbb{C}^n$  is holomorphically convex.*

◄ We take an arbitrary set  $K \subset\subset D$  and write  $\rho = \rho(K, \partial D)$ . Since  $\mathcal{O}(D)$  contains all the coordinates  $z_\nu$ , then the holomorphically convex hull  $\widehat{K}$  is bounded. Further, since by the Lemma any function from  $\mathcal{O}(D)$  extends holomorphically to the  $\rho$ -dilatation of  $\widehat{K}$  and is a function  $f \in \mathcal{O}(D)$  that does not extend beyond  $D$ , this dilatation belongs to  $D$ , i.e.,  $\widehat{K} \subset\subset D$ .

►

**REMARK.** In the simultaneous extension lemma  $\mathcal{O}(D)$  can be replaced by any class  $F$  that contains both  $f$  and all its derivatives. For Theorem 2 to hold we also need that this class contains all the coordinates  $z_\nu$ ; without this additional assumption the Theorem may not be valid for unbounded domains. For example, if  $D_1 \subset \mathbb{C}$  is the domain of holomorphy of a function  $f$  of the variable  $z_1$ , then  $D = D_1 \times \mathbb{C}$  is also a domain of holomorphy, but it is not convex relative to the class  $F$  consisting of  $f$  and its derivatives with respect to  $z_1$  (for example, the  $F$ -convex hull of the set  $K_1 \times \{|z_2| < 1\}$ , where  $K_1 \subset\subset D_1$ , is  $K_1 \times \mathbb{C}$ ).

From the simultaneous extension lemma we also get a criterion for holomorphically convex domains which stresses their analogy with geometrically convex domains—these are domains in which passage from compact subsets to their holomorphically convex hulls occurs without decreasing the distance to the boundary. Figuratively speaking, this passage consists of filling in “holes” and “cavities” in these subsets.

**THEOREM 3.** *For a domain  $D \subset \mathbb{C}^n$  to be holomorphically convex it is necessary and sufficient that, for any set  $K \subset\subset D$ ,*

$$\rho(\widehat{K}, \partial D) = \rho(K, \partial D). \quad (8)$$

◄ The sufficiency of condition (8) is obvious. In order to prove the necessity we remark that the left-hand side of (8) never exceeds the right-hand side, and if there were an inequality, then in  $\widehat{K}$  there would be a point  $a$  for which  $\rho(a, \partial D) < \rho(K, \partial D)$ . But according to the Lemma, any function  $f \in \mathcal{O}(D)$  would then extend into the polydisc with center  $a$  and radius

$\rho(K, \partial D)$ , i.e., beyond the boundary of the domain  $D$ , and  $D$  cannot be a domain of holomorphy. ►

**35. Properties of domains of holomorphy.** The domains of holomorphy in  $\mathbb{C}^n$  are the holomorphically convex domains. We give some of their properties that generalize well-known properties of convex domains.

**THEOREM 1.** *Let  $D_\alpha$ ,  $\alpha \in A$ , be an arbitrary family of domains of holomorphy in  $\mathbb{C}^n$  and let  $G = \bigcap_{\alpha \in A} D_\alpha$  be their intersection. Every connected component  $D$  of the interior  $\hat{G}$  is a domain of holomorphy.*

◀ Suppose  $K \subset\subset D$ ; since every function from  $\mathcal{O}(D_\alpha)$  is also holomorphic in  $D$ , then  $\mathcal{O}(D) \supset \mathcal{O}(D_\alpha)$ , and hence,  $\hat{K}_{\mathcal{O}(D)} \subset \hat{K}_{\mathcal{O}(D_\alpha)}$  for all  $\alpha \in A$ . Therefore,  $\rho(\hat{K}_{\mathcal{O}(D)}, \partial D_\alpha) \geq \rho(\hat{K}_{\mathcal{O}(D_\alpha)}, \partial D_\alpha)$ , and hence, since  $D_\alpha$  is holomorphically convex, for all  $\alpha \in A$  we have  $\rho(\hat{K}_{\mathcal{O}(D)}, \partial D_\alpha) \geq \rho(K, \partial D_\alpha) \geq \rho(K, \partial D)$ . If  $D$  were not a domain of holomorphy, then for some  $K$  we would have  $\rho(\hat{K}_{\mathcal{O}(D)}, \partial D) < \rho(K, \partial D)$ , and then we could find a  $D_\alpha$  for which  $\rho(\hat{K}_{\mathcal{O}(D)}, \partial D_\alpha) < \rho(K, \partial D)$ , contrary to what was proved before. ►

In contrast to their intersection, the UNION of domains of holomorphy is not necessarily a domain of holomorphy (cf. the corresponding property for convex domains). This is seen from a simple example:  $\{|z_1| < 1, |z_2| < 2\}$  and  $\{|z_1| < 2, |z_2| < 1\}$  are domains of holomorphy in  $\mathbb{C}^2$  and their union is not (this was proved in subsection 7).

However, for the union of an INCREASING sequence of domains of holomorphy (as for convex domains) the assertion does hold. In order to prove it we need a theorem, also of independent interest, which is a generalization of Runge's approximation theorem from subsection 23 of Part I.

**THEOREM 2 (Oka-Weil).** *Let  $D$  be an arbitrary domain in  $\mathbb{C}^n$  and let  $K \subset\subset D$  be a compact subset that coincides with its convex hull relative to the class  $\mathcal{O}(D)$ :*

$$K = \hat{K}_{\mathcal{O}(D)}. \quad (1)$$

*Then any function  $f$  that is holomorphic on  $K$  (i.e., in some neighborhood of it) is approximated uniformly on  $K$  by functions from  $\mathcal{O}(D)$ .*

◀ Suppose  $f$  is holomorphic in a neighborhood  $U \subset D$  of the compact set  $K$  and let  $V \subset\subset U$  be another neighborhood of  $K$ . By the definition of the hull for any point  $\zeta \in \partial V$  there is a function  $W_\zeta(z) \in \mathcal{O}(D)$  such that  $|W_\zeta(\zeta)| > 1 > \|W_\zeta\|_K$ . Since  $\partial V$  is compact, then there exists a finite number of functions  $W_{\zeta_j} = W_j$  ( $j = 1, \dots, N$ ) such that  $\max_j |W_j(\zeta)| > 1$  for all  $\zeta \in \partial V$ , but  $\|W_j\|_K < 1$ .

Now consider the analytic polyhedron

$$\Pi = \{z \in V : |W_j(z)| < 1, j = 1, \dots, N\}, \quad (2)$$

containing  $K$  and compactly contained in  $V$ . The function  $f$  is holomorphic in a neighborhood of  $\bar{D}$ , and hence, by Weil's theorem (subsection 30)  $f$  is approximated uniformly on  $K$  by functions from  $\mathcal{O}(D)$ . ►

REMARK. For  $n = 1$  condition (1) means that the compact set  $K$  does not separate the domain  $D$  if  $D$  is simply connected. From this we see first that this condition is essential, and second, that Theorem 2 in fact generalizes Runge's theorem.

COROLLARY. Any connected component of the hull  $\widehat{K}_{\mathcal{O}(D)}$  of an arbitrary compact subset  $K \subset\subset D$  has nonempty intersection with  $\bar{K}$ .

◀ Let  $E$  be a connected component of  $\widehat{K}_{\mathcal{O}(D)}$  and  $E \cap K = \emptyset$ . Then there are disjoint open sets  $U \supset K$  and  $V \supset E$  such that  $\widehat{K}_{\mathcal{O}(D)} \subset U \cup V$ . We consider a holomorphic function  $f$  on  $U \cup V$  that is equal to 0 on  $U$  and equal to 1 on  $V$ . By Theorem 2 there is a  $g \in \mathcal{O}(D)$  such that  $\|f - g\|_{\widehat{K}_{\mathcal{O}(D)}} < \frac{1}{2}$ . In particular, for any point  $z^0 \in E$  we have

$$|g(z^0)| > \frac{1}{2} > \|g\|_K,$$

and this contradicts the fact that  $E \subset \widehat{K}_{\mathcal{O}(D)}$ . ►

We now proceed to prove the theorem we spoke about above.

THEOREM 3 (Behnke-Stein). The union  $D$  of an increasing sequence

$$D_1 \subset\subset D_2 \subset\subset \dots \subset\subset D_\nu \subset\subset \dots \quad (3)$$

of domains of holomorphy is also a domain of holomorphy.

◀ First we replace the  $D_\nu$  by bounded domains. For this we fix a point  $a \in D_1$  and denote by  $D'_\nu$  the connected component of the open set  $D_\nu \cap \{|z - a| < \nu\}$  containing  $a$ . By Theorem 1  $D'_\nu$  is a domain of holomorphy and obviously, as before,  $D'_\nu \subset\subset D'_{\nu+1}$  and  $D = \bigcup D'_\nu$ .

Further, we choose a subsequence  $D'_{p_\nu} = G_\nu$  from the sequence  $D'_\nu$  such that for all  $\nu = 1, 2, \dots$  the condition

$$\sup_{z \in \partial G_\nu} \rho(z, \partial G_{\nu+1}) < \rho(G_{\nu-1}, \partial G_{\nu+1}) \quad (4)$$

is satisfied. We shall prove the possibility of doing this by induction. We set  $G_1 = D'_1$  and we choose  $p_2$  so large that for  $G_2 = D'_{p_2}$  we will have  $\sup_{z \in \partial G_2} \rho(z, \partial D) < \rho(G_1, \partial D)$ ; after this we choose  $p_3$  so that the boundary of the domain  $G_3 = D'_{p_3}$  will be so close to  $\partial D$  that  $\partial D$  can be replaced by  $\partial G_3$  in the last inequality:  $\sup_{z \in \partial G_2} \rho(z, \partial G_3) < \rho(G_1, \partial G_3)$ . Suppose that the choice has been made for all natural numbers less than  $\nu$ ; we choose  $p_\nu$  such that for  $G_\nu = D'_{p_\nu}$  we will have

$$\sup_{z \in \partial G_\nu} \rho(z, \partial D) < \rho(G_{\nu-1}, \partial D), \quad (5)$$

and then we choose  $p_{\nu+1}$  such that  $D'_{p_{\nu+1}} = G_{\nu+1}$  will be so close to  $\partial D$  that  $\partial D$  can be replaced by  $\partial G_{\nu+1}$  in the last inequality, and thus we obtain (4).

Since  $G_{\nu-1} \subset\subset G_{\nu+1}$  and since  $G_{\nu+1}$  (as a domain of holomorphy) is convex relative to the class  $\mathcal{O}(G_{\nu+1})$ , then by Theorem 3 of subsection 34 for the hull  $G_{\nu-1}^* = (\widehat{G_{\nu-1}})_{\mathcal{O}(G_{\nu+1})}$  we have

$$\rho(G_{\nu-1}^*, \partial G_{\nu+1}) = \rho(G_{\nu-1}, \partial G_{\nu+1}). \tag{6}$$

But from (4) it follows that for any  $a \in \partial G_{\nu}$  we have

$$\rho(a, \partial G_{\nu+1}) < \rho(G_{\nu-1}, \partial G_{\nu+1}),$$

i.e.,  $\partial G_{\nu}$  does not intersect  $G_{\nu-1}^*$ . According to the Corollary of Theorem 2 it follows from this that

$$G_{\nu-1}^* \subset\subset G_{\nu}, \quad \nu = 1, 2, \dots \tag{7}$$

We need to prove that the domain  $D$  is holomorphically convex. For this we fix an arbitrary compact set  $K \subset\subset D$ , we write  $r = \rho(K, \partial D)$ , and we shall show that  $\widehat{K}_{\mathcal{O}(D)} \subset \{z \in D : \rho(z, \partial D) \geq r\} = D_r$ ; this will prove everything.

Let  $a \in D \setminus D_r$  be an arbitrary point and let  $r_1 = \rho(a, \partial D) < r$ . Then there is a  $\mu > 1$  such that  $K \cup \{a\} \subset G_{\mu-1}$  and  $\rho(a, \partial G_{\mu}) < \rho(K, \partial G_{\mu})$ . By Theorem 3 of subsection 34 it follows from this that  $a$  does not belong to  $\widehat{K}_{\mu} = \widehat{K}_{\mathcal{O}(G_{\mu})}$ , and hence, there is a function  $f_0 \in \mathcal{O}(G_{\mu})$  such that  $|f_0(a)| > \|f_0\|_K$ . Multiplying it by a suitable constant, we may assume that

$$|f_0(a)| > c + 1, \quad \text{but } \|f_0\|_K < c - 1, \tag{8}$$

where  $c > 1$ . According to (7) the function  $f_0$  is holomorphic in a neighborhood of  $G_{\mu-1}^* = (\widehat{G_{\mu-1}})_{\mathcal{O}(G_{\mu+1})}$  and by Theorem 2 it can be approximated uniformly on  $G_{\mu-1}^*$  by functions from  $\mathcal{O}(G_{\mu+1})$ , i.e., there is a function  $f_1 \in \mathcal{O}(G_{\mu+1})$  such that  $\|f_1 - f_0\|_{G_{\mu-1}^*} < \frac{1}{2}$ . Now we proceed by induction: we assume that we have constructed functions  $f_j \in \mathcal{O}(G_{\mu+j})$ ,  $1 \leq j \leq k$ , for which

$$\|f_j - f_{j-1}\|_{G_{\mu+j-2}^*} < \frac{1}{2^j}. \tag{9}$$

Since, according to (7), the function  $f_k$  is holomorphic in a neighborhood of  $G_{\mu+k-1}^*$ , then by Theorem 2 there is a function  $f_{k+1} \in \mathcal{O}(G_{\mu+k+1})$ , for which condition (9) with  $j = k + 1$  is satisfied. This proves the existence of the sequence  $f_j$ .

By construction, for any  $k \geq 0$  the series

$$f_k + \sum_{j=k+1}^{\infty} (f_j - f_{j-1}) \tag{10}$$

consists of functions that are holomorphic in  $G_{\mu+k}$ , and it converges uniformly on  $G_{\mu+k-1}^*$ . Since its sum  $f$  obviously does not depend on  $k$ , and



since the sets  $G_{\mu+k-1}^*$  exhaust the domain  $D$ , then  $f \in \mathcal{O}(D)$ . Moreover, in view of (8) and (9),

$$|f(a)| \geq |f_0(a)| - \sum_{j=1}^{\infty} |f_j - f_{j-1}| > c,$$

$$\|f\|_K \leq \|f_0\|_K + \sum_{j=1}^{\infty} \|f_j - f_{j-1}\|_K < c,$$

and hence  $a \notin \widehat{K}_{\mathcal{O}(D)}$ . Since  $a$  is an arbitrary point of  $D \setminus D_r$ , then  $\widehat{K}_{\mathcal{O}(D)} \subset D_r$ . ►

In conclusion, we shall prove a simple but important fact, establishing the invariance of domains of holomorphy under biholomorphic mappings.

**THEOREM 4.** *If  $D \subset \mathbb{C}^n$  is a domain of holomorphy and  $D^*$  is its image under a biholomorphic mapping  $\varphi$ , then  $D^*$  is also a domain of holomorphy.*

◀ Let  $K^* \subset\subset D^*$ . Then since  $\varphi$  is a homeomorphism we have  $K = \varphi^{-1}(K^*) \subset\subset D$ , and since  $D$  is a domain of holomorphy, then  $\widehat{K}_{\mathcal{O}(D)} \subset\subset D$ .

It is easy to see that

$$\varphi(\widehat{K}_{\mathcal{O}(D)}) \supset \widehat{K}_{\mathcal{O}(D^*)}^*. \quad (11)$$

In fact, if some point  $w \in D^* \setminus \varphi(\widehat{K}_{\mathcal{O}(D)})$ , then  $z = \varphi^{-1}(w) \in D \setminus \widehat{K}$  and there is a function  $f \in \mathcal{O}(D)$  such that  $|f(z)| > \|f\|_K$ . We write  $g = f \circ \varphi^{-1}$ . Obviously,  $g \in \mathcal{O}(D^*)$  and  $|g(w)| > \|g\|_{K^*}$ , and this means that  $w \in D^* \setminus \widehat{K}_{\mathcal{O}(D^*)}^*$ .

From  $\widehat{K}_{\mathcal{O}(D)} \subset\subset D$  we conclude that  $\varphi(\widehat{K}_{\mathcal{O}(D)}) \subset\subset D^*$ , and by (11),  $\widehat{K}_{\mathcal{O}(D^*)}^* \subset\subset D^*$ . Thus,  $D^*$  is holomorphically convex, and hence, is a domain of holomorphy. ►

### §13. Pseudoconvexity

Here we shall introduce another interpretation of the concept of holomorphic convexity which has two essential merits: first, this concept can be formulated locally (and in this form it is easily verified), and, second, it is expressed naturally in geometric terms.

**36. The continuity principle.** We start with a theorem on forced analytic extension. To state it we define an  $m$ -dimensional *holomorphic surface*  $S$  in  $\mathbb{C}^n$  to be the image of some domain  $G \subset \mathbb{C}^m$  ( $m < n$ ) under a nondegenerate holomorphic mapping

$$\varphi: G \rightarrow \mathbb{C}^n. \quad (1)$$

In particular, for  $m = 1$   $S$  is a *holomorphic curve*, and if  $G \subset \mathbb{C}$  is a disc and  $\varphi$  is continuous in  $\overline{G}$ , then  $S = \varphi(\overline{G})$  is called a *holomorphic disc*. Recall that a mapping (1) is said to be *nondegenerate* if the rank of the Jacobi

matrix  $(\frac{\partial \varphi_\mu}{\partial z_\nu})$  is equal to  $m$  at all points of  $G$ . The surface (1) is said to be *bounded* if the set  $S = \varphi(G)$  is bounded in  $\mathbb{C}^n$ .

For bounded holomorphic surfaces the following maximum modulus principle is valid.

*If  $f$  is a function that is holomorphic in some open set  $U \subset \mathbb{C}^n$  that contains a bounded holomorphic surface  $S$  and if  $f$  is continuous in its closure  $\bar{S}$  (in the topology of  $\mathbb{C}^n$ ), then*

$$\sup_S |f| \leq \sup_{\partial S} |f|, \tag{2}$$

where  $\partial S = \bar{S} \setminus S$ .

In fact, if  $\sup_{\bar{S}} |f| > \sup_{\partial S} |f|$  at some point  $b \in S$ , then there is a point  $a \in \varphi^{-1}(b) \subset G$  at which the modulus of the function  $f \circ \varphi$ , which is holomorphic in  $G$ , attains a maximum. But then  $f \equiv \text{const}$  on  $\bar{S}$ , and this contradicts the choice of the point  $b$ .

Next we shall say that a sequence of sets  $M_\nu$  converges to a set  $M$  (notation:  $M_\nu \rightarrow M$ ) if, for any  $\varepsilon > 0$ , there is a  $\nu_0$  such that for all  $\nu \geq \nu_0$  we have

$$M_\nu \subset M^{(\varepsilon)} \quad \text{and} \quad M \subset M_\nu^{(\varepsilon)}, \tag{3}$$

where  $M^{(\varepsilon)}$  and  $M_\nu^{(\varepsilon)}$  denote the  $\varepsilon$ -dilations of the sets  $M$  and  $M_\nu$ , respectively (i.e., the union of all polydiscs  $U(z, \varepsilon)$  with centers at points of the sets).

**THEOREM (Behnke-Sommer).** *Let  $S_\nu$  be a sequence of bounded holomorphic surfaces which, together with the boundaries  $\partial S_\nu$ , are contained in a domain  $D \subset \mathbb{C}^n$ . If  $S_\nu$  converges to some set  $S$ ,  $\partial S_\nu$  converges to a set  $\Gamma$ , and  $\Gamma \subset\subset D$  (see Figure 37), then any function  $f \in \mathcal{O}(D)$  extends holomorphically to some neighborhood of the set  $S$ .*

◀ Since  $\Gamma \subset\subset D$ , then there exists a domain  $G \subset\subset D$  such that  $\Gamma \subset\subset G$ ; we let  $\rho(G, \partial D) = r$ . Because of the convergence  $\partial S_\nu \rightarrow \Gamma$  there is a  $\nu_0$  such that for  $\nu \geq \nu_0$

$$\partial S_\nu \subset G. \tag{4}$$

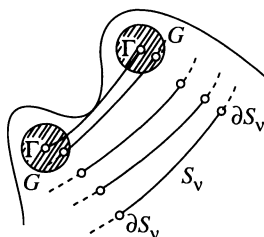

FIGURE 37

For any  $f \in \mathcal{O}(D)$  and any point  $z \in S_\nu$ , by the maximum modulus principle we have

$$|f(z)| \leq \|f\|_{\partial S_\nu},$$

and hence, by (4), for  $\nu \geq \nu_0$  we have

$$|f(z)| \leq \|f\|_G.$$

But this means that  $z$ , and hence the entire surface  $S_\nu$  for  $\nu \geq \nu_0$  belongs to the convex hull  $\widehat{G}_{\mathcal{O}(D)}$ . By the lemma on simultaneous extension (subsection 34) it follows from this that any function  $f \in \mathcal{O}(D)$  extends holomorphically into the  $r$ -dilation  $S_\nu^{(r)}$  of all the surfaces  $S_\nu$  for  $\nu \geq \nu_0$ .

Finally, since  $S_\nu \rightarrow S$  there is a  $\nu_1 \geq \nu_0$  such that  $S \subset S_\nu^{(r/2)}$  for all  $\nu \geq \nu_1$ , and hence any  $f \in \mathcal{O}(D)$  extends holomorphically into the  $r/2$ -dilation of the set  $S$ . ►

REMARK. As we see from the proof, in the Behnke-Sommer theorem the class  $\mathcal{O}(D)$  can be replaced by the class of functions that are holomorphic only in the intersection of  $D$  with some neighborhood of the limit set  $S \cup \Gamma$ .

The Behnke-Sommer theorem is called the *continuity principle*.<sup>(19)</sup> Relatively speaking, it states that the property of a function to be holomorphic in a neighborhood of the holomorphic surfaces  $S_\nu$  is also preserved for the limit set of these surfaces.

As an example of how the continuity principle is applied we prove a lemma that we shall need in the following section in the study of the extension of holomorphic functions in tube domains.

LEMMA. Let  $x^0, x^1, x^2$  be three points in  $\mathbb{R}^n(x)$  that do not lie on the same line, let  $l_1 = [x^0, x^1]$  and  $l_2 = [x^0, x^2]$  be closed intervals, and let  $\Delta = x^0 x^1 x^2$  be a closed triangle. If the function  $f$  is holomorphic in a neighborhood of the set  $(l_1 \cup l_2) \times \mathbb{R}^n(y)$ , then it extends holomorphically to a neighborhood of the set  $\Delta \times \mathbb{R}^n(y)$ .

In other words, every function  $f$  that is holomorphic in a neighborhood of the union of two faces of a triangular prism (Figure 38) must extend holomorphically into a neighborhood of the whole prism.

◀ Without loss of generality we may assume that  $x^0 = (0, 0, \dots, 0)$ ,  $x^1 = (1, 1, 0, \dots, 0)$ , and  $x^2 = (-1, 1, 0, \dots, 0)$ , since this can be arrived at by a linear transformation of  $\mathbb{C}^n(z)$  with real coefficients.<sup>(20)</sup> It suffices to prove that  $f$  extends holomorphically to any point of the set  $M = \Delta \times \mathbb{R}^n(y)$ . We may assume that  $a$  lies in the intersection of  $M$  and

<sup>(19)</sup>The special case of the Behnke-Sommer theorem where the  $S_\nu$  are closed subsets of the complex lines  $'z = 'a_\nu$  and  $S$  is a closed subset of the line  $'z = 'a = \lim_{\nu \rightarrow \infty} 'a_\nu$  was already proved by Hartogs, and is known as Hartogs's continuity theorem.

<sup>(20)</sup>Such a transformation takes  $\mathbb{R}^n(x)$  into itself and disturbs neither the hypotheses nor the assertion of the lemma.

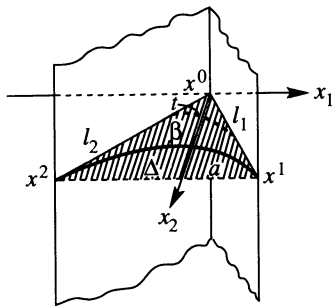

FIGURE 38

the real subspace  $\{y = 0\}$ , i.e., in the triangle  $\Delta$  (this can be done by a translation by a vector with purely imaginary coordinates).

Thus, we must prove that  $f$  extends holomorphically to any point  $a = (a_1, a_2, 0, \dots, 0)$ , where  $a_1, a_2$  are real numbers that satisfy the condition  $|a_1| < a_2 \leq 1$  (for our location of the axes this condition is that  $a \in \Delta \setminus (l_1 \cup l_2)$ ; for  $a \in l_1 \cup l_2$  the function  $f$  is holomorphic by assumption). For the proof we take the parabola

$$x_2 = \alpha x_1^2 + \beta \tag{5}$$

through the points  $x^1, a$ , and  $x^2$  (for this we must take  $\alpha = (1 - a_2)/(1 - a_1^2)$  and  $\beta = 1 - \alpha$ ; for  $a_2 = 1$  the parabola degenerates into the line  $x_2 = 1$ ) and for any  $t, 0 < t \leq \beta$ , we consider the holomorphic curve

$$S_t = \{z \in M : z_2 = \alpha z_1^2 + t, z_3 = \dots = z_n = 0\}. \tag{6}$$

We consider the variable  $z_1$  as a parameter on  $S_t$ . In order to prove that  $S_t$  is bounded, it suffices to show that for  $z \in S_t$  the values of  $z_1$  vary in a bounded domain of the  $z_1$ -plane. But the projection of  $S_t$  onto the  $z_1$ -plane is determined by the condition  $(\operatorname{Re} z_1, \operatorname{Re} z_2, 0, \dots, 0) \in \Delta$ , which is written in the form

$$|x_1| < \alpha(x_1^2 - y_1^2) + t \leq 1 \tag{7}$$

and distinguishes a bounded domain contained between the hyperbolae

$$\left(x_1 \pm \frac{1}{2\alpha}\right)^2 - y_1^2 = \frac{1}{4\alpha^2} - \frac{t}{\alpha}$$

(this domain is shaded in Figure 39 on the next page). We also notice that the curves  $S_t$  for  $0 < t \leq \beta$  intersect  $\mathbb{R}^n(x)$  in the segment of the parabola

$$x_2 = \alpha x_1^2 + t \tag{8}$$

that belongs to  $\Delta$ , parallel to the parabola (5) (shown by a dashed line in Figure 38).

We denote by  $E$  the set of  $t \in (0, \beta]$  such that  $f$  extends holomorphically to a neighborhood of  $S_t$ ; this is obviously an open set. It is not empty,

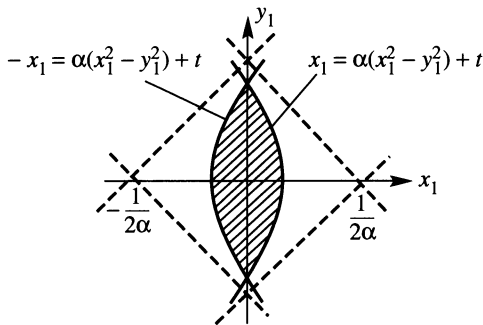

FIGURE 39

since for sufficiently small  $t > 0$  the domain (7) of variation of  $z_1$ , as seen from Figure 39, lies in an arbitrarily small neighborhood of  $z_1$ , and hence,  $S_t$  lies in an arbitrarily small neighborhood of  $z = 0$ , where  $f$  is holomorphic by hypothesis. But the set  $E$  is also closed. In fact, if  $t_0 \in (0, \beta]$  is a limit point of  $E$ , then there exists a sequence  $S_{t_\nu} \rightarrow S_{t_0}$ ,  $t_\nu \in E$ , for which  $\partial S_{t_\nu} \rightarrow \partial S_{t_0}$  and  $f$  is holomorphic in a neighborhood of all the  $S_{t_\nu}$  and  $\partial S_{t_0}$  (note that for any  $t \in (0, \beta]$ ,  $\partial S_t$  belongs to the set  $(I_1 \cup I_2) \times \mathbb{R}^n(y)$ , where  $f$  is holomorphic by hypothesis). Consequently, we can apply the continuity principle (see the remark following the proof of this principle) and conclude that  $t_0 \in E$ . Thus,  $E \equiv (0, \beta]$ , and hence  $f$  extends holomorphically into a neighborhood of  $S_\beta$ , but  $S_\beta$  contains the point  $a$ .  $\blacktriangleright$

**37. Local pseudoconvexity.** Ordinary (geometric) convexity of a domain  $D = \{x \in \mathbb{R}^n : \varphi(x) < 0\}$  with a boundary of class  $C^2$  at a boundary point  $a$  is: in a sufficiently small neighborhood  $U$  of  $a$  the domain  $D$  lies to one side of the tangent plane  $T = T_a(\partial D)$ . Without loss of generality we may assume that  $a = 0$  and then the Taylor expansion of  $\varphi$  at 0 has the form

$$\varphi(x) = L_0(x) + \frac{1}{2}H_0(x) + o(|x|^2), \tag{1}$$

where  $L_0$  is the set of linear terms, and

$$H_0(x) = \sum_{\mu, \nu=1}^n \frac{\partial^2 \varphi}{\partial x_\mu \partial x_\nu} \Big|_0 x_\mu x_\nu. \tag{2}$$

Since the linear terms  $L_0(x) \equiv 0$  on  $T$ , convexity is determined by the restriction to  $T$  of the quadratic form  $H_0$ : if  $D$  is convex at the point 0, then  $H_0(x)|_T \geq 0$ , and if  $H_0(x)|_T > 0$  for  $x \neq 0$ , then  $D$  is convex.

Local pseudoconvexity arises in the construction of the complex analogue of this criterion. Suppose that a domain  $D \subset \mathbb{C}^n$  in a neighborhood  $U$  of a boundary point  $a$  is given by the condition

$$D \cap U = \{z \in U : \varphi(z) < 0\}, \tag{3}$$

where  $\varphi \in C^2(U)$  and  $\nabla_z \varphi = (\frac{\partial \varphi}{\partial z_1}, \dots, \frac{\partial \varphi}{\partial z_n})_z \neq 0$  for all  $z \in U$ ; a func-

tion  $\varphi$  with these properties is said to *locally define* the domain  $D$  in the neighborhood  $U$ .

It is not difficult to see that two such functions  $\varphi$  and  $\psi$  differ by a positive factor  $h \in C^1(U)$  if  $U$  is sufficiently small. In fact, by the division lemma (subsection 31) there is a function  $h \in C^1(U)$  such that  $\psi = h\varphi$ , and since  $\varphi$  and  $\psi$  are both negative in  $U \cap D$  and positive in  $U \setminus \overline{D}$ , then  $h > 0$  in  $U \setminus \partial D$ . But  $h \neq 0$  on  $\partial D$  as well, since again by the division lemma we have  $\varphi = h_1\psi$ , where  $h_1 = 1/h \in C^1(U)$ , and therefore  $h > 0$  everywhere in  $U$ .

\* Let  $\varphi$  be a local defining function of a domain  $D$  in a neighborhood  $U$ . Prove that if  $U$  is sufficiently small, then any form  $\omega \in C^k(U)$  that vanishes on  $\partial D \cap U$  can be represented as  $\omega = \varphi\omega_1$ , where  $\omega_1 \in C^{k-1}(U)$  is some form. \*

The Taylor expansion of  $\varphi$  in a neighborhood of the point  $a = 0$  has the form

$$\varphi(z) = 2\text{Re } L_0(z) + \text{Re } K_0(z) + \frac{1}{2}H_0(z) + o(|z|^2), \tag{4}$$

where

$$\begin{aligned} L_0(z) &= \sum_{\nu=1}^n \frac{\partial \varphi}{\partial z_\nu} \Big|_0 z_\nu, & K_0(z) &= \sum_{\mu, \nu=1}^n \frac{\partial^2 \varphi}{\partial z_\mu \partial z_\nu} \Big|_0 z_\mu z_\nu, \\ H_0(z) &= \sum_{\mu, \nu=1}^n \frac{\partial^2 \varphi}{\partial z_\mu \partial \bar{z}_\nu} \Big|_0 z_\mu \bar{z}_\nu. \end{aligned} \tag{5}$$

To obtain this it suffices to write the Taylor expansion of  $\varphi$  with respect to the variables  $z_\nu, \bar{z}_\nu$  and to note that since  $\varphi$  is real the groups of terms with derivatives in the  $\bar{z}_\nu$  are complex conjugate to the corresponding terms with derivatives in the  $z_\nu$  and in the sum they give double real parts.

We see that in contrast to (1) the second-order terms in the expansion (4) are divided into two groups:  $\text{Re } K_0(z)$  and  $\frac{1}{2}H_0(z)$ . We write the second of these in a somewhat different way:

$$H_z(\varphi, \omega) = \sum_{\mu, \nu=1}^n \frac{\partial^2 \varphi}{\partial z_\mu \partial \bar{z}_\nu} \Big|_z \omega_\mu \bar{\omega}_\nu, \tag{6}$$

and call it the *Levi form* of the function  $\varphi$  at  $z$ . Since  $\varphi$  is real this form is Hermitian ( $\partial^2 \varphi / \partial z_\mu \partial \bar{z}_\nu = \overline{\partial^2 \varphi / \partial z_\nu \partial \bar{z}_\mu}$ ) and hence it takes real values on all vectors  $\omega \in \mathbb{C}^n$ . The following properties of the Levi form are checked directly:

(a) If  $h \in C^2$  in a neighborhood of the point  $z$  and is real, then

$$H_z(h\varphi, \omega) = hH_z(\varphi, \omega) + \varphi H_z(h, \omega) + 2\text{Re } \partial\varphi(\omega) \overline{\partial h(\omega)}, \tag{7}$$

where  $\partial\varphi(\omega) = \sum_{\nu=1}^n \frac{\partial \varphi}{\partial z_\nu} \omega_\nu$  and  $\partial h(\omega)$  is understood analogously.

(b) If  $\psi \in C^2$  in a neighborhood of the point  $\varphi(z)$  is a real function of the variable  $\varphi$ , then

$$H_z(\psi \circ \varphi, \omega) = \psi'(\varphi)H_z(\varphi, \omega) + \psi''(\varphi)|\partial\varphi(\omega)|^2. \tag{8}$$

(c) If  $f: U \rightarrow \mathbb{C}^m$  is a holomorphic mapping and  $\psi \in C^2$  in a neighborhood of the point  $f(z)$ , then

$$H_z(\psi \circ f, \omega) = H_{f(z)}(\psi, f_*\omega), \quad (9)$$

where  $f_* = df$  is the differential of the mapping  $f$  at  $z$ .

The last property shows that the Levi form is invariant relative to biholomorphic mappings. The form  $K_0$  does not possess the invariance property; moreover, by a suitable biholomorphic mapping it can be completely removed.

**LEMMA.** *If the boundary of the domain  $D$  is  $C^2$  close to the point  $a$ , then there exists a biholomorphic mapping  $f$ ,  $f(a) = 0$ , of a neighborhood  $U \ni a$  such that  $G = f(D \cap U)$  in a neighborhood of the point  $w = 0$  has a defining function with Taylor expansion*

$$\psi(w) = \operatorname{Re} w_n + \frac{1}{2}H_0(\psi, w) + o(|w|^2). \quad (10)$$

◀ Let the point  $a = 0$  and in a neighborhood of it suppose there exists a local defining function of the domain  $D$ ; suppose this is the function  $\varphi$  with the Taylor expansion (4). In a neighborhood  $U \ni 0$  we choose new coordinates  $w$  such that  $w_1, \dots, w_{n-1}$  will be coordinates in the complex tangent plane  $\{L_0(z) = 0\}$ , and  $w_n = L_0(z) + \frac{1}{2}K_0(z)$ . Since  $K_0$  consists of quadratic terms, then the mapping  $w = f(z)$  is biholomorphic if  $U$  is sufficiently small.

The image  $G = f(D \cap U)$  is defined by the inequality  $\psi(w) < 0$ , where  $\psi = \varphi \circ f^{-1}$ , and substituting  $z = f^{-1}(w)$  in the expansion (5), which can be rewritten as

$$\varphi(z) = 2\operatorname{Re} f_n(z) + \frac{1}{2}H_0(\varphi, z) + o(|z|^2),$$

we will obtain

$$\psi(w) = 2\operatorname{Re} w_n + \frac{1}{2}H_0(\psi, w) + o(|w|^2)$$

on the basis of (9). ▶

Thus, among the second-order terms of the Taylor expansion of a local defining function the more important one in complex analysis is the Levi form. In fact it lies at the heart of the complex analogue of convexity: instead of the restrictions of the whole group of second-order terms to the tangent plane  $T_a(\partial D)$  we consider the restriction of the Levi form to the complex tangent plane  $T_a^c(\partial D)$ .

**DEFINITION 1.** A domain  $D$  with a  $C^2$  boundary in a neighborhood of a point  $a$  is said to be *pseudoconvex at  $a$*  if in a neighborhood of  $a$  there exists a local defining function  $\varphi$  of the domain  $D$  such that

$$H_a(\varphi, \omega) \geq 0 \quad \text{for all } \omega \in T_a^c(\partial D), \quad (11)$$

and *strictly pseudoconvex* if

$$H_a(\varphi, \omega) > 0 \quad \text{for all } \omega \in T_a^c(\partial D), \quad \omega \neq 0. \quad (12)$$

Here are some examples.

1. The polydisc  $U^n = \{z \in \mathbb{C}^n : \|z\| < 1\}$ . At points  $a \in \partial U^n$  belonging to the faces  $S_\nu = \{|z_\nu| = 1\}$ , but not to the skeleton  $\Gamma$ , we can take  $\varphi(z) = z_\nu \bar{z}_\nu - 1$  as a defining function. The Levi form  $H_a(\varphi, \omega) = |\omega_\nu|^2$  is non-negative, but it vanishes on vectors  $\omega$  for which  $\omega_\nu = 0$ , i.e., exactly on the complex tangent plane  $T_a^c(\partial U^n)$  (the equation of the latter is  $\bar{a}_\nu(z_\nu - a_\nu) = 0$  or  $\bar{a}_\nu \omega_\nu = 0$ , and  $a_\nu \neq 0$ , so that  $\omega_\nu = 0$ ). Therefore at such points the polydisc is a pseudoconvex domain but is not strictly pseudoconvex.

2. The ball  $B^n = \{z \in \mathbb{C}^n : |z| \leq 1\}$ . Here for any point  $a \in \partial B^n$  the defining function is  $\varphi(z) = \sum_{\nu=1}^n z_\nu \bar{z}_\nu - 1$ , its Levi form  $H_a(\varphi, \omega) = \sum_{\nu=1}^n \omega_\nu \bar{\omega}_\nu = |\omega|^2 > 0$  for  $\omega \neq 0$ . Hence, the ball is strictly pseudoconvex at all boundary points.

\* Prove that: (1) any (strictly) convex domain  $D \subset \mathbb{C}^n$  at a point is (strictly) pseudoconvex at this point, but the converse is false; (2) the domain  $\{z \in \mathbb{C}^2 : |z_1|^2 + |z_2|^4 < 1\}$  is strictly pseudoconvex at all points of  $\partial D$  except for the circle  $\{|z_1| = 1, z_2 = 0\}$ , where it is pseudoconvex. \*

It is not difficult to see that the properties in the definition of pseudoconvexity and strict pseudoconvexity do not depend on the choice of a local defining function. In fact, since  $\varphi(a) = 0$  and  $\partial\varphi(\omega) = 0$  for all  $\omega \in T_a^c(\partial D)$ , then for another defining function  $\psi = h\varphi$  by formula (7) we have<sup>(21)</sup>

$$H_a(\psi, \omega) = h(a)H_a(\varphi, \omega).$$

But by what was proved above  $h(a) > 0$ , so that the restrictions to  $T_a^c(\partial D)$  of the Levi form of the functions  $\varphi$  and  $\psi$  have the same signs.

**THEOREM 1.** *In a neighborhood of a point  $a$  of strict pseudoconvexity the domain  $D$  has a defining function whose Levi form is positive not only on the complex tangent plane  $T_a^c(\partial D)$ , but also for all  $\omega \neq 0$ .*

◀ In view of the strict pseudoconvexity in a neighborhood  $U$  of a point  $a \in \partial D$  there exists a defining function  $\varphi$  which satisfies condition (12). If  $U$  is sufficiently small, then in it the function  $\psi = \varphi + k\varphi^2$  will also be a defining function for any constant  $k \geq 0$  (in particular,  $\nabla\psi = \psi'(\varphi)\nabla\varphi \neq 0$ ). Since  $\varphi(a) = 0$ , then  $\psi'(a) = 1 + 2k\varphi = 1$  at this point, and by formula (8)

$$H_a(\psi, \omega) = H_a(\varphi, \omega) + 2k|\partial\varphi(\omega)|^2. \quad (13)$$

It suffices to prove that the form  $H_a(\psi, \omega)$  is positive on the sphere  $S = \{\omega \in \mathbb{C}^n : |\omega| = 1\}$ , since  $H_a(\psi, \lambda\omega) = |\lambda|^2 H_a(\psi, \omega)$ . Let  $S_0 = \{\omega \in S : H_a(\varphi, \omega) \leq 0\}$ ; if this set is empty, we can set  $k = 0$ . If it is not empty, then by the compactness there is a constant  $M \geq 0$  such that  $H_a(\varphi, \omega) \geq -M$  for all  $\omega \in S_0$ . By (12) for  $\partial\varphi(\omega) = 0$ , i.e., for  $\omega \in T_a^c(\partial D)$ ,  $H_a(\varphi, \omega) > 0$ ; hence, on  $S_0$  we have  $\partial\varphi(\omega) \neq 0$  and therefore there is a constant  $m > 0$

<sup>(21)</sup>Since  $\varphi(a) = 0$ , then formula (7) is also valid for functions  $h \in C^1(U)$ .



such that  $|\partial\varphi(\omega)| \geq m$  on  $S_0$ . If we take  $k > M/2m^2$ , then by (13) and our estimates on  $S_0$  we have

$$H_a(\psi, \omega) \geq -M + 2km^2 > 0,$$

and on  $S \setminus S_0$  the positivity of  $H_a(\psi, \omega)$  is obvious. ►

Since the Levi form  $H_z(\varphi, \omega)$  of a  $C^2$  function  $\varphi$  depends continuously on  $z$ , from Theorem 1 we get a

**COROLLARY.** *If the domain  $D$  is strictly pseudoconvex at a boundary point  $a$ , then in a sufficiently small neighborhood  $U$  of  $a$  there exists a defining function  $\varphi$  such that*

$$H_z(\varphi, \omega) > 0 \quad \text{for all } z \in U \text{ and } \omega \in \mathbb{C}^n \setminus \{0\}. \quad (14)$$

Theorem 1 also yields an assertion that establishes a connection between strict pseudoconvexity and geometric convexity.

**THEOREM 2.** *If the domain  $D$  is strictly pseudoconvex at a boundary point  $a$ , then there exists a biholomorphic mapping of some neighborhood  $U \ni a$ , taking  $\partial D \cap U$  into pieces of the boundary of a geometrically convex domain.*

◄ Let  $a = 0$  and let  $\varphi$  be a local defining function of the domain  $D$ , as in Theorem 1. Carrying out the biholomorphic transformation  $f: U \rightarrow \mathbb{C}^n$  described in the Lemma (see above), we find that the function  $\psi = \varphi \circ f^{-1}$ , defining the domain  $D$  in a neighborhood of the point  $f(0) = 0$ , has the Taylor expansion (10), in which all the second-order terms are reduced to

$$\frac{1}{2}H_0(\psi, w) = \frac{1}{2}H_0(\varphi, f_*^{-1}w).$$

By Theorem 1 this form is positive for all  $w \neq 0$ , and hence its restriction to the (real) tangent plane to  $f(\partial D \cap U)$  at points sufficiently close to  $w = 0$  is also positive. But this means that  $D$  is geometrically convex. ►

Pseudoconvexity and strict pseudoconvexity possess an essential advantage over holomorphic convexity: these properties are local and thus can be verified efficiently. However, in contrast to holomorphic convexity they can only claim to give a LOCAL characterization of domains of holomorphy.

**DEFINITION 2.** A domain  $D$  is said to be *not holomorphically extendable* at a boundary point  $a$  if there exists a neighborhood  $U_a$  of  $a$  and a function  $f$ , holomorphic on the open set  $U_a \cap D$ , that does not have a holomorphic extension to the point  $a$ .

It is clear that any domain of holomorphy is not holomorphically extendable at any point of  $\partial D$ . As long ago as 1910 E. Levi raised the converse problem:

**LEVI PROBLEM.** *Is a domain  $D$  that is not holomorphically extendable at a single point of the boundary a domain of holomorphy?*

The main difficulty in this problem is the passage from a local property to a global one. If  $D$  is not holomorphically extendable at a point  $a \in \partial D$ , then

there exists a local barrier, a function  $f_a(z)$ , holomorphic in  $U_a \cap D$  that does not have a holomorphic extension to  $a$ . But how does one construct a global barrier, i.e., a function that is holomorphic in the entire domain  $D$  and does not extend to  $a$ ? This difficulty was overcome only in 1953 by K. OKA, who proved that the Levi problem has a positive solution for any domain  $D \subset \mathbb{C}^n$ . We shall speak about the solution of this problem in the following chapter.

However, the local question of the holomorphic nonextendability of domains turns out to be simple and is solved in terms of local pseudoconvexity.

**THEOREM 3 (Levi-Krzoska).**<sup>(22)</sup> *If a domain  $D$  with a  $C^2$  boundary in a neighborhood of a point  $a$  is strictly pseudoconvex at this point, then  $D$  is not holomorphically extendable at this point. Conversely, if  $D$  is not holomorphically extendable at a point  $a$ , then it is pseudoconvex at this point.*

◀ Let  $a = 0$  and let  $\varphi$  be a local defining function for the domain at  $a$ . Without loss of generality we may assume that the linear part of the Taylor expansion of  $\varphi$  at the point  $z$  is equal to 0, i.e.,  $L_0(z) = z_n/2$ ; the general case reduces to this case by a nondegenerate linear transformation that changes neither the hypotheses nor the assertions of the theorem. Then, according to (4), this expansion has the form

$$\varphi(z) = \operatorname{Re}(z_n + K_0(z)) + \frac{1}{2}H_0(z) + o(|z|^2), \quad (15)$$

and the complex tangent plane  $T_0^c(\partial D) = \{z_n = 0\}$ .

(a) Suppose  $D$  is strictly pseudoconvex at the point  $a = 0$ . Then, as in the proof of Theorem 1, we can replace  $\varphi$  by the function  $\varphi + k\varphi^2$  with a suitable constant  $k$ , such that the Levi form  $H_0(z)$  becomes positive not only on  $T_0^c$ , but also for all  $z \neq 0$ , and this replacement does not change the form (15) of the expansion of  $\varphi$ . But then, by homogeneity,

$$H_0(z) = |z|^2 H_0(z/|z|) \geq m|z|^2,$$

where  $m > 0$  is the minimum of  $H_0$  on the sphere  $\{|z| = 1\}$ .

We now consider the holomorphic function  $f(z) = z_n + K_0(z)$ ; according to (15) on its zero level set  $\{f(z) = 0\}$  we have

$$\varphi(z) = \frac{1}{2}H_0(z) + o(|z|^2) \geq \frac{m}{2}|z|^2 + o(|z|^2) > 0$$

if  $|z|$  is sufficiently small. Thus, the level set  $\{f(z) = 0\}$  passing through  $a = 0$ , in a sufficiently small neighborhood  $U \ni 0$  lies wholly outside the domain  $D$ . We conclude that the function  $1/f$  is holomorphic in  $D \cap U$  but does not extend holomorphically to the point  $a = 0$ , i.e., that  $D$  is not holomorphically extendable at this point.

<sup>(22)</sup>For  $n = 2$  the theorem was proved in 1909 by E. LEVI and the general case occurs in the dissertation of Krzoska (1933).

(b) Suppose that  $D$  is not pseudoconvex at the point  $a = 0$ . Then there exists a vector  $\omega \in T_0^c$ , i.e.,  $\omega = ({}^1\omega, 0)$  such that  $H_0(\omega) < 0$ . We consider the holomorphic curve  $S_0$  which is obtained as the section of the surface  $\{z_n + K(z) = 0\}$  by the complex two-dimensional plane passing through the  $z_n$ -axis and the vector  $\omega$ . This curve can be given using a complex parameter  $\zeta$  by the equations

$${}^1z = {}^1\omega\zeta, \quad z_n = g(\zeta) = \alpha\zeta^2 + o(|\zeta|^2)$$

(we have taken into account that  $S_0$  is tangent to the vector  $\omega$  at the point  $z = 0$ ). As in the first part of the proof, we will find that  $\varphi|_{S_0} = \frac{1}{2}H_0(\omega)|\zeta|^2 + o(|\zeta|^2)$ . Since  $H_0(\omega) < 0$ , then for sufficiently small  $|\zeta|$ , say for  $|\zeta| \leq \delta$ , all the points of the curve  $S_0$  except for  $z = 0$  now lie in the domain  $D$ .

It is clear that for sufficiently small  $t > 0$  the bounded holomorphic discs  $S_t = \{z = {}^1\omega\zeta, z_n = g(\zeta) - t : |\zeta| \leq \delta\}$  belong completely to the domain  $D$ , and  $S_t \rightarrow S_0$  and  $\partial S_t \rightarrow \partial S_0$  as  $t \rightarrow 0$ . By the continuity principle (see subsection 36) it follows from this that  $D$  is not holomorphically nonextendable at the point  $z = 0$ . ►

**COROLLARY.** Let  $\varphi \in C^2$  be a real function in a neighborhood of a point  $a \in \mathbb{C}^n$ ,  $\varphi(a) = 0$ , and suppose that the Levi form  $H_a(\varphi, \omega)$  on the complex tangent plane  $T_a^c(S)$ , where  $S = \{\varphi(z) = 0\}$ , has at least one negative eigenvalue (i.e., there exists a vector  $\omega \in T_a^c(S)$  such that  $H_a(\varphi, \omega) < 0$ ). Then any function  $f$  that is holomorphic in the part of a neighborhood of  $S$  where  $\varphi < 0$  has a holomorphic extension to the point  $a$ .

◀ This fact is proved in part (b) of the proof of the Levi-Krzoska theorem. ►

**REMARK.** Suppose that the domain  $D$  at some boundary point  $a$  can be tangent from the exterior to a complex hypersurface  $A = \{f(z) = 0\}$ ; this means that  $f(a) = 0$ , but in some neighborhood  $U_a$  the surface  $A$  lies outside of  $D$ . Then  $D$  is not holomorphically extendable at the point  $a$  (the function  $1/f$  cannot be extended), and hence, by the previous theorem, is pseudoconvex at this point. This sufficient condition for pseudoconvexity is similar to the criterion for geometric convexity (instead of  $A$  we must take a real hyperplane).

Until now we have considered domains with boundaries of class  $C^2$ ; however the concept of local pseudoconvexity can also be formulated in the general case. For this let us agree to say that a domain  $D$  at a boundary point  $a$  can be *tangent from the interior by a family of holomorphic discs* if there is a family of holomorphic discs  $S_t \subset\subset D$ ,  $0 < t \leq t_0$ , converging as  $t \rightarrow 0$  to a disc  $S$  such that  $S_t \rightarrow S$ ,  $\partial S_t \rightarrow \partial S$ , where  $\partial S \subset\subset D$ , and  $S$  contains the point  $a$  (Figure 40). We take the absence of this property as the definition of local pseudoconvexity in the case of domains with arbitrary boundaries.

**DEFINITION 3.** A domain  $D$  is said to be *pseudoconvex* at a boundary point

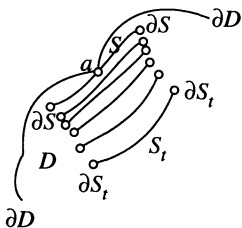

FIGURE 40

$a$ , if at  $a$  it cannot be tangent from the interior by a family of holomorphic discs.

In particular, if  $\partial D$  is  $C^2$  in a neighborhood of the point  $a$  and is pseudoconvex at this point in the sense of Definition 1, then it is pseudoconvex in the sense of Definition 3. In fact, in part (b) of the proof of the Levi-Krzoska theorem it is proved that if  $\partial D$  is not pseudoconvex at  $a$  in the sense of Definition 1, then at  $a$  it can be tangent from the interior by a family of holomorphic discs. We stress that the notion of strict pseudoconvexity implies that the boundary is  $C^2$ -smooth and does not extend to arbitrary domains.

**38. Plurisubharmonic functions.** In order to pass from local pseudoconvexity to global pseudoconvexity we need to introduce the concept of plurisubharmonicity. In the Appendix to Part I we noted that subharmonicity is the higher-dimensional analogue of the convexity of functions of one real variable. In fact, a function  $f: [\alpha, \beta] \rightarrow \mathbb{R}$  is convex (downwards) if for any  $x', x'' \in [\alpha, \beta]$  the best linear majorant of  $f$  on the interval  $[x', x'']$ , i.e., the function which at the point  $x = (1 - t)x' + tx''$  takes the value  $h(x) = (1 - t)f(x') + tf(x'')$ , satisfies the condition

$$f(x) \leq h(x) \quad \text{for all } x \in [x', x''].$$

(Recall that linear functions of one variable are the one-dimensional analogue of harmonic functions.)

Convex functions of several variables can be defined as those for which the restriction to any real line is a convex function of one variable. The condition for the convexity of a  $C^2$  function of one variable is that the second derivative be nonnegative, and by the chain rule, for the restriction of a function  $f$  of several variables of class  $C^2$  to the line  $x = x^0 + \omega t$  we have

$$\frac{d^2}{dt^2} f(x^0 + \omega t) = \sum_{\mu, \nu=1}^n \frac{\partial^2 f}{\partial x_\mu \partial x_\nu} \Big|_x \omega_\mu \omega_\nu.$$

Therefore the condition for the convexity of our function reduces to the nonnegativity of this quadratic form for all  $\omega \in \mathbb{R}^n$ .

Plurisubharmonic functions are the complex analogue of convex functions of several variables.

**DEFINITION 1.** A function  $\varphi: D \rightarrow [-\infty, \infty)$  is said to be *plurisubharmonic* in the domain  $D \subset \mathbb{C}^n$  if: (1) it is upper semicontinuous in  $D$ , and (2) for any point  $z^0 \in D$  and for any complex line  $z = l(\zeta) = z^0 + \omega\zeta$ , where  $\omega \in \mathbb{C}^n$ ,  $\zeta \in \mathbb{C}$ , the restriction of  $\varphi$  to this line, i.e., the function  $\varphi \circ l(\zeta)$ , is subharmonic on the open set  $\{\zeta \in \mathbb{C} : l(\zeta) \in D\}$ .

Recall that a real function  $\varphi$  in a domain  $D \subset \mathbb{C}^n$ , which can take the value  $-\infty$  but not  $\infty$ , is said to be upper semicontinuous in  $D$  if at each point  $z^0 \in D$

$$\overline{\lim}_{z \rightarrow z^0} \varphi(z) \leq \varphi(z^0), \quad (1)$$

or, in other words, if for any  $\varepsilon > 0$  there is a  $\delta = \delta(z^0, \varepsilon) > 0$  such that

$$|z - z^0| < \delta \Rightarrow \begin{cases} \varphi(z) - \varphi(z^0) < \varepsilon & \text{if } \varphi(z^0) \neq -\infty, \\ \varphi(z) < -1/\varepsilon & \text{if } \varphi(z^0) = -\infty. \end{cases} \quad (2)$$

A necessary and sufficient condition for upper semicontinuity is that for any  $\alpha \in (-\infty, \infty)$  the set of lower values  $\{z \in D : \varphi(z) < \alpha\}$  should be open. From the side of the upper values semicontinuous functions behave like continuous ones. In particular, on compact subsets  $K \subset\subset D$  they are bounded from above and attain their maximum values (boundedness from below and attainment of minimum values are not mandatory).

Important examples of plurisubharmonic functions are the logarithms of the modulus of holomorphic functions: if  $f \in \mathcal{O}(D)$ , then  $\varphi(z) = \ln|f(z)|$  is upper semicontinuous in  $D$  (it is continuous at the points where  $f(z) \neq 0$  and in the approximation to the zeros of  $f$  it tends to  $-\infty$ ), and its restriction to any complex line  $z = l(\zeta)$  is subharmonic as the logarithm of the modulus of the holomorphic function of one variable  $f \circ l$  (see the Appendix to Part I).

Subharmonic functions of class  $C^2$  are characterized by the condition that the Laplace operator  $\Delta = 4 \frac{\partial^2}{\partial \zeta \partial \bar{\zeta}}$  be nonnegative. And if the function  $\varphi$  is  $C^2$  in a domain  $D \subset \mathbb{C}^n$ , then by the chain rule, for its restriction to the complex line  $z = z^0 + \omega\zeta$  we have

$$\frac{\partial^2 \varphi(z^0 + \omega\zeta)}{\partial \zeta \partial \bar{\zeta}} = \sum_{\mu, \nu=1}^n \frac{\partial^2 \varphi}{\partial z_\mu \partial \bar{z}_\nu} \Big|_{z^0} \omega_\mu \bar{\omega}_\nu.$$

Thus, we obtain the following criterion.

**THEOREM 1.** For a function  $\varphi \in C^2(D)$  to be plurisubharmonic it is necessary and sufficient that at each point  $z \in D$  the form  $H_z(\varphi, \omega)$  satisfy

$$H_z(\varphi, \omega) = \sum_{\mu, \nu=1}^n \frac{\partial^2 \varphi}{\partial z_\mu \partial \bar{z}_\nu} \Big|_z \omega_\mu \bar{\omega}_\nu \geq 0 \quad \text{for all } \omega \in \mathbb{C}^n. \quad (3)$$

We again arrive at the Levi form, which was considered in the previous subsection in connection with the concept of pseudoconvexity of domains. We distinguish an important class of  $C^2$  plurisubharmonic functions that is connected with the concept of strict pseudoconvexity.

DEFINITION 2. A function  $\varphi$  is said to be *strictly plurisubharmonic* in a domain  $D \subset \mathbb{C}^n$  if (1)  $\varphi \in C^2(D)$  and (2) at each point  $z \in D$  the Levi form

$$H_z(\varphi, \omega) > 0 \quad \text{for all } \omega \in \mathbb{C}^n \setminus \{0\}. \quad (4)$$

REMARK. The Hermitian Levi form

$$H_z(\varphi, dz) = \sum_{\mu, \nu=1}^n \frac{\partial^2 \varphi}{\partial z_\mu \partial \bar{z}_\nu} dz_\mu d\bar{z}_\nu,$$

according to the standard rule that we discussed in subsection 18, corresponds to the differential form

$$\frac{i}{2} \sum_{\mu, \nu=1}^n \frac{\partial^2 \varphi}{\partial z_\mu \partial \bar{z}_\nu} dz_\mu \wedge d\bar{z}_\nu = dd^c \varphi.$$

According to the convention made in subsection 18 the (strict) plurisubharmonicity of a  $C^2$  function  $\varphi$  can be characterized by the (strict) positivity of the form  $dd^c \varphi$ .

The connection of plurisubharmonic functions with pseudoconvex domains will be considered in the following subsection. Here we shall only concentrate on the properties of these functions, and we shall be interested in functions that are not necessarily  $C^2$ , but in the general case only upper semicontinuous.

From Definition 1 we see that properties of plurisubharmonic functions reduce simply to properties of subharmonic functions. In particular, from the theorems proved in the Appendix to Part I, we immediately obtain the following assertions:

1°. If  $\varphi$  is a plurisubharmonic function in a domain  $D$  and  $\varphi$  attains a local maximum at some point  $z^0 \in D$ , then it is constant in  $D$ .

2°. A function that is plurisubharmonic in some neighborhood of each point  $z^0 \in D$  is plurisubharmonic in the domain  $D$ .

3°. If the upper envelope  $\varphi(z) = \sup_{\alpha \in A} \varphi_\alpha(z)$  of a family of functions  $\varphi_\alpha$ ,  $\alpha \in A$ , that are plurisubharmonic in a domain  $D$ , is upper semicontinuous in  $D$ , then it is plurisubharmonic in  $D$ .

4°. For an upper semicontinuous function  $\varphi$  to be plurisubharmonic in a domain  $D$  it is necessary and sufficient that for each point  $z \in D$  and each vector  $\omega \in \mathbb{C}^n$  there exist a number  $r_0 = r_0(z, \omega)$  such that

$$\varphi(z) \leq \frac{1}{2\pi} \int_0^{2\pi} \varphi(z + \omega r e^{it}) dt \quad (5)$$

for all  $r < r_0$  (CRITERION FOR PLURISUBHARMONICITY).

We also have the assertion

5°. For any function  $\varphi$  that is plurisubharmonic in a neighborhood of a point  $z^0 \in \mathbb{C}^n$  the value  $\varphi(z^0)$  does not exceed its mean value on the sphere

$\{|z - z^0| = r\}$  of sufficiently small radius  $r$  :

$$\varphi(z^0) \leq \frac{1}{\sigma(r)} \int_{\{|z - z^0| = r\}} \varphi(z) d\sigma, \tag{6}$$

where  $\sigma(r)$  is the area of this sphere and  $d\sigma$  is the area element.

◀ Without loss of generality we may assume that  $z^0 = 0$ . Then the mean value in the right-hand side of (6) can be rewritten in the form

$$S(r) = \int_{S_r} \varphi(z) \sigma_0, \tag{7}$$

where  $S_r = \{|z| = r\}$  and  $\sigma_0 = d^c \ln|z|^2 \wedge (dd^c \ln|z|^2)^{n-1} / \pi^n$  is the Poincaré form (see subsection 19). The integration in (7) can be carried out first over the intersection of  $S_r$  with the complex line  $l_\omega = \{z = \omega\zeta\}$ , i.e., over the circle  $\{|\zeta| = r\}$ , and then over the set  $\{l_\omega\} = \mathbb{P}^{n-1}$  of such lines (we assume that  $|\omega| = 1$ ). Since on  $l_\omega$  the form  $\frac{1}{\pi} d^c \ln|z|^2 = \frac{dt}{2\pi}$ , where  $t = \arg \zeta$  (see subsection 19), then

$$S(r) = \int_{\mathbb{P}^{n-1}} \frac{1}{\pi^{n-1}} (dd^c \ln|z|^2)^{n-1} \frac{1}{2\pi} \int_0^{2\pi} \varphi(\omega r e^{it}) dt. \tag{8}$$

By formula (5), in which  $z = 0$ , the inner integral is not less than  $\varphi(0)$ , and  $dd^c \ln|z|^2 / \pi = \omega_0$  is the normalized Fubini-Study form for  $\mathbb{P}^{n-1}$ . Therefore

$$S(r) \geq \varphi(0) \int_{\mathbb{P}^{n-1}} \omega_0^{n-1} = \varphi(0)$$

(here we have used Theorem 1 of subsection 19). ▶

From 5° as in Part I we derive

6°. Any plurisubharmonic function in a domain  $D \subset \mathbb{C}^n$  is a subharmonic function of  $2n$  real variables, i.e., for any point  $z^0 \in D$  and ball  $B = \{|z - z^0| < r\}$  of sufficiently small radius any function  $h$  that is harmonic<sup>(23)</sup> in  $B$  and continuous in  $\bar{B}$  possesses the property

$$\varphi|_{\partial B} \leq h|_{\partial B} \Rightarrow \varphi|_B \leq h|_B. \tag{9}$$

We also need the proposition:

7°. If the function  $\varphi$  is plurisubharmonic in a neighborhood of a point  $z^0 \in \mathbb{C}^n$ , then its mean value  $S(r)$  on the sphere  $\{|z - z^0| = r\}$  is an increasing function of  $r$ .

◀ Again we assume that  $z^0 = 0$ . As we see from (8), it suffices to prove that the mean value of the subharmonic function  $u(\zeta) = \varphi(\omega\zeta)$  on the circle  $\{|\zeta| = r\}$  is increasing, i.e., that the quantity

$$s(r) = \frac{1}{2\pi} \int_0^{2\pi} u(re^{it}) dt$$

is increasing.

<sup>(23)</sup>Recall that a function  $h$  of class  $C^2$  is said to be harmonic if  $\sum_{\nu=1}^n \partial^2 h / \partial \zeta_\nu \partial \bar{\zeta}_\nu = 0$  at each point.

Let  $r_2 > r_1$  and let  $h(\zeta)$  be the best harmonic majorant of the function  $u$  in the disc  $\{|\zeta| < r_2\}$  (see Part I, Appendix, subsection 3). By the properties of subharmonic and harmonic functions we then have

$$s(r_1) \leq \frac{1}{2\pi} \int_0^{2\pi} h(r_1 e^{it}) dt = \frac{1}{2\pi} \int_0^{2\pi} h(r_2 e^{it}) dt = s(r_2). \blacktriangleright$$

We shall now prove that an arbitrary plurisubharmonic function can be approximated by functions of the same type, but which are  $C^\infty$ .

**THEOREM 2.** *For any function  $\varphi$  that is plurisubharmonic in a domain  $D \subset \mathbb{C}^n$  we can construct an increasing sequence of open sets  $G_\mu$  ( $\mu = 1, 2, \dots$ ),  $\bigcup_{\mu=1}^\infty G_\mu = D$ , and a decreasing sequence of functions  $\varphi_\mu \in C^\infty(G_\mu)$ , plurisubharmonic in  $G_\mu$ , converging to  $\varphi$  at each point  $z \in D$ :*

$$\varphi_\mu(z) \rightarrow \varphi(z), \quad \varphi_{\mu+1} \leq \varphi_\mu.$$

◀ If  $\varphi \equiv -\infty$ , then we can take as  $\varphi_\mu$  the sequence  $\varphi_\mu(z) \equiv -\mu$ . In the general case the sequence  $\varphi_\mu$  is constructed by means of averages. We take the function

$$K(z) = \begin{cases} ce^{-1/(1-|z|^2)}, & |z| < 1, \\ 0, & |z| \geq 1, \end{cases} \quad (10)$$

choosing the constant  $c$  so that the integral of  $K$  over the whole space  $\mathbb{C}^n$  is equal to 1 (actually the integral over the ball  $\{|z| < 1\}$ , since  $K = 0$  outside the ball). We use this function as an averaging kernel, setting

$$\varphi_\mu(z) = \int \varphi \left( z + \frac{w}{\mu} \right) K(w) dV, \quad (11)$$

where  $dV$  is the  $2n$ -dimensional volume element and the integral is taken over the whole of  $\mathbb{C}^n$  (actually over the unit ball). It is clear that every function  $\varphi_\mu$  is defined in the  $(1/\mu)$ -contraction of the domain  $D$ , i.e., in the open set

$$G_\mu = \{z \in D : \delta(z, \partial D) > 1/\mu\},$$

where  $\delta$  is the Euclidean distance. It is also clear that  $G_\mu \subset G_{\mu+1}$  for any  $\mu$  and that  $\bigcup_{\mu=1}^\infty G_\mu = D$ .

After making the change of variables  $z + \frac{w}{\mu} \rightarrow w$  the integral (11) takes the form

$$\varphi_\mu(z) = \mu^{2n} \int \varphi(w) K(\mu(w - z)) dV,$$

from which it is clear that  $\varphi_\mu \in C^\infty(G_\mu)$  (in fact, the integrand, and hence the integral, depends on  $z$  in a  $C^\infty$  manner). Using the criterion that is expressed by the inequality (5), it is easy to establish that the functions  $\varphi_\mu$  are plurisubharmonic: for all  $z \in G_\mu$ ,  $\omega \in \mathbb{C}^n$ , and all sufficiently small  $r$



we have

$$\begin{aligned} & \frac{1}{2\pi} \int_0^{2\pi} \varphi_\mu(z + \omega e^{it}) dt \\ &= \int K(w) \left\{ \frac{1}{2\pi} \int_0^{2\pi} \varphi \left( z + \frac{w}{\mu} + \omega e^{it} \right) dt \right\} dV \\ &\geq \int K(w) \varphi \left( z + \frac{w}{\mu} \right) dV = \varphi_\mu(z) \end{aligned}$$

(we used the plurisubharmonicity of  $\varphi$  and the nonnegativity of the kernel  $K$ ).

Replacing  $dV = d\sigma_r dr$ , where  $d\sigma_r$  is a surface element of the sphere  $\{|w| = r\}$ , and then making the change of variables  $z + \frac{w}{\mu} \rightarrow w$ , we transform (11) to the form

$$\begin{aligned} \varphi_\mu(z) &= \int_0^1 K(r) dr \int_{\{|w|=r\}} \varphi \left( z + \frac{w}{\mu} \right) d\sigma_r \\ &= \int_0^1 K(r) dr \mu^{2n-1} \int_{\{|w-z|=r/\mu\}} \varphi(w) d\sigma_{r/\mu} \quad (12) \\ &= \int_0^1 K(r) \mu^{2n-1} \sigma \left( \frac{r}{\mu} \right) S \left( \frac{r}{\mu} \right) dr = \int_0^1 K(r) \sigma(r) S \left( \frac{r}{\mu} \right) dr, \end{aligned}$$

where  $S(r/\mu)$  is the mean value of  $\varphi$  on the sphere  $\{|w - z| = r/\mu\}$ , and  $\mu^{2n-1} \sigma(r/\mu) = \sigma(r)$  is the area of the sphere of radius  $r$ .<sup>(24)</sup> Now on the basis of property 7° we can conclude that the functions  $\varphi_\mu$  decrease as  $\mu$  grows.

Since the function  $\varphi$  is plurisubharmonic, its mean value  $S(r/\mu) \geq \varphi(z)$ , and since

$$\int_0^1 K(r) \sigma(r) dr = \int K dV = 1,$$

it follows from (12) that  $\varphi_\mu(z) \geq \varphi(z)$  at any point  $z \in D$  for all  $\mu$  beginning with some  $\mu_0$ . On the other hand, since the function  $\varphi$  is semicontinuous, for any  $\varepsilon > 0$  we will have  $\varphi(w) - \varphi(z) < \varepsilon$  for all  $w$  sufficiently close to  $z$ , i.e.,  $S(r/\mu) \leq \varphi(z) + \varepsilon$  for all  $\mu \geq \mu_0$ ; for such  $\mu$  we obtain from (12) that  $\varphi_\mu(z) < \varphi(z) + \varepsilon$ . Thus, for all  $z \in D$  we have

$$\lim_{\mu \rightarrow \infty} \varphi_\mu(z) = \varphi(z). \quad \blacktriangleright$$

**REMARKS.** 1. The limit of a decreasing sequence of subharmonic functions is a subharmonic function (see Problem 10 of the Appendix to Part I), and this assertion carries over directly to plurisubharmonic functions. Therefore the converse to Theorem 2 holds.

2. In Theorem 2 the approximating functions can be assumed to be STRICTLY plurisubharmonic; for this it suffices to replace  $\varphi_\mu(z)$  by  $\varphi_\mu(z) + \frac{1}{\mu}|z|^2$ .

<sup>(24)</sup>We write  $K(r)$  instead of  $K(w)$ , since according to (10)  $K$  depends only on  $|w| = r$ .

**THEOREM 3.** *If the function  $\varphi$  is plurisubharmonic in a domain  $D \subset \mathbb{C}^n$ , and  $\psi: \varphi(D) \rightarrow \mathbb{R}$  is an increasing convex function of class  $C^2$ , then  $\psi \circ \varphi$  is plurisubharmonic in  $D$ .*

◀ First suppose  $\varphi \in C^2(D)$ . By property (b) of the Levi form (subsection 37)

$$H_z(\psi \circ \varphi, \omega) = \psi' \circ \varphi(z) H_z(\varphi, \omega) + \psi'' \circ \varphi(z) |\partial \varphi(\omega)|^2,$$

and since  $\psi', \psi'' \geq 0$ , the assertion is proved for this case.

In the general case we use Theorem 2 and its converse: we approximate  $\varphi$  by a sequence of smooth plurisubharmonic functions  $\varphi_\mu \searrow \varphi$ ; by what we just proved the functions  $\psi \circ \varphi_\mu$  are plurisubharmonic, and since  $\psi$  is an increasing continuous function, then  $\psi \circ \varphi_\mu \searrow \psi \circ \varphi$  and, hence,  $\psi \circ \varphi$  is plurisubharmonic. ▶

In the definition of a plurisubharmonic function we required that its restrictions to complex lines be subharmonic functions. This property admits the following stronger form:

**THEOREM 4.** *The restriction of a plurisubharmonic function  $\varphi$  in a domain  $D \subset \mathbb{C}^n$  to any  $m$ -dimensional holomorphic surface  $f: G \rightarrow \mathbb{C}^n$ ,  $G \subset \mathbb{C}^m$ , is also a plurisubharmonic function on the open set  $\Omega = \{\zeta \in G: f(\zeta) \in D\}$ .*

◀ To simplify the formal computations we restrict ourselves to the case  $m = 1$ , i.e., we shall show that the restriction of  $\varphi$  to the holomorphic curve  $z = f(\zeta)$  is a subharmonic function.

First suppose  $\varphi \in C^2(D)$ . Then for  $u = \varphi \circ f$  by the chain rule at any point  $\zeta \in G$  we have

$$\frac{\partial^2 u}{\partial \zeta \partial \bar{\zeta}} = \sum_{\mu, \nu=1}^n \frac{\partial^2 \varphi}{\partial z_\mu \partial \bar{z}_\nu} \frac{\partial f_\mu}{\partial \zeta} \overline{\left( \frac{\partial f_\nu}{\partial \zeta} \right)}.$$

Since  $\varphi$  is plurisubharmonic, then by Theorem 1 the form in the right-hand side is nonnegative, and this means that  $u(\zeta)$  is a subharmonic function.

The general case reduces to this one using Theorem 2 and the remarks following it. ▶

**COROLLARY.** *The maximum principle holds for the restriction to a holomorphic surface  $S$  of a function  $\varphi$  that is plurisubharmonic in a neighborhood of  $S$ .*

In particular, for a bounded holomorphic surface  $S$  (see subsection 36) this principle can be formulated as:

$$\|\varphi\|_S = \|\varphi\|_{\partial S}. \quad (13)$$

We also state without proof<sup>(25)</sup> a theorem on the extension of plurisubharmonic functions that is analogous to Riemann's extension theorem for holomorphic functions (Theorem 3 of subsection 32):

<sup>(25)</sup>H. Grauert and R. Remmert, *Plurisubharmonische Funktionen in komplexen Räumen*, Math. Z. 65 (1956), no. 2, 175–194.

**THEOREM (Grauert-Remmert).** *Any function that is plurisubharmonic in a domain  $D \subset \mathbb{C}^n$  everywhere except for an analytic set and is bounded can be extended to a function that is plurisubharmonic in  $D$ .*

**39. Pseudoconvex domains.** Here we consider domains that are pseudoconvex at each of their boundary points, and thus we introduce a global aspect of the concept of pseudoconvexity. One of the characteristics of convex domains in  $\mathbb{R}^n$  is that they can be exhausted by the sets of smaller values of convex functions, i.e., that in them there exists a convex function which grows unboundedly in the approximation to the boundary. We are led to the concept of global pseudoconvexity if we replace the real structure by a complex structure.

**DEFINITION 1.** A domain  $D \subset \mathbb{C}^n$  is said to be (globally) pseudoconvex if in  $D$  there exists a plurisubharmonic function  $u$  such that  $u(z) \rightarrow +\infty$  as  $z \rightarrow \partial D$ , or, in other words, such that

$$\{z \in D : u(z) < \alpha\} \subset\subset D \quad \text{for all } \alpha \in \mathbb{R}. \tag{1}$$

We note that on the plane  $\mathbb{C}$  any domain is pseudoconvex. In fact, for  $\overline{\mathbb{C}} \setminus \{\zeta\}$  we can take as the function  $\varphi$  from the definition  $u(z) = 1/|z - \zeta|$  if  $\zeta \neq \infty$  and  $u(z) = |z|$  if  $\zeta = \infty$ . In the general case the conditions of the definition are satisfied by the function

$$u(z) = |z| + \sup_{\zeta \in \partial D} \frac{1}{|z - \zeta|} = |z| + \frac{1}{\delta(z, \partial D)}$$

( $\delta$  denotes the Euclidean distance), since it is continuous<sup>(26)</sup> and is the upper envelope of a family of subharmonic functions.

For  $n > 1$  the concept acquires a meaning: it distinguishes an important class of domains which, as we shall now prove, coincides with the class of domains that are pseudoconvex in the sense of subsection 37 at all boundary points.

\* Prove that the domain  $D = \{z \in \mathbb{C}^n : r < |z| < R\}$  for  $n > 1$  is not pseudoconvex at all boundary points. \*

The *Hartogs radius* of a domain  $D \subset \mathbb{C}^n$  at a point  $a \in D$  is the radius  $R(a)$  of the largest disc with center  $a$  lying in the intersection of  $D$  with the complex line  $l = \{z = 'a, z_n = \zeta\}$ , parallel to the  $z_n$ -axis:

$$R(a) = \delta(a, \partial D \cap l). \tag{2}$$

**LEMMA.** *If the domain  $D \subset \mathbb{C}^n$  is pseudoconvex at all boundary points, then the function  $u(z) = -\ln R(z)$ , where  $R(z)$  is the Hartogs radius of  $D$  at the point  $z$ , is plurisubharmonic in  $D$ .*

◀ For an arbitrary domain  $D \subset \mathbb{C}^n$  the Hartogs radius  $R$  is lower semicontinuous and the function  $u = -\ln R(z)$  is upper semicontinuous

<sup>(26)</sup>By the triangle inequality the function  $\delta(z, \partial D)$  satisfies a Lipschitz condition and  $\delta(z, \partial D) \neq 0$  for  $z \in D$ .

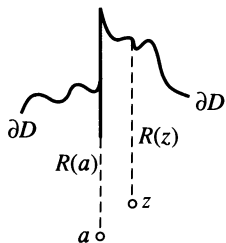

FIGURE 41

in  $D$ . In fact, for any point  $a \in D$  it is obvious (see Figure 41) that  $\lim_{z \rightarrow a} R(z) \geq R(a)$ . It remains to prove that under the hypotheses of the lemma the restriction of the function  $u = -\ln R$  to an arbitrary complex line

$$l_\omega = \{z \in \mathbb{C}^n : z = l(\zeta) = a + \omega\zeta\}, \tag{3}$$

where  $a \in D$ ,  $\omega \in \mathbb{C}^n$ , is a subharmonic function in a neighborhood of the point  $\zeta = 0$ . If  $'\omega = '0$ , i.e.,  $l_\omega$  is parallel to the  $z_n$ -axis, then we have the situation of the case of the plane:  $R|_{l_\omega} = \inf_{z' \in \partial D \cap l_\omega} |z_n - z'_n|$ , and hence, the function

$$u|_{l_\omega} = -\ln R|_{l_\omega} = \sup_{z' \in \partial D \cap l_\omega} \{-\ln |z_n - z'_n|\}$$

is subharmonic as an upper semicontinuous upper envelope of subharmonic functions.

In the case  $'\omega \neq '0$  we carry out the proof by deriving a contradiction. If the function

$$u|_{l_\omega} = -\ln R \circ l(\zeta) = v(\zeta) \tag{4}$$

is not subharmonic in a neighborhood of  $\zeta = 0$ , then there exist a disc  $U = \{|\zeta| < r\}$  and a function  $h$ , continuous in  $\bar{U}$  and harmonic in  $U$ , such that  $v(\zeta) \leq h(\zeta)$  on  $\partial U$ , but at some point  $\zeta_0 \in U$  we have

$$h(\zeta_0) - v(\zeta_0) = \inf_{\bar{U}} \{h(\zeta) - v(\zeta)\} = -\varepsilon < 0$$

(we have used the fact that the lower semicontinuous function  $h - v$  attains its infimum on a compact set). We denote by  $g(\zeta) = -h(\zeta) - \varepsilon$  a function that is harmonic in  $U$  and continuous in  $\bar{U}$ ; we have

$$\begin{aligned} g(\zeta) &< -v(\zeta) && \text{on } \partial U, \\ g(\zeta) &\leq -v(\zeta) && \text{in } \bar{U}, \\ g(\zeta_0) &= -v(\zeta_0). \end{aligned} \tag{5}$$

Now suppose in (3) the function  $l(\zeta) = ('l(\zeta), \lambda(\zeta))$ , so that  $'l(\zeta) = 'a + '\omega\zeta$  and  $\lambda(\zeta) = a_n + \omega_n\zeta$ . By the definition of the Hartogs radius there exists a point  $b = ('b, b_n) \in \partial D$  such that  $'b = 'l(\zeta_0)$  and  $|b_n - \lambda(\zeta_0)| = R \circ l(\zeta_0)$ . We construct a holomorphic function  $G = g + ig_*$  in  $U$  so that

$G(\zeta_0)$  will coincide with some value of  $\ln(b_n - \lambda(\zeta_0))$ ; this can be done since by (4) and (5) we have  $\ln|b_n - \lambda(\zeta_0)| = -v(\zeta_0) = g(\zeta_0)$ .

We now consider the family of holomorphic discs:

$$S_t = \{z \in \mathbb{C}^n : 'z = 'l(\zeta), z_n = \lambda(\zeta) + te^{G(\zeta)}, \zeta \in \bar{U}\}. \tag{6}$$

For any point  $z \in S_t, 0 \leq t \leq 1$ , we have  $'z = 'l(\zeta)$  and in view of the second inequality of (5)

$$|z_n - \lambda(\zeta)| = te^{g(\zeta)} \leq te^{-u(\zeta)} = tR \circ l(\zeta).$$

By the definition of Hartogs radius it follows from this that for  $t < 1$  all the  $S_t \subset D$ . In view of the first inequality of (5) we will obtain analogously that  $\partial S_t \subset D$  for all  $t, 0 \leq t \leq 1$ . The discs  $S_t \rightarrow S_1$  as  $t \rightarrow 1$ ; but  $S_1$  contains the point  $b \in \partial D$ , since for  $\zeta = \zeta_0$  we have  $'z = 'l(\zeta_0) = 'b$  and  $z_n = \lambda(\zeta_0) + e^{G(\zeta_0)} = b_n$  (we have  $\ln G(\zeta_0) = b_0 - \lambda(\zeta_0)$ ). We have arrived at a contradiction with the fact that by hypothesis the domain  $D$  is locally pseudoconvex at  $b$ . ►

REMARK. In subsection 8 we introduced the domain of convergence of the Hartogs series

$$f(z) = \sum_{\mu=0}^{\infty} g_{\mu}('z)z_n^{\mu} \tag{7}$$

as the interior  $D = \{('z, z_n) : 'z \in 'D, |z_n| < R('z)\}$  of the set of convergence of this series (we assumed that the  $g_{\mu}$  are holomorphic in  $'D$ ). The quantity  $R('z)$  is obviously the Hartogs radius of the domain  $D$ . Repeating the proof of the lemma in the case  $'\omega \neq '0$  with slight changes,<sup>(27)</sup> we can prove that the function  $-\ln R('z)$  is plurisubharmonic in  $'D$ .

THEOREM 1. *If a domain  $D \subset \mathbb{C}^n$  is locally pseudoconvex at each of its boundary points, then it is globally pseudoconvex.*

◀ The function  $u(z) = -\ln \delta(z, \partial D)$  is continuous in the domain  $D$  (except for the trivial case  $D = \mathbb{C}^n$ ) and tends to  $+\infty$  as  $z \rightarrow \partial D$ . It remains to show that it is plurisubharmonic in  $D$ .

We denote by  $l_{\omega}$  the complex line  $\zeta \rightarrow z + \omega\zeta$  passing through the point  $z \in D$  in the direction of the vector  $\omega$ , and let  $R_{\omega}(z) = \delta(z, \partial D \cap l_{\omega})$ .

<sup>(27)</sup>These changes are the following: (1) we need to take the restriction of  $-\ln R$  to the line  $'z = l(\zeta)$ ; (2) after setting  $'b = l(\zeta_0)$  we need to choose  $b_n$  so that  $|b_n| = R('b)$  and the point  $b = ('b, b_n)$  will be singular for  $f$ —this can be done since on each circle  $\{ 'z, |z_n| = r('z)\}$ , where  $r('z)$  is the radius of convergence of the series (7) for fixed  $'z$ , there is at least one singular point of  $f$  and  $R('b) = \lim_{z \rightarrow 'b} r('z)$  (see the first footnote in subsection 8) and hence, on the circle  $\{ 'b, |b_n| = R('b)\}$  there is a limit point of singular points; (3) the function  $G = g + ig_*$  must be chosen so that  $G(\zeta_0) = \ln b_n$  (this can be done since  $g(\zeta_0) = \ln|b_n|$ ) and instead of (6) we take the family of curves  $S_t = \{ 'z = l(\zeta), z_n = te^{G(\zeta)}, \zeta \in \bar{U}\}$ . The assertion is proved by a contradiction, which is that by the continuity principle  $f$  extends to the point  $b$  and it is singular.

Obviously, for all  $z \in D$ , we have

$$\delta(z, \partial D) = \inf_{\omega} R_{\omega}(z),$$

where the infimum is taken over all vectors  $\omega \in \mathbb{C}^n$ ,  $|\omega| = 1$ .

By applying a complex rotation  $z \rightarrow Cz$ , where  $C = (c_{\mu\nu})$  is a unitary  $n \times n$  matrix, we can change the direction of  $\omega$  to the direction of the  $z_n$ -axis, so that  $R_{\omega}$  becomes the Hartogs radius of the domain  $D$ . Since such a rotation preserves both Euclidean distances and pseudoconvexity (local and global), then by the Lemma we can assert that the function  $-\ln R_{\omega}(z)$  is plurisubharmonic in  $D$ . But then

$$u(z) = -\ln \delta(z, \partial D) = \sup_{\omega} (-\ln R_{\omega}(z)),$$

since it is a continuous upper envelope of plurisubharmonic functions, is also plurisubharmonic in  $D$ . ►

**THEOREM 2.** *Any pseudoconvex domain  $D \subset \mathbb{C}^n$  is pseudoconvex at each boundary point.*

◄ Suppose to the contrary that  $D$  is not pseudoconvex at some point  $a \in \partial D$ . Then there is a sequence of holomorphic discs  $S_{\nu}$  such that  $S_{\nu} \rightarrow S$  and  $\partial S_{\nu} \rightarrow \partial S$ , where  $\bar{S}_{\nu}, \partial S \subset D$  and  $S$  contains the point  $a$ . Since  $D$  is pseudoconvex there exists a plurisubharmonic function  $u(z)$  in  $D$  that tends to  $+\infty$  as  $z \rightarrow \partial D$ . By the maximum principle for plurisubharmonic functions (the corollary of Theorem 4 of the preceding subsection)

$$\sup_{S_{\nu}} u \leq \sup_{\partial S_{\nu}} u < c < \infty, \quad (8)$$

where the constant  $c$  does not depend on  $\nu$  since the union of the  $\partial S_{\nu}$  is compactly contained in  $D$ . But, on the other hand, there exists a sequence of points  $z^{\nu} \in S_{\nu}$  that converges to the point  $a \in \partial D$ , and also  $u(z^{\nu}) \rightarrow \infty$ , which contradicts (8). ►

Theorems 1 and 2 taken together show that the concept of global pseudoconvexity of a domain is actually equivalent to the domain's being pseudoconvex at each of its boundary points.

**COROLLARY.** *A domain  $D \subset \mathbb{C}^n$  is pseudoconvex if and only if the function  $-\ln \delta(z, \partial D)$  is plurisubharmonic in  $D$ .*

◄ The sufficiency of the condition that the function  $-\ln \delta(z, \partial D)$  be plurisubharmonic follows from the definition of pseudoconvexity. This condition is also necessary: suppose  $D$  is pseudoconvex; by Theorem 2 it is pseudoconvex at every boundary point, and then from the proof of Theorem 1 we see that the function  $-\ln \delta(z, \partial D)$  is plurisubharmonic in  $D$ . ►

For domains with a  $C^2$  boundary global pseudoconvexity can be described in terms of a defining function similar to the way it was done in subsection 37 for local pseudoconvexity, instead of in terms of an exhaustion function

(as in Definition 1). A function  $\varphi$  is called a *global defining function* for a domain  $D \subset \mathbb{C}^n$  if it is of class  $C^2$  in some neighborhood  $\Omega$  of the whole boundary  $\partial D$ , and in this neighborhood  $D \cap \Omega = \{z \in \Omega : \varphi(z) < 0\}$  and the gradient  $\nabla_z \varphi \neq 0$  for all  $z \in \partial D$  (cf. subsection 37).

DEFINITION 2. A domain  $D \subset \mathbb{C}^n$  with a  $C^2$  boundary is said to be (*globally*) *pseudoconvex* if it possesses a global defining function  $\varphi$  for which the Levi form  $H_z(\varphi, \omega) \geq 0$  for all  $z \in \partial D$  and  $\omega \in T_z^c(\partial D)$ , and *strictly pseudoconvex* if it is bounded and  $H_z(\varphi, \omega) > 0$  for all  $z \in \partial D$  and  $\omega \in T_z^c(\partial D)$ ,  $\omega \neq 0$ .

As in subsection 37, we can prove that these requirements do not depend on the choice of a defining function, so that if they are valid for any defining function, they are valid for all. By the implicit function theorem we can conclude that a defining function for domains with a  $C^2$  boundary can be chosen in the form

$$\varphi(z) = \begin{cases} -\delta(z, \partial D) & \text{for } z \in \Omega \cap D, \\ \delta(z, \partial D) & \text{for } z \in \Omega \setminus \overline{D}, \end{cases} \quad (9)$$

where  $\delta(z, \partial D)$  is the Euclidean distance of  $z$  from  $\partial D$  if the strip  $\Omega$  is sufficiently narrow. It is also clear that a domain is (strictly) pseudoconvex if and only if it is (strictly) pseudoconvex at each of its boundary points in the sense of subsection 37.

We shall indicate the connection between global pseudoconvexity and pluri-subharmonicity. For strictly pseudoconvex domains it is particularly simple.

THEOREM 3. *A domain  $D \subset \mathbb{C}^n$  is strictly pseudoconvex if and only if it has a strictly plurisubharmonic defining function.*

◀ The sufficiency of the condition is obvious and the necessity is proved in essentially the same way as Theorem 1 of subsection 37. Let  $\varphi$  be some defining function of the domain  $D$ , for example, (9); if the strip  $\Omega$  is sufficiently narrow, then the function  $\psi = \varphi + k\varphi^2$  for any constant  $k \geq 0$  will also be a defining function, and for all  $z \in \partial D$  we have

$$H_z(\psi, \omega) = H_z(\varphi, \omega) + 2k|\partial\varphi(\omega)|^2 \quad (10)$$

(cf. (13) of subsection 37). It suffices to prove that  $H_z(\psi, \omega)$  is positive on the compact set<sup>(28)</sup>  $E = \{(z, \omega) : z \in \partial D, \omega \in \mathbb{C}^n, |\omega| = 1\}$ . Let  $E_0 = \{(z, \omega) \in E : H_z(\varphi, \omega) \leq 0\}$ ; if  $E_0$  is empty, set  $k = 0$ ; if it is not empty, we choose a constant  $M \geq 0$  such that  $H_z(\varphi, \omega) \geq -M$  for all  $(z, \omega) \in E_0$ .

By the definition of strict pseudoconvexity for  $\partial\varphi(\omega) = 0$ , i.e., on  $T_z^c(\partial D)$ , the form  $H_z(\varphi, \omega) > 0$  for all  $z \in \partial D$  and  $\omega \neq 0$ ; hence  $\partial\varphi(\omega) \neq 0$  on  $E_0$ , and by compactness there is an  $m > 0$  such that

<sup>(28)</sup>We have learned above that a strictly pseudoconvex domain  $D$  is bounded, and hence,  $\partial D$  is compact.

$|\partial\varphi(\omega)| \geq m$  on  $E_0$ . Choosing  $k > M/(2m^2)$ , we obtain from (10) that on  $E_0$  the form  $H_z(\psi, \omega) \geq -M + 2km^2 > 0$ , and on  $E \setminus E_0$  its positivity is obvious. From continuity considerations it is clear that if  $\Omega$  is sufficiently narrow, then  $H_z(\psi, \omega) > 0$  for  $\omega \neq 0$  not only on  $\partial D$ , but also for all  $z \in \Omega$ , and this means that the function  $\psi$  is strictly plurisubharmonic. ►

We note that the function  $\psi$  can be extended inside the strip  $\Omega$  to a negative strictly plurisubharmonic function (for example, by setting it equal to  $-\varepsilon$  inside the level set  $\psi(z) = -\varepsilon$  and then smoothing it; a detailed proof of this, however, is rather complicated). Therefore strictly pseudoconvex domains can be defined as the sets of negative values of functions that are strictly plurisubharmonic in a neighborhood of the closure of the domain.

For simply pseudoconvex domains the situation is more complicated. In the general case they cannot be represented as sets of negative values of subharmonic functions.

\* Prove this for the image of  $\mathbb{C}^2$  under the Fatou mapping from subsection 11. \*

Nevertheless K. DIEDERICH and J. FORNÆSS recently proved<sup>(29)</sup> that for any bounded pseudoconvex domain  $D \subset \mathbb{C}^n$  with a  $C^2$  boundary in a neighborhood of  $\bar{D}$  there is a defining function  $\varphi$  of class  $C^2$  such that the function  $\psi = -(-\varphi)^\eta$  for sufficiently small  $\eta > 0$  is plurisubharmonic (even strictly) in  $D$ . We note, however, that the function  $\varphi$  is not obliged to be plurisubharmonic (the function  $\varphi = -(-\psi)^{1/\eta}$  increases but is not convex; see Theorem 3 of subsection 38), nor  $\psi$  a defining function (it is not defined outside  $\bar{D}$ , and on  $\partial D$  its gradient may not exist).

To conclude this section we give a summary of conditions that characterize domains of holomorphy in  $\mathbb{C}^n$ .

**THEOREM 4.** *The following five conditions are equivalent:*

(I)  $D$  is a domain of holomorphy (i.e., there exists a function  $f \in \mathcal{O}(D)$  that cannot be extended holomorphically into a larger domain; see subsection 33);

(II)  $D$  is holomorphically convex (i.e., for any set  $K \subset\subset D$  the holomorphically convex hull  $\hat{K}_\mathcal{O} = \{z \in D : |f(z)| \leq \|f\|_K \text{ for all } f \in \mathcal{O}(D)\} \subset\subset D$ ; see subsection 34);

(III)  $D$  cannot be extended holomorphically to each boundary point (i.e., for any point  $a \in \partial D$  there exist a neighborhood  $U$  and a function  $f \in \mathcal{O}(D \cap U)$  that cannot be extended holomorphically to the point  $a$ ; see subsection 37)  $D$  is locally convex at each boundary point (i.e., at no point  $a \in \partial D$  can it be tangent from the interior by a family of holomorphic discs; see subsection 37);

(IV)  $D$  is locally pseudoconvex (i.e., at no point  $a \in \partial D$  can it be tangent from the interior by a family of holomorphic discs; see subsection 37);

<sup>(29)</sup>See K. Diederich and J. Fornæss, *Pseudoconvex domains: bounded strictly plurisubharmonic exhaustion functions*, *Invent. Math.* **39** (1977), 129–141.



(V)  $D$  is *pseudoconvex* (i.e., there exists a plurisubharmonic function in  $D$  that tends to  $+\infty$  as  $\partial D$  is approached; see subsection 39).

◀ Above we proved the following implications:

$$I \Leftrightarrow II$$

↓

$$III \Rightarrow IV \Leftrightarrow V$$

(the equivalence  $I \Leftrightarrow II$  forms the content of Theorems 1 and 2 subsection 34,  $IV \Leftrightarrow V$  that of Theorems 1 and 2 of the current subsection,  $III \Rightarrow IV$  is the continuity principle of subsection 36, and  $I \Rightarrow III$  is trivial). In the following chapter we shall prove (subsection 45) that every pseudoconvex domain in  $\mathbb{C}^n$  is a domain of holomorphy, i.e., we shall prove the implication  $V \Rightarrow I$ . This closes our chain of equivalences. ▶

### §14. Envelopes of holomorphy

If  $D$  is not a domain of holomorphy, then any function  $f \in \mathcal{O}(D)$  extends holomorphically into a larger domain. There arises the question of finding the so-called envelope of holomorphy of the domain  $D$ ; this is the smallest domain to which all functions from  $\mathcal{O}(D)$  extend. This question is important both from the theoretical point of view and from the point of view of applications, for example, in quantum physics.<sup>(30)</sup>

**40. One-sheeted envelopes.** In subsection 33 we gave an example of a domain from which each holomorphic function extends to a larger domain, where some functions turn out to be multiple-valued under extension, so that the envelope of holomorphy of this domain is a Riemann (multiple-sheeted) domain. We shall consider such domains in the following subsections, but here we restrict ourselves to cases in which such phenomena do not arise. However, we shall formulate the definition so that it can also be generalized to the multiple-sheeted case.

**DEFINITION.** A domain  $\tilde{D} \subset \mathbb{C}^n$  is called a (one-sheeted) *envelope of holomorphy of a domain*  $D \subset \mathbb{C}^n$  if: (1)  $D \subset \tilde{D}$  and any function  $f \in \mathcal{O}(D)$  extends to a function that is holomorphic in  $\tilde{D}$ ; (2) for any point  $z^0 \in \tilde{D}$  there exists a function  $f_0 \in \mathcal{O}(\tilde{D})$  whose restriction to the ball  $B(z^0, r)$ , where  $r = \delta(z^0, \partial \tilde{D})$ , does not extend to any ball  $B(z^0, R)$ , where  $R > r$ .<sup>(31)</sup>

From what was said above it follows that one-sheeted envelopes of holomorphy do not exist for all domains in  $\mathbb{C}^n$ . In this subsection we consider the basic properties of one-sheeted envelopes of holomorphy, and also questions of the construction of envelopes for domains of the simplest classes.

<sup>(30)</sup>See N. N. BOGOLYUBOV AND D. V. SHIRKOV, *Introduction to quantum field theory*, 3rd revised ed., "Nauka", Moscow, 1976; English transl., Wiley, New York, 1980.

<sup>(31)</sup>Instead of the ball we can take the polydisc  $U(z^0, r)$ , where  $r = \rho(z^0, \partial D)$ .

First of all we note that envelopes of holomorphy are holomorphic extensions of domains in the sense of subsection 33. Therefore by Theorem 1 in subsection 33 any function that is holomorphic in a domain  $D$  takes in the envelope  $\tilde{D}$  of  $D$  only those values that it took in the original domain  $D$ . In particular, the envelope of holomorphy of a bounded domain is always a bounded domain (this assertion is obtained from the preceding one if we apply it to the coordinates  $z_\nu$ ,  $\nu = 1, \dots, n$ ).

Furthermore, the maximality condition (2) in the definition of an envelope of holomorphy can be strengthened in an essential way. This condition is a condition of LOCAL nonextendability of some function belonging to  $\mathcal{O}(\tilde{D})$ , but one can assert that there also exists a GLOBALLY nonextendable function in  $\mathcal{O}(\tilde{D})$ . In other words, we have

**THEOREM 1.** *The one-sheeted envelope of holomorphy  $\tilde{D}$  of a domain  $D \subset \mathbb{C}^n$  is a domain of holomorphy.*

◀ On the basis of the results of subsection 34 it suffices to prove that  $\tilde{D}$  is holomorphically convex. Let  $K \subset\subset \tilde{D}$  and let  $\rho(K, \partial\tilde{D}) = r$ ; by the lemma on simultaneous extension (subsection 34) any function  $f \in \mathcal{O}(\tilde{D})$  extends holomorphically into the polydisc  $U(z, r)$  with center at any point  $z \in \hat{K}_{\mathcal{O}(\tilde{D})}$ . From condition (2) in the definition of an envelope of holomorphy it follows from this that  $\rho(z, \partial\tilde{D}) \geq r$ , and hence,  $\rho(\hat{K}_{\mathcal{O}(\tilde{D})}, \partial\tilde{D}) \geq r$ . But since this distance cannot be greater than  $r$ , then  $\rho(\hat{K}_{\mathcal{O}(\tilde{D})}, \partial\tilde{D}) = \rho(K, \partial\tilde{D})$  and  $\tilde{D}$  is holomorphically convex. ▶

**COROLLARY.** *If the domain  $D \subset \mathbb{C}^n$  has a one-sheeted envelope of holomorphy  $\tilde{D}$ , then the latter is the smallest domain of holomorphy containing  $D$  (i.e., the intersection of all domains of holomorphy containing  $D$ ).*

◀ If  $G$  is a domain of holomorphy containing  $D$ , then  $G \supset \tilde{D}$  (since  $\mathcal{O}(G) \subset \mathcal{O}(D)$ , then any  $f \in \mathcal{O}(G)$  extends holomorphically to  $\tilde{D}$ ). But by Theorem 1  $\tilde{D}$  is a domain of holomorphy, and hence,  $\tilde{D}$  is the smallest domain of holomorphy containing  $D$ . ▶

**REMARK.** At first glance it may appear that similarly to Theorem 1 the local nonextendability of a domain implies its global nonextendability, i.e., the implication (III)  $\Rightarrow$  (I) in Theorem 4 of the preceding subsection. However condition (III) considers functions that are holomorphic not in the whole domain, but only in a neighborhood of a boundary point, and therefore the proof of Theorem 1 here does not go through. As we already said, the implication (III)  $\Rightarrow$  (I) is the content of the very delicate theorem of Oka.

For the proof of the next theorem we need a

**LEMMA.** *If  $D$  is a domain of holomorphy, then any connected component  $\Delta$  of its  $r$ -contraction  $D_r = \{z \in D : \rho(z, \partial D) > r\}$  is also a domain of holomorphy.*

◀ Let  $K \subset\subset \Delta$  and  $\rho(K, \partial\Delta) = \rho$ ; for arbitrary points  $z \in K$  and

$\zeta \in \partial D$  on the segment  $[z, \zeta]$  there is a point  $z' \in \partial\Delta$  such that

$$\rho(z, \zeta) = \rho(z, z') + \rho(z', \zeta) \geq \rho + r.$$

Therefore  $\rho(K, \partial D) \geq \rho + r$ , and since  $D$  is a domain of holomorphy, then by Theorem 3 of subsection 34 we also have

$$\rho(\widehat{K}_{\mathcal{O}(D)}, \partial D) \geq \rho + r. \tag{1}$$

We need to prove that  $\rho(\widehat{K}_{\mathcal{O}(\Delta)}, \partial\Delta) \geq \rho$ , i.e., that  $\rho(z^0, z') \geq \rho$  for arbitrary points  $z^0 \in \widehat{K}_{\mathcal{O}(\Delta)}$  and  $z' \in \partial\Delta$ . But since  $\Delta \subset D$ , then  $\widehat{K}_{\mathcal{O}(\Delta)} \subset \widehat{K}_{\mathcal{O}(D)}$ , hence  $z^0 \in \widehat{K}_{\mathcal{O}(D)}$ , and, according to (1),  $\rho + r \leq \rho(z^0, \partial D) \leq \rho(z^0, z') + \rho(z', \partial D) = \rho(z^0, z') + r$  (we have  $\rho(z', \partial D) = r$  since  $z' \in \partial\Delta$ ). From this it follows that  $\rho(z^0, z') \geq \rho$ . ►

**THEOREM 2.** *If  $D \subset G$  and these domains have one-sheeted envelopes  $\widetilde{D}$  and  $\widetilde{G}$ , respectively, then  $\widetilde{D} \subset \widetilde{G}$  and*

$$\rho(\partial\widetilde{D}, \partial\widetilde{G}) \geq \rho(\partial D, \partial G). \tag{2}$$

◀ Since  $\mathcal{O}(G) \subset \mathcal{O}(D)$ , then any function  $f \in \mathcal{O}(G)$  extends holomorphically into  $\widetilde{D}$ , and hence,  $\widetilde{D} \subset \widetilde{G}$ . Suppose  $\rho(\partial D, \partial G) = r > 0$  (for  $r = 0$  the theorem is trivial); then  $D \subset G_r \subset (\widetilde{G})_r$ . Obviously  $D$  belongs to some connected component of the set  $(\widetilde{G})_r$ , which by the lemma that we just proved is a domain of holomorphy. But then  $\widetilde{D}$  also belongs to this component, and hence, to the set  $(\widetilde{G})_r$ , as well; therefore  $\rho(\partial\widetilde{D}, \partial\widetilde{G}) \geq r$ . ►

**COROLLARY.** *If  $D$  is a bounded domain having a one-sheeted envelope of holomorphy  $\widetilde{D}$ , then the intersection  $\partial D \cap \partial\widetilde{D}$  is nonempty.*

◀ We apply Theorem 2 to the domains  $D$  and  $G = \widetilde{D}$ :

$$\rho(\partial D, \partial\widetilde{D}) \leq \rho(\partial\widetilde{D}, \partial\widetilde{D}) = 0$$

(we have used the fact that the envelope of holomorphy of a domain of holomorphy coincides with the latter). Since  $\partial D$  is compact (since  $D$  is bounded), then it follows from the equality  $\rho(\partial D, \partial\widetilde{D}) = 0$  that the sets  $\partial D$  and  $\partial\widetilde{D}$  intersect. ►

We proceed to describe the envelopes of holomorphy of the simplest classes of domains.

1. **TUBE DOMAINS.** Recall that a tube domain with base  $B \subset \mathbb{R}^n$  is a domain  $T = B \times \mathbb{R}^n(y)$ , i.e.,  $T = \{z = x + iy \in \mathbb{C}^n : x \in B\}$  (see subsection 2).

**THEOREM 3.** *The envelope of holomorphy of a tube domain  $T$  is its convex hull  $\widehat{T}$ .*

◀ Obviously,  $\widehat{T} = \widehat{B} \times \mathbb{R}^n(y)$ , where  $\widehat{B}$  is the convex hull of the base  $B$  in the space  $\mathbb{R}^n(x)$ . We shall show that any function  $f \in \mathcal{O}(T)$  extends

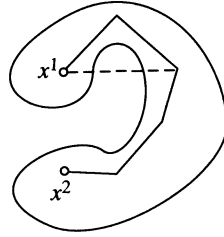

FIGURE 42

holomorphically to  $\hat{T}$ . The domain  $\hat{B}$  is the set of points of the segments  $[x^1, x^2]$ , where  $x^1, x^2 \in B$ . If  $x^1$  and  $x^2$  can be joined in  $B$  by the two-piece polygonal line  $[x^1, x^0] \cup [x^0, x^2]$ , then the extendability of  $f$  into a neighborhood of the set  $[x^1, x^2] \times \mathbb{R}^n(y)$  follows immediately from the prism lemma (subsection 36).

In the general case the points  $x^1, x^2 \in B$  can be joined in  $B$  by a finite-piece polygonal line (Figure 42). Using the same lemma as before by induction on the number of pieces we shall again prove that  $f$  extends holomorphically into a neighborhood of the set  $[x^1, x^2] \times \mathbb{R}^n(y)$ . The same lemma shows that the function  $f$  under the described extension remains single-valued. In fact, let  $x$  be the intersection point of the two segments  $[x^1, x^2]$  and  $[\tilde{x}^1, \tilde{x}^2]$  with ends in  $B$ , and in a neighborhood of the point  $z = x + iy$  we have obtained two values  $f$  and  $\tilde{f}$ . Consider the prism  $[x^1, x, \tilde{x}^1] \times \mathbb{R}^n(y)$ ; by the above-cited lemma the functions  $f$  and  $\tilde{f}$  are holomorphic in it, and since they coincide in a neighborhood of the points  $x^1 + iy$  and  $\tilde{x}^1 + iy$ , then by the uniqueness theorem they coincide in the whole prism.

Thus, any function  $f \in \mathcal{O}(T)$  extends holomorphically to  $\hat{T}$ . But  $\hat{T}$  is a convex domain and therefore is a domain of holomorphy (subsection 33). Consequently,  $\hat{T}$  is the envelope of holomorphy of the domain  $T$ .  $\blacktriangleright$

2. REINHARDT DOMAINS. In subsection 7 we proved that any function  $f$  that is holomorphic in a complete Reinhardt domain<sup>(32)</sup>  $D$  with center at a point  $a$  extends holomorphically to the logarithmically convex hull  $\hat{D}_L$  of this domain. This extension is realized via the Taylor expansion of  $f$ :

$$f(z) = \sum_{|k|=0}^{\infty} c_k (z - a)^k, \quad (3)$$

whose domain of convergence is a logarithmically convex domain (Theorem 3 of subsection 7).

**THEOREM 4.** *The envelope of holomorphy of a complete Reinhardt domain  $D$  is its logarithmically convex hull  $\hat{D}_L$ .*

◀ Since any function  $f \in \mathcal{O}(D)$  extends holomorphically to  $\hat{D}_L$  it only

<sup>(32)</sup>For the definition of a complete Reinhardt domain see subsection 2.

remains to prove that  $\widehat{D}_L$  is a domain of holomorphy. But it is not difficult to see that  $\widehat{D}_L$  is convex relative to the class of monomials  $z^k = z_1^{k_1} \cdots z_n^{k_n}$ , where the  $k_\nu$  are nonnegative integers. In fact, the logarithmic convexity of a domain means the geometric convexity of its image under the mapping  $\lambda: z \rightarrow (\ln|z_1|, \dots, \ln|z_n|)$ ; see subsection 7. Under this mapping the monomials become linear functions  $k_1 \ln|z_1| + \cdots + k_n \ln|z_n|$ , and it follows from the geometric convexity of  $\lambda(\widehat{D}_L)$  that  $\widehat{D}_L$  is convex relative to monomials. Since for  $k_\nu \geq 0$  the monomials  $z^k \in \mathcal{O}(\widehat{D}_L)$ , then by Theorem 1 of subsection 34 (see the remark following it),  $\widehat{D}_L$  is a domain of holomorphy. ►

**COROLLARY.** *Any logarithmically convex complete Reinhardt domain is the domain of convergence of some power series.*

◄ By the previous theorem such a domain  $D$  is a domain of holomorphy, and hence, there exists a function  $f \in \mathcal{O}(D)$  that cannot be extended outside of  $D$ . The Taylor expansion of  $f$  has  $D$  as its domain of convergence. ►

**REMARK.** If instead of Taylor expansions we consider Laurent expansions, then we obtain a more general result: *the envelope of holomorphy of any relatively complete Reinhardt domain (see subsection 8) is its logarithmically convex hull.*

3. HARTOGS DOMAINS.<sup>(33)</sup> For simplicity of notation we restrict ourselves to domains with symmetry plane  $a_n = 0$ ; this does not reduce the generality.

**THEOREM 5.** *The envelope of holomorphy of a complete Hartogs domain  $D = \{z = ({}^1z, z_n) : {}^1z \in {}^1D, |z_n| < r({}^1z)\}$ , whose projection  ${}^1D$  is a domain of holomorphy in the space  $\mathbb{C}^{n-1}$ , is the Hartogs domain*

$$\widetilde{D} = \{z = ({}^1z, z_n) : {}^1z \in {}^1D, |z_n| < e^{V({}^1z)}\}, \quad (4)$$

where  $V({}^1z)$  is the best plurisuperharmonic majorant of the function  $\ln r({}^1z)$  in the domain  ${}^1D$ .

◄ In fact, by what was proved in subsection 8, any function  $f \in \mathcal{O}(D)$  is represented in  $D$  by its Hartogs series

$$f(z) = \sum_{\mu=0}^n g_\mu({}^1z) z_n^\mu, \quad (5)$$

and hence, extends holomorphically to the domain of convergence of this series,  $G_f = \{{}^1z \in D, |z_n| < R_f({}^1z)\}$ . The quantity  $R_f$  is obviously the Hartogs radius of the domain  $G_f$ . By the lemma of subsection 39 (see the remark following it) the function  $\ln R_f$  is plurisuperharmonic in  ${}^1D$ , i.e.,  $G_f$  is a domain of the form (4), where  $V = \ln R_f$  is some plurisuperharmonic majorant of the function  $\ln r$ . Thus, for any  $f \in \mathcal{O}(D)$  the domain  $G_f \supset \widetilde{D}$ ,

<sup>(33)</sup>For the definition of a Hartogs domain see subsection 2.

where  $\tilde{D}$  is the domain defined in (4), and since the envelope of holomorphy of  $D$  is the intersection of all such  $G_f$ , then this envelope contains  $\tilde{D}$ .

It remains to prove that  $\tilde{D}$  is a domain of holomorphy. Since by hypothesis  $'D$  is a domain of holomorphy, it is pseudoconvex, i.e., there exists a plurisubharmonic function  $u_1('z)$  in  $'D$ , tending to  $+\infty$  in the approximation to the boundary. Furthermore, since  $V$  is plurisuperharmonic, the function  $\ln(|z_n|/e^V) = \ln|z_n| - V$  and by Theorem 3 of subsection 38 the function  $u_2(z) = -\ln \ln(e^V/|z_n|)$  as well are plurisubharmonic in  $\tilde{D}$ . But then the function  $u(z) = \max(u_1('z), u_2(z))$  is also plurisubharmonic in  $\tilde{D}$ , and when approaching  $\partial\tilde{D}$  it tends to  $+\infty$ . Therefore  $\tilde{D}$  is pseudoconvex and by Theorem 4 of subsection 39 it is a domain of holomorphy. ►

REMARK. If we consider Hartogs-Laurent expansions, then we can obtain a more general result: *the envelope of holomorphy of the domain  $D = \{'z, z_n\} : 'z \in 'D, r_1('z) < |z_n| < r_2('z)\}$ , whose projection  $'D$  is a domain of holomorphy in  $\mathbb{C}^{n-1}$ , is a domain of the form*

$$\tilde{D} = \{'z, z_n\} : 'z \in 'D, e^{v_1('z)} < |z_n| < e^{V_2('z)}, \tag{6}$$

where  $v_1$  is the best plurisubharmonic minorant of the function  $\ln r_1$  and  $V_2$  is the best plurisuperharmonic majorant of  $\ln r_2$ .<sup>(34)</sup>

In Theorem 5 (and its generalization) it is essential that the projection  $'D$  of  $D$  be a domain of holomorphy; otherwise the domains (4) and (6) will not be envelopes of holomorphy, but only holomorphic extensions of  $D$ . We remark that not every Hartogs domain has a one-sheeted envelope. To see this it suffices to take the Hartogs domain in  $\mathbb{C}^3$  whose projection in  $\mathbb{C}^2$  is the domain from the example in subsection 33 with a multiple-sheeted envelope.

**41. Multiple-sheeted envelopes.** We now wish to consider questions of the extension of Riemann domains (see subsection 22) and the extension of holomorphic functions on them. To do this we need first of all to extend the concept of embedding to such domains.

DEFINITION 1. Suppose we are given two Riemann domains  $(D_1, \pi^1)$  and  $(D_2, \pi^2)$  over  $\mathbb{C}^n$ ; if there exists a continuous mapping  $\varphi: D_1 \rightarrow D_2$  such that on  $D_1$

$$\pi^1 = \pi^2 \circ \varphi, \tag{1}$$

then we say that the first domain is *weakly  $\varphi$ -embedded* in the second, and we write  $(D_1, \pi^1) \underset{\varphi}{\subset} (D_2, \pi^2)$ . If  $\varphi$  here is a ONE-TO-ONE mapping of  $D_1$  into  $D_2$ , then we say that  $(D_1, \pi^1)$  is  *$\varphi$ -embedded* in  $(D_2, \pi^2)$ . And if  $\varphi$

<sup>(34)</sup>See V. S. VLADIMIROV, *Methods of the theory of functions of several complex variables*, Chapter III, §21, subsection 3, "Nauka", Moscow, 1964, p. 217; English transl., MIT Press, Cambridge, MA, 1966.

is a HOMEOMORPHISM of  $D_1$  onto  $D_2$ , then  $(D_1, \pi^1)$  and  $(D_2, \pi^2)$  are said to be *equivalent*.

This definition generalizes the usual concept of embedding: if  $D_1 \subset D_2$  in the usual sense, then  $\pi^1 = \pi^2|_{D_1}$  is the restriction of the function  $\pi^2$  to  $D_1$ , and we can take as  $\varphi$  the natural embedding  $\varphi: D_1 \rightarrow D_2$ , where  $\varphi$  takes each point  $p \in D_1$  to the same point  $p$ , considered as a point of  $D_2$ .<sup>(35)</sup> It is obvious that equivalent domains  $(D_1, \pi^1)$  and  $(D_2, \pi^2)$  are embedded in each other (one by means of  $\varphi$  and the other by means of  $\varphi^{-1}$ ). In the case of a weak embedding  $(D_1, \pi^1) \subset_{\varphi} (D_2, \pi^2)$  the first domain may turn out to be "more ramified" than the second. Thus, the Riemann surface of the function  $w = \sqrt[3]{z}$  over  $\mathbb{C}^1$  is weakly embedded in the Riemann surface of  $w = \sqrt{z}$  (for  $\varphi$  we need to take the mapping that coalesce pairs of points of the first surface at which  $\sqrt{z}$  takes the same values). Every Riemann domain  $\pi: D \rightarrow \mathbb{C}^n$  is weakly  $\pi$ -embedded in  $\mathbb{C}^n$ .

We note that the imbedding map  $\varphi: D_1 \rightarrow D_2$  (even for a weak embedding) of Riemann domains  $(D_1, \pi^1)$  and  $(D_2, \pi^2)$  over  $\mathbb{C}^n$  is certainly holomorphic. In fact, since  $\pi^1$  is a homeomorphism in a neighborhood of the point  $p_0 \in D_1$  by condition (1) we have  $\pi^2 \circ \varphi \circ \pi^1|_U^{-1}(z) \equiv z$ , where  $\pi^1|_U$  is the restriction of  $\pi^1$  and  $z = \pi^1(p)$  (see the definition of a holomorphic mapping of manifolds in subsection 12). Equivalence of Riemann domains means that they are biholomorphically equivalent.

**DEFINITION 2.** Let  $(D_1, \pi^1)$  and  $(D_2, \pi^2)$  be two Riemann domains over  $\mathbb{C}^n$ , where  $D_1 \subset_{\varphi} D_2$  and  $f_2: D_2 \rightarrow \mathbb{C}$  is a function in the second domain. The function  $f_1: D_1 \rightarrow \mathbb{C}$  is called the  $\varphi$ -restriction of  $f_2$  to  $D_1$  (notation:  $f_1 = f_2|_{D_1}^{\varphi}$  if, for all  $p \in D_1$ ,

$$f_1(p) = f_2 \circ \varphi(p); \tag{2}$$

the function  $f_2$  is then called the  $\varphi$ -extension of  $f_1$ .

If  $D_1 \subset D_2$  and  $\varphi$  is the natural embedding, then we have the usual restriction  $f_1 = f_2|_{D_1}$ .

In order to formulate the definition of a multiple-sheeted envelope of holomorphy we will say that a complex manifold  $M$  is *holomorphically separated* if, for any two distinct points  $p, q \in M$  there is a function  $f \in \mathcal{O}(M)$  separating these points, i.e., such that  $f(p) \neq f(q)$ .

If  $M$  is a submanifold of  $\mathbb{C}^n$  (in particular, if it is a one-sheeted domain), then the condition of being holomorphically separated automatically holds, since we can take one of the coordinates as the separating function. But in the general case this is not so: consider, for example, the two-sheeted covering  $\tilde{D}$  of the domain  $D = \mathbb{C}^2 \setminus \Gamma$ , where  $\Gamma = \{|z_1| = 1, |z_2| = 1\}$  is the torus, whose Reinhardt figure is shown in Figure 43 (this is a piece of a two-sheeted

---

<sup>(35)</sup>Since the mapping  $\varphi(p) \equiv p$  is one-to-one, then the usual embedding is a  $\varphi$ -embedding.

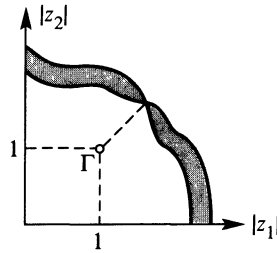

FIGURE 43

Riemann surface with branch points  $(1, 1)$  and  $\infty$ ).

Consider an arbitrary function  $f$  that is holomorphic on  $\tilde{D}$ . Its values on either of the two “sheets” of  $\tilde{D}$  are holomorphic over  $\{|z| > \sqrt{2}\}$ , since the branch manifold (the torus  $\Gamma$ ) lies on the sphere  $\{|z| = \sqrt{2}\}$  and outside the ball the covering is unramified. By the theorem on compact singularities (subsection 31) these values extend to entire functions, and since they must coincide on  $\Gamma$ , they coincide identically (see Problem 9 to Chapter I). Thus, the values of  $f$  at points of different sheets of the domain  $\tilde{D}$  lying over a single point  $z \in \mathbb{C}^2$  must coincide: the points of  $\tilde{D}$  with the same projection are not holomorphically separated.

**DEFINITION 3.** A holomorphically separated Riemann domain  $(\tilde{D}, \tilde{\pi})$  is called an *envelope of holomorphy* of a Riemann domain  $(D, \pi)$  if: (1) there exists a  $\varphi$ -embedding  $D \subset_{\varphi} \tilde{D}$  such that any function  $f \in \mathcal{O}(D)$  admits a  $\varphi$ -extension to a function  $\tilde{f} \in \mathcal{O}(\tilde{D})$ ; (2) for any point  $p \in \tilde{D}$  there is a function  $f_0 \in \mathcal{O}(\tilde{D})$  for which the restriction  $f_0 \circ \tilde{\pi}^{-1}$  to the polydisc  $U(z^0, \rho)$ , where  $z^0 = \tilde{\pi}(p)$  and  $\rho = \rho(p, \partial\tilde{D})$ , does not have a holomorphic extension to any polydisc  $U(z^0, R)$  of radius  $R > \rho$  (cf. the definition in subsection 40; the replacement of the ball by a polydisc is not essential).

As we saw, the problem of constructing an envelope of holomorphy in the class of (one-sheeted) domains in  $\mathbb{C}^n$  is not always solvable. Here we shall prove that this problem is always solvable in the class of Riemann domains. At the basis of the proof lies the process of simultaneous analytic continuation of families of holomorphic functions and we shall construct the envelope from the germs of these families.

We consider a pair  $(U, F)$  consisting of a polydisc  $U \subset \mathbb{C}^n$  and some family of functions  $F \subset \mathcal{O}(U)$ ; we shall assume the family to be indexed by a parameter:  $F = \{f_{\alpha}\}_{\alpha \in A}$ . Fix an arbitrary point  $z \in U$ ; we shall say that a second such pair  $(V, G)$  is *equivalent* to the first at the point  $z$  if the polydisc  $V \ni z$  and the family  $G$  can be indexed by the same parameter ( $G = \{g_{\alpha}\}_{\alpha \in A}$ ) so that  $f_{\alpha}(z) = g_{\alpha}(z)$  for all  $\alpha \in A$  and all  $z \in U \cap V$ . An equivalence class under this relation is called the *germ of the family  $F$*  at the point  $z$  and is denoted by the symbol  $F_z$  (in particular, if  $F$  consists of a single function  $f$ , we obtain the usual germ  $f_z$ ).



We introduce a topology in the space  $\mathfrak{R}^n$  of all germs of all possible families of holomorphic functions in the usual way: let  $F_a$  be some germ and let  $(U, F)$  be a representative of it; a neighborhood of the point  $F_a$  is the set of germs  $G_z$ ,  $z \in U$ , which have representatives equivalent to  $(U, F)$  at the point  $z$ . It is not hard to see that the space  $\mathfrak{R}^n$  together with the projection  $\pi: \mathfrak{R}^n \rightarrow \mathbb{C}^n$  is a sheaf over  $\mathbb{C}^n$  (if we consider only families consisting of a single function, we obtain the sheaf of germs of holomorphic functions; see subsection 28).

The connected and open subsets of  $\mathfrak{R}^n$  are obviously Riemann domains. A special role is played by the *components* of  $\mathfrak{R}^n$ , i.e., its maximal connected subsets; since  $\mathfrak{R}^n$  is locally connected, they are open sets, i.e., domains. These components are maximal not only with respect to being connected, but also with respect to simultaneous analytic continuation. Namely, we have

**THEOREM 1.** *Any component  $\tilde{D}$  of the space  $\mathfrak{R}^n$  coincides with its envelope of holomorphy.*

◀ We take the identity mapping as the mapping  $\varphi$  of Definition 3; then condition (1) of the definition holds automatically and we only have to verify condition (2). Suppose that it does not hold, i.e., there exists a point  $p^0 \in \tilde{D}$  such that for all functions  $\hat{f} \in \mathcal{O}(\tilde{D})$  the restrictions of  $\hat{f} \circ \pi^{-1}$  to the polydisc  $U(a, r)$ , where  $a = \pi(p^0)$  and  $r = \rho(p^0, \partial\tilde{D})$ , extend to the polydisc  $U(a, R)$  of radius  $R > r$ . By the construction of  $\mathfrak{R}^n$  the point  $p^0$  is the germ at the point  $a \in \pi(\tilde{D})$  of some indexed family  $F = \{f_\alpha\}$  of holomorphic functions. Since for any fixed  $\alpha$  the value of  $f_\alpha(z)$  is the same for all representatives of the germ  $F_z = p$ , then  $f_\alpha \circ \pi(p)$  can be considered as a function on  $\tilde{D}$ , which is obviously holomorphic. By our assumption, all the  $f_\alpha \circ \pi \circ \pi^{-1} = f_\alpha$  extend holomorphically into the polydisc  $U(a, R)$ , and hence the germs of the family  $F$  at points of this polydisc form a polydisc  $\tilde{U}$  on  $\mathfrak{R}^n$  with center  $p^0$  and radius  $R$ . Since the component  $\tilde{D}$  is maximal, it contains  $\tilde{U}$  and this contradicts the fact that  $\rho(p^0, \partial\tilde{D}) = r < R$ . ▶

The space  $\mathfrak{R}^n$  is universal: every Riemann domain can be weakly  $\varphi$ -embedded (in the sense of Definition 1) in some component of  $\mathfrak{R}^n$  in such a way that the holomorphic functions in the domain  $\varphi$ -extend (in the sense of Definition 2) to this component. This is established by

**THEOREM 2.** *For any Riemann domain  $(D, \pi)$  and any family  $F \subset \mathcal{O}(D)$  there are a component  $\tilde{D}_F$  of  $\mathfrak{R}^n$  and a mapping  $\varphi: D \rightarrow \tilde{D}_F$  such that  $D \subset_{\varphi} \tilde{D}_F$  and any  $f_\alpha \in F$  is the  $\varphi$ -restriction of some function  $\hat{f}_\alpha \in \mathcal{O}(\tilde{D}_F)$ .*

◀ For any point  $p \in D$  we denote by  $\varphi(p) = F_z$  the germ at the point  $z = \pi(p)$  of the family  $F \circ \pi^{-1}$ ; the mapping  $\varphi: D \rightarrow \mathfrak{R}^n$  that we have defined is obviously continuous. By the definition of the projection on  $\mathfrak{R}^n$  we have  $\pi: F_z \rightarrow z$ , so that  $\pi \circ \varphi(p) \equiv \pi(p)$  and  $\varphi$  is a weak embedding.

The image  $\varphi(D)$  is connected and, hence, belongs to some component  $\tilde{D}_F$  of  $\mathfrak{R}^n$ .

For any point  $p \in D$  and function  $f_\alpha \in F$  we denote by  $\tilde{f}_\alpha$  the function which associates the value  $f_\alpha(p)$  to the germ  $\varphi(p) = F_z$ ; this function obviously has a holomorphic extension to  $\tilde{D}_F$ . By construction  $f_\alpha(p) = \tilde{f}_\alpha \circ \varphi(p)$ , so that the condition of Definition 2 holds and  $f_\alpha = \tilde{f}_\alpha|_D^\varphi$ . ►

We now proceed to the proof of the main theorem in this section, which concerns the existence of an envelope of holomorphy and its uniqueness up to equivalence in the sense of Definition 1.

**THEOREM 3.** *Let  $(D, \pi)$  be an arbitrary holomorphically separated Riemann domain and let  $\mathcal{O} = \mathcal{O}(D)$  be the family of all functions that are holomorphic in  $D$ . Then the component  $\tilde{D}_\mathcal{O}$  that corresponds to  $D$  by Theorem 2 is an envelope of holomorphy of  $D$  and any envelope of holomorphy of  $D$  is equivalent to  $\tilde{D}_\mathcal{O}$ .*

◀ Let  $\varphi: D \rightarrow \tilde{D}_\mathcal{O}$  be the mapping described in the proof of Theorem 2. Since  $D$  is holomorphically separated, then for any distinct points  $p, q \in D$  there is a function  $f_\alpha \in \mathcal{O}(D)$  such that  $f_\alpha(p) \neq f_\alpha(q)$ , and, hence, the germs of the family  $\mathcal{O}$  at these points are distinct, i.e.,  $\varphi(p) \neq \varphi(q)$ . Thus, the mapping  $\varphi$  is one-to-one, i.e., is an embedding, and condition (1) of the definition of an envelope of holomorphy holds. Condition (2) of the definition holds by Theorem 1, and the first part of the theorem has been proved.

In order to prove the second part we assume that  $(\tilde{G}, \tilde{\pi})$  is another envelope of holomorphy of the domain  $D$  and that  $\psi: D \rightarrow \tilde{G}$  is the corresponding embedding. In the domain  $\varphi(D) \subset \tilde{D}_\mathcal{O}$  the biholomorphic mapping  $\chi = \psi \circ \varphi^{-1}$  into  $\tilde{G}$  is defined, and, by Definition 1, everywhere in  $\varphi(D)$  we have

$$\tilde{\pi} \circ \chi(p) = \pi(p). \quad (3)$$

Since  $\tilde{D}_\mathcal{O}$  is an envelope of holomorphy of  $D$ , then  $\chi$  extends to a holomorphic mapping  $\tilde{D}_\mathcal{O} \rightarrow \tilde{G}$ . In fact, from (3) we see that locally  $\chi = \tilde{\pi}^{-1} \circ \pi$  and an obstruction to extending this mapping can occur only in case there exists a point  $p \in \tilde{D}_\mathcal{O}$  in the approach to which  $\chi(p)$  tends to  $\partial\tilde{G}$ . But since  $\tilde{G}$  is not locally extendable to its boundary points, then there is a function  $\tilde{g} \in \mathcal{O}(\tilde{G})$  such that  $\tilde{f} = \tilde{g} \circ \chi$  does not have a holomorphic extension to the point  $p$ . But this is impossible, since in  $D$  we have  $\tilde{f} \circ \varphi = \tilde{g} \circ \psi$  and by the definition of a domain of holomorphy  $\tilde{f}$  must extend to a function that is holomorphic in  $\tilde{D}_\mathcal{O}$ .

Thus,  $\chi$  maps  $\tilde{D}_\mathcal{O}$  holomorphically into  $\tilde{G}$ , and since the preceding argument can be carried out also for the mapping equal to  $\chi^{-1} = \varphi \circ \psi^{-1}$  in  $\psi(D)$ , then  $\chi$  is a biholomorphic mapping of  $\tilde{D}_\mathcal{O}$  onto  $\tilde{G}$ . Since it obviously preserves the projection,  $\tilde{G}$  is equivalent to  $\tilde{D}_\mathcal{O}$ . ►

To conclude we shall consider Riemann domains of holomorphy.

**DEFINITION 4.** A Riemann domain  $(D, \pi)$  is called a *domain of holomorphy* if there exists a function  $f \in \mathcal{O}(D)$  that possesses the following property: if  $(D_1, \pi^1) \xrightarrow{\varphi} (D, \pi)$  and the function  $f_1 \in \mathcal{O}(D_1)$  is a  $\varphi$ -extension of  $f$ , then it follows that  $(D_1, \pi^1)$  is equivalent to  $(D, \pi)$  (i.e., that  $\varphi$  maps  $D$  one-to-one onto  $D_1$ ).

From Theorem 3 we see that all envelopes of holomorphy of holomorphically separated Riemann domains are domains of holomorphy. A necessary and sufficient condition for domains of holomorphy is given by

**THEOREM 4 (Cartan-Thullen).** *A Riemann domain  $(D, \pi)$  is a domain of holomorphy if and only if it is holomorphically convex<sup>(36)</sup> and holomorphically separated.*

We shall not present a detailed proof; we describe only the changes that need to be introduced in the multiple-sheeted case.

◀ *Necessity.* The proof of the lemma on simultaneous extension (subsection 33) carries over without essential changes to Riemann domains, and from this theorem we obtain that a domain of holomorphy  $D$  is holomorphically convex.

To prove that it is holomorphically separated, by Theorem 2 we  $\varphi$ -embed the domain  $D$  with the family  $F$  consisting of the single function  $f$  from Definition 4 into the space  $\mathbb{R}^n$ , and, according to the same definition, the mapping  $\varphi$  is one-to-one. Let  $p$  and  $q$  be distinct points of  $D$ ; then  $\varphi(p) \neq \varphi(q)$ , and hence, by construction of the function  $\varphi$  the germs of  $f \circ \pi^{-1}$  at the points  $\pi(p)$  and  $\pi(q)$  are different, and this means that the values of the function  $f$  or any of its derivatives are different at the points  $p$  and  $q$ .

*Sufficiency.* Let  $K_\nu$  ( $\nu = 1, 2, \dots$ ) be a compact exhaustion of the domain  $D$ . Using the holomorphic convexity of  $D$ , we may assume that  $K_\nu = (\widehat{K}_\nu)_{\mathcal{O}(D)}$ . We cover  $\partial K_\nu$  by a finite number of polydiscs and in the intersection of each of them with  $D \setminus K_\nu$  we take a point  $p_{\nu_j}$  ( $j = 1, \dots, k_\nu$ ); we denote by  $f_{\nu_j}$  a function from  $\mathcal{O}(D)$  such that

$$f_{\nu_j}(p_{\nu_j}) = \nu, \quad \|f_{\nu_j}\|_{K_\nu} < 2^{-\nu-j}, \quad \text{and} \quad f_{\nu_j}(p_{\nu_k}) = 0, \quad j \neq k.$$

The function  $f = \sum f_{\nu_j} \in \mathcal{O}(D)$ , and

$$|f(p_{\nu_j})| \geq \nu - 1. \tag{4}$$

Using the holomorphic separability, we can correct the function  $f$  so that, while remaining holomorphic in  $D$  and satisfying the inequality (4), it will

<sup>(36)</sup>The definition of holomorphic convexity carries over without changes to Riemann domains. For example, it can be formulated as the condition  $\rho(K, \partial D) = \rho(\widehat{K}_\emptyset, \partial D)$ , where  $K$  is an arbitrary compact subset of  $D$  and  $\widehat{K}_\emptyset$  is its hull relative to the class of functions holomorphic on  $D$ .

have distinct elements at any two distinct points  $p, q \in D$  with the same projection  $\pi(p) = \pi(q)$  (as for how to realize this correction, see the book by B. A. Fuks,<sup>(37)</sup> p. 193).

We shall show that  $(D, \subset)$  is the domain of holomorphy of the (corrected) function  $f$ . Suppose there is a  $\varphi$ -extension of the function  $f$  into a domain  $(D_1, \pi^1)$ ; we must prove that  $\varphi$  maps  $D$  one-to-one onto  $D_1$ . If  $\varphi(p) = \varphi(q)$ , then by Definitions 1 and 2  $\pi(p) = \pi(q)$  and  $f(p) = f(q)$ . From this by the construction of  $f$  it follows that  $p = q$ . Moreover,  $\varphi(D) = D_1$ , since otherwise the domain  $\varphi(D)$  would have a boundary point in  $D_1$ , and in view of inequality (4) the function  $f_1 = f \circ \varphi$  cannot be holomorphic at this point. ►

REMARK. K. Oka proved in 1953 that every holomorphically convex Riemann domain over  $\mathbb{C}^n$  is holomorphically separated. Therefore the conditions in Theorem 4 are not independent.

Riemann domains that are domains of holomorphy belong to the important class of *Stein manifolds*. A Stein manifold is an  $n$ -dimensional complex manifold  $M$ , possessing the properties: (1) holomorphic convexity, (2) holomorphic separability, (3) for any point  $p \in M$  there exist  $n$  functions  $f_\nu \in \mathcal{O}(M)$  which form local coordinates in a neighborhood of  $p$ .

We state without proof<sup>(38)</sup> some properties of Stein manifolds which show that these manifolds are a natural generalization of domains of holomorphy.

(I) *A complex manifold  $M$  is a Stein manifold if and only if on  $M$  there exists a smooth strictly plurisubharmonic function  $u$  that grows unbounded on its boundary, i.e., such that the sets  $\{p \in M : u(p) < \alpha\} \subset\subset M$  for any  $\alpha \in \mathbb{R}$ .*

(II) *If a Stein manifold  $M$  is an open subset of a complex manifold  $\widetilde{M}$  (with the induced complex structure), then there exists a function  $f \in \mathcal{O}(M)$  that does not have a holomorphic extension to points of  $\widetilde{M} \setminus M$ .*

We also note that an  $n$ -dimensional Stein manifold can be embedded in  $\mathbb{C}^{2n+1}$  as a closed submanifold, or, in other words,

(III) *For any Stein manifold  $M$  there exists a proper holomorphic embedding<sup>(39)</sup>  $f: M \rightarrow \mathbb{C}^{2n+1}$ , where  $n = \dim_{\mathbb{C}} M$ .*

**42. Analyticity of the set of singularities.** To conclude this chapter we consider some questions related to singular points of analytic functions in a general treatment of them. The treatment is as follows: each function  $f$

<sup>(37)</sup>B. A. FUKS, *Introduction to the theory of analytic functions of several complex variables*, Fizmatgiz, Moscow, 1962; English transl., Transl. Math. Monographs, vol. 8, Amer. Math. Soc., Providence, RI, 1963.

<sup>(38)</sup>The proofs of these assertions can be found in the book by L. HÖRMANDER, *An introduction to complex analysis in several variables*, Van Nostrand, Princeton, NJ, 1966; see Theorems 5.2.10, 5.4.2, and 5.3.9 there.

<sup>(39)</sup>Recall that a mapping  $f: M \rightarrow N$  is said to be *proper* if the inverse image of each compact subset  $\widetilde{N}$  is a compact subset of  $M$ . The mapping  $f$  is called an *embedding* if it is a diffeomorphism of  $M$  onto  $f(M)$ .

that is holomorphic in some domain of  $\mathbb{C}^n$  can be extended analytically into its (one-sheeted or Riemann) domain of holomorphy; the boundary points of the latter are called the *singular points* of the function  $f$ .

In the general case the set of singular points has real dimension  $2n - 1$  and does not necessarily possess any smoothness properties. However, in some important special cases one can prove that this set is analytic. We begin with the EMBEDDED EDGE theorem (1932), which is useful in a number of applications.

**THEOREM 1 (K. Kneser).** *Suppose that two real hypersurfaces  $S_j = \{z \in \mathbb{C}^n : \varphi_j(z) = 0\}$  of class  $C^2$  intersect in a  $(2n - 2)$ -dimensional edge  $\Gamma$  in general position, i.e., such that everywhere on  $\Gamma$  we have<sup>(40)</sup>*

$$d\varphi_1 \wedge d\varphi_2 \neq 0, \tag{1}$$

and the function  $f$  is holomorphic in the part of  $\Gamma$  where at least one of the  $\varphi_j < 0$  (Figure 44). If  $f$  does not extend holomorphically to any point of  $\Gamma$ , then  $\Gamma$  is a complex hypersurface.

◀ (a) Suppose there exists a point  $a \in \Gamma$  at which

$$\partial\varphi_1 \wedge \partial\varphi_2 \neq 0. \tag{2}$$

Consider the function  $\varphi = \varphi_1 + \varphi_2 - k(\varphi_1^2 + \varphi_2^2)$ , where  $k > 0$  is a constant that we shall soon choose. Since  $\varphi_1(a) = \varphi_2(a) = 0$ , then by property (b) of the Levi form from subsection 37 we have

$$H_a(\varphi, \omega) = H_a(\varphi_1, \omega) + H_a(\varphi_2, \omega) - 2k(|\partial\varphi_1(\omega)|^2 + |\partial\varphi_2(\omega)|^2), \tag{3}$$

where  $\partial\varphi_j(\omega) = (\omega, \overline{\nabla\varphi_j})$  is the Hermitian scalar product of the vector  $\omega \in \mathbb{C}^n$  by the normal  $n_j = \overline{\nabla\varphi_j}$  to the surface  $S_j$  at the point  $a$  (see subsection 17).

The equation of the complex tangent plane  $T_a^c(S)$  to the surface  $S = \{\varphi(z) = 0\}$  at the point  $a$  obviously has the form  $(z - a, n_1 + n_2) = 0$ ,

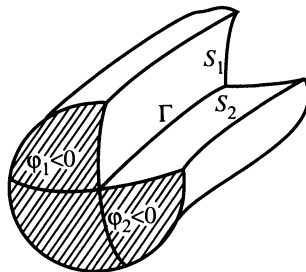

FIGURE 44

<sup>(40)</sup>Condition (1) means that on  $\Gamma$  the rank of the matrix  $(\partial\varphi_j/\partial z_k, \partial\varphi_j/\partial \bar{z}_k)$ , where  $j = 1, 2$  and  $k = 1, \dots, n$ , is equal to 2.

so that  $\omega \in T_a^c(S)$  if and only if  $(\omega, n_1 + n_2) = 0$ . But condition (2) geometrically means that the vectors  $n_1 = \overline{\nabla\varphi_1}$  and  $n_2 = \overline{\nabla\varphi_2}$  are complex-linearly independent (see subsection 17); therefore when the condition is satisfied, there is a vector  $\omega \in T_a^c(S)$  such that  $\partial\varphi_j(\omega) = (n, n_j) \neq 0$ ,  $j = 1$  or  $2$ . (In fact, if  $(\omega, n_j) = 0$  for all  $\omega \in T_a^c(S)$ , then both vectors  $n_j$  are complex orthogonal to the hyperplane  $T_a^c(S)$ , and hence, are complex proportional to each other.)

For such  $\omega$  we can choose a  $k$  so large that

$$2k(|(\omega, n_1)|^2 + |(\omega, n_2)|^2) > H_a(\varphi_1, \omega) + H_a(\varphi_2, \omega),$$

and then according to (3) the Levi form  $H_a(\varphi, \omega) < 0$ . By the Corollary of the Levi-Krzoska theorem of subsection 37 we can assert that any function that is holomorphic in the part of a neighborhood of the point  $a$  where  $\varphi < 0$  extends holomorphically to this point. But the function  $\varphi = \varphi_1(1 - k\varphi_1) + \varphi_2(1 - k\varphi_2)$  is positive for  $0 < \varphi_1 < 1/k$  and  $0 < \varphi_2 < 1/k$ , and hence the surface  $S = \{\varphi = 0\}$  in a neighborhood of  $a$  lies where at least one  $\varphi_j < 0$ . In this part the function  $f$  considered in the theorem is holomorphic by assumption. But the part of the neighborhood of  $a$  where  $\varphi < 0$  also lies there, and hence, by what we just proved  $f$  extends holomorphically to the point  $a$  contrary to the hypotheses.

Thus, case (a) is eliminated and at all points of  $\Gamma$

$$\partial\varphi_1 \wedge \partial\varphi_2 = 0. \tag{4}$$

(b) Condition (4) means that at all points  $z \in \Gamma$  the vectors  $n_1 = \overline{\nabla\varphi_1}$  and  $n_2 = \overline{\nabla\varphi_2}$  are complex proportional, i.e., that  $T_z^c(S_1) = T_z^c(S_2)$ , and hence,  $T_z^c(\Gamma) = T_z^c(S_1) \cap T_z^c(S_2) = T_z^c(S_j)$  has real dimension  $2n - 2$ . But according to the condition (1) the real tangent planes  $T_z(S_1)$  and  $T_z(S_2)$  are distinct and  $T_z(\Gamma) = T_z(S_1) \cap T_z(S_2)$  has the same dimension  $2n - 2$ . Therefore  $T_z(\Gamma) = T_z^c(\Gamma)$  at all points  $z \in \Gamma$  and by the theorem of Levi-Civita from subsection 17 we conclude that  $\Gamma$  is a complex hypersurface. ►

\* Prove that a function  $f$  that is holomorphic in the part of a neighborhood of the torus  $\Gamma = \{z \in \mathbb{C}^2 : |z_1| = |z_2| = 1\}$  where either  $|z_1| < 1$  or  $|z_2| < 1$  extends holomorphically to  $\Gamma$ . \*

**COROLLARY.** *If the function  $f$  is holomorphic in some  $2n$ -dimensional neighborhood of a  $(2n - 2)$ -dimensional surface  $\Gamma \subset \mathbb{C}^n$  of class  $C^2$  and if  $f$  does not extend holomorphically to  $\Gamma$ , then  $\Gamma$  is a holomorphic surface.*

◀ Let  $z^0 \in \Gamma$  be an arbitrary point. Since  $\Gamma \subset \mathbb{C}^2$  and is a  $(2n - 2)$ -dimensional surface, then in a neighborhood of  $z^0$  it is given by two real equations  $\varphi_1 = 0$ ,  $\varphi_2 = 0$ , where  $\varphi_j \in C^2$ , and in this neighborhood  $d\varphi_1 \wedge d\varphi_2 \neq 0$ . Since  $f$  is certainly holomorphic in the part of the neighborhood of  $\Gamma$  where  $\min(\varphi_1, \varphi_2) < 0$ , and since it does not extend to  $\Gamma$ , then  $\Gamma$  is a holomorphic surface. ►

In this corollary the analyticity of the set of singularities is ensured by its smoothness and its being of codimension 2. In the following, more classical result (1909) the smoothness of the set of singularities is not assumed, but then it is required that it intersect lines parallel to some direction at at most one point.

**THEOREM 2 (Hartogs).** *Let  $a$  be a singular point of the function  $f$ , and for each point  $'z$ ,  $\| 'z - 'a \| < \varepsilon$ , in the polydisc  $U(a, \varepsilon)$  there is at most one point  $( 'z, z_n )$  that is singular for this function. Then there is a polydisc  $'V(a, \delta)$  such that to each  $'z \in 'V$  there corresponds exactly one number  $z_n$  for which  $( 'z, z_n )$  is a singular point of  $f$  in  $U$ , and the function  $z_n = g( 'z )$  is holomorphic in  $'V$ .*

◀ (a) **CONTINUITY** of the function  $g$ . Without loss of generality we may assume that  $a = 0$ . Since 0 is the unique singular point of  $f$  with projection  $'0$ , then the circle  $\gamma_0 = \{ 'z = '0, |z_n| = \eta \}$ ,  $0 < \eta < \varepsilon$ , belongs to the domain of holomorphy of  $f$ . The family of discs  $K_b = \{ 'z = 'b, |z_n| \leq \eta \}$  tends to  $K_0 = \{ 'z = '0, |z_n| \leq \eta \}$  as  $'b \rightarrow '0$ , and  $\partial K_b \rightarrow \partial K_0 = \gamma_0$ . Since  $K_0$  contains the singular point 0, then by the continuity principle (subsection 36) there is a  $\delta > 0$  such that for  $\| 'b \| < \delta$  in the disc  $K_b$  there is at least one singular point of  $f$ . By hypothesis there cannot be more than one such point, and hence the function  $z_n = g( 'z )$  is uniquely determined in  $'V = \{ \rho( 'z, '0 ) < \delta \}$ . This same reasoning proves the continuity of  $g$  at the point  $'0$ : we have  $g( '0 ) = 0$  and for any  $\eta > 0$  there exists a  $\delta > 0$  such that  $|g( 'z )| < \eta$  for  $\| 'z \| < \delta$ . Since we can take any point of  $'V$  for  $'0$ , then  $g$  is continuous in all of  $'V$ .

(b) **HOLOMORPHY** of the function  $g$ . The number  $\delta$  can be assumed to be so small that  $|g( 'z )| < \frac{1}{3}\varepsilon$  for  $'z \in 'V$ , and then  $f$  will be holomorphic in the domain  $\{ 'z \in 'V, \frac{1}{3}\varepsilon < |z_n| < \frac{2}{3}\varepsilon \}$ . We choose a number  $\rho$ ,  $\frac{1}{3}\varepsilon < \rho < \frac{2}{3}\varepsilon$ , and a point  $z_n^0 = \rho e^{i\theta}$ ; then  $f$  will be holomorphic in the polydisc  $\{ 'z \in 'V, |z_n - z_n^0| < \rho - \frac{1}{3}\varepsilon \}$ . By construction for any  $'z \in 'V$  the point  $( 'z, g( 'z ) )$  is singular for  $f$ , and all the points  $( 'z, z_n )$  for which  $|z_n - z_n^0| < |g( 'z ) - z_n^0|$  are regular. Since the function  $g$  is continuous, then

$$R( 'z ) = |g( 'z ) - z_n^0| \tag{5}$$

is the Hartogs radius (see subsection 39). Since  $|g( 'z )| < \frac{1}{3}\varepsilon$  and  $|z_n^0| = \rho > \frac{1}{3}\varepsilon$ , then  $R( 'z ) \geq |z_n^0| - |g( 'z )| > 0$ , and hence,  $\ln R( 'z )$  is continuous in  $'V$ .

We deduce that  $g$  is holomorphic from the plurisubharmonicity of the function  $-\ln R( 'z )$ , which we proved in subsection 39. It suffices to prove that  $g$  is holomorphic with respect to each variable  $z_\nu$ ,  $\nu = 1, \dots, n-1$ , in some disc  $|z_\nu| < r$  for fixed  $z_\mu = a_\mu$ ,  $|a_\mu| < r$ ,  $\mu \neq \nu$ . For simplicity of notation we write  $R(z_\nu)$  instead of  $R(a_1, \dots, z_\nu, \dots, a_{n-1})$  and analogously  $g(z_\nu)$ . Since  $-\ln R(z_\nu)$  is subharmonic in the disc  $\{|z_\nu| < r\}$  and

continuous in  $\{|z_\nu| \leq r\}$ , then

$$\ln R(0) \geq \frac{1}{2\pi} \int_0^{2\pi} \ln R(re^{it}) dt$$

or, according to (5),<sup>(41)</sup>

$$\ln|g(0) - \rho e^{i\theta}| \geq \frac{1}{2\pi} \int_0^{2\pi} \ln|g(re^{it}) - \rho e^{i\theta}| dt. \quad (6)$$

This inequality holds for all  $\theta \in [0, 2\pi]$ ; integrating it with respect to  $\theta$  and changing the order of integration in the right-hand side (this is obviously legal), we will have

$$\int_0^{2\pi} \ln|g(0) - \rho e^{i\theta}| d\theta \geq \frac{1}{2\pi} \int_0^{2\pi} dt \int_0^{2\pi} \ln|g(re^{it}) - \rho e^{i\theta}| d\theta. \quad (7)$$

By the residue theory, for any  $w$ ,  $|w| < \rho$ , we have

$$\int_{\{|\zeta|=\rho\}} \ln \frac{\zeta - w}{\zeta} \cdot \frac{d\zeta}{\zeta} = 0,$$

from which we see that the integral

$$\int_0^{2\pi} \ln|\rho e^{i\theta} - w| d\theta = \operatorname{Re} \int_{\{|\zeta|=\rho\}} \ln(\zeta - w) \frac{d\zeta}{\zeta} = \operatorname{Re} \int_{\{|\zeta|=\rho\}} \ln \zeta \frac{d\zeta}{\zeta}$$

does not depend on  $w$ , i.e., is constant in the disc  $\{|w| < \rho\}$ . Since we have  $|g'(z)| < \rho$  for all  $z \in V$ , then we can replace  $g(re^{it})$  in the right-hand side of (7) by the value of  $g(0)$ . But from this we see that (7), and hence (6) as well, becomes an equality for all  $\theta$ , i.e., the subharmonic function  $-\ln|g(z_\nu) - \rho e^{i\theta}|$  at the point  $z_\nu = 0$  coincides with its harmonic majorant. From this it follows (see Part I, Appendix, subsection 3) that the function  $\ln|g(z_\nu) - \rho e^{i\theta}|$  is harmonic in the disc  $\{|z_\nu| < r\}$  for any  $\theta \in [0, 2\pi]$ .

From (5) we have

$$R^2 = (g - \rho e^{i\theta})(\bar{g} - \rho e^{-i\theta}) = g\bar{g} - \rho(e^{-i\theta}g + e^{i\theta}\bar{g}) + \rho^2, \quad (8)$$

and since  $\ln R$  is harmonic this function is of class  $C^\infty$  (with respect to the variables  $z_\nu$  and  $\bar{z}_\nu$ ) for any  $\theta$ . Forming the difference of the values of (8) for  $\theta = \theta_0$  and  $\theta = \theta_0 + \pi$ , we see that  $e^{-i\theta_0}g + e^{i\theta_0}\bar{g} \in C^\infty$ , and setting  $\theta_0 = 0$  and  $\pi/2$  here, we find that  $g + \bar{g}$ ,  $g - \bar{g} \in C^\infty$ , and hence  $g \in C^\infty$ . It remains to prove that  $\frac{\partial g}{\partial \bar{z}_\nu} \equiv 0$ .

For this we use the fact that along with  $\ln R$  the function  $\ln R^2$  is also a harmonic function of  $z_n$  for any  $\rho \in (\frac{1}{3}\varepsilon, \frac{2}{3}\varepsilon)$  and any  $\theta \in [0, 2\pi]$ . The Laplace equation for  $\ln R^2$  has the form

$$R^2 \frac{\partial^2 R^2}{\partial z_\nu \partial \bar{z}_\nu} - \frac{\partial R^2}{\partial z_\nu} \frac{\partial R^2}{\partial \bar{z}_\nu} = 0,$$

<sup>(41)</sup>In this formula  $g(0) = g(a_1, \dots, 0, \dots, a_{n-1})$  is not necessarily equal to 0.



and the function (8) must satisfy it for any  $\rho$  and  $\theta$  from the intervals indicated. Substituting expression (8) here and setting the coefficient of  $\rho^3$  equal to 0, we find that

$$e^{-i\theta} \frac{\partial^2 g}{\partial z_\nu \partial \bar{z}_\nu} + e^{i\theta} \frac{\partial^2 \bar{g}}{\partial z_\nu \partial \bar{z}_\nu} = 0$$

for any  $\theta$ , whence  $\frac{\partial^2 g}{\partial z_\nu \partial \bar{z}_\nu} \equiv 0$  for  $|z_\nu| < r$ . Setting the coefficient of  $\rho^2$  equal to zero (taking this into account), we obtain that

$$e^{2i\theta} \frac{\partial \bar{g}}{\partial \bar{z}_\nu} \frac{\partial \bar{g}}{\partial z_\nu} + e^{-2i\theta} \frac{\partial g}{\partial z_\nu} \frac{\partial g}{\partial \bar{z}_\nu} = 0$$

for any  $\theta$ , and hence,  $\frac{\partial g}{\partial z_\nu} \frac{\partial g}{\partial \bar{z}_\nu} \equiv 0$  for  $|z_\nu| < r$ .

Thus, at each point of the disc  $\{|z_\nu| < r\}$  either  $\frac{\partial g}{\partial z_\nu} = 0$  or  $\frac{\partial g}{\partial \bar{z}_\nu} = 0$ . In order to exclude the first possibility, we replace  $f(z_\nu, z_n)$  by the function  $f(z_\nu, z_n + z_\nu)$  (we will not write out the dependence on the other variables  $z_\mu$ ,  $\mu \neq \nu$ ,  $\mu \neq n$ ). It satisfies all the hypotheses of the theorem, and the equation of a singular surface for it will be  $z_n = g(z_\nu) - z_\nu$  instead of  $z_n = g(z_\nu)$ . Therefore, repeating our argument, we will find that for  $g$  in a neighborhood of  $z_\nu = 0$  one of the conditions  $\frac{\partial g}{\partial z_\nu} = 0$ ,  $\frac{\partial g}{\partial \bar{z}_\nu} - 1 = 0$  will also hold. Taking our previous derivation into account, we will find that  $\frac{\partial g}{\partial \bar{z}_\nu} \equiv 0$  in a neighborhood of  $z_\nu = 0$ . ►

There is also a more general result:

**THEOREM 3 (Hartogs).** *Let  $a \in \mathbb{C}^n$  be a singular point of the function  $f$  and suppose that, for each  $'z$ ,  $\|z - a\| < \varepsilon$ , in the polydisc  $U(a, \varepsilon)$  there exists a finite number of points  $(z, z_n^{(\mu)})$  that are singular for this function. Then in some neighborhood of  $a$  the singular points of  $f$  form an analytic set with the equation*

$$(z_n - a_n)^k + c_1('z)(z_n - a_n)^{k-1} + \dots + c_k('z) = 0, \quad (9)$$

where the functions  $c_\nu$  are holomorphic at the point  $'a$ .

### Problems

1. A "meromorphic curve" in a domain  $D \subset \mathbb{C}$  is a mapping  $f: D \rightarrow \bar{\mathbb{C}}^n$ , whose components are meromorphic functions in  $D$ . A "zero" of  $f$  is a point  $\zeta_0 \in D$  at which all the  $f_\nu(\zeta_0) = 0$ ; the lowest of the orders of the zeros of  $f_\nu$  ( $\nu = 1, \dots, n$ ) at this point is called the order of the zero of  $f$ . A "pole" of the curve  $f$  is a point  $\zeta_0 \in D$  at which at least one  $f_\nu(\zeta_0) = \infty$ ; the highest of the orders of the poles of the  $f_\nu$  at this point is called the order of the pole of  $f$ . Prove for meromorphic curves the following analogue of the argument principle:

$$N - P = \frac{1}{2\pi i} \int_{\partial D} \frac{(f', f)}{(f, f)} d\zeta + \frac{1}{2\pi i} \iint_D \frac{\partial}{\partial \bar{\zeta}} \frac{(f', f)}{(f, f)} d\zeta \wedge d\bar{\zeta}$$

(here it is assumed that  $\partial D$  is a smooth curve and that  $f$  extends holomorphically to  $\partial D$  and  $f \neq 0$  there;  $N$  and  $P$  are the numbers of zeros and poles of  $f$  in  $D$  including their orders;  $(z, w)$  is the Hermitian scalar product). Here the second term on the right-hand side is nonpositive and vanishes if and only if the curve  $f$  lies on a line passing through  $0 \in \mathbb{C}^n$ .

2. Prove the following generalization of the Martinelli-Bochner integral formula: if for a multi-index  $k = (k_1, \dots, k_n)$  we introduce the form

$$\omega_k(z) = \frac{(n-k)!k!}{(2\pi i)^n} \sum_{\nu=1}^n \frac{(-1)^{\nu-1} \bar{z}^{k_\nu+1}}{\langle z, \bar{z}^{k+1} \rangle} d\bar{z}^{k+1}[\nu] \wedge dz,$$

then for any function  $f \in \mathcal{O}(\bar{D})$  at points  $z \in D$  we have

$$\frac{d^k f(z)}{dz^k} = \int_{\partial D} f(\zeta) \omega_k(\zeta - z)$$

(the ANDREOTTI-NORGUET formula, a higher-dimensional analogue of the Cauchy formula for derivatives).

3. Let  $\bar{\Pi} = \{z \in \mathbb{C}^n : |p_\mu(z)| \leq 1, \mu = 1, \dots, n\}$  be a polynomial polyhedron in  $\mathbb{C}^n$  such that  $\det\left(\frac{\partial p_\mu}{\partial z_\nu}\right) \neq 0$  on its skeleton  $\Gamma$ . Prove that every function  $f \in \mathcal{O}(\Gamma) \cap C(\Pi \cup \Gamma)$  is uniformly approximated by polynomials (and thus, in particular, extends to a function from  $C(\bar{\Pi})$ ).

4. Let  $S \subset \mathbb{C}^m$  be a smooth real hypersurface and let  $f: S \rightarrow \mathbb{C}^n$  be a smooth mapping. Prove that the graph  $\{(z, f(z)) : z \in S\}$  is a maximally complex manifold if and only if the coordinates of  $f$  are CR-functions.

5. Let  $M = \{z \in \mathbb{C}^n : \varphi_1(z) = \dots = \varphi_k(z) = 0\}$  be a generating manifold and  $\varphi_j$  defining functions. Prove that  $f \in C^1(M)$  is a CR-function on  $M$  if and only if  $\bar{\partial} f \wedge \bar{\partial} \varphi_1 \wedge \dots \wedge \bar{\partial} \varphi_k = 0$  on  $M$ .

6. Let  $f$  be holomorphic in a polydisc  $U \subset \mathbb{C}^n$  and continuous on the set  $U \cup \Gamma$ , where  $\Gamma$  is the skeleton of  $U$ . Prove that  $f$  extends to a function from  $C(\bar{U})$ .

7. A function  $f$  is continuous on the boundary  $\partial U$  of the unit polydisc  $U \subset \mathbb{C}^n$ , and in each disc  $\Delta_{\nu, \alpha} = \{\zeta : \zeta_\mu = e^{i\alpha_\mu}, \mu \neq \nu, |\zeta_\nu| < 1\} \subset \partial U$  it is holomorphic with respect to  $\zeta_\nu$ ,  $\nu = 1, 2, \dots, n$ . Prove that  $f$  extends to a function from  $\mathcal{O}(U) \cap C(\bar{U})$ .

8. A function  $f$  is continuous on the skeleton  $\Gamma$  of the unit polydisc  $U \subset \mathbb{C}^n$ . Prove that  $f$  extends to a function from  $\mathcal{O}(U) \cap C(\bar{U})$  if and only if  $\int_\Gamma f(\zeta) \zeta^k d\zeta = 0$  for all  $k = (k_1, \dots, k_n)$ , where  $k_\nu$  are integers and at least one of them is  $\geq 0$ .

9. Suppose that the function  $f$  is analytic in a domain  $D \subset \mathbb{R}^{2n}$  with respect to each coordinate  $x_1, \dots, x_{2n}$ , and that in some ball  $V \subset D$  it is holomorphic with respect to the complex coordinates  $z_\nu = x_\nu + ix_{\nu+n}$ ,  $\nu = 1, \dots, n$ . Prove that  $f$  is holomorphic in  $D$  (with respect to the coordinates  $z_\nu$ ).

10. Prove that the generalized unit disc (see subsection 10) is a convex domain.

11. Prove that the polynomially convex hull of a connected compact set is also connected.

12. Prove that the following sets are polynomially convex:

(a) the polynomial polyhedron of Weil;

(b) any compact set lying in a real subspace of  $\mathbb{C}^n$ ;

(c) the image  $G = f(\mathbb{C}^2)$  of  $\mathbb{C}^2$  under the mapping from Fatou's example (subsection 11).

13. Prove that the domain of convergence of a series in polynomials (respectively, rational functions) is polynomially (resp. rationally) convex.

14. Prove that the rationally convex hull  $\widehat{K}_R$  of a compact set  $K \subset \mathbb{C}^n$  coincides with the set  $\{z \in \mathbb{C}^n : p(z) \in p(K) \text{ for all polynomials } p\}$ .

15. Prove that the polynomially convex hull of the set  $M \subset \mathbb{C}^2$ , consisting of a circle without a small arc  $\{z_1 = e^{it}, \delta \leq t \leq 2\pi; z_2 = 0\}$  and a cylinder  $\{z_1 = e^{it}, 0 \leq t \leq \delta; |z_2| = 1\}$ , contains the disc  $\{|z_1| \leq 1, z_2 = 0\}$ .

16. Prove that the domain  $D = \{z \in \mathbb{C}^2 : |z_1|^2 + x_2^2 \geq \rho^2\}$  is not a domain of holomorphy.

17. Let  $D$  be a domain of holomorphy and  $M$  an analytic set in  $D$ . Prove that then for any compact subset  $K \subset M$  its hull relative to  $\mathcal{O}(D)$  belongs to  $M$ .

18. Prove that the compact set  $K = \{|z_1| \leq 1, |z_2| \leq |z_1|\}$  cannot be represented as the limit of a decreasing sequence of domains of holomorphy.

19. Prove that a totally real manifold  $M \subset \mathbb{C}^n$  of class  $C^2$  is a limit of some decreasing sequence of domains of holomorphy.

20. Prove that for real functions  $\varphi \in C^2$  the so-called *Levi determinant*

$$-\begin{vmatrix} 0 & \frac{\partial \varphi}{\partial \bar{z}_k} \\ \frac{\partial \varphi}{\partial z_j} & \frac{\partial^2 \varphi}{\partial z_j \partial \bar{z}_k} \end{vmatrix}$$

is equal to  $|\nabla \varphi|^2$  times the product of the eigenvalues of the restriction of  $H_z(\varphi, \omega)$  to  $T_z^c(\{\varphi = 0\})$ .

21. Prove the following strengthening of Theorem 2 from subsection 37: if a domain  $D$  is strictly pseudoconvex at a point  $0 \in \partial D$ , then by a biholomorphic change of coordinates in a neighborhood of this point its defining function can be reduced to the form  $\varphi(z) = \operatorname{Re} z_n + |z|^2 + o(|z|^2)$ .

22. Prove that domains  $D$  at a point  $a \in \partial D$  of strict pseudoconvexity of  $D$  can be strictly tangent from the exterior by a level set of a holomorphic function  $f$ , i.e., so that  $\{f = 0\} \cap \partial D = \{a\}$ .

23. Prove that a domain  $D \subset \mathbb{C}^n$  is pseudoconvex if and only if, for any holomorphic disc  $S \subset D$ , the distance  $\delta(S, \partial D) = \delta(\partial S, \partial D)$ .

24. Suppose that a domain  $D \subset \mathbb{C}^n$  with a  $C^2$  boundary is contained in a ball  $B$ ; prove that  $D$  is strictly pseudoconvex at all boundary points at which it is tangent to  $\partial B$ .

25. Prove that the domain  $D = \{z \in \mathbb{C}^n : |z| < 1, z_n \neq 0\}$  is a pseudoconvex domain, which cannot be given as the set of negative values of a plurisubharmonic function. [HINT: use the Grauert-Remmert theorem cited at the end of subsection 38 and the maximum principle.]

26. The definition of subharmonicity carries over without any changes to the case of the space  $\mathbb{R}^m$  if the majorant is assumed to be a harmonic function of  $m$  real variables. Prove that the plurisubharmonic functions in a domain  $D \subset \mathbb{C}^n (= \mathbb{R}^{2n})$  form a subclass of the functions that are subharmonic in  $D$ .

27. Prove that every function that is harmonic in a domain  $D \subset \mathbb{C}^n$  and plurisubharmonic in some ball  $B \subset D$  is pluriharmonic in  $D$ .

28. The polynomially convex hull of a compact subset  $K \subset \mathbb{C}^n$  coincides with the set  $\{z \in \mathbb{C}^n : u(z) \leq \sup_K u \text{ for all functions } u \text{ that are plurisubharmonic in } \mathbb{C}^n\}$ .

## CHAPTER IV

# Meromorphic Functions and Residues

In this chapter we shall consider the class of functions with the simplest type of singularities—meromorphic functions. Most of our attention will be devoted to the solution of the Cousin problems, which consist in the construction of meromorphic functions from given principal parts and zeros. First we consider the elementary solution of these problems in the simplest case, and then we will acquaint the readers with methods that lead to the general solution of these problems. The last section is devoted to the theory of higher-dimensional residues and related problems of analysis.

### §15. Meromorphic functions

**43. The concept of a meromorphic function.** A function  $f$  is said to be *meromorphic* in a domain  $D \subset \mathbb{C}^n$  if: (1) it is holomorphic everywhere in  $D$  except for some set  $P$ ; (2) it cannot be analytically continued to any point of  $P$ ; and (3) for any point  $z^0 \in P$  there exist a neighborhood  $U$  and a holomorphic function  $\psi \neq 0$  in  $U$  such that the holomorphic function  $\varphi = f\psi$  in  $D \cap \{U \setminus P\}$  extends holomorphically into  $U$ .

It is obvious that  $\psi(z^0) = 0$  at each point  $z^0 \in P \cap U$  (otherwise besides  $f\psi$  the function  $f$  could also be continued to some neighborhood of the point  $z^0$ ). If we assume that for any  $z^0 \in P$  the functions  $\varphi$  and  $\psi$  do not have common factors that are holomorphic in some neighborhood of  $z^0$  and equal to zero at  $z^0$  (it is always possible to cancel such factors from  $\varphi$  and  $\psi$ ), then  $\psi$  will vanish only on the set  $P$ . Thus,  $P$  is an analytic set: in a neighborhood  $U_{z^0}$  of an arbitrary point of  $P$  it is defined by the condition

$$P = \{z \in U_{z^0} : \psi(z) = 0\}, \quad (1)$$

where  $\psi \in \mathcal{O}(U_{z^0})$ . The set  $P$  is called the *polar set of the function  $f$* .

However, the behavior of a meromorphic function  $f$  is not the same at all points of the polar set  $P$ . The points  $z^0 \in P$  are separated into *poles*, at which the function  $\varphi = f\psi$  is nonzero, and *points of indeterminacy*, at which  $\varphi = 0$  (as before we assume that  $\varphi$  and  $\psi$  do not have common factors that are holomorphic at  $z^0$  and equal to zero there). As a pole

is being approached, the function  $f = \varphi/\psi$  grows unboundedly, and in a neighborhood of a point of indeterminacy this function can take any complex value (namely, the value of  $w_0$  on the analytic set  $\{z \in U_{z_0} : \varphi(z) - w_0\psi(z) = 0\}$ , which obviously contains the point of indeterminacy  $z^0$ . The complex dimension of the set of points of indeterminacy is at least one less than the dimension of the set of poles, since points of indeterminacy are characterized by the additional condition  $\varphi(z) = 0$ , which is independent of  $\psi(z) = 0$ .

EXAMPLE. For the function  $f = z_2/z_1$ , which is meromorphic in  $\mathbb{C}^2$ , the polar set is the complex line  $\{z_1 = 0\}$ . All the points of this line are poles, except  $\{z_1 = 0, z_2 = 0\}$ , which is a point of indeterminacy.

We shall now give the general definition of a meromorphic function on an arbitrary complex manifold  $M$ ; it is convenient to formulate it using the concept of a sheaf (subsection 28). For a fixed point  $p \in M$  we define the stalk  $\mathcal{M}_p$  as the field of quotients of the ring  $\mathcal{O}_p$  of germs of holomorphic functions at the point  $p$ . We mean the following by this: two pairs  $(\varphi, \psi)$  and  $(\varphi_1, \psi_1)$  of germs belonging to  $\mathcal{O}_p$ , where  $\psi$  and  $\psi_1$  are not germs of functions that are identically equal to zero, are said to be *equivalent* if  $\varphi\psi_1 = \psi\varphi_1$  (the check that the axiom of equivalence is satisfied is elementary). The equivalence classes modulo this relation are called *germs of meromorphic functions* at the point  $p$ ; the germ containing the pair  $(\varphi, \psi)$  will be denoted by the symbol  $\mathbf{f} = \varphi/\psi$ . The operations

$$\frac{\varphi_1}{\psi_1} + \frac{\varphi_2}{\psi_2} = \frac{\varphi_1\psi_2 + \varphi_2\psi_1}{\psi_1\psi_2}, \quad \frac{\varphi_1}{\psi_1} \cdot \frac{\varphi_2}{\psi_2} = \frac{\varphi_1\varphi_2}{\psi_1\psi_2} \tag{2}$$

are defined in the set  $\mathcal{M}_p$  of all such germs, where on the right-hand sides operations on germs of holomorphic functions are used (see subsection 29 of Part I); it is not hard to see that the operations in (2) are well defined (first, the equivalence classes of the pairs in the right-hand sides belong to  $\mathcal{M}_p$ , since  $\psi_1\psi_2 \neq 0$  if  $\psi_1 \neq 0$  and  $\psi_2 \neq 0$ , and second, they do not depend on the choice of representatives of the classes). With respect to these operations  $\mathcal{M}_p$  is a commutative field, and it is called the *field of quotients* of the ring  $\mathcal{O}_p$ .

The identity element of the additive group of the field  $\mathcal{M}_p$  is the element  $\mathbf{0} = \mathbf{0}/\psi$ , where  $\psi \neq \mathbf{0}$ ; it can be identified with the germ of the holomorphic function that is identically zero. The set  $\mathcal{M}_p^* = \mathcal{M}_p \setminus \mathbf{0}$  of germs of meromorphic functions that are not identically zero forms the multiplicative group of the field  $\mathcal{M}_p$ . Its identity element is  $\mathbf{1} = \varphi/\varphi$ , where  $\varphi \neq \mathbf{0}$ , and the inverse to the element  $\mathbf{f} = \varphi/\psi$  is  $\mathbf{1}/\mathbf{f} = \psi/\varphi$  (it belongs to  $\mathcal{M}_p$  since  $\varphi \neq \mathbf{0}$ ).

We can now introduce the *sheaf of germs of meromorphic functions* on a complex manifold  $M$  as the sheaf of fields whose underlying space is

$$\mathcal{M}(M) = \bigcup_{p \in M} \mathcal{M}_p, \tag{3}$$

and the projection and topology are introduced as for the sheaf  $\mathcal{O}(M)$ ; the

operations (2) are continuous in this topology. The sections of the sheaf  $\mathcal{M}(M)$  in a domain  $D \subset M$  are called *meromorphic functions* in this domain; the set of them is denoted by the symbol  $\Gamma(D, \mathcal{M})$  or simply  $\mathcal{M}(D)$ .

The points of a domain  $D$  can be partitioned into two types with respect to a meromorphic function  $f \in \mathcal{M}(D)$ . We say that the function  $f$  is *determinate* at a point  $p \in D$  if  $f$  associates to  $p$  a germ  $\mathbf{f} \in \mathcal{M}_p$  of which  $(\varphi, \psi)$  is a representative, where  $\varphi, \psi \in \mathcal{O}_p$  and they do not vanish simultaneously at  $p$ .<sup>(1)</sup> To each point  $p$  at which the function  $f$  is determinate, it assigns the value  $f(p) = \varphi(p)/\psi(p)$ , which is finite if  $\psi(p) \neq 0$ , and infinite if  $\psi(p) = 0$  (this value obviously does not depend on the choice of representative  $(\varphi, \psi)$  of the germ  $\mathbf{f}$ ). The points of  $D$  at which the meromorphic function  $f \in \mathcal{M}(D)$  is not determinate form the *set of indeterminacy* of  $f$ . These are the points  $p$  corresponding to a germ  $\mathbf{f} \in \mathcal{M}_p$  for all representatives  $(\varphi, \psi)$  of which we simultaneously have  $\varphi(p) = \psi(p) = 0$ .

The points of  $D$  at which a function  $f \in \mathcal{M}(D)$  is determinate form an open dense subset of  $D$ , since its complement, the set of points of indeterminacy of  $f$ , is an analytic set. In the same way the set of points of  $D$  at which  $f$  is determinate and takes finite values is open and dense. To the points of this set correspond germs  $\mathbf{f} \in \mathcal{M}$  which can be represented in the form  $\varphi/1$  and can be identified with the germs  $\varphi \in \mathcal{O}$ , so that this set is called the *set of holomorphy* of the function  $f$ . Its complement in  $D$  is called the *polar set* of  $f$  (it consists of the points of indeterminacy of  $f$  and those points where  $f$  is determinate and takes infinite values).

As an example we consider meromorphic functions on  $\overline{\mathbb{C}}^n$  and  $\mathbb{P}^n$ . In  $\overline{\mathbb{C}}^n$  all the polynomials and rational functions of  $z = (z_1, \dots, z_n)$  are meromorphic functions.

**EXAMPLE.** The set of points of infinity of  $\overline{\mathbb{C}}^2$  is the polar set of the function  $z_1 z_2$ , and on this set  $(0, \infty)$  and  $(\infty, 0)$  are points of indeterminacy. The polar set of the function  $z_1 z_2 / (z_1 + z_2)$  is the line  $\{z_2 = -z_1\}$ ; the points of indeterminacy are  $(0, 0)$  and  $(\infty, \infty)$  and the remaining infinite points are points of holomorphy.

In  $\mathbb{P}^n$  the polynomials of  $z = (z_0, \dots, z_n)$  are not functions (if they are not constants), and among the rational functions only those homogeneous functions are admitted that are invariant when  $z$  is replaced by  $\lambda z$ ,  $\lambda \in \mathbb{C}_*$  (i.e., quotients of homogeneous polynomials); the latter are meromorphic in  $\mathbb{C}\mathbb{P}^n$ . It turns out that the rational functions exhaust the meromorphic functions in these spaces.

**THEOREM 1.** *Any function  $f$  that is meromorphic in  $\mathbb{P}^n$  or  $\overline{\mathbb{C}}^n$  is rational.*

◀ The affine part of both these space is  $\mathbb{C}^n$ , and if  $z = (z_1, \dots, z_n)$  are coordinates in  $\mathbb{C}^n$ , then the restriction of  $f$  to any complex line  $\mathbb{C} = \{z_\nu\}$  with the other coordinates being fixed is a meromorphic function of the single variable  $z_\nu$ , which has a pole or a removable point at the point  $z_\nu = \infty$

<sup>(1)</sup>The value of a germ of a holomorphic function at a point is understood to be the value of functions representing it at this point.

( $\nu = 1, \dots, n$ ). By the theorem of subsection 25 of Part I this restriction is a rational function of  $z_\nu$ . But a function that is rational with respect to each variable when the other variables are fixed is also rational with respect to the set of all the variables (see Problem 10 of Chapter I). By the uniqueness theorem  $f$  is also rational on the whole space  $\mathbb{P}^n$  or  $\overline{\mathbb{C}}^n$ . ►

We turn our attention to the concept of a divisor of a meromorphic function. For functions of one variable the divisor is the set of zeros and poles of the functions together with their orders, where the orders of zeros are considered to be positive while the orders of poles are considered to be negative. Passing to the general case, we assume that a meromorphic function  $f$  is given on an  $n$ -dimensional complex manifold  $M$ . Suppose that locally, in a neighborhood  $U$  of a point  $p_0 \in M$ , it is represented as a quotient of functions that are holomorphic in  $U$ :

$$f(p) = \frac{\varphi(p)}{\psi(p)}, \quad (4)$$

where  $\varphi$  and  $\psi$  do not have common holomorphic factors that simultaneously vanish (such a representation is termed “reduced”). We denote by  $A$  the union of the set  $N$  of zeros of this function and its polar set  $P$ ; this is obviously an analytic set of codimension 1 (or empty). The points of indeterminacy, i.e., the points of  $N \cap P$ , are critical points of  $A$ , so that any regular point  $a \in A^0$  belongs either to  $N$  or to  $P$  (see subsection 24). Furthermore, such a point can belong to only one irreducible component of  $N$  or  $P$  (since the points of intersection of several components are critical points), and hence, to it there corresponds a completely determined natural number—the exponent of the degree of the corresponding factor in the decomposition of  $\varphi$  or  $\psi$  into irreducible factors (see subsection 24). We shall make a convention to take this number with the sign  $+$  if  $a \in N$ , and with the sign  $-$  if  $a \in P$ , and call it the *order* of the component. It obviously does not depend on the choice of the reduced local representation (4).

The *divisor of a meromorphic function*  $f$  is the pair

$$\Delta_f = (A, k), \quad (5)$$

consisting of an analytic set  $A = N \cup P$  of codimension 1 and an integer function  $k = k(p)$ , which is defined on the set  $A^0$  of regular points of  $A$  and takes a constant value on each of its irreducible components, equal to the order of this component; the function  $k$  is continuous on  $A^0$ .

**44. The first Cousin problem.** We start by rephrasing the problem on the construction of a meromorphic function of one variable from its poles and principal parts (subsection 45 of Part I). Suppose that in a domain  $D \subset \mathbb{C}$  we are given a sequence of points  $a_\nu$ , not having limit points in  $D$ , and a sequence of functions  $g_\nu(z) = \sum_{k=1}^{n_\nu} c_k^{(\nu)} / (z - a_\nu)^k$ . Consider a covering  $\mathcal{U} = \{U_\alpha\}_{\alpha \in A}$  of the domain  $D$  by domains  $U_\alpha \subset D$ , each of which contains

a finite number of the points  $a_\nu$ , and denote by  $f_\alpha$  the sum of the  $g_\nu$  corresponding to all the points  $a_\nu \in U_\alpha$ ; if  $U_\alpha$  does not contain any of the points  $a_\nu$ , we set  $f_\alpha \equiv 0$ . All the  $f_\alpha$  are meromorphic functions, and, if  $U_\alpha \cap U_\beta \neq \emptyset$ , then  $f_\alpha - f_\beta = h_{\alpha\beta}$  is a holomorphic function in this intersection. The problem is reduced to the construction of a meromorphic function  $f$  in the whole domain  $D$  such that the differences  $f - f_\alpha$  are holomorphic in  $U_\alpha$  for all  $\alpha \in A$ . By the Mittag-Leffler theorem (subsection 45 of Part I) this problem is solvable for any domain  $D$  of the plane.

In this form the problem can be posed for an arbitrary complex manifold  $M$ , and it is called the *first* or *additive Cousin problem* for a covering.

In what follows a *covering* of a manifold  $M$  will be a set  $\mathcal{U} = \{U_\alpha\}_{\alpha \in A}$  of open subsets  $U_\alpha$  of  $M$  such that  $\bigcup U_\alpha = M$  and each point  $p \in M$  belongs to a finite number of the  $U_\alpha$  (the condition of LOCAL FINITENESS). The statement of the problem is as follows:

Given a covering  $\mathcal{U} = \{U_\alpha\}_{\alpha \in A}$  of a complex manifold  $M$  and a meromorphic function  $f_\alpha$  in each  $U_\alpha$ , where the following COMPATIBILITY CONDITION holds: in any nonempty intersection  $U_{\alpha\beta} = U_\alpha \cap U_\beta$  the difference

$$f_\alpha - f_\beta = h_{\alpha\beta} \in \mathcal{O}(U_{\alpha\beta}), \quad (1)$$

i.e., is a holomorphic function, the problem is to construct a meromorphic function  $f$  on the whole manifold  $M$  such that  $f - f_\alpha \in \mathcal{O}(U_\alpha)$  for all  $\alpha \in A$ .

For dimensions greater than 1 this problem is not always solvable.

EXAMPLE. Suppose that the domain  $\mathbb{C}_*^2 = \mathbb{C}^2 \setminus \{0\}$  is covered by two domains  $U_j = \mathbb{C}^2 \setminus \{z_j = 0\}$ ,  $j = 1, 2$ . We take the function  $1/(z_1 z_2)$ , which is meromorphic in  $U_1$ , as  $f_1$  and in  $U_2$  we set  $f_2 \equiv 0$ ; since  $U_{12} = \mathbb{C}^2 \setminus \{z_1 z_2 = 0\}$ , these Cousin data are compatible. Assume that this Cousin problem is solvable, i.e., there exists a meromorphic function  $f$  in  $\mathbb{C}_*^2$  such that  $f - f_1 = g_1 \in \mathcal{O}(U_1)$  and  $f \in \mathcal{O}(U_2)$ . Since  $z_2 f_1 = 1/z_1 \in \mathcal{O}(U_1)$ , then  $z_2 f \in \mathcal{O}(U_1)$ , and hence, the function  $z_2 f$  is holomorphic in  $U_1 \cup U_2 = \mathbb{C}_*^2$ . By the theorem on compact singularities  $z_2 f$  extends to an entire function, and  $1/z_1 = z_2 f - z_2 g_1$  in  $U_1$ ; in particular,  $1/z_1 = z_2 f$  in the punctured plane  $\{z_2 = 0\} \setminus 0$ . But the function  $z_2 f$  is continuous at 0, while  $1/z_1$  is unbounded. This is a contradiction.

We shall give a necessary and sufficient condition for Cousin's problem to be solvable, which, however, is so close to the problem itself that it can be considered as a variant formulation.

The functions  $h_{\alpha\beta} = f_\alpha - f_\beta$  are obviously skew-symmetric with respect to the indices, i.e.,  $h_{\beta\alpha} = -h_{\alpha\beta}$ , and in each triple intersection  $U_{\alpha\beta\gamma} = U_\alpha \cap U_\beta \cap U_\gamma \neq \emptyset$  they satisfy the condition

$$h_{\alpha\beta} + h_{\beta\gamma} + h_{\gamma\alpha} = 0. \quad (2)$$

Any collection of functions  $h_{\alpha\beta} \in \mathcal{O}(U_{\alpha\beta})$  that are skew-symmetric with respect to the indices and satisfy condition (2) in all triple intersections  $U_{\alpha\beta\gamma}$  will be called a *holomorphic cocycle* for a given covering  $\mathcal{U} = \{U_\alpha\}$  of the manifold.



If these functions are connected with the Cousin data by relation (1), then the cocycle  $\{h_{\alpha\beta}\}$  is said to *correspond* to the Cousin problem  $\{f_\alpha\}$ . Finally, a holomorphic cocycle  $\{h_{\alpha\beta}\}$  is called a *coboundary* if, for all  $\alpha \in A$ , there exist functions  $h_\alpha \in \mathcal{O}(U_\alpha)$  such that in each intersection  $U_{\alpha\beta}$  we have

$$h_{\alpha\beta} = h_\beta - h_\alpha. \quad (3)$$

These terms also allow us to formulate the solvability condition that we mentioned above:

**THEOREM 1.** *For the Cousin problem  $\{f_\alpha\}$  to be solvable for a given covering  $\mathcal{U}$  of the manifold  $M$  it is necessary and sufficient that the holomorphic cocycle  $\{h_{\alpha\beta}\}$  corresponding to this problem be a coboundary.*

◀ If the Cousin problem  $\{f_\alpha\}$  is solvable, then there exists a function  $f$  that is meromorphic on  $M$  and such that all the differences  $f - f_\alpha = h_\alpha$  are holomorphic in  $U_\alpha$  ( $\alpha \in A$ ). Hence for the corresponding holomorphic cocycle  $h_{\alpha\beta}$  we have

$$h_{\alpha\beta} = f_\alpha - f_\beta = h_\beta - h_\alpha,$$

and this means that  $\{h_{\alpha\beta}\}$  is cohomologous to zero.

Conversely, suppose that the holomorphic cocycle  $\{h_{\alpha\beta}\}$  corresponding to the Cousin problem  $\{f_\alpha\}$  is a coboundary. Then there exist functions  $h_\alpha \in \mathcal{O}(U_\alpha)$  such that  $h_\beta - h_\alpha = h_{\alpha\beta}$  in each intersection  $U_{\alpha\beta}$ , i.e., in each  $U_{\alpha\beta}$  we have  $f_\alpha - f_\beta = h_\beta - h_\alpha$  or

$$f_\alpha + h_\alpha = f_\beta + h_\beta$$

for any  $\alpha, \beta \in A$ . Thus, the functions  $f_\alpha + h_\alpha$ , meromorphic in  $U_\alpha$ , do not depend on the choice of the neighborhood  $U_\alpha$ , and on all of  $M$  there is a globally defined meromorphic function  $f$ , equal to  $f_\alpha + h_\alpha$  in each  $U_\alpha$ . This function solves the Cousin problem under consideration. ▶

We rephrase this theorem. For a given covering  $\{U_\alpha\}$  of the manifold  $M$  the holomorphic cocycles  $h_{\alpha\beta}$  can be added together (pointwise in each intersection  $U_{\alpha\beta}$ ) and relative to this operation they form a group, which we denote by  $Z^1(\mathcal{U}, \mathcal{O})$  and call the *group of holomorphic cocycles* for the given covering  $\mathcal{U}$ . In this group there is a subgroup  $B^1(\mathcal{U}, \mathcal{O})$  of coboundaries. The quotient-group

$$Z^1(\mathcal{U}, \mathcal{O})/B^1(\mathcal{U}, \mathcal{O}) = H^1(\mathcal{U}, \mathcal{O}) \quad (4)$$

is called the (first) *cohomology group* for the covering  $\mathcal{U}$  of the manifold  $M$  (with holomorphic coefficients).

The elements of  $H^1(\mathcal{U}, \mathcal{O})$  are the classes of cohomologous holomorphic cocycles. The triviality of this group means that for the covering under consideration all the holomorphic cocycles are coboundaries. Therefore Theorem 1 can be formulated as follows:

**THEOREM 1'.** *A necessary and sufficient condition for the solvability of any first Cousin problem for a covering  $\mathcal{U}$  of a complex manifold  $M$  is the triviality of the first cohomology group with holomorphic coefficients:*

$$H^1(\mathcal{U}, \mathcal{O}) = 0. \tag{5}$$

The concepts introduced above admit a direct analogue in the class of smooth (infinitely differentiable) functions and manifolds. Suppose that a smooth manifold  $M$  is covered by a system  $\mathcal{U} = \{U_\alpha\}_{\alpha \in A}$  of open sets and suppose that to each nonempty intersection  $U_{\alpha\beta}$  there is an associated function  $h_{\alpha\beta} \in \mathcal{F}(U_{\alpha\beta})$ , i.e., a smooth function in  $U_{\alpha\beta}$ , such that  $h_{\beta\alpha} = -h_{\alpha\beta}$ . If condition (2) holds in every triple intersection, then  $\{h_{\alpha\beta}\}$  will be called a *smooth cocycle* for the covering  $\mathcal{U}$ . If the smooth analogue of condition (3) also holds, i.e., for any  $\alpha \in A$  there exists a function  $h_\alpha \in \mathcal{F}(U_\alpha)$  such that  $h_{\alpha\beta} = h_\beta - h_\alpha$  in  $U_{\alpha\beta}$  for all  $\alpha, \beta \in A$ , then the cocycle  $\{h_{\alpha\beta}\}$  is called a *coboundary*.

In the same way as in the holomorphic case, one can define the first cohomology group  $H^1(\mathcal{U}, \mathcal{F})$  with smooth coefficients. However, it turns out that the following theorem holds:

**THEOREM 2.** *For any covering  $\mathcal{U}$  of a smooth manifold  $M$  the first cohomology group with smooth coefficients is trivial:*

$$H^1(\mathcal{U}, \mathcal{F}) = 0. \tag{6}$$

◀ For  $\{U_\alpha\}$  we construct a partition of unity, i.e., a family of functions  $e_\alpha \in C^\infty(M)$  such that  $\sum_{\alpha \in A} e_\alpha(p) = 1$  for all points  $p \in M$  and the support of each  $e_\alpha$  is compactly contained in  $U_\alpha$ . Using this partition of unity we smooth the functions  $h_{\alpha\beta}$ , replacing them by the functions

$$h'_{i\alpha} = \begin{cases} e_i h_{i\alpha} & \text{in } U_{i\alpha}, \\ 0 & \text{in } U_\alpha \setminus U_{i\alpha}. \end{cases}$$

Here we have extended  $h_{i\alpha}$  to the entire neighborhood  $U_\alpha$ , but it turns out to be different from zero only in the intersection  $U_{i\alpha}$ . Now in each  $U_\alpha$  we can define the function

$$h_\alpha = \sum_i h'_{i\alpha}; \tag{7}$$

here the sum is taken over the whole set of indices, but only a finite number of terms is nonzero at each point  $p \in U_\alpha$ .

Obviously, all the  $h_\alpha \in C^\infty$  and at any point of each intersection  $U_{\alpha\beta}$  we have

$$h_\beta - h_\alpha = \sum_i (h'_{i\beta} - h'_{i\alpha}) = \sum_i e_i (h_{i\beta} - h_{i\alpha}). \tag{8}$$

But since  $\{h_{\alpha\beta}\}$  is a cocycle, then at each point of the intersection  $U_{\alpha\beta i}$  we have  $h_{i\beta} - h_{i\alpha} = h_{\alpha i} + h_{i\beta} = h_{\alpha\beta}$  in view of (2), and therefore by (8) in each

$U_{\alpha\beta}$  we have

$$h_\beta - h_\alpha = \sum_i e_i h_{\alpha\beta} = h_{\alpha\beta}.$$

Thus, the family  $\{h_\alpha\}$  is the desired one, i.e.,  $\{h_{\alpha\beta}\}$  is a coboundary. ►

The reader will certainly have noticed that the terms introduced here are analogous to those that were introduced in subsection 14 in the study of differential forms. In the following subsection we shall see that the connection between differential forms and the Cousin problem is rather profound and is not exhausted by the resemblance in terminology.

**45. Solution of the first problem.** Here we shall prove the solvability of the first Cousin problem in the simplest case of the polydisc, or, more generally, in a product of simply connected domains of the plane. The solution will be realized in two steps, the first of which has already been prepared, and the second requires the following preparatory lemma:

**LEMMA.** *In any simply connected domain  $D \subset \mathbb{C}$  for any function  $g \in C^\infty$  the inhomogeneous Cauchy-Riemann system*

$$\frac{\partial f}{\partial \bar{z}} = g(z) \tag{1}$$

*is solvable in the class  $C^\infty(D)$ . If  $g$  here is a holomorphic (or smooth) function of some parameter, then the solution  $f$  also depends holomorphically (or smoothly) on it.*

◀ Suppose first that the function  $g$  is compactly supported, i.e., is equal to zero outside some compact subset of  $D$ . By the Cauchy-Green formula (subsection 19 of Part I) we then have

$$g(z) = \frac{1}{2\pi i} \int_D \frac{\partial g}{\partial \bar{\zeta}} \frac{d\zeta \wedge d\bar{\zeta}}{\zeta - z}. \tag{2}$$

We now consider the function

$$f(z) = \frac{1}{2\pi i} \int_D \frac{g(\zeta) d\zeta \wedge d\bar{\zeta}}{\zeta - z}; \tag{3}$$

we can extend  $g$  to the whole plane, setting it equal to zero in  $\mathbb{C} \setminus D$ , and then we can assume that the integration is over  $\mathbb{C}$ . We also make a change of the variable of integration  $\zeta \rightarrow \zeta + z$ ; we will then have

$$f(z) = \frac{1}{2\pi i} \int_{\mathbb{C}} \frac{g(z + \zeta)}{\zeta} d\zeta \wedge d\bar{\zeta}. \tag{4}$$

Differentiating under the integral sign (which is obviously legal), we find

$$\frac{\partial f}{\partial \bar{z}} = \frac{1}{2\pi i} \int_{\mathbb{C}} \frac{\partial g}{\partial \bar{\zeta}} \frac{d\zeta \wedge d\bar{\zeta}}{\zeta}$$

or, returning to the old integration variable,

$$\frac{\partial f}{\partial \bar{z}} = \frac{1}{2\pi i} \int_{\mathbb{C}} \frac{\partial g}{\partial \bar{\zeta}} \frac{d\zeta \wedge d\bar{\zeta}}{\zeta - z}.$$

Comparing this with (2) we see that  $f$  satisfies the system (1). We can differentiate the integral (4) as many times as we please with respect to  $z$ , and hence  $f \in C^\infty(D)$ . If  $g$  depends holomorphically on a parameter, then the integral also depends on it the same way. This proves the lemma for compactly supported  $g$ .

In the general case we take a compact exhaustion of  $D$  by simply connected domains  $G_\nu$  ( $G_\nu \subset\subset G_{\nu+1}$ ,  $\bigcup G_\nu = D$ ) and we construct functions  $g_\nu \in C^\infty(D)$  such that  $g_\nu = g$  in  $G_\nu$  and  $g_\nu = 0$  in  $D \setminus G_{\nu+1}$ . By what we have already proved each system  $\partial f / \partial \bar{z} = g_\nu$  is solvable in the class  $C^\infty(D)$ ; we shall now prove that the solutions  $f_\nu$  can be chosen so that in each  $G_\nu$  we have

$$|f_{\nu+1} - f_\nu| < 1/2^\nu, \quad \nu = 1, 2, \dots \quad (5)$$

In fact, we choose a solution  $f_1$  according to formula (3), in which  $g$  is replaced by the function  $g_1$ , then we take  $\tilde{f}_2$  according to the same formula with the change  $g = g_2$  and note that the difference  $\tilde{f}_2 - f_1$  is holomorphic in  $G_1$  (since there  $\frac{\partial}{\partial \bar{z}}(\tilde{f}_2 - f_1) = g_2 - g_1 = 0$ ). By Runge's theorem (subsection 23 of Part I) for any domain  $G_0 \subset\subset G_1$  we can choose a polynomial  $P_1$  such that in  $G_0$  we will have

$$|\tilde{f}_2 - f_1 - P_1| < 1/2;$$

we now see that  $f_2 = \tilde{f}_2 - P_1$  satisfies the system  $\partial f / \partial \bar{z} = g_2$  and condition (5) for  $\nu = 1$ . Precisely the same method can also be applied for  $\nu = 2, 3, \dots$ .

The sequence  $f_\nu$  thus constructed converges uniformly on each compact subset  $K \subset\subset D$  to the function

$$f = f_1 + \sum_{\nu=1}^{\infty} (f_{\nu+1} - f_\nu).$$

In any  $G_\mu$  the function  $f$  is represented as a finite sum of  $C^\infty$  functions and the sum of a uniformly convergent series of holomorphic functions  $f_{\nu+1} - f_\nu$ , where  $\nu \geq \mu$  (for  $\nu \geq \mu$  we have  $\partial f_{\nu+1} / \partial \bar{z} = \partial f_\nu / \partial \bar{z} = g$  on  $G_\mu$ ). Consequently,  $f \in C^\infty(D)$  and  $\partial f / \partial \bar{z} = \lim_{\nu \rightarrow \infty} (\partial f_\nu / \partial \bar{z}) = g$  everywhere in  $D$ ; the holomorphic dependence of  $f$  on the parameter on which  $g$  depends follows from Weierstrass's theorem (subsection 23 of Part I), and the proof in the smooth case is elementary. ►

The basis of the second step of the solution of the Cousin problem is the so-called theorem on the solvability of the  $\bar{\partial}$ -problem. In order to state it we recall that every form  $\omega$  that is exact relative to the operator  $\bar{\partial}$  (i.e., a form which can be represented in the form  $\omega = \bar{\partial}\omega_1$ ) is also closed, i.e.,  $\bar{\partial}\omega = 0$ ; this follows from the relation  $\bar{\partial}^2 = 0$  (see subsection 15). Thus, the condition of being closed is necessary for a form to be exact. The theorem on the solvability of the  $\bar{\partial}$ -problem asserts that for some domains this condition is also sufficient.

**THEOREM 1.** *If the domain  $D \subset \mathbb{C}^n$  is a polydisc, or, more generally, a product of simply connected domains of the plane  $D_1 \times \cdots \times D_n$ , then in  $D$  every  $\bar{\partial}$ -closed form  $\omega$  of bidegree  $(0, 1)$  with smooth coefficients is exact, i.e., any equation*

$$\bar{\partial}f = \omega, \quad (6)$$

where  $\omega = \sum_{\nu=1}^n a_\nu d\bar{z}_\nu$ ,  $a_\nu \in C^\infty(D)$ , and  $\bar{\partial}\omega = 0$ , is solvable in the class of functions  $f \in C^\infty(D)$ .

◀ We rewrite (6) as a system

$$\frac{\partial f}{\partial \bar{z}_\nu} = a_\nu, \quad \nu = 1, \dots, n, \quad (7)$$

and we shall prove its solvability in the class  $C^\infty(D)$  by induction on  $n$ . For  $n = 1$  the assertion is proved by the lemma; assume that it holds when the number of variables does not exceed  $n - 1$ , and we shall prove that it holds for the system (7) with  $n$  variables.

Consider the last equation of the system

$$\frac{\partial f}{\partial \bar{z}_n} = a_n$$

and denote its solution in the domain  $D_n$  by  $g$ , a function of  $z_n$  depending on  $'z = (z_1, \dots, z_{n-1})$  as a parameter. We look for a solution of (7) in the form  $f = g + \varphi$ , where  $\varphi$  is to be holomorphic with respect to  $z_n$  in  $D_n$ , and with respect to the remaining variables in the domain  $'D = D_1 \times \cdots \times D_{n-1}$  it must satisfy the system

$$\frac{\partial \varphi}{\partial \bar{z}_\nu} = a_\nu - \frac{\partial g}{\partial \bar{z}_\nu} \equiv b_\nu, \quad \nu = 1, \dots, n-1. \quad (8)$$

Since  $\omega$  is a closed form, i.e.,  $\partial a_\mu / \partial \bar{z}_\nu = \partial a_\nu / \partial \bar{z}_\mu$  and  $\partial^2 g / \partial \bar{z}_\mu \partial \bar{z}_\nu = \partial^2 g / \partial \bar{z}_\nu \partial \bar{z}_\mu$ , then  $\partial b_\mu / \partial \bar{z}_\nu = \partial b_\nu / \partial \bar{z}_\mu$  for all  $\mu, \nu = 1, \dots, n-1$ . Consequently, the form  $\sum_{\nu=1}^{n-1} b_\nu d\bar{z}_\nu$  is also closed and, by the induction hypothesis, there exists a solution  $\varphi \in C^\infty('D)$  of the system (8), depending on  $z_n$  as a parameter. It remains to check that  $\varphi$  depends holomorphically on  $z_n$ , and for this it suffices to see that the right-hand sides of (8) depend holomorphically on  $z_n$ .<sup>(2)</sup> But

$$\frac{\partial b_\nu}{\partial \bar{z}_n} = \frac{\partial a_\nu}{\partial \bar{z}_n} - \frac{\partial^2 g}{\partial \bar{z}_n \partial \bar{z}_\nu} = \frac{\partial a_\nu}{\partial \bar{z}_n} - \frac{\partial a_n}{\partial \bar{z}_\nu} = 0$$

for all  $\nu = 1, \dots, n-1$  since  $\omega$  is closed. ▶

We denote by

$$\tilde{H}^1(D) = Z^{0,1} / B^{0,1} \quad (9)$$

<sup>(2)</sup>This assertion is proved by induction on  $n$  using the lemma.

the quotient group of the group  $Z^{0,1}$  of  $\bar{\partial}$ -closed forms of bidegree  $(0, 1)$  with smooth coefficients in  $D$  modulo the subgroup  $B^{0,1}$  of exact  $(0, 1)$ -forms (cf. subsection 15, where the analogous group is defined for the operator  $d$ ). Then Theorem 1 can be reformulated as:

**THEOREM 1'.** *For a product  $D$  of simply connected planar domains the quotient group (9) is trivial.*

Everything is now ready to prove the solvability of the Cousin problem.

**THEOREM 2.** *If a domain  $D \subset \mathbb{C}^n$  is a product of simply connected planar domains, then for any covering  $\{U_\alpha\}$  of it any additive Cousin problem  $\{f_\alpha\}$  is solvable.*

◀ As we said, the proof is carried out in two stages. Let  $h_{\alpha\beta} = f_\alpha - f_\beta$  be the holomorphic cocycle corresponding to the problem (i.e., the set of functions holomorphic in the intersections  $U_{\alpha\beta} = U_\alpha \cap U_\beta$  of domains of the covering). First, using Theorem 2 of the previous subsection, we resolve this cocycle into smooth functions, i.e., we find functions  $g_\alpha \in C^\infty(U_\alpha)$  such that

$$h_{\alpha\beta} = g_\beta - g_\alpha \quad \text{in } U_{\alpha\beta}. \quad (10)$$

In the second stage we correct this solution, replacing the  $g_\alpha$  by holomorphic functions. For this we note that since the functions  $h_{\alpha\beta}$  are holomorphic in each intersection  $U_{\alpha\beta}$  we have  $\bar{\partial}h_{\alpha\beta} = \bar{\partial}g_\beta - \bar{\partial}g_\alpha = 0$ . From this we see that the form  $\omega$  of bidegree  $(0, 1)$  that is equal to  $\bar{\partial}g_\alpha$  in each  $U_\alpha$  is in fact globally defined in the whole domain  $D$  (in each intersection we have  $\bar{\partial}g_\alpha = \bar{\partial}g_\beta$ ). This form is obviously closed in  $D$  (since each point  $z \in D$  along with some neighborhood of it belongs to some  $U_\alpha$ , and  $\omega = \bar{\partial}g_\alpha$  there, and hence  $\bar{\partial}\omega = 0$ ) and has smooth coefficients.

By Theorem 1 there is a smooth function  $g$  in  $D$  such that  $\bar{\partial}g = \omega$ . Then for all  $\alpha$  the function  $h_\alpha = g_\alpha - g$  will be holomorphic in  $U_\alpha$ , since  $\bar{\partial}h_\alpha = \bar{\partial}g_\alpha - \omega = 0$  there. It remains to write

$$h_{\alpha\beta} = (g_\beta - g) - (g_\alpha - g) = h_\beta - h_\alpha \quad (11)$$

instead of (10).

Thus we have resolved the cocycle  $\{h_{\alpha\beta}\}$  into holomorphic functions, and by Theorem 1 of the previous subsection this is sufficient for the corresponding Cousin problem to be solvable. ▶

**REMARK.** The first of the two facts on which our solution of the first Cousin problem is based—the triviality of the cohomology group  $H^1(\mathcal{U}, \mathcal{F})$  with smooth coefficients—holds for any open covering of an arbitrary smooth manifold (see Theorem 2 of subsection 44). The second fact—the solvability of the  $\bar{\partial}$ -problem on the manifold  $M$ , or equivalently, the triviality of the quotient group  $\tilde{H}^1(M)$  of closed  $(0, 1)$ -forms modulo exact forms—is significantly more subtle and does not always hold.

The difficulties arising in the solution of the  $\bar{\partial}$ -problem are caused by the fact that the system  $\bar{\partial}f = \omega$  is overdetermined for  $n > 1$ : it leads to  $n$  complex conditions on a single unknown function  $f$ . However, if the form  $\omega$  in the right-hand side is compactly supported in  $D$  (and, of course,  $\bar{\partial}$ -closed), then the problem is easy to solve: it suffices to extend  $\omega$  into some polydisc containing  $D$ , by setting it equal to zero outside the support, and to use Theorem 1 proved above. Thus, the main difficulty in this problem is to exclude the influence of the boundary of the domain.

A large number of research papers devoted to the  $\bar{\partial}$ -problem were completed by the work of LARS HÖRMANDER, who proved that the influence of the boundary can be excluded for all pseudoconvex domains, and hence, for all domains of holomorphy (no condition is required about the smoothness of the boundary). We give his result without proof.<sup>(3)</sup>

**THEOREM (L. Hörmander).** *In any pseudoconvex domain  $D \subset \mathbb{C}^n$  the equation  $\bar{\partial}f = \omega$  is solvable in the class  $C^\infty(D)$  for any  $\bar{\partial}$ -closed  $(0, 1)$ -form with smooth coefficients in  $D$ , i.e., for such a domain*

$$\tilde{H}^1(D) = Z^{0,1}/B^{0,1} = 0. \quad (12)$$

Based on these facts, we can repeat the proof of Theorem 2, and then we obtain a general theorem concerning the solvability of the first Cousin problem for coverings:

**THEOREM 3.** *For any covering  $\{U_\alpha\}$  of a pseudoconvex domain  $D \subset \mathbb{C}^n$  any first Cousin problem  $\{f_\alpha\}$  is solvable.*

\* Consider domains  $D_1, D_2 \subset \mathbb{C}^n$  such that  $D_1 \cap D_2 = D$  is a domain of holomorphy. Prove that any  $f \in \mathcal{O}(D)$  can be represented in the form  $f_1 + f_2$ , where  $f_j \in \mathcal{O}(D_j)$ ,  $j = 1, 2$ . \*

## §16. Methods of sheaf theory

In this section we shall acquaint the reader with methods that arose in combining the ideas of complex analysis with those of algebra and topology. Most of the credit in the development of these methods is due to the French mathematical school, primarily to H. CARTAN and J.-P. SERRE. The aim is not the methods themselves but their applications. Therefore we shall omit the proofs of some statements.

We start with a generalization of the terms introduced in subsection 44, extending them from meromorphic functions to sections of an arbitrary sheaf of algebraic structures of some kind. For definiteness we shall have in mind sheaves of abelian groups with addition as the operation.

**46. Cohomology groups.** We consider a covering  $\mathcal{U} = \{U_\alpha\}_{\alpha \in A}$  of a topological space  $M$ , over which a sheaf of abelian groups  $\mathcal{S}$  is given. Fix

<sup>(3)</sup>See Hörmander's book cited in §14, Theorem 4.2.5.

an integer  $r \geq 0$  and, for an arbitrary multi-index  $\alpha = (\alpha_0, \dots, \alpha_r) \in \mathbf{A}^{r+1}$ , let

$$U_\alpha = U_{\alpha_0} \cap \dots \cap U_{\alpha_r} \quad (1)$$

be the intersection of  $r + 1$  sets of the covering.

A *cochain* of order  $r$  for the given covering  $\mathcal{U}$  of  $M$  with coefficients in the sheaf  $\mathcal{S}$  is a function  $h$  that to each multi-index  $\alpha \in \mathbf{A}^{r+1}$  associates a section  $h_\alpha \in \Gamma(U_\alpha, \mathcal{S})$  (see subsection 28) and is skew-symmetric with respect to the indices, i.e., preserves its value under an even permutation of the indices and changes sign under an odd permutation (recall that the operations in the stalks extend to the sections of a sheaf). If  $U_\alpha$  is empty, we shall assume that  $h_\alpha \equiv 0$ . The set of all cochains of order  $r$  for the covering  $\mathcal{U}$  with coefficients in the sheaf  $\mathcal{S}$  will be denoted by  $C^r(\mathcal{U}, \mathcal{S})$ ; this is a group under the operation in the stalks.

We now define a *coboundary operator*  $\delta$ , which associates to each cochain of order  $r$  a cochain  $\delta h$  of order  $r + 1$  according to the rule

$$(\delta h)_{\alpha_0 \dots \alpha_{r+1}} = \sum_{\nu=0}^{r+1} (-1)^\nu h_{\alpha_0 \dots \hat{\alpha}_\nu \dots \alpha_{r+1}} \quad (2)$$

(the index  $\alpha_\nu$  on the right-hand side is omitted). The mapping

$$\delta: C^r(\mathcal{U}, \mathcal{S}) \rightarrow C^{r+1}(\mathcal{U}, \mathcal{S}) \quad (3)$$

is obviously a homomorphism of the corresponding groups of cochains.

The operator  $\delta$  is analogous to the boundary operator  $\partial$  (subsection 14); like the latter, it is idempotent, i.e., its square is equal to zero:

$$\delta^2 = \delta \cdot \delta = 0. \quad (4)$$

A cochain  $h \in C^r(\mathcal{U}, \mathcal{S})$  is called a *cocycle* if its coboundary  $\delta h = 0$ ; the set

$$Z^r(\mathcal{U}, \mathcal{S}) = \{h \in C^r(\mathcal{U}, \mathcal{S}): \delta h = 0\} \quad (5)$$

is called the *rth group of cocycles* (with coefficients in  $\mathcal{S}$ ). A cocycle  $h \in C^r$  is said to be *cohomologous to zero* or a *coboundary* if there exists a cochain  $g \in C^{r-1}(\mathcal{U}, \mathcal{S})$  such that  $\delta g = h$ ; the group of such cocycles will be denoted  $B^r(\mathcal{U}, \mathcal{S})$ . It is a subgroup of the group (5), and the quotient-group

$$H^r(\mathcal{U}, \mathcal{S}) = Z^r(\mathcal{U}, \mathcal{S}) / B^r(\mathcal{U}, \mathcal{S}) \quad (6)$$

is called the *rth cohomology group* (with coefficients in  $\mathcal{S}$ ) for the covering  $\mathcal{U}$ .

In the special case  $r = 1$  the cochains  $\{h_{\alpha_0 \alpha_1}\}$  are defined on the intersections  $U_{\alpha_0 \alpha_1}$  of sets of the covering so that  $h_{\alpha_0 \alpha_1} + h_{\alpha_1 \alpha_0} = 0$  (skew-symmetry with respect to the indices). The coboundary operator maps them to cochains of order 2 such that  $(\delta h)_{\alpha_0 \alpha_1 \alpha_2} = h_{\alpha_1 \alpha_2} - h_{\alpha_0 \alpha_2} + h_{\alpha_0 \alpha_1}$  in  $U_{\alpha_0 \alpha_1 \alpha_2}$ . Therefore the cochains for which  $h_{\alpha_1 \alpha_2} + h_{\alpha_2 \alpha_0} + h_{\alpha_0 \alpha_1} = 0$  will be cocycles. The



coboundary of a cochain  $\{h_\alpha\}$  of order 0 is a cochain  $(\delta h)_{\alpha_0\alpha_1} = h_{\alpha_1} - h_{\alpha_0}$ , and hence the coboundaries of order 1 will be those cocycles for which  $h_{\alpha_0\alpha_1} = h_{\alpha_1} - h_{\alpha_0}$ . The terminology introduced here for  $r = 1$  coincides with that considered in subsection 44, and the cohomology group defined there is the group  $H^1(\mathcal{U}, \mathcal{O})$ .

We also consider the cohomology group of order zero. The cocycles here will be cochains  $\{h_\alpha\}$  for which  $h_{\alpha_1} - h_{\alpha_0} = 0$  in each intersection  $U_{\alpha_0\alpha_1}$ . Consequently, each cocycle  $h$  of order zero defines a section of the sheaf  $\mathcal{S}$  OVER THE WHOLE space  $M$ , i.e., a *global section*—an element of the group  $\Gamma(M, \mathcal{S})$  whose restriction to each  $U_\alpha$  coincides with  $h_\alpha$ . The empty set is by definition a cochain of order 1 and, hence, a coboundary of order zero is only the zero cocycle. Factorization by it is trivial, and, hence, we have the following

**THEOREM 1.** *The zeroth cohomology group with coefficients in the sheaf  $\mathcal{S}$  over a topological space  $M$  for any covering  $\mathcal{U}$  coincides with the group of global sections of this sheaf:*

$$H^0(\mathcal{U}, \mathcal{S}) \approx \Gamma(M, \mathcal{S}). \tag{7}$$

We also note that Theorem 2 of subsection 44 concerning the triviality of the group  $H^1(\mathcal{U}, \mathcal{F})$  carries over almost without changes to higher cohomology groups. Namely, we have

**THEOREM 2.** *For any open covering  $\mathcal{U}$  of a complex manifold  $M$  the cohomology groups with coefficients in the sheaf  $\mathcal{F}^{0,s}$  of germs of smooth  $(0, s)$ -forms are trivial:*

$$H^r(\mathcal{U}, \mathcal{F}^{0,s}) = 0 \text{ for all } r \geq 1 \text{ and } s \geq 0. \tag{8}$$

◀ We must prove that any cocycle  $\omega = \{\omega_{\alpha_0 \dots \alpha_r}, \alpha_\nu \in A\}$  is a coboundary. Take a partition of unity subordinate to the covering  $\mathcal{U}$  and satisfying the condition that was indicated in the proof of Theorem 2 of subsection 44, and, for  $\alpha = (\alpha_0, \dots, \alpha_{r-1}) \in A^r$  and  $\beta \in A$ , set

$$\omega'_{\beta\alpha} = \begin{cases} e_\beta \omega_{\beta\alpha} & \text{in } U_{\beta\alpha}, \\ 0 & \text{in } U_\alpha \setminus U_{\beta\alpha}, \end{cases} \quad \omega'_\alpha = \sum_{\beta \in A} \omega'_{\beta\alpha}.$$

We have obtained a cochain  $\omega'$  of order  $r - 1$ ; its coboundary

$$(\delta\omega')_{\alpha, \alpha_r} = \sum_{\nu=0}^r (-1)^\nu \omega'_{\alpha_0 \dots \hat{\alpha}_\nu \dots \alpha_r} = \sum_{\beta \in A} e_\beta \sum_{\nu=0}^r (-1)^\nu \omega_{\beta\alpha_0 \dots \hat{\alpha}_\nu \dots \alpha_r}.$$

But  $\omega_{\alpha_0 \dots \alpha_r} - \sum_{\nu=0}^r (-1)^\nu \omega_{\beta\alpha_0 \dots \hat{\alpha}_\nu \dots \alpha_r} = 0$ , since  $\omega$  is a cocycle; hence

$$(\delta\omega')_{\alpha, \alpha_r} = \sum_{\beta \in A} e_\beta \omega_{\alpha_0 \dots \alpha_r} = \omega_{\alpha_0 \dots \alpha_r} \sum_{\beta \in A} e_\beta = \omega_{\alpha_0 \dots \alpha_r},$$

i.e.,  $\delta\omega' = \omega$ . ▶

\* Suppose  $\mathbb{P}^1 = \{[w_0, w_1]\}$  is covered in a standard way by the two domains  $U_0 = \{w_0 \neq 0\}$  and  $U_1 = \{w_1 \neq 0\}$ . Prove that for this covering  $H^0(\mathcal{U}, \mathcal{O}) = \mathbb{C}$  and  $H^k(\mathcal{U}, \mathcal{O}) = 0$  for  $k \geq 1$ . [HINT: consider the power series expansion of functions with respect to the local coordinate  $z = w_1/w_0$ , and compare the expansions in  $U_0$ ,  $U_1$ , and  $U_{01} = \{0 < |z| < \infty\}$ ; for  $k > 1$  the result is trivial.] \*

We now pass from cohomology groups for coverings to cohomology groups of the space itself. For this we need to construct a process of localization, analogous to the process of going from presheaves to sheaves in subsection 28. In fact, we place a partial order on the set of coverings by inclusion, and define homomorphisms relating the groups for two coverings, one of which is finer than the other, and using these homomorphisms we pass to the direct limit.

Suppose we are given two coverings  $\mathcal{U} = \{U_\alpha\}_{\alpha \in A}$  and  $\mathcal{V} = \{V_\beta\}_{\beta \in B}$ ; we say that the second covering is *finer* than the first (notation:  $\mathcal{V} \prec \mathcal{U}$ ) if there exists a mapping

$$\rho: B \rightarrow A \tag{9}$$

such that  $V_\beta \subset U_{\rho(\beta)}$  for any  $\beta \in B$ . For a given  $\rho$  to each cochain  $h \in C^r(\mathcal{U})$  one can associate a cochain  $\rho h \in C^r(\mathcal{V})$ , by setting, for each multi-index  $\beta \in B^{r+1}$ , the value of  $(\rho h)_\beta$  equal to the restriction of  $h_{\rho(\beta)}$  on  $V_\beta$ .<sup>(4)</sup> Since we have  $\delta(\rho h) = \rho(\delta h)$  for any cochain  $h$  (here  $\delta$  is the coboundary operator), then  $\rho$  induces a mapping

$$\rho^*: H^r(\mathcal{U}, \mathcal{S}) \rightarrow H^r(\mathcal{V}, \mathcal{S}), \tag{10}$$

which is obviously a homomorphism of groups.

LEMMA. *If  $\mathcal{V} \prec \mathcal{U}$ , then the homomorphism  $\rho^*$  does not depend on the choice of the mapping (9).*

◀ For  $r = 0$  the assertion is obvious in view of Theorem 1, and therefore we may assume that  $r \geq 1$ . Suppose that besides  $\rho$  we are given another mapping  $\rho': B \rightarrow A$  such that  $V_\beta \subset U_{\rho'(\beta)}$  for all  $\beta \in B$ . Define a mapping  $\sigma: C^{r+1}(\mathcal{U}) \rightarrow C^r(\mathcal{V})$ , by setting

$$(\sigma h)_\beta = \sum_{\nu=0}^r (-1)^\nu h_{\rho(\beta_0) \dots \rho(\beta_\nu) \rho'(\beta_{\nu+1}) \dots \rho'(\beta_r)} \tag{11}$$

for each  $\beta \in B^{r+1}$  with ordered indices  $\beta_0 < \beta_1 < \dots < \beta_r$  and each cochain  $h \in C^{r+1}(\mathcal{U})$ . A direct computation<sup>(5)</sup> shows that, for all  $h \in C^{r+1}(\mathcal{U})$ ,

$$\sigma(\delta h) + \delta(\sigma h) = \rho' h - \rho h.$$

<sup>(4)</sup>In correspondence with the notations adopted above

$$\beta = (\beta_0, \dots, \beta_r), \quad \rho(\beta) = (\rho(\beta_0), \dots, \rho(\beta_r)), \quad \text{and} \quad V_\beta = V_{\beta_0} \cap \dots \cap V_{\beta_r};$$

the symbol for the sheaf  $\mathcal{S}$  is omitted in the notation for the group  $C^r$  and others.

<sup>(5)</sup>We give this computation for  $r = 1$ . Let  $\beta = (\beta_0, \beta_1)$ ,  $\rho(\beta_\nu) = \alpha_\nu$ ,  $\rho'(\beta_\nu) = \alpha'_\nu$ ; we have

$$(\rho' h - \rho h)_\beta = h_{\alpha'_0 \alpha'_1} - h_{\alpha_0 \alpha_1}.$$

In particular, if  $h$  is a cocycle ( $\delta h = 0$ ), then  $\rho'h - \rho h = \delta(\sigma h)$ , and hence,  $\rho h$  and  $\rho'h$  belong to the same equivalence class under factorization by coboundaries. From this we see that one and the same homomorphism of the groups  $H^r(\mathcal{U})$  and  $H^r(\mathcal{V})$  corresponds to  $\rho$  and  $\rho'$ . ►

According to this lemma  $\rho^* = \rho_{\mathcal{U}\mathcal{V}}$  depends only on the coverings (for given  $M$  and  $\mathcal{S}$ ). From it we also see that this mapping satisfies a transitivity condition: if  $\mathcal{W} \prec \mathcal{V} \prec \mathcal{U}$ , then

$$\rho_{\mathcal{U}\mathcal{W}} = \rho_{\mathcal{V}\mathcal{W}} \circ \rho_{\mathcal{U}\mathcal{V}}. \tag{12}$$

Thus, we actually have the same situation as in subsection 28 (with the only difference being that instead of sets we are here considering systems of sets, namely coverings), and we are able to realize the desired localization.

For this we consider all possible coverings of  $M$  and we will say that elements  $f \in H^r(\mathcal{U})$  and  $g \in H^r(\mathcal{V})$  are equivalent if there exists a covering  $\mathcal{W}$  such that  $\mathcal{W} \prec \mathcal{U}$ ,  $\mathcal{W} \prec \mathcal{V}$ , and also  $\rho_{\mathcal{U}\mathcal{W}}(f) = \rho_{\mathcal{V}\mathcal{W}}(g)$ . The set of equivalence classes under this relation, i.e., the direct limit

$$\lim_{\mathcal{U}} H^r(\mathcal{U}, \mathcal{S}) = H^r(M, \mathcal{S}), \tag{13}$$

is called the *r*th cohomology group of  $M$  (with coefficients in the sheaf  $\mathcal{S}$ ).

REMARK. From this definition we see that if, for a space  $M$ , there exist arbitrarily fine coverings  $\mathcal{U}$  for which  $H^r(\mathcal{U}, \mathcal{S}) = 0$ , then we also have  $H^r(M, \mathcal{S}) = 0$ .

Note that for  $r = 1$  the converse is also true: if  $H^1(M, \mathcal{S}) = 0$ , then  $H^1(\mathcal{U}, \mathcal{S}) = 0$  for any covering  $\mathcal{U}$ . This follows from the fact that for  $r = 1$  the homomorphism  $\rho^*: H^1(\mathcal{U}) \rightarrow H^1(\mathcal{V})$  is injective, i.e., the inverse image of a coboundary is again a coboundary.

For the proof of this fact we consider a cocycle  $h \in Z^1(U)$  for which  $\rho^*h = \delta h'$ , where  $h' \in C^0(V)$ . Then for any  $\beta_0, \beta_1 \in B$  we have  $h_{\alpha_0\alpha_1} = h'_{\beta_1} - h'_{\beta_0}$  in the intersection  $V_{\beta_0\beta_1}$  (and it belongs to  $U_{\alpha_0\alpha_1}$ , where  $\alpha_j = \rho(\beta_j)$ ). Since  $h$  is a cocycle, then for any  $\alpha \in A$  we have the relation  $h_{\alpha_0\alpha_1} - h_{\alpha_0\alpha} + h_{\alpha_1\alpha} = 0$  in the intersection  $U_\alpha \cap V_{\beta_0\beta_1}$ , or, taking the foregoing into account,

$$h'_{\beta_0} + h_{\alpha_0\alpha} = h'_{\beta_1} + h_{\alpha_1\alpha}.$$

This means that a section of  $\Gamma(U_\alpha)$  is defined, which for any  $\beta \in B$  is given in  $U_\alpha \cap V_\beta$  by the equality  $h_\alpha = h'_\beta + h_{\rho(\beta)\alpha}$ . But then in the intersections

On the other hand,  $(\delta h)_{\alpha_0\alpha_1\alpha_2} = h_{\alpha_1\alpha_2} - h_{\alpha_0\alpha_2} + h_{\alpha_0\alpha_1}$  and, hence, by (11)

$$[\sigma(\delta h)]_\beta = (\delta h)_{\alpha_0\alpha'_0\alpha'_1} - (\delta h)_{\alpha_0\alpha_1\alpha'_1} = h_{\alpha'_0\alpha'_1} + h_{\alpha_0\alpha'_0} - (h_{\alpha_1\alpha'_1} + h_{\alpha_0\alpha_1}).$$

But, by the formula corresponding to (11) for  $r = 0$  we will obtain  $(\sigma h)_{\beta_0} = h_{\alpha_0\alpha'_0}$ , whence  $[\delta(\sigma h)]_\beta = (\sigma h)_{\beta_1} - (\sigma h)_{\beta_0} = h_{\alpha_1\alpha'_1} - h_{\alpha_0\alpha'_0}$ . Thus, we have

$$[\sigma(\delta h) + \delta(\sigma h)]_\beta = h_{\alpha'_0\alpha'_1} - h_{\alpha_0\alpha'_1}.$$

$U_{\alpha_0\alpha_1} \cap V_\beta$  we obtain

$$h_{\alpha_1} - h_{\alpha_0} = h'_\beta + h_{\rho(\beta)\alpha_1} - h'_\beta - h_{\rho(\beta)\alpha_0} = h_{\rho(\beta)\alpha_1} - h_{\rho(\beta)\alpha_0} = h_{\alpha_0\alpha_1}$$

(we have again used the fact that  $h$  is a cocycle), i.e.,  $h$  is a coboundary.

A simple sufficient condition for passage from the cohomology of coverings to the cohomology of a space is given by a theorem of J. LERAY:  $H^r(\mathcal{U}, \mathcal{S}) = H^r(M, \mathcal{S})$  for all  $r \geq 0$  if the covering  $\mathcal{U} = \{U_\alpha\}$  is such that for all  $k > 0$  and all intersections  $U_\alpha = U_{\alpha_1} \cap \dots \cap U_{\alpha_k}$  the groups  $H^r(U_\alpha, \mathcal{S}) = 0$ .

**47. Exact sequences of sheaves.** We start with the concept of a mapping of sheaves, which is entirely analogous to the concept of a mapping of Riemann domains (see subsection 22). Suppose we are given two sheaves  $(\mathcal{S}, \sigma)$  and  $(\mathcal{T}, \tau)$  over the same space  $M$ . A mapping of sheaves

$$\varphi: \mathcal{S} \rightarrow \mathcal{T} \tag{1}$$

is a continuous mapping of the topological space  $\mathcal{S}$  into  $\mathcal{T}$  for which

$$\tau \circ \varphi = \sigma \tag{2}$$

everywhere in  $\mathcal{S}$ . The concept of a mapping of sheaves is introduced so that it preserves stalks: for any point  $p \in M$  we have  $\varphi(\mathcal{S}_p) \subset \mathcal{T}_p$ . It also preserves sections: if  $f$  is an arbitrary section of the sheaf  $\mathcal{S}_U$  over an open set  $U \subset M$ , then the mapping  $\varphi \circ f$  is continuous in  $U$  and  $\tau \circ (\varphi \circ f) = \sigma \circ f$  is the identity (by the definition of a section of  $\mathcal{S}_U$ ), but this means that  $\varphi \circ f \in \mathcal{T}_U$ .

A mapping  $\varphi: \mathcal{S} \rightarrow \mathcal{T}$  is called a *homomorphism of sheaves* if it is a mapping of these sheaves that also preserves the algebraic operations in all the stalks. A homomorphism  $\varphi$  of sheaves is called an *isomorphism* if  $\varphi$  is a one-to-one mapping onto  $\mathcal{T}$ .

Further, let  $(\mathcal{S}, \sigma)$  be a sheaf of abelian groups over  $M$  and consider a set  $\mathcal{T} \subset \mathcal{S}$ ; we shall say that  $(\mathcal{T}, \sigma)$  is a *subsheaf* of the sheaf  $(\mathcal{S}, \sigma)$  if: (1)  $\mathcal{T}$  is open in  $\mathcal{S}$ , (2)  $\sigma(\mathcal{T}) = M$ , and (3) for any point  $p \in M$  the stalk  $\mathcal{T}_p$  is a subgroup of the group  $\mathcal{S}_p$ .

If  $\mathcal{T}$  is a subsheaf of a sheaf of abelian groups  $\mathcal{S}$ , then for each point  $p \in M$  one can form the quotient group  $\mathcal{F}_p = \mathcal{S}_p / \mathcal{T}_p$ ; the union of these quotient groups

$$\mathcal{S} / \mathcal{T} = \bigcup_{p \in M} \mathcal{S}_p / \mathcal{T}_p, \tag{3}$$

equipped with the quotient topology,<sup>(6)</sup> is called a *quotient sheaf* on  $M$ .

**EXAMPLES.**

1. Let  $0$  be the trivial sheaf over a complex manifold  $M$  (at each point  $p \in M$  the stalk of this sheaf consists of a single zero), let  $\mathbb{C}$  be the constant sheaf,  $\mathcal{O}$  the sheaf of germs of holomorphic functions, and  $\mathcal{F}$  the sheaf of germs of  $C^\infty$  functions, all over the same  $M$ .

<sup>(6)</sup>The quotient topology is the topology in  $\mathcal{S} / \mathcal{T}$  whose open sets are sets of equivalence classes of open sets of the space  $\mathcal{S}$ .

Each of these sheaves is a subsheaf of the following one (verify the condition of openness in the definition of a subsheaf).

2. The sheaf  $\mathcal{O}$  over a complex manifold  $M$  is a subsheaf of the sheaf  $\mathcal{M}$  of germs of meromorphic functions on  $M$ . We shall consider  $\mathcal{O}$  and  $\mathcal{M}$  as sheaves of ADDITIVE GROUPS (relative to addition); then for any  $p \in M$  the stalk  $\mathcal{O}_p$  is a subgroup of  $\mathcal{M}_p$ , and we can form the quotient sheaf

$$\mathcal{M}/\mathcal{O} = \bigcup_{p \in M} \mathcal{M}_p/\mathcal{O}_p. \tag{4}$$

The elements of this quotient sheaf are the classes of germs of meromorphic functions at the point  $p \in M$ , whose differences are germs of holomorphic functions. (In other words, the elements of  $\mathcal{M}/\mathcal{O}$  are the equivalence classes of germs  $f_p \in \mathcal{M}_p$ , where  $f'_p$  and  $f''_p$  are equivalent if  $f'_p - f''_p \in \mathcal{O}_p$ .) As we shall soon see, this sheaf is related to the first Cousin problem.

3. We remove from the sheaf  $\mathcal{M}$  the germs corresponding to the zero section (i.e., functions that are identically zero on  $M$ ); then  $\mathcal{M}^* = \mathcal{M} \setminus \{0\}$  can be considered as a sheaf of MULTIPLICATIVE GROUPS with multiplication as the group operation. The sheaf  $\mathcal{O}^*$  is assumed to consist of the invertible elements of the rings  $\mathcal{O}_p$ ,  $p \in M$ , i.e., elements corresponding to functions that do not vanish at the point  $p$ .  $\mathcal{O}^*$  is obviously a subsheaf  $\mathcal{M}^*$ , and we can form the quotient sheaf

$$\mathcal{M}^*/\mathcal{O}^* = \bigcup_{p \in M} \mathcal{M}^*_p/\mathcal{O}^*_p. \tag{5}$$

The elements of this quotient sheaf are the classes of germs of meromorphic functions, not identically zero, whose quotient is a germ of a holomorphic function that does not vanish (in other words, they are the equivalence classes of germs  $f \in \mathcal{M}^*$ , where  $f'$  and  $f''$  are equivalent if  $f'(f'')^{-1} \in \mathcal{O}^*$ ). As we shall soon see, this sheaf is related to the so-called second Cousin problem.

We now pass to the definition of the concept of an exact sequence of sheaves, which is fundamental for this subsection. Suppose we are given two homomorphisms of sheaves of abelian groups:

$$\mathcal{S}_0 \xrightarrow{\varphi_1} \mathcal{S}_1 \xrightarrow{\varphi_2} \mathcal{S}_2; \tag{6}$$

we will say that the sequence (6) is *exact at the term*  $\mathcal{S}_1$  if

$$\text{im } \varphi_1 = \ker \varphi_2. \tag{7}$$

Recall that the symbol  $\text{im } \varphi_1 = \varphi_1(\mathcal{S}_0)$  denotes the subgroup of elements of  $\mathcal{S}_1$  that are images of elements of  $\mathcal{S}_0$  (the image of the homomorphism  $\varphi_1$ ), and the symbol  $\ker \varphi_2$  denotes the subgroup of  $\mathcal{S}_1$  formed by the elements that  $\varphi_2$  maps to zero in the group  $\mathcal{S}_2$  (the kernel of the homomorphism  $\varphi_2$ ). Thus, the exactness of the sequence (6) means that  $\varphi_2$  maps to 0 exactly those elements of  $\mathcal{S}_1$  that come from  $\mathcal{S}_0$  via  $\varphi_1$  (Figure 45).

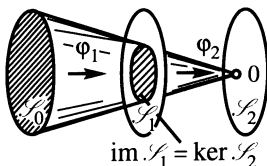

FIGURE 45

A sequence of an arbitrary number of sheaves of abelian groups

$$\dots \rightarrow \mathcal{S}_{i-1} \xrightarrow{\varphi_i} \mathcal{S}_i \xrightarrow{\varphi_{i+1}} \mathcal{S}_{i+1} \rightarrow \dots \tag{8}$$

is said to be *exact* if it is exact at each  $\mathcal{S}_i$ .

EXAMPLES.

4. The exactness of the sequence

$$0 \xrightarrow{i} \mathcal{S}_1 \xrightarrow{\varphi} \mathcal{S}_2 \xrightarrow{j} 0, \tag{9}$$

where the elements on the left and right ends are trivial sheaves (all of whose stalks are groups consisting solely of zero) and  $i$  is the inclusion, means that  $\varphi$  is an isomorphism of  $\mathcal{S}_1$  onto  $\mathcal{S}_2$ . In fact, since  $\ker \varphi = \text{im } i = 0$ , the mapping  $\varphi$  is injective, and since  $\text{im } \varphi = \ker j = \mathcal{S}_2$ , it is surjective.

5. The sequence

$$0 \rightarrow \mathcal{S} \xrightarrow{i} \mathcal{T} \xrightarrow{\varphi} \mathcal{T}/\mathcal{S} \rightarrow 0, \tag{10}$$

where  $\mathcal{S}$  is a subsheaf of  $\mathcal{T}$ ,  $i$  is the inclusion, and  $\varphi$  is the natural homomorphism that to each element of  $\mathcal{T}$  associates the equivalence class containing it, is exact. In fact, the exactness of (10) at  $\mathcal{S}$  follows from the fact that  $i$  is injective, exactness at  $\mathcal{T}$  follows from the fact that  $\varphi \circ i$  maps  $\mathcal{S}$  to zero, and exactness at the term  $\mathcal{T}/\mathcal{S}$  follows from the fact that  $\varphi$  is surjective.

6. More generally, the exactness of a sequence of sheaves of abelian groups

$$\mathcal{S}_1 \xrightarrow{\varphi_1} \mathcal{S}_2 \xrightarrow{\varphi_2} \mathcal{S}_3 \rightarrow 0 \tag{11}$$

means that  $\varphi_2$  is surjective and

$$\mathcal{S}_3 \approx \mathcal{S}_2/\varphi_1(\mathcal{S}_1) \tag{12}$$

—the image  $\text{im } \varphi_2 = \mathcal{S}_3$  of the group  $\mathcal{S}_2$  is isomorphic to its quotient group modulo the kernel  $\ker \varphi_2 = \varphi_1(\mathcal{S}_1)$ .

In conclusion we point out without proof<sup>(7)</sup> one of the two theorems on which applications of sheaf theory to analysis are based. We shall discuss the second of them in the following subsection.

**THEOREM I** (concerning exact sequences). *Suppose that the space  $M$  is Hausdorff and has a countable base of open sets. Then to every exact sequence of sheaves over  $M$*

$$0 \rightarrow \mathcal{S}' \xrightarrow{\varphi} \mathcal{S} \xrightarrow{\psi} \mathcal{S}'' \rightarrow 0 \tag{13}$$

there corresponds an exact sequence of cohomology groups

$$\begin{aligned} 0 \rightarrow H^0(M, \mathcal{S}') &\xrightarrow{\varphi_*} H^0(M, \mathcal{S}) \xrightarrow{\psi_*} H^0(M, \mathcal{S}'') \\ &\xrightarrow{\delta_*} H^1(M, \mathcal{S}') \xrightarrow{\varphi_*} H^1(M, \mathcal{S}) \\ &\xrightarrow{\psi_*} H^1(M, \mathcal{S}'') \xrightarrow{\delta_*} H^2(M, \mathcal{S}') \rightarrow \dots \end{aligned} \tag{14}$$

and so on, up to all dimensions.

**48. Localized first Cousin problem.** A sheaf  $\mathcal{M}$  of germs of meromorphic functions over a complex manifold  $M$  can be obtained from a presheaf of its sections  $\Gamma(U_\alpha, \mathcal{M})$  in the domains of the covering  $\mathcal{U} = \{U_\alpha\}_{\alpha \in A}$  of this manifold as a result of localization, passage to the limit over a contracting

<sup>(7)</sup>For a proof see Hörmander's book cited at the end of subsection 41.

system of coverings (see subsection 28). The data of the first Cousin problem for the covering  $\mathcal{U}$  consist of a collection of sections  $f_\alpha \in \Gamma(U_\alpha, \mathcal{M})$  satisfying another compatibility condition: in all the intersections  $U_{\alpha\beta} = U_\alpha \cap U_\beta$  of domains of the covering the differences  $f_\alpha - f_\beta \in \Gamma(U_{\alpha\beta}, \mathcal{O})$ , i.e., are holomorphic, and the problem is to look for a function  $f \in \Gamma(M, \mathcal{M})$  such that  $f - f_\alpha \in \Gamma(U_\alpha, \mathcal{O})$  in each  $U_\alpha$ ,  $\alpha \in A$ . Thus, the statement of the problem has a “presheaf” nature.

It is obviously not difficult to formulate a LOCALIZED variant of it, in which instead of the presheaf of sections we consider the sheaf  $\mathcal{M}$  itself. In this variant compatible Cousin data form a section of the quotient sheaf  $\mathcal{M}/\mathcal{O}$  on the whole manifold  $M$ , i.e., they form an element of the group  $\Gamma(M, \mathcal{M}/\mathcal{O})$ . In fact, a section assigns a germ from the quotient group  $\mathcal{M}_p/\mathcal{O}_p$  to each point  $p \in M$ , i.e., a germ of a meromorphic function, defined up to a term which is a germ of a holomorphic function at this point. The problem is to look for a section  $f \in \Gamma(M, \mathcal{M})$ , corresponding to a given section in the sense that for any  $p \in M$  the germ  $f_p$  is equal to the given germ also up to a germ of a holomorphic function.

To solve the localized first Cousin problem we need Hörmander’s general theorem about the solvability of the  $\bar{\partial}$ -problem, a special case of which is stated at the end of subsection 45: instead of  $(0, 1)$ -forms we actually need to consider  $(0, s)$ -forms, and instead of pseudoconvex domains we need to consider arbitrary Stein manifolds (see subsection 41).

**THEOREM II** (the solvability of the  $\bar{\partial}$ -problem). *On any Stein manifold  $M$  the  $s$ th cohomology group relative to the operator  $\bar{\partial}$  (i.e., the quotient group of the group  $Z^{0,s}$  of  $\bar{\partial}$ -closed forms of bidegree  $(0, s)$  on  $M$  with smooth coefficients modulo the subgroup  $B^{0,s}$  of exact  $(0, s)$ -forms) is trivial for all  $s \geq 1$ :*

$$\tilde{H}^s(M) = Z^{0,s}/B^{0,s} = 0 \quad \text{for } s = 1, 2, \dots \tag{1}$$

In other words, on a Stein manifold the equation

$$\bar{\partial}\sigma = \omega \tag{2}$$

is solvable in the class  $\mathcal{F}^{0,s-1}$  for any form  $\omega \in \mathcal{F}^{0,s}$  for which  $\bar{\partial}\omega = 0$ . We omit the proof.<sup>(8)</sup> Using Theorem II one proves

**THEOREM 1** (Dolbeault). *For any complex manifold  $M$  the cohomology group of order  $s$  with holomorphic coefficients for any  $s \geq 1$  is isomorphic to the group  $\tilde{H}^s(M)$ :*

$$H^s(M, \mathcal{O}) \simeq Z^{0,s}/B^{0,s} \quad \text{for } s = 1, 2, \dots \tag{3}$$

◀ Denote by  $\tilde{\mathcal{F}}^s$  and  $\tilde{Z}^s$  respectively the sheaves of germs of smooth and closed (relative to the operator  $\bar{\partial}$ ) forms of bidegree  $(0, s)$  over the manifold

---

<sup>(8)</sup>See Hörmander’s book, cited at the end of subsection 41, Corollary 5.2.6.

$M$ , considering them as sheaves of abelian groups relative to addition. The sequence of sheaves

$$0 \xrightarrow{i} \tilde{Z}^{s-1} \xrightarrow{i} \tilde{\mathcal{F}}^{s-1} \xrightarrow{\bar{\partial}} \tilde{Z}^s \rightarrow 0, \quad (4)$$

where  $i$  is inclusion, is exact for any  $s \geq 1$ . In fact, at the first term  $\text{im } i = \ker i = 0$ , at the second term  $\text{im } i = \ker \bar{\partial} = \tilde{Z}^{s-1}$ , and at the third term  $\text{im } \bar{\partial} = \tilde{Z}^s$ ; the last assertion follows from the fact that each point  $p \in M$  has a contracting system of neighborhoods, which are Stein manifolds (for example, biholomorphic images of balls of the space of local coordinates), and in such neighborhoods by Theorem II every closed form is exact.

By Theorem I from the preceding subsection the sequence of cohomology groups

$$\begin{aligned} 0 \rightarrow H^0(\tilde{Z}^{s-1}) \rightarrow H^0(\tilde{\mathcal{F}}^{s-1}) \rightarrow H^0(\tilde{Z}^s) \rightarrow H^1(\tilde{Z}^{s-1}) \\ \rightarrow H^1(\tilde{\mathcal{F}}^{s-1}) \rightarrow H^1(\tilde{Z}^s) \rightarrow H^2(\tilde{Z}^{s-1}) \rightarrow \dots \end{aligned} \quad (5)$$

is also exact (the symbol  $M$  is omitted in the notation of these groups). Recall that the zeroth cohomology groups are the global sections and that by Theorem 2 of subsection 46  $H^r(\tilde{\mathcal{F}}^s) = 0$  for all  $r \geq 1$  and  $s \geq 0$ . Therefore from (5) we have

$$\Gamma(\tilde{\mathcal{F}}^{s-1}) \rightarrow \Gamma(\tilde{Z}^s) \rightarrow H^1(\tilde{Z}^{s-1}) \rightarrow 0,$$

and hence, by formula (12) of the preceding subsection

$$H^1(\tilde{Z}^{s-1}) \simeq \Gamma(\tilde{Z}^s) / \text{im } \Gamma(\tilde{\mathcal{F}}^{s-1}) = \tilde{H}^s(M). \quad (6)$$

From (5) we also obtain for  $r \geq 1$  and  $s \geq 1$  that

$$0 \rightarrow H^r(\tilde{Z}^s) \rightarrow H^{r+1}(\tilde{Z}^{s-1}) \rightarrow 0,$$

from which it follows (using formula (9) of the preceding subsection) that

$$H^r(\tilde{Z}^s) \simeq H^{r+1}(\tilde{Z}^{s-1}). \quad (7)$$

Using (6) and (7) we successively conclude:

$$\tilde{H}^s(M) \simeq H^1(\tilde{Z}^{s-1}) \simeq H^2(\tilde{Z}^{s-2}) \simeq \dots \simeq H^s(\tilde{Z}^0).$$

It remains to notice that  $\tilde{Z}^0$  is the sheaf of germs of smooth complex-valued functions  $f$  for which  $\bar{\partial}f = 0$ , i.e., the sheaf  $\mathcal{O}$  of germs of holomorphic functions on  $M$ . ►

A combination of (1) and (3) gives

**COROLLARY.** *For any Stein manifold*

$$H^s(M, \mathcal{O}) = 0 \quad \text{for } s \geq 1. \quad (8)$$

Now it is not difficult to give the proof of the solvability of the localized variant of the first Cousin problem.



**THEOREM 2 (H. Cartan).** *For any Stein manifold  $M$  any first Cousin problem is solvable.*

◀ Consider the following sequence of sheaves of abelian groups over  $M$  :

$$0 \xrightarrow{i} \mathcal{O} \xrightarrow{i} \mathcal{M} \xrightarrow{\varphi} \mathcal{M}/\mathcal{O} \rightarrow 0, \quad (9)$$

where  $i$  is the inclusion and  $\varphi$  is the natural homomorphism which to each germ  $\mathbf{f} \in \mathcal{O}$  associates the class in  $\mathcal{M}/\mathcal{O}$  that contains  $\mathbf{f}$ . This sequence is exact, since  $\ker \varphi = \text{im } i = 0$  and  $\text{im } \varphi = \mathcal{M}/\mathcal{O}$ . By Theorem I of the preceding subsection the sequence

$$H^0(M, \mathcal{M}) \xrightarrow{\varphi_*} H^0(M, \mathcal{M}/\mathcal{O}) \rightarrow H^1(M, \mathcal{O})$$

is also exact, and, since  $M$  is Stein,  $H^1(M, \mathcal{O}) = 0$ , and hence the mapping

$$\varphi_*: \Gamma(M, \mathcal{M}) \rightarrow \Gamma(M, \mathcal{M}/\mathcal{O})$$

is surjective, i.e., to every section of the sheaf  $\mathcal{M}/\mathcal{O}$  there corresponds a meromorphic function  $f \in \Gamma(M, \mathcal{M})$ . But this means that the problem is solvable. ▶

Thus, the first Cousin problem (in the localized form or for coverings) is solvable for all Stein manifolds and, in particular, for all domains of holomorphy in  $\mathbb{C}^n$ .

It turns out that in  $\mathbb{C}^2$  the class of domains for which this problem is solvable is also exhausted by the domains of holomorphy.

**THEOREM 3.** *If any first Cousin problem is solvable in a domain  $D \subset \mathbb{C}^2$ , then  $D$  is a domain of holomorphy.*

◀ If  $D$  is not a domain of holomorphy, then there is a ball  $B$  with center at a boundary point  $\zeta \in \partial D$ , in which all functions  $f \in \mathcal{O}(D)$  are analytically continued. Take some point  $z \in D \cap B$  and on the segment  $z\zeta$  choose a point  $\zeta^0 \in \partial D$  close to  $z$ . Without loss of generality we may assume that  $\zeta^0 = 0$  and that the line  $\{z_2 = 0\}$  contains the segment  $z\zeta^0 \subset D \cap B$ . Using the fact that the Cousin problem is solvable in  $D$ , we now construct a function  $g \in \mathcal{O}(D)$ , not analytically continuable into the ball  $B$ , and thus we are led to a contradiction.

The function  $g$  is constructed as in the example of subsection 44. Take domains  $U_1$  and  $U_2$  as in this example, and consider compatible Cousin data:  $f_1 = 1/(z_1 z_2)$  in  $D \cap U_1$  and  $f_2 \equiv 0$  in  $D \cap U_2$ . If  $f$  is a solution of this problem, then the function  $g = z_2 f$  is holomorphic in  $D$ . But the domain  $D \cap \{z_2 = 0\}$ , where  $g = 1/z_1$ , contains the segment  $[0, z] \subset B$ , and hence,  $g$  is not analytically continuable into  $B$ . ▶

This theorem does not extend to  $\mathbb{C}^n$ ,  $n \geq 3$ .

**EXAMPLE.** Consider the domain  $D \subset \mathbb{C}^3$  that is obtained from the unit polydisc  $U$  after removing the set  $\{z : |z_1| \leq 1/2, |z_2| \leq 1/2, |z_3| \geq 1/2\}$ ; in other words,  $D$  is a polydisc for which the edge  $|z_3| = 1$  has been pushed inside, as in Figure 46.

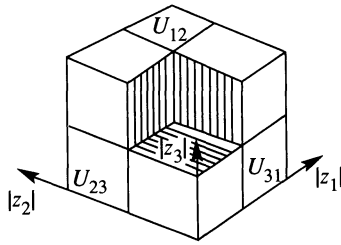

FIGURE 46

We cover  $D$  by three domains of holomorphy:

$$\begin{aligned} U_1 &= \{z : 1/2 < |z_1| < 1, |z_2| < 1, |z_3| < 1\}, \\ U_2 &= \{z : |z_1| < 1, 1/2 < |z_2| < 1, |z_3| < 1\}, \\ U_3 &= \{z : |z_1| < 1, |z_2| < 1, |z_3| < 1/2\} \end{aligned} \tag{10}$$

and consider the corresponding holomorphic cocycle  $\{h_{\alpha\beta}\}$ . Expand  $h_{\alpha\beta}$  in a Laurent series in the domain  $U_{123}$ . Since this expansion converges in  $U_{\alpha\beta}$ , we will obtain that the principal parts of the expansions  $h_{23}$  and  $h_{31}$  coincide respectively with the principal parts of the Laurent series expansions of these functions with respect to  $z_2$  and  $z_1$ . Thus, we will obtain from the equality

$$h_{12} + h_{23} + h_{31} = 0 \tag{11}$$

in  $U_{123}$  that the principal part of the Laurent series of the function  $h_{12}$  splits into two parts, one of which is holomorphic with respect to  $z_1$  and therefore extends into  $U_1$ , and the other is holomorphic with respect to  $z_2$  and extends into  $U_2$ . But it then follows from the equality (11) that the principal parts of the Laurent expansions for the functions  $h_{23}$  and  $h_{31}$  respectively extend into  $U_2$  and  $U_1$ . Analogously we will obtain that the regular parts of these functions also extend into the corresponding domains. We denote by  $h_1$  the extension of  $h_{31}$  into  $U_1$ , by  $h_2$  the extension of  $h_{32}$  into  $U_2$  and we set  $h_3 = 0$  in  $U_3$ . Then

$$h_2 - h_1 = h_{32} - h_{31} = h_{12} \quad \text{in } U_{12},$$

and thus  $\{h_{\alpha\beta}\}$  is a coboundary of the cochain  $\{h_\alpha\}$ , i.e., the first Cousin problem is solvable for the covering (10). From what we have indicated it is not difficult to conclude that the Cousin problem in the localized variant is also solvable in  $D$ . It remains to note that  $D$  itself is not a domain of holomorphy, since it is not a logarithmically convex Reinhardt domain.

**49. Second Cousin problem.** This problem generalizes the problem of constructing a holomorphic function from given zeros, which is solved in the case of one variable by the theorem of Weierstrass (subsection 46 of Part I). It is called the *second* or *multiplicative Cousin problem* for coverings and is stated as follows:

Given a covering  $\mathcal{U} = \{U_\alpha\}_{\alpha \in A}$  of a complex manifold  $M$  and a function  $f_\alpha \in \Gamma(U_\alpha, \mathcal{M}^*)$  in each  $U_\alpha$ , i.e., a meromorphic function that is not identically equal to zero, where the following COMPATIBILITY CONDITION holds: in any intersection  $U_{\alpha\beta} = U_\alpha \cap U_\beta$  the quotient  $f_\alpha/f_\beta \in \Gamma(U_{\alpha\beta}, \mathcal{O}^*)$ , i.e., is a nonvanishing holomorphic function, we have to construct a meromorphic function  $f$  on the manifold  $M$  such that  $f/f_\alpha \in \Gamma(U_\alpha, \mathcal{O}^*)$  for all  $\alpha \in A$ .

A function  $f$  that solves the problem consequently has in each  $U_\alpha$  the same zeros and poles (including multiplicities) as the given meromorphic functions  $f_\alpha$ . The localized variant of the problem is stated as follows:

for a given section of the sheaf  $\mathcal{M}^*/\mathcal{O}^*$  (with compatible data) find the corresponding section of the sheaf  $\mathcal{M}$  on the whole manifold.

We give yet another formulation of the second Cousin problem. In subsection 43 we introduced the concept of the divisor of a given meromorphic function. More generally, we now call a *divisor* on a manifold  $M$  a pair  $\Delta = (A, k)$ , consisting of an analytic set  $A$  of codimension 1 (the *support* of the divisor) and an integer-valued function  $k$  (the *order* of the divisor) that is continuous on the set  $A^0$  of regular points of  $A$ . A divisor is said to be *positive* if  $k > 0$  everywhere, and *negative* if  $k < 0$  everywhere (cf. subsection 43). If we agree to set  $k(p) \equiv 0$  for  $p \in M \setminus A^0$ , then one can introduce the concept of the sum (or difference) of the divisors  $\Delta_1 = (A_1, k_1)$  and  $\Delta_2 = (A_2, k_2)$  as the divisor  $\Delta_1 \pm \Delta_2 = (A_1 \cup A_2, k_1 \pm k_2)$ . We will say that  $\Delta_1 = \Delta_2$  if  $\Delta_1 - \Delta_2$  has order  $k \equiv 0$ .

A divisor  $\Delta$  is said to be *proper* if there exists a meromorphic function  $f$  on  $M$  such that  $\Delta = \Delta_f$ , i.e., it is the divisor of this function (see subsection 43). In any planar domain  $D \neq \mathbb{C}$  every divisor is proper, which follows from the theorems of Weierstrass and Mittag-Leffler from Part I. But this is already not so for  $\overline{\mathbb{C}}$ : the divisor  $(\infty, 1)$  is not proper, since there does not exist a holomorphic function in  $\overline{\mathbb{C}}$  that has a first-order zero at infinity (all such functions are constant). In  $\mathbb{C}^2$  there also exist domains for which this is not so.

**EXAMPLE.** Let  $D$  be  $\mathbb{C}^2$  with a deleted circle  $\gamma = \{|z_1| = 1, z_2 = 0\}$ . Consider the divisor  $\Delta = (\{z_2 = 0\}, k)$ , where  $k = 0$  if  $|z_1| < 1$  and  $k = 1$  if  $|z_1| > 1$ . It is nonnegative, so that it could only correspond to a function that is holomorphic in  $D = \mathbb{C}^2 \setminus \gamma$ . By the theorem on compact singularities this function would extend to an entire function, but then its restriction to  $\{z_2 = 0\}$  could not equal 0 inside of  $\gamma$  and be different from zero outside of  $\gamma$ . Consequently,  $\Delta$  is not a proper divisor.

**THEOREM 1.** *The second Cousin problem for any covering  $\mathcal{U} = \{U_\alpha\}_{\alpha \in A}$  of a complex manifold  $M$  is solvable if and only if any divisor on this manifold is proper.*

◀ (a) Suppose that any divisor on  $M$  is proper and let  $\{f_\alpha\}$  be arbitrary data for the second Cousin problem for the covering  $\mathcal{U}$ . Let  $\Delta_{f_\alpha} = (A_\alpha, k_\alpha)$  be the divisor of the function  $f_\alpha$ ; since  $f_\alpha/f_\beta \in \mathcal{O}^*(U_{\alpha\beta})$  for any intersection  $U_{\alpha\beta}$ , then  $A_\alpha = A_\beta$  and  $k_\alpha = k_\beta$  in this intersection. Consequently,  $A = \bigcup_{\alpha \in A} A_\alpha$  is an analytic subset of  $M$  of codimension 1 and  $k = k_\alpha$  in  $U_\alpha$  is a globally defined integer-valued function on  $A^0$ , i.e.,  $(A, k) = \Delta$  is a divisor on  $M$ .

Take a function  $f \in \mathcal{M}(M)$  for which  $\Delta_f = \Delta$ . Then for any  $\alpha \in A$   $f/f_\alpha$  is holomorphic and different from zero in  $U_\alpha \setminus A_\alpha$  and at the regular points of  $A_\alpha$ , and since the codimension of the set of critical points of  $A_\alpha$  is not less than 2, then by Theorem 2 of subsection 32,  $f/f_\alpha$  extends to a function from  $\mathcal{O}(U_\alpha)$  that is obviously nonvanishing. Consequently,  $f$  solves the problem for the data  $\{f_\alpha\}$ .

(b) Suppose the problem is solvable on  $M$  and let  $\Delta = (A, k)$  be an arbitrary divisor. Since  $\text{codim } A = 1$ , then for any  $\alpha \in A$  there is a finite number of functions  $h_{\alpha_j} \in \mathcal{O}(U_\alpha)$  such that

$$A \cap U_\alpha = \bigcup_j \{h_{\alpha_j} = 0\}.$$

Without loss of generality we may assume that the  $A_{\alpha_j} = \{h_{\alpha_j} = 0\}$  are irreducible sets and the  $h_{\alpha_j}$  are irreducible functions (cf. subsection 24). The order  $k$  is constant on the set of regular points of  $A_{\alpha_j}$ ; suppose that it is equal to  $k_{\alpha_j}$  there. We set  $f_\alpha = \prod_j (h_{\alpha_j})^{k_{\alpha_j}}$  for all the  $\alpha$  for which  $U_\alpha \cap A \neq \emptyset$  and  $f_\alpha \equiv 1$  for the remaining  $\alpha$ . These are compatible data for the second Cousin problem and, by hypothesis, there is a function  $f \in \mathcal{M}(M)$  that solves this problem. By construction  $\Delta_f = \Delta$ . ►

Thus, the second Cousin problem for coverings turns out to be equivalent to the problem of constructing a meromorphic function from a given divisor. The situation is also analogous for the localized formulation. In this formulation the compatible data of the problem can be treated as a section on  $M$  of the sheaf  $\mathcal{D} = \mathcal{M}^* / \mathcal{O}^*$ , which is called the *sheaf of germs of divisors*, and the problem leads to finding a function  $f \in \Gamma(M, \mathcal{M}^*)$  that corresponds to this section.

We pass to questions of solvability. If we have data  $\{f_\alpha\}$  for the second Cousin problem for a covering  $\mathcal{U} = \{U_\alpha\}$  of the manifold  $M$ , in each intersection  $U_{\alpha\beta} = U_\alpha \cap U_\beta$  we can consider the quotients

$$h_{\alpha\beta} = \frac{f_\alpha}{f_\beta} \in \Gamma(U_{\alpha\beta}, \mathcal{O}^*). \quad (1)$$

The functions  $h_{\alpha\beta}$  satisfy the conditions

$$h_{\alpha\beta} h_{\beta\alpha} = 1, \quad h_{\alpha\beta} h_{\beta\gamma} h_{\gamma\alpha} = 1, \quad (2)$$

which form a multiplicative analogue of the conditions from subsection 44 defining a holomorphic cocycle, and we shall call the set of them for a given covering  $\mathcal{U}$  a *multiplicative cocycle*. If  $\{h'_{\alpha\beta}\}$  and  $\{h''_{\alpha\beta}\}$  are two such cocycles, then their product, i.e., the set of functions  $h_{\alpha\beta} = h'_{\alpha\beta} h''_{\alpha\beta}$ , is also a multiplicative cocycle. These cocycles form a group, which is denoted by the symbol  $Z^1(\mathcal{U}, \mathcal{O}^*)$ .

As in subsection 44, the second Cousin problem turns out to be solvable if and only if there exist functions  $h_\alpha \in \Gamma(U_\alpha, \mathcal{M}^*)$  such that in each  $U_{\alpha\beta}$  we have

$$h_{\alpha\beta} = h_\beta / h_\alpha. \quad (3)$$

The set of such  $\{h_{\alpha\beta}\}$  is called a *multiplicative coboundary*; these sets form a subgroup of  $Z^1(\mathcal{U}, \mathcal{O}^*)$ , which is denoted by the symbol  $B^1(\mathcal{U}, \mathcal{O}^*)$ . The

quotient group

$$H^1(\mathcal{U}, \mathcal{O}^*) = Z^1(\mathcal{U}, \mathcal{O}^*) / B^1(\mathcal{U}, \mathcal{O}^*) \quad (4)$$

is called the *first cohomology group for the covering  $\mathcal{U}$  with coefficients in the sheaf  $\mathcal{O}^*$* ; the group operation here, as in  $\mathcal{O}^*$ , is multiplication, instead of addition acting in  $H^1(\mathcal{U}, \mathcal{O})$ . The triviality of  $H^1(\mathcal{U}, \mathcal{O}^*)$  obviously implies the solvability of any second Cousin problem for the covering  $\mathcal{U}$ .

There is a natural desire to reduce the second Cousin problem to the first by taking logarithms. Since the functions  $h_{\alpha\beta}$  are holomorphic and different from zero, then, assuming that the intersections  $U_{\alpha\beta}$  are simply connected, we can choose some holomorphic branch  $\ln h_{\alpha\beta} = g_{\alpha\beta}$  in each of them, and also, in view of the first condition of (2), so that  $g_{\alpha\beta} + g_{\beta\alpha} = 0$ . From the second condition of (2) we then obtain that

$$g_{\alpha\beta} + g_{\beta\gamma} + g_{\gamma\alpha} = 2\pi i k_{\alpha\beta\gamma}$$

in the intersections  $U_{\alpha\beta\gamma}$ , where  $k_{\alpha\beta\gamma}$  are integers. If all these numbers are equal to zero, we arrive at the first Cousin problem, and, solving it, we obtain a solution of the second problem. In general, however, this is not so and, besides the conditions for the solvability of the first Cousin problem, it is necessary to impose another topological restriction on  $M$ , which should ensure the possibility of choosing branches  $\ln h_{\alpha\beta} = g_{\alpha\beta}$  so that all the  $k_{\alpha\beta\gamma}$  turn out to be equal to zero.

This restriction is expressed by the condition that the second cohomology group with integer coefficients be trivial for a given covering  $\mathcal{U}$ , which is denoted by the symbol  $H^2(\mathcal{U}, \mathbb{Z})$  according to the system given in subsection 46. This means that any integer cocycle of second order, i.e., integer-valued function of three indices  $k_{\alpha\beta\gamma}$ , which is anti-symmetric with respect to the indices, and which satisfies the condition  $k_{\beta\gamma\delta} - k_{\alpha\gamma\delta} + k_{\alpha\beta\delta} - k_{\alpha\beta\gamma} = 0$  on quadruple intersections  $U_{\alpha\beta\gamma\delta}$ , is represented in the form

$$k_{\alpha\beta\gamma} = k_{\beta\gamma} - k_{\alpha\gamma} + k_{\alpha\beta}, \quad (5)$$

where  $k_{\alpha\beta}, \dots$  are integers.

**THEOREM 2 (Serre).** *Let  $\mathcal{U} = \{U_\alpha\}$  be a simple covering of a complex manifold  $M$ , i.e., all the intersections  $U_{\alpha\beta}$  are connected and simply connected. If*

$$H^1(\mathcal{U}, \mathcal{O}) = H^2(\mathcal{U}, \mathbb{Z}) = 0 \quad (6)$$

*for this covering, then any second Cousin problem is solvable for it.*

◀ Let  $\{h_{\alpha\beta}\} \in Z^1(\mathcal{U}, \mathcal{O}^*)$  be a multiplicative cocycle corresponding to the data  $\{f_\alpha\}$  of the second Cousin problem according to formula (1). Since the intersections are simply connected, it is possible to choose holomorphic branches  $g'_{\alpha\beta} = \ln h_{\alpha\beta}$ , making them compatible in such a way that for all  $\alpha, \beta$  we would have  $\ln h_{\beta\alpha} = -\ln h_{\alpha\beta}$ .

In the triple intersections we obtain

$$g'_{\alpha\beta} + g'_{\beta\gamma} + g'_{\gamma\alpha} = 2\pi i k_{\alpha\beta\gamma}, \tag{7}$$

where  $\{k_{\alpha\beta\gamma}\}$  is an integer cocycle from  $Z^2(\mathcal{U}, \mathbb{Z})$ . By hypothesis  $H^2(\mathcal{U}, \mathbb{Z}) = 0$ , and hence, we can represent this cocycle in the form (5) and in  $U_{\alpha\beta}$  we can set

$$g_{\alpha\beta} = g'_{\alpha\beta} - 2\pi i k_{\alpha\beta}.$$

Then in each triple intersection  $U_{\alpha\beta\gamma}$  we will have in view of (7) and (5)

$$g_{\alpha\beta} + g_{\beta\gamma} + g_{\gamma\alpha} = 2\pi i k_{\alpha\beta\gamma} - 2\pi i (k_{\alpha\beta} + k_{\beta\gamma} + k_{\gamma\alpha}) = 0.$$

Thus,  $\{g_{\alpha\beta}\}$  is a holomorphic cocycle from  $Z^1(\mathcal{U}, \mathcal{O})$ . By the hypothesis of the theorem  $H^1(\mathcal{U}, \mathcal{O}) = 0$ , and hence it is a coboundary, i.e., there exist  $g_\alpha \in \mathcal{O}(U_\alpha)$  such that  $g_{\alpha\beta} = g_\beta - g_\alpha$ . We set  $h_\alpha = e^{g_\alpha}$ ; then  $h_\alpha \in \mathcal{O}^*(U_\alpha)$  and  $h_{\alpha\beta} = e^{g'_{\alpha\beta}} = e^{g_{\alpha\beta}} = h_\beta/h_\alpha$ . This means that  $\{h_{\alpha\beta}\} \in B^1(\mathcal{U}, \mathcal{O}^*)$ ; we have proved that  $H^1(\mathcal{U}, \mathcal{O}^*) = 0$  and, hence, the problem is solvable. ►

Passing to the localized problem we shall find that, as is proved in topology, the integer cohomology is invariant relative to homotopic transformations of the spaces (this reflects their topological nature). Recall that two continuous mappings  $f, g: X \rightarrow Y$  of topological spaces are said to be *homotopic* if there exists a family of continuous mappings  $f_t: X \rightarrow Y$ , depending continuously on a parameter  $t \in [0, 1]$  and such that  $f_0 = f, f_1 = g$  (cf. the definition of a homotopy of paths in subsection 21). Two spaces are said to be homotopic if there exist continuous mappings  $f: X \rightarrow Y$  and  $g: Y \rightarrow X$  such that  $g \circ f$  is homotopic to the identity mapping of  $X$  and  $f \circ g$  is homotopic to the identity mapping of  $Y$ .

\* Prove that:

1. The ball  $B^n = \{z \in \mathbb{C}^n : |z| < 1\}$  is homotopic to a point, and the solid annulus  $\{z \in \mathbb{C}^n : r < |z| < R\}$  is homotopic to the sphere  $\{|z| = 1\}$ .
2. For the ball  $H^s(B^n, \mathbb{Z}) = 0$  for all  $s > 0$ , and for the  $n$ -dimensional sphere  $H^s(S^n, \mathbb{Z}) = 0$  for  $0 < s < n$ , but  $H^n(S^n, \mathbb{Z}) = \mathbb{Z}$ .
3. If  $H^s(M, \mathbb{Z}) = 0$  for a manifold  $M$ , then  $H^s(\mathcal{U}, \mathbb{Z}) = 0$  for any simple covering  $\mathcal{U}$  of  $M$ . \*

We now give a localized variant of Theorem 2:

**THEOREM 3 (Serre).** *On a Stein manifold  $M$  any second Cousin problem is solvable, if the second cohomology group of  $M$  with integer coefficients is trivial:*

$$H^2(M, \mathbb{Z}) = 0. \tag{8}$$

◄ Consider the exact sequence of sheaves of multiplicative groups

$$1 \rightarrow \mathcal{O}^* \xrightarrow{i} \mathcal{M}^* \xrightarrow{\varphi} \mathcal{M}^*/\mathcal{O}^* \rightarrow 1,$$

where  $i$  is the inclusion and  $\varphi$  is the natural homomorphism (exactness follows from the fact that  $\text{im } i = \ker \varphi$  and  $\text{im } \varphi = \mathcal{M}^*/\mathcal{O}^*$ ). To it corresponds

the exact sequence

$$\Gamma(M, \mathcal{M}^*) \rightarrow \Gamma(M, \mathcal{M}^*/\mathcal{O}^*) \rightarrow H^1(M, \mathcal{O}^*). \tag{9}$$

The condition for the solvability of the problem under consideration is that the mapping

$$\varphi_*: \Gamma(M, \mathcal{M}^*) \rightarrow \Gamma(M, \mathcal{M}^*/\mathcal{O}^*)$$

be surjective. Since the sequence (9) is exact, then this condition reduces to the condition

$$H^1(M, \mathcal{O}^*) = 0. \tag{10}$$

We give this condition another form. For this we consider one more exact sequence

$$0 \rightarrow \mathbb{Z} \xrightarrow{i} \mathcal{O} \xrightarrow{e} \mathcal{O}^* \rightarrow 1, \tag{11}$$

where  $i$  is the inclusion homomorphism and  $e: f \rightarrow e^{2\pi i f}$  is a homomorphism from the sheaf  $\mathcal{O}$  of additive groups into the sheaf  $\mathcal{O}^*$  of multiplicative groups.<sup>(9)</sup> The corresponding sequence

$$H^1(M, \mathcal{O}) \rightarrow H^1(M, \mathcal{O}^*) \rightarrow H^2(M, \mathbb{Z}) \rightarrow H^2(M, \mathcal{O})$$

is also exact, and since  $M$  is a Stein manifold, then the groups at the ends here are trivial. From this it follows that the two groups in the middle are isomorphic, and in view of condition (8) the equality (10) actually holds. ►

REMARK. We see from the proof that in order to solve a concrete second problem corresponding to some section of  $\Gamma(M, \mathcal{M}^*/\mathcal{O}^*)$  it is necessary and sufficient that the image of this section under the homomorphism

$$\sigma: \Gamma(M, \mathcal{M}^*/\mathcal{O}^*) \rightarrow H^1(M, \mathcal{O}^*)$$

be the identity element of the group  $H^1(M, \mathcal{O}^*)$ . Serre also proved that for Stein manifolds the homomorphism  $\sigma$  is always surjective (moreover, for any element  $g \in H^1(M, \mathcal{O}^*)$  there is a corresponding element  $f \in \Gamma(M, \mathcal{M}^*/\mathcal{O}^*)$  that consists only of germs of HOLOMORPHIC functions). Thus, if  $H^1(M, \mathcal{O}^*) \neq 0$ , then there is a section from  $\Gamma(M, \mathcal{M}^*/\mathcal{O}^*)$  for which the problem is not solvable, i.e., for Stein manifolds condition (8) is also NECESSARY for the solvability of an arbitrary second Cousin problem.

EXAMPLES. There exist manifolds which are not Stein, although the second Cousin problem is solvable on them. An example is the domain  $D = \{0 < |z_1| < 1; |z_2| < 1\} \cup \{z_1 = 0, |z_2| < 1/2\}$  in the space  $\mathbb{C}^2$ ; it is not a domain of holomorphy, but one can prove that any second Cousin problem in it is solvable. From Theorem 3 of the preceding subsection we see that  $D$  is also an example of a domain in which the second Cousin problem is solvable, but the first problem is not. In the domain  $D \subset \mathbb{C}^3$  of the example of the previous subsection both the first and second Cousin problems are solvable, although  $D$  itself is not a domain of holomorphy. The solvability of the second problem follows from the fact that  $H^1(D, \mathcal{O}) = 0$  while  $H^2(D, \mathbb{Z}) = 0$ , since  $D$  is homeomorphic to the ball.

<sup>(9)</sup>The exactness of the sequence (11) is clear from the fact that functions that are identically equal to integers are mapped to 1 under the mapping  $e$  and that every function  $f \neq 0$  is LOCALLY represented in the form  $e^{2\pi i g}$ , i.e., the mapping  $e: \mathcal{O} \rightarrow \mathcal{O}^*$  is surjective.

A simple consequence of Serre's theorem is

**THEOREM 4 (Oka).** *If  $D = D_1 \times \cdots \times D_n$  is a polycircular domain in  $\mathbb{C}^n$  for which all the domains  $D_\nu$ , except perhaps one, are simply connected, then any second Cousin problem is solvable in  $D$ .*

◀ First of all,  $D$  is obviously a domain of holomorphy. Suppose  $D_2, \dots, D_n$  are simply connected domains; then  $H^2(D, \mathbb{Z}) = H^2(D_1, \mathbb{Z})$ , since cohomology groups with integer coefficients do not change when we take the Cartesian product of the space with a simply connected planar domain (we shall not go into the proof of this topological fact). But for any planar domain  $D_1$  the group  $H^2(D_1, \mathbb{Z})$  is trivial (this follows at least from the theorem of Weierstrass of subsection 46 of Part I); therefore  $H^2(D, \mathbb{Z}) = 0$ . ▶

**EXAMPLE.** From Theorem 4 it follows in particular that the second Cousin problem is solvable in any simply connected polycircular domain. But for arbitrary domains of holomorphy simple-connectedness alone does not ensure the solvability of this problem; here is an example (due to Serre). The domain

$$D = \{z \in \mathbb{C}^3 : |z_1^2 + z_2^2 + z_3^2 - 1| < 1\}$$

is a domain of holomorphy, since at each point  $\zeta \in \partial D$  there exists a barrier: the function  $f_\zeta(z) = \{\zeta_1^2 + \zeta_2^2 + \zeta_3^2 - (z_1^2 + z_2^2 + z_3^2)\}^{-1} \in \mathcal{O}(D)$  is not bounded as  $z \rightarrow \zeta$ . The domain is simply connected, since it is homeomorphic to the product of the surface  $M = \{z_1^2 + z_2^2 + z_3^2 - 1 = 0\}$  by the unit disc. Nevertheless, not every second Cousin problem is solvable in  $D$ . In fact, the domain  $D$  is homotopic to the surface  $M$ , and the latter is homotopic to the two-dimensional sphere  $\{x \in \mathbb{R}^3 : x_1^2 + x_2^2 + x_3^2 - 1 = 0\}$  (prove this!), and therefore  $H^2(D, \mathbb{Z}) = H^2(S^2, \mathbb{Z}) \neq 0$ .

## §17. Applications

We consider some applications of the results obtained in the previous section.

**50. Applications of the Cousin problems.** As a first application we consider the problem of the holomorphic extension of functions from analytic subsets of Stein manifolds  $M$ .

**THEOREM 1.** *Let  $M$  be a Stein manifold and let*

$$A = \{p \in M : \varphi(p) = 0\} \tag{1}$$

*be an analytic set of codimension 1, for which  $\varphi \in \mathcal{O}(M)$  is the defining function.<sup>(10)</sup> Then any function  $f$  that is locally holomorphic at the points of  $A$  extends to  $\tilde{f} \in \mathcal{O}(M)$ .*

◀ Since  $f$  is locally holomorphic at the points of  $A$ , there is an open covering  $\{U_\alpha\}$  of the manifold  $M$  that is so fine that for any  $\alpha$  for which  $U_\alpha \cap A \neq \emptyset$ , there exists a function  $f_\alpha \in \mathcal{O}(U_\alpha)$ , satisfying the condition

$$f_\alpha|_{U_\alpha \cap A} = f|_{U_\alpha \cap A}. \tag{2}$$

In the remaining  $U_\alpha$  we set  $f_\alpha \equiv 0$  and we take the collection of functions

<sup>(10)</sup>See subsection 25.



$f_\alpha/\varphi \in \mathcal{M}(U_\alpha)$  as data for the first Cousin problem for the covering  $\{U_\alpha\}$ .

Since in any intersection  $U_{\alpha\beta} = U_\alpha \cap U_\beta$  the difference  $f_\alpha - f_\beta$  vanishes on  $A$  in view of (2), then by the property of  $\varphi$  being a defining function there are functions  $h_{\alpha\beta} \in \mathcal{O}(U_{\alpha\beta})$  such that  $f_\alpha - f_\beta = h_{\alpha\beta}\varphi$ . From this we see that the data under consideration are compatible and

$$h_{\alpha\beta} = \frac{f_\alpha - f_\beta}{\varphi} \quad (3)$$

is the holomorphic cocycle corresponding to the problem. By Theorem 2 of subsection 48 this problem is solvable, i.e., there exist functions  $h_\alpha \in \mathcal{O}(U_\alpha)$  such that  $h_{\alpha\beta} = h_\beta - h_\alpha$ . Comparing this with (3), we find that  $f_\alpha + \varphi h_\alpha = h_\beta + \varphi h_\beta$  in any intersection  $U_{\alpha\beta}$ . Thus, on  $M$  there is a globally defined holomorphic function  $\tilde{f}$  such that  $\tilde{f}|_{U_\alpha} = f_\alpha + \varphi h_\alpha$  for any  $\alpha$ . Since  $\varphi = 0$  on  $A$ , it follows that  $\tilde{f}|_A = f$ . ▶

\* Let  $M = \{z \in \mathbb{C}^2 : 1 < |z| < 2\}$  and  $A = \{z \in M : z_2 = 0\}$ ; prove that the function  $f(z) = 1/(z_1 - 1)$ , which is holomorphic in  $A$ , does not extend holomorphically into  $M$ . Why is Theorem 1 not applicable here? \*

Theorem 1 allows us to obtain the Hefer expansion, which we applied without proof in subsection 30 in the derivation of Weil's integral formula. The basis of this is the following:

LEMMA. Let  $D \subset \mathbb{C}^n$  be a domain of holomorphy and suppose that the  $(n - k)$ -dimensional complex plane  $\Pi = \{z \in \mathbb{C}^n : z_1 = \dots = z_k = 0\}$  has nonempty intersection with it. Then any function  $f \in \mathcal{O}(D)$ , equal to zero on  $\Pi \cap D$ , admits the representation

$$f(z) = \sum_{\nu=1}^k z_\nu g_\nu(z) \quad (4)$$

in  $D$ , where all the  $g_\nu \in \mathcal{O}(D)$ .

◀ The proof goes by induction on  $k$ . For  $k = 1$  the assertion is obvious, since we can take the function  $f/z_1$  as  $g_1$ . Suppose that it is true for  $k - 1$ . Let  $G = D \cap \{z_k = 0\}$ ; all the connected components of this intersection are obviously domains of holomorphy in the space  $\mathbb{C}^{n-1}$  with the variables  $z_1, \dots, z_{k-1}, z_{k+1}, \dots, z_n$ . The restriction  $f|_{\{z_k=0\}} \in \mathcal{O}(G)$  and by hypothesis it vanishes on  $G \cap \{z_1 = \dots = z_{k-1} = 0\}$ . From this, by the induction hypothesis, it follows that we have the representation

$$f|_{\{z_k=0\}} = \sum_{\nu=1}^{k-1} z_\nu g_\nu^0(z_1, \dots, z_{k-1}, z_{k+1}, \dots, z_n)$$

in  $G$ , where all the  $g_\nu^0 \in \mathcal{O}(G)$ . By Theorem 1 all the  $g_\nu^0$  extend from  $G = D \cap \{z_k = 0\}$  into the whole domain  $D$  to holomorphic functions  $g_\nu(z)$ .

We now consider the difference

$$\varphi(z) = f(z) - \sum_{\nu=1}^{k-1} z_{\nu} g_{\nu}(z);$$

obviously  $\varphi|_{\{z_k=0\}} = 0$ , and, since  $z_k$  is a defining function, then there is a  $g_k \in \mathcal{O}(D)$  such that  $\varphi(z) = z_k g_k(z)$  for all  $z \in D$ . From this we see that the representation (4) holds for all  $k$ . ►

From this lemma we can rather simply derive the following theorem.

**THEOREM 2 (Hefer).** *Let  $D \subset \mathbb{C}^n$  be a domain of holomorphy and  $W(z) \in \mathcal{O}(D)$  an arbitrary function. There exist functions  $P_{\nu}(\zeta, z) \in \mathcal{O}(D \times D)$ ,  $\nu = 1, \dots, n$ , such that, for all  $\zeta, z \in D$  the following representation holds:*

$$W(\zeta) - W(z) = \sum_{\nu=1}^n (\zeta_{\nu} - z_{\nu}) P_{\nu}(\zeta, z). \quad (5)$$

◀ The difference  $W(\zeta) - W(z) \in \mathcal{O}(D \times D)$ , and since  $D \times D$  is a domain of holomorphy in  $\mathbb{C}^{2n}$ , and since this difference vanishes on the  $n$ -dimensional complex plane  $\Pi = \{z, \zeta : z_{\nu} = \zeta_{\nu}, \nu = 1, \dots, n\}$ , then, setting  $Z_{\nu} = \zeta_{\nu} - z_{\nu}$ ,  $Z_{n+\nu} = z_{\nu}$  ( $\nu = 1, \dots, n$ ), we can apply the lemma to this difference. We obtain the desired expansion (5). ►

Theorem 1 admits a sharpening. In it it is assumed that the set  $A$  has a defining function that is globally holomorphic on the whole manifold  $M$ ; we shall now show that for certain manifolds  $M$  this assumption holds automatically.

**THEOREM 3.** *For a complex manifold  $M$  suppose that*

$$H^1(M, \mathcal{O}) = H^2(M, \mathbb{Z}) = 0. \quad (6)$$

*Then for any analytic subset  $A \subset M$  of codimension 1 there exists a global defining function  $\varphi \in \mathcal{O}(M)$ .*

◀ Any analytic subset of codimension 1 has local defining functions (subsection 25). Therefore there exists a covering  $\mathcal{U} = \{U_{\alpha}\}$  of the manifold  $M$  that is so fine that in any  $U_{\alpha}$  for which  $U_{\alpha} \cap A \neq \emptyset$ , there is a function  $\varphi_{\alpha} \in \mathcal{O}(U_{\alpha})$  that is a defining function for the set  $U_{\alpha} \cap A$ ; in the remaining  $U_{\alpha}$  we set  $\varphi_{\alpha} \equiv 1$ . Without loss of generality the covering  $\mathcal{U}$  can be assumed to be simple (see Theorem 2 of subsection 49) and such that<sup>(11)</sup>

$$H^1(\mathcal{U}, \mathcal{O}) = H^2(\mathcal{U}, \mathbb{Z}) = 0. \quad (7)$$

The set  $\{\varphi_{\alpha}\}$  can be considered as data for a second Cousin problem for the covering  $\mathcal{U}$ ; they are compatible data, since by the properties of defining functions in any intersection  $\varphi_{\alpha}/\varphi_{\beta} \in \mathcal{O}^*(U_{\alpha\beta})$ . By Theorem 2 of the previous subsection this problem is solvable, i.e., there exists a function  $\varphi$

<sup>(11)</sup>We use the remark at the end of subsection 46 and the exercise in subsection 49.

that is holomorphic on  $M$  (since the Cousin data are holomorphic) and such that  $\varphi/\varphi_\alpha \in \mathcal{O}^*(U_\alpha)$  in any  $U_\alpha$ . This function  $\varphi$  is also a global defining function for the set  $A$ . ►

We also give a solution to the so-called PROBLEM OF POINCARÉ : represent a meromorphic function on a manifold as a quotient of functions that are holomorphic on this manifold. (Locally such a representation follows from the definition of meromorphic functions, but the problem here concerns a GLOBAL representation.)

As in the case of one variable (see Theorem 3 of subsection 46 of Part I), it is proved that Poincaré's problem is solvable on any manifold on which the second Cousin problem is solvable. Using the result of Serre, which is formulated in the remark following Theorem 3 of the preceding subsection, one can prove that the problem is also solvable for an arbitrary Stein manifold: namely, the following holds.

**THEOREM 4.** *Each function  $f$ , meromorphic on a Stein manifold  $M$ , is represented as a quotient of functions that are holomorphic on this manifold.*

◀ We represent the divisor  $\Delta_f$  of the function  $f$  as a difference  $\Delta' - \Delta''$  of two positive divisors belonging to  $\Gamma(M, \mathcal{D})$ . We take an element  $\sigma(\Delta'') \in H^1(M, \mathcal{O}^*)$  and, using Serre's result cited above, we find a positive divisor  $\Delta'''$  such that  $\sigma(\Delta''') = -\sigma(\Delta'')$ . Since  $\sigma$  is a homomorphism, then  $\sigma(\Delta'' + \Delta''') = 0$ , and hence (by the remark following Theorem 3 of subsection 49), the corresponding Cousin problem is solvable and there exists a function  $\psi \in \Gamma(M, \mathcal{M}^*)$  whose divisor  $\Delta_\psi = \Delta'' + \Delta'''$ . But this divisor is positive, and hence the function  $\psi$  is holomorphic. Finally, we consider the divisor of the product  $\Delta_{f\psi} = (\Delta' - \Delta'') + (\Delta'' + \Delta''') = \Delta' + \Delta'''$ ; it is also positive, and hence the function  $\varphi = f\psi$  is also holomorphic on  $M$ . The given function  $f$  is equal to  $\varphi/\psi$ . ►

**51. Solution of the Levi problem.** We start with a generalization of the problem of extending functions from analytic sets, which we discussed in the previous subsection. Indeed, instead of sets of codimension 1 we consider sets of arbitrary codimension, and instead of holomorphic functions, we consider smooth forms that are closed relative to the operator  $\bar{\partial}$ .

Denote by  $X$  a closed subset of a complex manifold  $M$ , and by  $\tilde{Z}^s(X)$  the set of smooth forms of bidegree  $(0, s)$  that are defined and  $\bar{\partial}$ -closed in some neighborhood of  $X$  (each in its neighborhood). Let  $\tilde{B}^s(X) \subset \tilde{Z}^s(X)$  be the subgroup of  $\bar{\partial}$ -exact forms and let  $\tilde{H}^s(X) = \tilde{Z}^s(X)/\tilde{B}^s(X)$  be the quotient group. We need the following

**LEMMA.** *Let  $X$  be a closed subset of a complex manifold  $M$ , and suppose that the function  $\varphi$  is holomorphic in a neighborhood of  $X$  and  $A = \{p \in X: \varphi(p) = 0\}$ . If for some  $s \geq 0$  we have*

$$\tilde{H}^{s+1}(X) = 0, \tag{1}$$

then for any form  $\omega \in \tilde{Z}^s(A)$  there exists a form  $\Omega \in \tilde{Z}^s(X)$  whose restriction to  $A$ ,  $\Omega|_A = \omega$ . Moreover,

$$\tilde{H}^s(X) = 0 \Rightarrow \tilde{H}^s(A) = 0. \quad (2)$$

◀ Take any form  $\omega \in \tilde{Z}^s(A)$  and construct a function  $\eta \in C^\infty(X)$ , equal to zero outside some neighborhood of  $A$ , which together with its closure belongs to the neighborhood in which  $\omega$  is defined, and equal to one in a smaller neighborhood of  $A$ . Then the form  $\eta\omega$ , extended by zero where  $\eta = 0$ , will be smooth on the whole set  $X$ . The form  $\omega' = \frac{1}{\varphi} \bar{\partial}(\eta\omega)$  is closed in  $X \setminus A$ , since  $\varphi \neq 0$  and is holomorphic there (and hence acts like a constant under differentiation with respect to  $\bar{z}$ ).

In the neighborhood of  $A$  in which  $\eta \equiv 1$  we have  $\bar{\partial}(\eta\omega) = 0$ , since the form  $\omega$  is closed. Therefore we can extend the definition of  $\omega'$  by setting it equal to zero on  $A$ , and then we obtain that  $\omega' \in \tilde{Z}^{s+1}(X)$ . In view of condition (1), there exists a smooth form  $\Omega'$  on  $X$ , for which  $\bar{\partial}\Omega' = \omega'$ . From this it follows that

$$\bar{\partial}(\eta\omega - \varphi\Omega') = 0$$

on  $X$ , i.e., the form  $\Omega = \eta\omega - \varphi\Omega' \in \tilde{Z}^s(X)$ . Since on  $A$  the function  $\varphi = 0$  and  $\eta = 1$ , then the restriction  $\Omega|_A = \omega$ , and the first assertion of the lemma is proved.

If in addition  $\tilde{H}^s(X) = 0$ , then the form  $\Omega$  is exact in  $X$ , and hence,  $\omega$  is exact on  $A$ . Since  $\omega \in \tilde{Z}^s(A)$  is arbitrary, then  $\tilde{H}^s(A) = 0$ . ▶

Now it is not difficult to prove a general extension theorem.

**THEOREM 1.** *Let  $M$  be a complex manifold and let*

$$A = \{p \in M : \varphi_1(p) = \dots = \varphi_m(p) = 0\}, \quad (3)$$

where all the  $\varphi_j \in \mathcal{O}(M)$ . If

$$\tilde{H}^{s+1}(M) = \dots = \tilde{H}^{s+m}(M) = 0, \quad (4)$$

then any form  $\omega$  of bidegree  $(0, s)$ , which is closed in a neighborhood of  $A$ , is the restriction to  $A$  of a form  $\Omega$  that is closed on  $M$ .

◀ Let  $A_1 = \{p \in M : \varphi_1(p) = 0\}$ . By the lemma and condition (4), all the forms belonging to  $\tilde{Z}^j(A_1)$  for  $j = s, \dots, s+m-1$  extend from  $A_1$  to  $M$ , and, moreover,  $\tilde{H}^{s+1}(A_1) = \dots = \tilde{H}^{s+m-1}(A_1) = 0$ . Let  $A_2 = \{p \in A_1 : \varphi_2(p) = 0\} = \{p \in M : \varphi_1(p) = \varphi_2(p) = 0\}$ . By the last conditions we obtain using the same lemma that all the forms belonging to  $\tilde{Z}^j(A_2)$  for  $j = s, \dots, s+m-2$  extend from  $A_2$  to  $A_1$ , and  $\tilde{H}^{s+1}(A_2) = \dots = \tilde{H}^{s+m-2}(A_2) = 0$ . Continuing this argument, we finally obtain that all the forms belonging to  $\tilde{Z}^s(A)$  extend from the set  $A_m = A$  to  $A_{m-1} = \{p \in M : \varphi_1(p) = \dots = \varphi_{m-1}(p) = 0\}$ . Since at the preceding stage we obtained the condition  $\tilde{H}^{s+1}(A_{m-1}) = 0$ , the extended forms again extend to  $A_{m-2}$ , etc.

Returning back along the chain thus constructed, we find that these forms extend to closed forms on the whole manifold  $M$ . ►

**COROLLARY.** *If for some complex manifold  $M$  we have*

$$\tilde{H}^s(M) = 0 \quad \text{for } s = 1, \dots, m, \quad (5)$$

*then any function  $f$  that is holomorphic in a neighborhood of the analytic set  $A = \{p \in M : \varphi_1(p) = \dots = \varphi_m(p)\}$ , where all the  $\varphi_j \in \mathcal{O}(M)$ , extends to a function that is holomorphic in  $M$ .*

We can now pass to the solution of the Levi problem, which we discussed in §13 and which consists in proving that any domain  $D \subset \mathbb{C}^n$  that cannot be extended holomorphically to any of its boundary points is a domain of holomorphy (subsection 37). In subsection 39 we saw that in order to solve this problem it is sufficient to show that any pseudoconvex domain in  $\mathbb{C}^n$  is a domain of holomorphy (the implication  $V \Rightarrow I$  in the scheme at the end of subsection 39).

**THEOREM 2.** *A domain  $D \subset \mathbb{C}^n$  is a domain of holomorphy if and only if*

$$\tilde{H}^s(D) = 0 \quad \text{for } s = 1, \dots, n - 1. \quad (6)$$

◀ *Necessity.* As shown in subsection 39, any domain of holomorphy is pseudoconvex. But by Hörmander's theorem on the solvability of the  $\bar{\partial}$ -problem, condition (6) holds for any pseudoconvex domain.

*Sufficiency.* By Theorem 2 of subsection 33 a domain  $D \subset \mathbb{C}^n$  is a domain of holomorphy if there exists a barrier on an everywhere dense set of points  $\zeta \in \partial D$ , i.e., a holomorphic function in  $D$  that grows unboundedly as  $z \rightarrow \zeta$ . Suppose the point  $\zeta \in \partial D$  is such that at  $\zeta$   $\partial D$  can be tangent to it by a ball  $B \subset D$  (then  $\zeta \in \partial B \cap \partial D$ ). The set of such points is dense on  $\partial D$ , since for any  $\zeta^0 \in \partial D$  and any  $\varepsilon > 0$  one can take a point  $z^0 \in D$  for which  $|z^0 - \zeta^0| < \varepsilon$ ; then the closest point  $\zeta \in \partial D$  to  $z^0$  will possess the desired property and  $|\zeta - \zeta^0| < 2\varepsilon$ .

We denote by  $l$  the complex line passing through  $\zeta$  and the center of the ball  $B$ . This line is an analytic set and intersects  $D$  in an open (on  $l$ ) set  $A$  of real dimension 2. The point  $\zeta \in \partial A$ , and we can construct a holomorphic function in  $A$  with a pole at  $\zeta$  (such a function exists for any open set of the plane). By the conditions (6) and the Corollary to Theorem 1 this function extends to a function  $F \in \mathcal{O}(D)$  that grows unboundedly as  $z \rightarrow \zeta$ , i.e., there is a barrier at the point  $\zeta$ . ►

\* Prove that a domain  $D \subset \mathbb{C}^n$  is a domain of holomorphy if and only if  $H^s(D, \mathcal{O}) = 0$  for  $s = 1, \dots, n - 1$ . \*

**52. Other applications.** The solvability of the  $\bar{\partial}$ -problem, which we have used more than once above, is also applied in a number of other problems of complex analysis. Here we give two examples of such applications.

As the first example we consider the solution of the problem of the local extension of CR-functions, a global variant of which was considered in subsection 31. While the problem is always solvable in the global variant (under certain natural restrictions), in the local variant it is necessary to impose additional conditions on the hypersurface from which the function is to be extended. For example, any function of class  $C^1$  that depends only on  $x_n$  satisfies the tangential Cauchy-Riemann conditions on the real hyperplane  $\{y_n = 0\}$ , but it is clear that not all such functions extend holomorphically from the hyperplane.

We give a result, which for  $n = 2$  was obtained in 1956 by H. LEWY; the proof that we present is due to L. HÖRMANDER.

**THEOREM 1.** *Suppose that a real hypersurface  $S$  is given by the equation  $\varphi(z) = 0$  in a neighborhood  $U$  of a point  $a \in S$ , where  $\varphi \in C^\infty(U)$  and  $\nabla\varphi \neq 0$ . If the restriction of the Levi form  $H_a(\varphi, \omega)$  to the complex tangent plane  $T_a^c(S)$  has at least one positive eigenvalue, then any function  $f \in C^1(S)$ , satisfying the tangential Cauchy-Riemann conditions on  $S$ , extends holomorphically into the part of some neighborhood of the point  $a$  in which  $\varphi < 0$ .<sup>(12)</sup>*

◀ Without loss of generality we may assume that  $a = 0$ , the plane  $T_a(S)$  coincides with  $\{x_1 = 0\}$ ,  $T_a^c(S)$  with  $\{z_1 = 0\}$ , and that the Taylor expansion of  $\varphi$  at 0 has the form

$$\varphi(z) = x_1 + H_0(\varphi, z) + o(|z|^2) \tag{1}$$

(see subsection 37). After an additional nondegenerate  $\mathbb{C}$ -linear transformation of the variables  $(z_2, \dots, z_n)$  we may also assume that the eigenvector corresponding to the positive eigenvalue of  $H_0$  is directed along the  $z_n$ -axis, and then the expansion (1) takes the form

$$\varphi(z) = x_1 + |z_n|^2 + P('z, 'z) + o(|z|^2), \tag{2}$$

where  $P$  is a homogeneous polynomial of degree two relative to the variables  $'z = (z_1, \dots, z_{n-1})$  and  $'z$ .

Then  $\varphi('0, z_n) = |z_n|^2 + o(|z_n|^2)$ , and hence, we may choose a sufficiently small  $\delta > 0$  and then choose an  $\eta > 0$  such that we will have

$$\frac{\partial^2 \varphi}{\partial z_n \partial \bar{z}_n} > 0$$

in the polydisc

$$V = 'V \times \{|z_n| < \delta\}, \quad 'V = \{\|z'\| < \eta\},$$

and the function  $\varphi(z) > 0$  close to its face  $\{|z_n| = \delta\}$ . For such a choice for any fixed  $'z \in 'V$  the set  $\{z_n : |z_n| < \delta, \varphi('z, z_n) > 0\}$  contains a neighborhood of the circle  $\{|z_n| = \delta\}$  and is connected, since  $\varphi$  as a subharmonic function of  $z_n$  does not have local maxima in the disc  $\{|z_n| < \delta\}$ .

<sup>(12)</sup>See subsection 37 for the terms and notations.

The function  $f$  can be extended smoothly into  $V$ , and since it satisfies the tangential Cauchy-Riemann conditions on  $S$ , then

$$\bar{\partial}f = h_0\bar{\partial}\varphi + \varphi\omega_1 \tag{3}$$

in  $V$ , where  $h_0$  is a smooth function and  $\omega_1$  is a form of bidegree  $(0, 1)$  (see the exercise at the beginning of subsection 37). In  $V$  we construct a smooth function  $g_0$  such that

$$g_0|_S = f \quad \text{and} \quad \bar{\partial}g_0 = O(\varphi^2) \tag{4}$$

in a neighborhood of  $S$ . This can be done in the following way. First we note that by (3) we have  $\bar{\partial}(f - h_0\varphi) = \varphi(\omega_1 - \bar{\partial}h_0) \stackrel{\text{def}}{=} \varphi\omega_2$ , from which we find  $0 = \bar{\partial}(\varphi\omega_2) = \bar{\partial}\varphi \wedge \omega_2 + \varphi\bar{\partial}\omega_2$ . Therefore  $\bar{\partial}\varphi \wedge \omega_2|_S = 0$ , and hence,  $\omega_2 = h_1\bar{\partial}\varphi + \varphi\omega_3$ , where  $h_1$  is some function and  $\omega_3$  is a form. It remains to set  $g_0 = f - h_0\varphi - h_1\varphi^2/2$ ; then

$$\bar{\partial}g_0 = \varphi\omega_2 - h_1\varphi\bar{\partial}\varphi - (\varphi^2/2)\bar{\partial}h_1 = \varphi^2(\omega_3 - (1/2)\bar{\partial}h_1)$$

and this function satisfies the conditions (4).

We let  $D = \{z \in V : \varphi(z) < 0\}$  and

$$\Omega = \begin{cases} \bar{\partial}g_0 & \text{in } D, \\ 0 & \text{in } V \setminus D; \end{cases} \tag{5}$$

by (4) this form belongs to the class  $C^1(V)$ , since on  $\partial D \cap V$  we have  $\varphi = 0$ , and it is  $\bar{\partial}$ -closed. For any  $'z \in 'V$  the form  $\Omega$  is compactly supported with respect to  $z_n$  (since  $\varphi > 0$  in a neighborhood of  $\{|z_n| = \delta\}$ , and hence,  $\Omega = 0$ ), and we consider the function

$$\begin{aligned} \hat{f}(z) &= \frac{1}{2\pi i} \int_{\mathbb{C}} \frac{a_n('z, \zeta_n)}{\zeta_n - z_n} d\zeta_n \wedge d\bar{\zeta}_n \\ &= \frac{1}{2\pi i} \int_{\mathbb{C}} \frac{a_n('z, z_n + \zeta_n)}{\zeta_n} d\zeta_n \wedge d\bar{\zeta}_n, \end{aligned} \tag{6}$$

where  $a_n$  is the coefficient for  $d\bar{z}_n$  in the expression for  $\Omega$ .

Since  $\Omega$  is  $\bar{\partial}$ -closed we have

$$\bar{\partial}\hat{f} = \Omega \tag{7}$$

(see subsection 45), and since  $\Omega = 0$  outside of  $\bar{D}$ ,  $\hat{f}$  is a holomorphic function there. But, as we see from (2), there is a point  $'z^0 \in 'V$  with positive  $x_1^0$ , close to which there are no points of  $D$ , so that  $a_n('z, z_n) = 0$  there for all  $z_n$ , and according to (6) the function  $\hat{f}(z) = 0$ . The set of such points is open, and since by what was proved above for any fixed  $'z \in 'V$  the set  $\{z_n : \varphi('z, z_n) < 0\}$  is connected and contains  $\{|z_n| = \delta\}$ , then  $\hat{f}(z) \equiv 0$  outside  $D$ .

We now consider the function  $F = g_0 - \hat{f} \in C^2(V)$ . In  $V \setminus D$  it coincides with  $g_0$  and by (4) it is equal to  $f$  on  $\partial D \cap V$ , and in the domain  $D$  we

have  $\bar{\partial}F = \bar{\partial}g_0 - \Omega = 0$  by (5) and (7). Thus,  $F$  extends the function  $f$  holomorphically from  $S = \partial D$  to the part of  $D$  of the neighborhood of  $z = 0$  where  $\varphi(z) < 0$ . ►

As a second example we consider a modification of the integral representation of the solutions of Maxwell's equations obtained in subsection 16. The formulas that we shall indicate here are significantly more convenient for applications. In subsection 16 we proved that the Penrose transformation  $\mathcal{P}$  associates to each  $\bar{\partial}$ -closed  $(0, 1)$ -form  $\omega$  in the domain  $D_+$  of the twistor space  $\mathbb{P}^3$  with coefficients of homogeneity  $-4$  with respect to the variables  $w_j$  a self-dual solution of Maxwell's equations

$$F^+(Z) = f_1\Phi_I + f_2\Phi_{II} + f_3\Phi_{III},$$

where  $\Phi_I$ ,  $\Phi_{II}$ , and  $\Phi_{III}$  are special forms of bidegree  $(2, 0)$ , and the coefficients are expressed in the form of an integral over the projective line  $l = p(Z)$  and are holomorphic in the domain  $M_+^c$ :<sup>(13)</sup>

$$f_k(Z) = \int_{p(Z)} w_0^{3-k} w_1^{k-1} \omega|_l (w_0 dw_1 - w_1 dw_0), \quad k = 1, 2, 3. \quad (8)$$

Likewise we noted there (see the Remark following Theorem 1 of subsection 16) that  $\bar{\partial}$ -exact forms correspond to null solutions, so that the transformation  $\mathcal{P}$  is in fact not defined by the form  $\omega$ , but by its cohomology class. By Dolbeault's theorem the quotient group of  $\bar{\partial}$ -closed forms of bidegree  $(0, 1)$  in  $D_+$  with coefficients of homogeneity  $-4$  modulo  $\bar{\partial}$ -exact forms of the same type is isomorphic to the first cohomology group  $H^1(D_+, \mathcal{O}(-4))$  of the domain  $D_+$  with holomorphic coefficients of homogeneity  $-4$ .

The domain  $D_+$  is not a domain of holomorphy (it contains many projective lines, and at each point  $N$  of its boundary the restriction of the Levi form to  $T^c(N)$  has eigenvalues with different signs) and does not even admit a finite covering by domains of holomorphy. Therefore the above-mentioned quotient group cannot be realized as a cohomology group for a finite covering of  $D_+$  (see subsection 48). Nevertheless this domain can be covered by only two domains, such that such a realization would be possible for the restrictions to the projective lines in  $D_+$ . In fact, since  $\text{Im}(w_0\bar{w}_2 + w_1\bar{w}_3) \neq 0$  in  $D_+$  (see subsection 13), there are no points in  $D_+$  for which we simultaneously have  $w_0 = w_1 = 0$ , and hence, this domain is covered by two domains  $U^\alpha = \{w \in D_+ : w_\alpha \neq 0\}$ ,  $\alpha = 0, 1$ . For points  $Z \in M^c$  the equations of the corresponding projective line  $l = p(Z)$  have the form

$$w_2 = z_{00}w_0 + z_{01}w_1, \quad w_3 = z_{10}w_0 + z_{11}w_1, \quad (9)$$

where for  $Z \in M_+^c$  the line lies entirely inside  $D_+$  (subsection 13). Since on each such line  $l$  there are also no points with  $w_0 = w_1 = 0$ , then it is also

<sup>(13)</sup>Here we consider  $D_+$  and  $M_+^c$  for definiteness; we can replace them by  $D_-$  and  $M_-^c$ .



covered by the two domains  $u^\alpha = U^\alpha \cap l$ , each of which is obtained from  $l$  by deleting a single point.

We shall show that on any fixed line  $l \subset D_+$  the first cohomology group with holomorphic coefficients of homogeneity  $-4$  for this covering is isomorphic to the quotient group of the corresponding differential forms. The proof will consist of the construction of a correspondence between forms and holomorphic functions. In this connection we will also obtain new expressions for the coefficients  $f_k$  of the form  $F^+$ , which are more suitable for applications.

For the covering being considered there exists only one intersection  $U^{01} = U^0 \cap U^1$ , and any holomorphic function  $f$  of homogeneity  $-4$  in  $U^{01}$ , i.e., a function of the homogeneous coordinates  $w_0, \dots, w_3$  such that  $w_0^4 f$  and  $w_1^4 f$  in  $U^{01}$  are expressed holomorphically using local coordinates, will be a cocycle. The cocycle  $f|_l$  is a coboundary if there are functions  $f_l^\alpha$  such that  $w_\alpha^4 f_l^\alpha \in \mathcal{O}(u^\alpha)$ ,  $\alpha = 0, 1$ , and

$$f|_l = f_l^1 - f_l^0 \quad \text{in } u^{01} = u^0 \cap u^1. \tag{10}$$

**THEOREM 2.** *The decomposition (10) is possible if and only if, for any closed contour  $\gamma_l \subset l$  we have*

$$\int_{\gamma_l} w_0^{3-k} w_1^{k-1} f(w)(w_0 dw_1 - w_1 dw_0) = 0 \quad \text{for } k = 1, 2, 3. \tag{11}$$

◀ If  $\zeta = w_1/w_0$  is a local parameter on  $u^0$ , then in  $u^{01} = \{0 < |\zeta| < \infty\}$  the function  $w_0^4 f|_l$  is represented by the Laurent series

$$w_0^4 f|_l = \sum_{n=-\infty}^{\infty} c_n \zeta^n.$$

The integrand in (11) can be written in the form  $\zeta^{k-1} w_0^4 f d\zeta$ , and, choosing  $\gamma_l = \{|\zeta| = \rho\}$ , we obtain from (11) that  $c_{-1} = c_{-2} = c_{-3} = 0$ . Therefore it follows from (11) that

$$f|_l = \frac{1}{w_0^4} \sum_{n=0}^{\infty} c_n \zeta^n + \frac{1}{w_1^4} \sum_{n=0}^{\infty} c_{-n-4} \left(\frac{1}{\zeta}\right)^n;$$

the first sum here is holomorphic in  $u^0$ , and the second is holomorphic in the domain  $u^1$ , where the parameter is  $1/\zeta$ , so that  $f|_l = f_l^1 - f_l^0$ , and the cocycle  $f|_l$  is a coboundary.

Conversely, if  $f|_l$  is a coboundary, then (10) holds and then the function  $w_0^4 f_l^0$  is holomorphic inside of  $\gamma_l$ , and the expansion of  $w_0^4 f_l^1 = w_1^4 \zeta^{-4} f_l^1$  in powers of  $1/\zeta$  begins with  $1/\zeta^4$ , so that the integrals in (11) are equal to 0. ▶

It turns out that the integrals of (11), which are obstructions to the cocycle  $f|_l$  being a coboundary, can simultaneously be used as the coefficients of the forms that satisfy Maxwell's equations.

**THEOREM 3.** *For any function  $f$  of homogeneity  $-4$ , holomorphic in  $U^{01}$ , the form  $F^+$  with the coefficients*

$$f_k(Z) = \frac{1}{2\pi i} \int_{\gamma_l} w_0^{3-k} w_1^{k-1} f(w)(w_0 dw_1 - w_1 dw_0), \quad k = 1, 2, 3, \quad (12)$$

where  $\gamma_l$  is a closed contour on the projective line  $l = p(Z)$ , is a solution of Maxwell's equations in the domain  $M_+^c$ , and any self-dual solution of these equations in  $M_+^c$  is represented in this way.

◀ We shall carry out the proof by establishing a correspondence between holomorphic functions and  $\bar{\partial}$ -closed forms, under which the formulas for the coefficients (12) and (8) turn out to be identical; then everything reduces to what was proved in subsection 16.

Suppose we are given a function  $f$ , satisfying the hypotheses of the theorem, a line  $l = p(Z)$ , and a contour  $\gamma_l$  on it, going around the point  $\zeta = 0$ , where  $\zeta = w_1/w_0$  is a parameter on  $U^0 \cap l$ . We denote by  $\chi$  a smooth function, equal to 1 on  $\gamma_l$  and outside this contour, and equal to 0 in a neighborhood of the point  $\zeta = 0$ . The differential form

$$\omega_l = f|_l \frac{\partial \chi}{\partial \bar{\zeta}} d\bar{\zeta} = f|_l \bar{\partial} \chi$$

of bidegree  $(0, 1)$  and homogeneity  $-4$  extends as a  $\bar{\partial}$ -closed form to  $l$ . The coefficients

$$\begin{aligned} f_k(Z) &= \int_{\mathbb{C}} \zeta^{k-1} w_0^4 \omega_l \wedge d\zeta \\ &= \int_{\mathbb{C}} \zeta^{k-1} w_0^4 f|_l \bar{\partial} \chi \wedge d\zeta = \int_{\mathbb{C}} d(\zeta^{k-1} \chi w_0^4 f|_l d\zeta) \end{aligned}$$

are constructed from it and from formula (8) (we have used the fact that  $w_0^4 f|_l$  is holomorphic as a function of  $\zeta$ ). By Stokes's theorem and taking into account that  $\chi$  is equal to 1 on  $\gamma_l$  and to 0 in a neighborhood of  $\zeta = 0$ , we will obtain

$$f_k(Z) = \int_{\gamma_l} \zeta^{k-1} w_0^4 f|_l d\zeta,$$

and this (up to a factor that is inessential since Maxwell's equations are linear) coincides with (12). It remains to choose for all  $l \subset D$  a family of contours  $\gamma_l$ , smoothly depending on  $l$ , and to construct a single form  $\omega$  in  $D_+$  from the forms  $\omega_l$ , constructed as above (we omit the details of this construction).

Conversely, if in  $D_+$  we are given a  $\bar{\partial}$ -closed  $(0, 1)$ -form  $\omega$  of homogeneity  $-4$ , then for a fixed line  $l \subset D_+$  its restriction  $\omega|_l = b_0 d\bar{w}_0 + b_1 d\bar{w}_1$ , and  $b_0 \bar{w}_0 + b_1 \bar{w}_1 \equiv 0$  since it is well defined (see subsection 16). In the domains  $u^0 = U^0 \cap l$  and  $u^1 = U^1 \cap l$  with local coordinates  $\zeta = w_1/w_0$  and  $\eta = w_0/w_1$  we have respectively

$$w_0^4 \omega|_l = w_0^4 \bar{w}_0 b_1 d\bar{\zeta}, \quad w_1^4 \omega|_l = w_1^4 \bar{w}_1 b_0 d\bar{\eta},$$

and since the  $\bar{\partial}$ -problem is solvable in these domains there are smooth functions  $\varphi_0$  and  $\varphi_1$  in them such that

$$w_0^4 \bar{w}_0 b_1 = \partial \varphi_0(\zeta) / \partial \bar{\zeta}, \quad w_1^4 \bar{w}_1 b_0 = \partial \varphi_1(\eta) / \partial \bar{\eta}.$$

From the relation  $b_0 \bar{w}_0 + b_1 \bar{w}_1 = 0$  we then obtain that in the intersection  $u^{01} = u^0 \cap u^1$

$$\frac{\partial \varphi_0}{\partial \bar{\zeta}} = \zeta^{-4} \frac{\partial \varphi_1(1/\zeta)}{\partial \bar{\zeta}},$$

and, hence, the function

$$g(\zeta) = \varphi_0(\zeta) - \frac{1}{\zeta^4} \varphi_1\left(\frac{1}{\zeta}\right) \quad (13)$$

is holomorphic there.

The coefficients of formula (8) in correspondence with this are transformed in two ways:

$$\begin{aligned} f_k(Z) &= \int_{\mathbb{C}} \zeta^{k-1} w_0^4 \omega|_l \wedge d\zeta \\ &= \int_{\mathbb{C}} \zeta^{k-1} \frac{\partial \varphi_0(\zeta)}{\partial \bar{\zeta}} d\bar{\zeta} \wedge d\zeta = \int_{\mathbb{C}} d(\zeta^{k-1} \varphi_0(\zeta) d\zeta), \\ f_k(Z) &= - \int_{\mathbb{C}} \eta^{3-k} w_1^4 \omega|_l \wedge d\eta \\ &= - \int_{\mathbb{C}} \eta^{3-k} \frac{\partial \varphi_1(\eta)}{\partial \bar{\eta}} d\bar{\eta} \wedge d\eta = - \int_{\mathbb{C}} d(\eta^{3-k} \varphi_1(\eta) d\eta), \end{aligned}$$

or, applying Stokes's theorem,

$$f_k(Z) = \int_{\gamma_R} \zeta^{k-1} \varphi_0(\zeta) d\zeta + \alpha = - \int_{\gamma_R} \eta^{3-k} \varphi_1(\eta) d\eta + \beta,$$

where  $\gamma_R$  is a circle of radius  $R$  with center at the origin, and  $\alpha \rightarrow 0$  and  $\beta \rightarrow 0$  as  $R \rightarrow \infty$ . Making the change of variables  $\eta = 1/\zeta$  in the second expression and combining this expression with the first, we obtain

$$2f_k(Z) = \int_{\gamma_R} \zeta^{k-1} \varphi_0(\zeta) d\zeta - \int_{\gamma_{1/R}} \zeta^{k-5} \varphi_1\left(\frac{1}{\zeta}\right) d\zeta + \alpha + \beta.$$

Finally, substituting  $\frac{1}{\zeta^4} \varphi_1\left(\frac{1}{\zeta}\right) = \varphi_0(\zeta) - g(\zeta)$  from (13) in the second integral, we will have

$$\begin{aligned} 2f_k(Z) &= \int_{\gamma_R} \zeta^{k-1} \varphi_0(\zeta) d\zeta \\ &\quad - \int_{\gamma_{1/R}} \zeta^{k-1} \varphi_0(\zeta) d\zeta + \int_{\gamma_{1/R}} \zeta^{k-1} g(\zeta) d\zeta + \alpha + \beta. \end{aligned}$$

Here the third integral can be replaced by an integral over any closed contour  $\gamma_l \subset l$  that goes around the point  $\zeta = 0$ ; for  $R \rightarrow \infty$  the first integral tends

to  $f_k(Z)$ , and the second tends to zero, and in the limit we obtain

$$f_k(Z) = \int_{\gamma_l} \zeta^{k-1} g(\zeta) d\zeta = \int_{\gamma_l} \zeta^{k-1} w_0^4 f_l(w) d\zeta, \quad k = 1, 2, 3, \quad (14)$$

where  $f_l(w) = g(\zeta)/w_0^4$  is a function of homogeneity  $-4$ . This formula (up to an inessential factor) coincides with (12). It remains to construct a single function  $f \in \mathcal{O}(D_+, O(-4))$  from these  $f_l$ , but we will not discuss this. ►

**REMARK.** Instead of  $\{w_0 = 0\}$  and  $\{w_1 = 0\}$  we can take two arbitrary complex hyperplanes  $\Pi_1, \Pi_2 \subset \mathbb{P}^3$ , whose line of intersection lies outside of  $D_+$ . Then any line  $l \subset D_+$  will intersect them in two points. As  $u^0$  and  $u^1$  we can take  $l$  with punctures at these points, and as  $f$  we can take a function of homogeneity  $-4$ , holomorphic in  $D_+$  without  $\Pi_1$  and  $\Pi_2$ ; then the proof of Theorem 3 is essentially unchanged.

**EXAMPLES.**

1. Let  $f(w) = 1/(w_0^3 w_3)$ ; since according to (9)  $w_3 = z_{10} w_0 + z_{11} w_1$  on the line  $l = p(Z)$ , then in (14) the function  $g(\zeta) = w_0^4 f|_l = (z_{10} + z_{11} \zeta)^{-1}$ . Therefore the coefficients

$$f_k(Z) = \frac{1}{2\pi i} \int_{\gamma_l} \frac{\zeta^{k-1} d\zeta}{z_{10} + z_{11} \zeta}, \quad k = 1, 2, 3.$$

The integrands here have a simple pole at the point  $\zeta = -z_{10} z_{11}^{-1}$ , and using the standard method of residues we find

$$f_1 = 1/z_{11}, \quad f_2 = -z_{00}/z_{11}^2, \quad f_3 = z_{00}^2/z_{11}^3. \quad (15)$$

We recall now that the quantities  $F_k = E_k + iH_k$  are expressed using the  $f_j$  by the formulas

$$F_1 = 2f_2, \quad F_2 = f_3 - f_1, \quad F_3 = i(f_3 + f_1) \quad (16)$$

(see subsection 16). For the solution of (15) we have  $f_1 f_3 = f_2^2$ , from which  $F_1^2 + F_2^2 + F_3^2 = 0$ . The last equality means that the moduli of the vectors of the intensity of the electrical and magnetic fields are equal, and these vectors are orthogonal:  $|E| = |H|$ ,  $(E, H) = 0$ . Such solutions of Maxwell's equations are termed *isotropic*.

2. Let  $f(w) = w_2/(w_0^3 w_3^2)$ ; then on the line  $l$  we have  $g(\zeta) = (z_{00} + z_{01} \zeta)/(z_{10} + z_{11} \zeta)^2$  and the integrands in (14) have a second-order pole. Calculating the residue by standard formulas, we find

$$f_1 = \frac{z_{01}}{z_{11}^2}, \quad f_2 = \frac{z_{00}}{z_{11}^2} - 2 \frac{z_{01} z_{10}}{z_{11}^3}, \quad f_3 = \frac{z_{10}}{z_{11}^3} \left( 3 \frac{z_{01} z_{10}}{z_{11}} - 2z_{00} \right).$$

3. In the previous examples the solutions, holomorphic in  $M_+^c$ , had a singularity on real Minkowski space. In order to obtain a solution without singularities on  $M$ , we must choose a function  $f$  such that the hyperplanes of its singularities do not intersect on the boundary of  $D_+$  (like  $\{w_0 = 0\}$  and  $\{w_3 = 0\}$  in the previous examples), but in the domain  $D_-$ . For example, we can set  $f(w) = (w_3 + iw_1)^{-3} (w_2 + iw_0)^{-1}$ ; then

$$f_1 = z_{01}^2/\Delta^3, \quad f_2 = -(z_{00} + i)z_{01}/\Delta^3, \quad f_3 = (z_{00} + i)^2/\Delta^3,$$

where  $\Delta = z_{01} z_{10} - (z_{00} + i)(z_{11} + i) = 1 - \|x\|^2 - 2ix_0 \neq 0$  on  $M$  (here  $\|x\|^2 = x_0^2 - x_1^2 - x_2^2 - x_3^2$ ).

In conclusion we note that Penrose's method of twistors, which we discussed in subsections 13 and 16 and here, has turned out to be fruitful not only in the solution of Maxwell's equations, but also in a number of other important problems of mathematical physics.<sup>(14)</sup>

### §18. Higher-dimensional residues

Recall that the residue of a function of one complex variable  $f$  at an isolated singular point  $a$  of a single-valued nature is the integral of  $f$  over any circle  $\gamma$  of sufficiently small radius with center at the point  $a$ , divided by  $2\pi i$ :

$$R_a = \frac{1}{2\pi i} \int_{\gamma} f dz.$$

If the function  $f$  is holomorphic in  $D$  everywhere except for a finite number of singular points  $a_\nu$ , then sufficiently small circles  $\gamma_\nu$  with centers  $a_\nu$  form a basis of the one-dimensional homology of the domain  $D' = D \setminus \bigcup \{a_\nu\}$ . If for some one-dimensional cycle (closed path)  $\gamma \subset D'$  the decomposition with respect to this basis is known,  $\gamma \sim \sum_{\nu=1}^N k_\nu \gamma_\nu$  (where  $\sim$  denotes "homologous to"), and the residues  $R_\nu$  of the function  $f$  at the point  $a_\nu$  are known, then  $\int_{\gamma} f dz = 2\pi i \sum_{\nu=1}^N k_\nu R_\nu$  (residue theorem).

An analogous situation also occurs in higher dimensions. However, in passing to the higher-dimensional case the practical calculation of the integrals encounters a number of difficulties, mostly of a topological nature.

**53. The theory of Martinelli.** In order to present this theory we need some topological concepts.

Let  $M$  be a smooth orientable manifold of dimension  $m$  and let  $\alpha: Q^r \rightarrow M$  and  $\beta: Q^s \rightarrow M$  be cells of COMPLEMENTARY DIMENSION (i.e.,  $r+s=m$ ), intersecting TRANSVERSALLY at a point  $p \in \alpha \cap \beta$ . The last condition means that a basis of the tangent vectors  $v_1, \dots, v_r \in T_p(\alpha)$  together with a basis  $v_{r+1}, \dots, v_m \in T_p(\beta)$  forms a basis of  $T_p(M)$ , and, in particular, it follows from this that in a neighborhood of  $p$   $\alpha$  and  $\beta$  are submanifolds of  $M$ . Suppose that  $\alpha$  and  $\beta$  are oriented and that the forms  $\omega'$  and  $\omega''$  ( $\deg \omega' = r$ ,  $\deg \omega'' = s$ ) are positive on them in a neighborhood of  $p$ . We shall say that the *intersection index* of  $\alpha$  and  $\beta$  at  $p$  is  $+1$  if the  $m$ -form  $\omega = \omega' \wedge \omega''$  is positive on  $M$  in a neighborhood of  $p$ , and  $-1$  if it is negative (Figure 47).

If  $\sigma^r = \sum k_\nu \alpha_\nu$  and  $\tau^s = \sum l_\nu \beta_\nu$  are chains on  $M$  of complementary dimension ( $\dim \sigma^r = r$ ,  $\dim \tau^s = s$ ,  $r+s=m$ ) and intersect transversally in a finite number of points  $p_j$ , then we define their *intersection index*  $i(\sigma^r, \tau^s)$  to be the sum of the intersection indices of the corresponding cells at all the points  $p_j$ , multiplied by the product of the coefficients with which these cells

<sup>(14)</sup>See, for example, the collection of articles translated from the English, *Twistors and gauge fields*, "Mir", Moscow, 1983. (For a list of the articles see MR 84m:32044.)

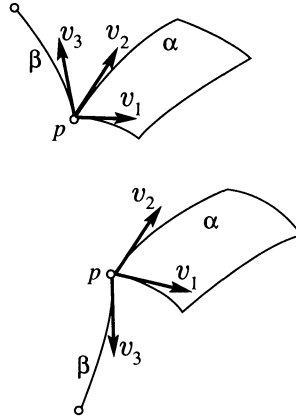

FIGURE 47

are included in the chain. (For example, if the cells  $\alpha_\mu$  and  $\beta_\nu$  intersect at a point  $p_j$  with index  $-1$ , then the contribution of the term corresponding to this point to the sum defining the intersection index of the chains is equal to  $-k_\mu l_\nu$ .)

Notice the following simple properties of the intersection index:

- 1)  $i(\sigma^r, \tau^s) = -i(-\sigma^r, \tau^s) = -i(\sigma^r, -\tau^s)$ ;
- 2)  $i(\sigma^r, \tau^s) = (-1)^{rs} i(\tau^s, \sigma^r)$ ;
- 3)  $i(\sigma^r, \tau_1^s + \tau_2^s) = i(\sigma^r, \tau_1^s) + i(\sigma^r, \tau_2^s)$ .

We also note a geometrically obvious property: if both chains  $\sigma^r$  and  $\tau^s$  are cycles (i.e., the boundaries  $\partial\sigma^r$  and  $\partial\tau^s$  are equal to zero), and at least one of them is a cycle that is homologous to zero on  $M$  (i.e., is the boundary of some chain that belongs to  $M$ ), then  $i(\sigma^r, \tau^s) = 0$ .

Further, on an orientable manifold  $M$  we consider two cycles  $\sigma^r$  and  $\tau^{s-1}$  that are homologous to zero (as before, we assume that  $r + s = m$ ); assume that they do not intersect. There exists a chain  $T^s \subset M$  such that  $\tau^{s-1} = \partial T^s$ , and if  $T_1^s \subset M$  is another chain with boundary  $\tau^{s-1}$ , then by the above-mentioned properties of the intersection index we have

$$i(\sigma^r, T^s) - i(\sigma^r, T_1^s) = i(\sigma^r, T^s - T_1^s) = 0,$$

since  $T^s - T_1^s$  is a cycle<sup>(15)</sup> on  $M$ , and  $\sigma^r$  is homologous to zero. Thus, under these assumptions the intersection index of a cycle  $\sigma^r$  with any chain  $T^s \subset M$  whose boundary  $\partial T^s = \tau^{s-1}$ , does not depend on the choice of this chain and is determined (for given  $M$  and  $\sigma^r$ ) only by the cycle  $\tau^{s-1}$ . We call this index the *linking coefficient of the cycles*  $\sigma^r$  and  $\tau^{s-1}$  and denote it by the symbol  $c(\sigma^r, \tau^{s-1})$ ; thus, by definition,

$$c(\sigma^r, \tau^{s-1}) = i(\sigma^r, T^s). \tag{1}$$

<sup>(15)</sup>The boundary  $\partial(T^s - T_1^s) = \tau^{s-1} - \tau^{s-1} = 0$ .

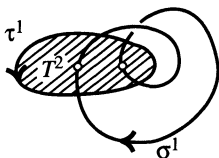

FIGURE 48

(In Figure 48 the linking coefficient of two one-dimensional cycles  $\tau^1$  and  $\sigma^1$ , homologous to zero in  $\mathbb{R}^3$ , is equal to 2.)

We note the following simple properties of the linking coefficient:

- 1)  $c(\sigma^r, \tau^{s-1}) = -c(-\sigma^r, \tau^{s-1}) = -c(\sigma^r, -\tau^{s-1})$ ;
- 2)  $c(\sigma^r, \tau^{s-1}) = (-1)^{r(s-1)} c(\tau^{r-1}, \sigma^s)$ ;
- 3)  $c(\sigma^r, \tau_1^{s-1} + \tau_2^{s-1}) = c(\sigma^r, \tau_1^{s-1}) + c(\sigma^r, \tau_2^{s-1})$ .

We also note another property: if two cycles  $\sigma_1^r$  and  $\sigma_2^r$ , homologous to zero on  $M$ , are homologous to each other on  $M \setminus \tau^{s-1}$  (where  $\tau^{s-1}$  is a cycle that is homologous to zero on  $M$ ), then

$$c(\sigma_1^r, \tau^{s-1}) = c(\sigma_2^r, \tau^{s-1}). \tag{2}$$

In conclusion we state without proof the following

**DUALITY PRINCIPLE** (J. Alexander and L. S. Pontryagin).<sup>(16)</sup> *Let  $S$  be a sphere of real dimension  $m$  and let  $K \subset S$  be some polyhedron. Then for a basis  $\{\sigma_\mu^r\}$  of the  $r$ -dimensional homology of the complex  $S \setminus K$  there exists a dual basis  $\{\tau_\nu^{s-1}\}$  of the  $(s - 1)$ -dimensional homology of the polyhedron  $K$  (where  $r + s = m$ ) such that, for all  $\mu, \nu$ ,*

$$c(\sigma_\mu^r, \tau_\nu^{s-1}) = \delta_{\mu\nu}, \tag{3}$$

where  $\delta_{\mu\nu}$  is the Kronecker symbol.

We pass to questions of the computation of integrals. Suppose that in a domain  $D \subset \mathbb{C}^n$  we are given a meromorphic function  $f$  with polar set  $P$  and we must compute the integral of the form  $\omega = f dz = f(z) dz_1 \wedge \dots \wedge dz_n$  over some  $n$ -dimensional cycle  $\sigma \subset D \setminus P$ . If  $\sigma$  is homologous to zero in  $D \setminus P$ , then by the Cauchy-Poincaré theorem

$$\int_\sigma f dz = 0.$$

---

<sup>(16)</sup>For the definition of a polyhedron and the proof of the duality principle see the book by P. S. Aleksandrov, *Combinatorial topology*, OGIZ, Moscow and Leningrad, 1947; English transl., Graylock Press, Albany, NY, 1960. A system of  $r$ -dimensional cycles  $\{\sigma_\mu^r\}$  on a polyhedron  $K$  is called a basis of the  $r$ -dimensional homology of  $K$  if: (1) it is homologically independent, i.e., the fact that some chain  $\sum k_\mu \sigma_\mu^r$  on  $K$  is homologous to zero implies that all the  $k_\mu = 0$ , and (2) any  $r$ -dimensional cycle  $\sigma$  on  $K$  is homologous to some linear combination of the  $\sigma_\mu^r$ .

By the same theorem and by the properties of integrals, if a cycle  $\sigma'$  is homologous to  $\sigma$  in  $D \setminus P$ , then

$$\int_{\sigma'} f dz = \int_{\sigma} f dz.$$

It follows from this that if a basis  $\{\sigma_{\mu}\}$  of the  $n$ -dimensional homology of the set  $D \setminus P$  is known as is the decomposition

$$\sigma \sim \sum_{\mu=1}^{\rho} k_{\mu} \sigma_{\mu} \quad (4)$$

with respect to this basis, then the computation of the integral of  $f$  over  $\sigma$  reduces to the computation of the integrals over the cycles of the basis:

$$\int_{\sigma} f dz = \sum_{\mu=1}^{\rho} k_{\mu} \int_{\sigma_{\mu}} f dz.$$

By analogy with the one-dimensional case we call the quantity

$$R_{\mu} = \frac{1}{(2\pi i)^n} \int_{\sigma_{\mu}} f dz \quad (5)$$

the *residue* of the function  $f$  relative to the basis cycle  $\sigma_{\mu}$ . Then we have the following

**THEOREM 1 (concerning residues).** *If the function  $f$  is meromorphic in a domain  $D \subset \mathbb{C}^n$  and  $P$  is the polar set of  $f$ , then for any  $n$ -dimensional cycle  $\sigma \subset D \setminus P$  we have*

$$\int_{\sigma} f dz = (2\pi i)^n \sum_{\mu=1}^{\rho} k_{\mu} R_{\mu}, \quad (6)$$

where  $k_{\mu}$  are the coefficients in the decomposition of  $\sigma$  with respect to a basis of the  $n$ -dimensional homology of  $D \setminus P$ , and  $R_{\mu}$  are the residues of  $f$  relative to the cycles of this basis.

In the higher-dimensional case, in contrast to the case of the plane, the search for the basis  $\{\sigma_{\mu}\}$  and the decomposition (4) with respect to this basis is far from being a simple problem. In 1953 E. MARTINELLI noted that in a number of cases the problem can be simplified in an essential way if we use the duality principle described above.<sup>(17)</sup> To make the application of this principle possible we assume that the domain  $D$  is homeomorphic to the  $2n$ -dimensional ball. We identify all the points of the boundary of  $D$  to a single point and complete  $D$  by this point; we obtain a  $2n$ -dimensional

<sup>(17)</sup>This method has been developed further in the works of A. P. YUZHAKOV, who, in particular, carried out a study of the residues of certain classes of rational functions; see the book by L. A. AIZENBERG and A. P. YUZHAKOV, *Integral representations and residues in multidimensional complex analysis*, "Nauka", Novosibirsk, 1979; English transl., Transl. Math. Monographs, vol. 58, Amer. Math. Soc., Providence, RI, 1983.



sphere  $\dot{D}$ . In precisely the same way we identify all the points of intersection of the set  $P$  for the function  $f$  with  $\partial D$  to a single point and denote by  $\dot{P}$  the completion of  $P$  by adding this point. This process obviously does not disturb the  $n$ -dimensional homology basis  $\{\sigma_\mu\}$  or the decomposition (4) with respect to this basis. In other words,  $\{\sigma_\mu\}$  remains a basis of the  $n$ -dimensional homology of  $\dot{D}\setminus\dot{P}$  and (4) remains the decomposition of the cycle  $\sigma$  with respect to it.

Instead of the basis  $\{\sigma_\mu\}$  of the  $n$ -dimensional homology of  $\dot{D}\setminus\dot{P}$ , on the basis of the duality principle we can search for a dual basis  $\{\tau_\nu\}$  of the  $(n - 1)$ -homology of the polar set  $P$  itself, connected with the first basis by the relations

$$c(\sigma_\mu, \tau_\nu) = \delta_{\mu\nu}. \tag{7}$$

For brevity the cycles  $\tau_\nu$  will be called *singular cycles*.

We note that the coefficients  $k_\mu$  of the decomposition of the cycle  $\sigma$  with respect to the basis  $\{\sigma_\mu\}$  coincide with the linking coefficients of this cycle with the cycles of the dual basis  $\{\tau_\nu\}$ . Indeed, since  $\sigma$  is homologous to  $\sum_{\mu=1}^\rho k_\mu \sigma_\mu$  in  $\dot{D}\setminus\dot{P}$ , then by the above-mentioned property of the linking coefficients we have

$$c(\sigma, \tau_\nu) = c\left(\sum_{\mu=1}^\rho k_\mu \sigma_\mu, \tau_\nu\right),$$

and from this, using property 3) and the relations (7), we find that

$$c(\sigma, \tau_\nu) = k_\nu. \tag{8}$$

This remark allows us to find the  $k_\mu$  without knowing the basis  $\{\sigma_\mu\}$  itself. The integrals over the basis cycles  $\sigma_\mu$  (the residues of the function  $f$ ) can also be computed without finding these cycles. In fact, suppose that in  $\dot{D}\setminus\dot{P}$  we have found some  $\rho$  homologically independent  $n$ -dimensional cycles  $\gamma_\mu$ , with respect to which we are able to compute the integrals

$$\int_{\gamma_\mu} f dz = I(\gamma_\mu), \quad \mu = 1, \dots, \rho.$$

Suppose that we also know the linking coefficients  $c(\gamma_\mu, \tau_\nu) = a_{\mu\nu}$  of these cycles with the cycles of the dual basis  $\{\tau_\nu\}$ . By the remark made above the  $a_{\mu\nu}$  are the coefficients of the decomposition of  $\gamma_\mu$  in the basis  $\{\sigma_\nu\}$ , and therefore by the residue theorem we have for any  $\mu = 1, \dots, \rho$

$$I(\gamma_\mu) = (2\pi i)^n \sum_{\nu=1}^\rho a_{\mu\nu} R_\nu, \tag{9}$$

where  $R_\nu$  is the residue of  $f$  relative to the cycle  $\sigma_\nu$ .

The system (9) can be considered to be linear relative to the unknown residues  $R_\nu$ , and its determinant is proportional to  $\det(a_{\mu\nu})$ , which is different from zero because the cycles  $\gamma_\mu$  are homologically independent. Therefore the residues are easily found from this system.

Taking the above-mentioned duality into account, we shall call the integral of  $f$  over the  $n$ -dimensional cycle  $\sigma_\nu$ , divided by  $(2\pi i)^n$ , the *residue relative to the singular cycle*  $\tau_\nu$  (dual to  $\sigma_\nu$ ). Note that this definition emphasizes the analogy between the higher-dimensional case and the planar case, where the integral over the one-dimensional cycle  $\gamma_\nu$ , divided by  $2\pi i$ , is called the residue of  $f$  relative to the singular point  $a_\nu$  (a zero-dimensional cycle). The residue theorem can now be formulated as follows:

**THEOREM 2.** *Suppose that  $f$  is a meromorphic function in a domain  $D \subset \mathbb{C}^n$ , homeomorphic to the  $2n$ -dimensional ball, and let  $\dot{P}$  be the polar set of  $f$ , which is obtained by adding to  $P \cap D$  the set  $P \cap \partial D$ , identified to a point. Let  $\tau_\nu, \nu = 1, \dots, \rho$ , be a basis of the  $(n - 1)$ -dimensional homology of the set  $\dot{P}$ , and let  $R_\nu$  be the residue of  $f$  relative to the singular cycle  $\tau_\nu$ . Then, for any  $n$ -dimensional cycle  $\sigma \subset D \setminus P$  we have*

$$\int_\sigma f dz = (2\pi i)^n \sum_{\nu=1}^{\rho} k_\nu R_\nu, \tag{10}$$

where  $k_\nu = c(\sigma, \tau_\nu)$  is the linking coefficient of  $\sigma$  with the singular cycle  $\tau_\nu$ .

**EXAMPLES.**

1. If  $f$  is an entire function of  $n$  complex variables,  $n > 1$ , and  $l(z) = \sum_{\nu=1}^n \alpha_\nu z_\nu + \beta$  is a linear function, then for any  $n$ -dimensional cycle  $\sigma \subset \mathbb{C}^n \setminus \{l(z) = 0\}$  and for any integer  $m$

$$\int_\sigma \frac{f(z) dz}{(\sum_{\nu=1}^n \alpha_\nu z_\nu + \beta)^m} = 0.$$

In fact, the boundary of the domain  $\mathbb{C}^n$  consists of the points at infinity, which must be identified to a single point. The polar set  $P = \{l(z) = 0\}$  becomes the  $(2n - 2)$ -dimensional sphere  $\dot{P}$  after the identified points at infinity have been added on. For  $n > 1$  any  $(n - 1)$ -dimensional cycle on  $\dot{P}$  is homologous to zero ( $\rho = 0$ ), the basis  $\{\tau_\nu\}$  is trivial, and, hence, the integral is equal to zero.

2. Consider the integral

$$I = \int_\sigma \frac{e^{zw} dz \wedge dw}{(z - 2w)(w - 2z)},$$

where  $\sigma$  is an arbitrary two-dimensional cycle in  $\mathbb{C}^2$ , not intersecting the polar set  $P = P_1 \cup P_2$ , where  $P_1 = \{z = 2w\}$  and  $P_2 = \{w = 2z\}$ .

The completed polar set  $\dot{P}$  consists of two two-dimensional spheres  $\dot{P}_1$  and  $\dot{P}_2$ , which intersect at two points:  $\{z = 0, w = 0\}$  and the identified points at infinity. We must find a basis of the one-dimensional homology of  $\dot{P}$ . Every one-dimensional cycle that lies completely on one of the spheres is obviously homologous to zero. Therefore a cycle that is not homologous to zero must go from the point  $(0, 0)$  along one sphere to  $\infty$  and then return over the other sphere to the same point  $(0, 0)$ . All such cycles are homologous to passing over the cycle  $\tau$  several times;  $\tau$  consists of some ray  $l_1 \subset \dot{P}_1$ , going from  $(0, 0)$  to infinity, and some ray  $l_2^- \subset \dot{P}_2$ , going from infinity to  $(0, 0)$ . Suppose, for example, that  $l_1$  passes through the point  $(2, 1)$ , and  $l_2$  passes through the point  $(1, 2)$ ; then the parametric equations of these rays will have the form

$$l_1: \left. \begin{matrix} z = 2t_1 \\ w = t_1 \end{matrix} \right\}, \quad 0 \leq t_1 \leq \infty; \quad l_2: \left. \begin{matrix} z = t_2 \\ w = 2t_2 \end{matrix} \right\}, \quad 0 \leq t_2 \leq \infty.$$

Here  $\rho = 1$  and hence it suffices to compute the integral of  $f$  over any two-dimensional cycle  $\gamma$  that is not homologous to zero in  $\mathbb{C}^2 \setminus P$ . As  $\gamma$  we choose the torus  $\{e^{i\varphi}, e^{i\psi}\}$ , where

$0 \leq \varphi, \psi \leq 2\pi$ ; then

$$\int_{\gamma} f dz \wedge dw = \int_{\{|w|=1\}} \int_{\{|z|=1\}} \frac{e^{zw} dz \wedge dw}{(z - 2w)(w - 2z)}.$$

Since  $|w| = 1$ , then to compute the inner integral we need only to consider the residue at the point  $z = w/2$  and, hence, this integral is equal to  $\frac{2\pi i}{3w} e^{w^2/2}$ , and the whole integral is equal to  $-\frac{4}{3}\pi^2$  (from the fact that the integral is different from zero it follows also that  $\gamma$  is not homologous to zero).

We find the linking coefficient  $c(\gamma, \tau) = a$ ; by definition it is equal to the intersection index of  $\gamma$  with the two-dimensional sheet  $T^2$  spanned by  $\tau$ . The parametric equations of  $T^2$  are

$$\left. \begin{aligned} z &= 2t_1 + t_2 \\ w &= t_1 + 2t_2 \end{aligned} \right\}, \quad 0 < t_1, t_2 < \infty,$$

and this sheet intersects the torus  $\gamma$  only in the single point  $(1, 1)$ , which corresponds to the parameter values  $t_1 = t_2 = \frac{1}{3}$ ,  $\varphi = \psi = 0$ . At this point  $\frac{\partial(x, y, u, v)}{\partial(t_1, t_2, \varphi, \psi)} > 0$  (we have set  $z = x + iy, w = u + iv$ ), from which we see that the intersection index  $i(\gamma, T^2) = c(\gamma, \tau) = 1$ . By formula (10) we find that the residue of  $f$  relative to the singular cycle  $\tau$  is equal to

$$R = \frac{1}{(2\pi i)^2} \int_{\gamma} f dz \wedge dw = \frac{1}{3},$$

and then by Theorem 2 we will obtain the value of the desired integral

$$I = -\frac{4\pi^2}{3} c(\sigma, \tau),$$

where  $c(\sigma, \tau)$  is the linking coefficient of the (two-dimensional) cycle of integration  $\sigma$  with the singular (one-dimensional) cycle  $\tau$ .

**54. The theory of Leray.** We consider another method of computing integrals, due to J. LERAY. In a number of cases this method allows us to reduce the computation of the integral of a form  $\omega$  of degree  $r$  over an  $r$ -dimensional cycle  $\sigma$  to the computation of the integral of a form  $\text{res } \omega$  of degree  $r - 1$ , called the residue-form, over some  $(r - 1)$ -dimensional cycle, lying on the manifold of singularities of the form  $\omega$ . Leray's method can also be considered as a generalization of the classical method of residues, which corresponds to the case  $r = 1$  and reduces the computation of integrals of the forms  $\omega = f dz$  over closed curves to the computation of the values of the residues  $\text{res } f$  at the singular points of  $f$  (i.e., zero-dimensional integrals of  $\text{res } f$  over these points). We present this method in its simplest variant.<sup>(18)</sup>

On an  $n$ -dimensional complex manifold  $M$  suppose we are given a submanifold  $P$  of complex codimension 1, which in a neighborhood  $U_{z^0} \subset M$  of any of its points  $z^0$  is given as the set of zeros of a holomorphic function  $\psi_{z^0}$  in this neighborhood such that  $\nabla \psi_{z^0} \neq 0$  in  $U_{z^0}$ :

$$P \cap U_{z^0} = \{z \in U_{z^0} : \psi_{z^0}(z) = 0\}. \tag{1}$$

Suppose that on  $M \setminus P$  we are given a differential form  $\omega$  of degree  $k$ ,  $0 < k \leq 2n$ , of class  $C^\infty$ , having a polar singularity of first order on  $P$ . The

<sup>(18)</sup>For a complete presentation see Leray's paper *Le calcul différentiel et intégral sur une variété analytique complexe (Problème de Cauchy III)*, Bull. Soc. Math. France 87 (1959), no. 2, 81-180, or the book by Aizenberg and Yuzhakov cited in the previous subsection.

last condition means that in each  $U_{z^0}$ ,  $z^0 \in P$ , the product  $\psi_{z^0}\omega$  extends to a  $C^\infty$ -form on  $U_{z^0}$ .

LEMMA. A form  $\alpha \in C^\infty(M)$  is representable in the form<sup>(19)</sup>

$$\alpha = d\psi \wedge \beta \quad (2)$$

in a neighborhood  $U$  of a point  $z^0 \in P$ , where  $\beta \in C^\infty(U)$ , if and only if

$$d\psi \wedge \alpha = 0 \quad (3)$$

in this neighborhood.

◀ We take  $\psi$  to be one of the local coordinates defining  $P$  in the neighborhood  $U$ , say for the variable  $z_1$  (this is possible because of the conditions imposed above on  $\psi$ ). The expression for  $\alpha$  in these coordinates can be divided into two terms:

$$\alpha = \sum \alpha_{i_1 \dots i_p} dZ_{i_1} \wedge \dots \wedge dZ_{i_p} = dz_1 \wedge \beta + \alpha',$$

where  $\alpha'$  does not contain  $dz_1$  (as usual, we set  $Z_\nu = z_\nu$ ,  $Z_{n+\nu} = \bar{z}_\nu$ ,  $\nu = 1, \dots, n$ ). Thus, if  $\alpha$  is representable in the form (2) for  $\psi = z_1$ , then  $\alpha' = 0$ , and hence,  $dz_1 \wedge \alpha = 0$ , i.e., (3) holds. Conversely, if  $dz_1 \wedge \alpha = 0$ , then  $dz_1 \wedge \alpha' = 0$ , and since  $\alpha'$  does not contain  $dz_1$ , this is possible only for  $\alpha' = 0$ . ▶

THEOREM 1. If the form  $\omega \in C^\infty(M \setminus P)$ , having a polar singularity of first order on  $P$ , is closed in  $M \setminus P$ , then in a neighborhood  $U$  of an arbitrary point  $z^0 \in P$  it is representable outside of  $P$  in the form

$$\omega = \frac{d\psi}{\psi} \wedge r + \omega_1, \quad (4)$$

where the forms  $r, \omega_1 \in C^\infty(U)$ . Here the restriction  $r|_P$  does not depend on the choice of the function  $\psi$  and is a closed form.

◀ Since we have  $\psi\omega \in C^\infty(U)$ , then  $d(\psi\omega) = d\psi \wedge \omega + \psi \wedge d\omega$ ; but on  $M \setminus P$  we have  $d\omega = 0$  (since  $\omega$  is closed), and hence, by continuity,  $d(\psi\omega) = d\psi \wedge \omega$  everywhere in  $U$ . Thus,  $d\psi \wedge \omega$  extends on  $P$  to a form  $\alpha \in C^\infty(U)$ , and by the lemma there is a form  $\beta = \omega_1 \in C^\infty(U)$  such that

$$d\psi \wedge \omega = d\psi \wedge \omega_1.$$

Multiplying this equality by  $\psi$ , we will find  $d\psi \wedge (\psi\omega - \psi\omega_1) = 0$ , where  $\psi\omega - \psi\omega_1 \in C^\infty(U)$ ; hence, by the same lemma there exists a form  $r \in C^\infty(U)$  such that  $\psi\omega - \psi\omega_1 = d\psi \wedge r$ . This equality outside of  $P$  is equivalent to (4).

<sup>(19)</sup>To simplify the notation we omit the index  $z^0$  in the notations  $U, \psi$ , and  $\beta$ .

We shall show that the restriction  $r|_P$  is uniquely determined by the form  $\omega$ . We assume first that the function  $\psi$  defining the polar set  $P$  is given, and we shall prove that the equality

$$0 = \frac{d\psi}{\psi} \wedge r + \omega_1 \tag{5}$$

implies the equality  $r|_P = 0$ . But from (5) we will obtain  $d\psi \wedge r + \psi\omega_1 = 0$ , so that  $d\psi \wedge \psi\omega_1 = 0$ , and, since  $\psi$  is a function that is nonzero in  $U \setminus P$ , then  $d\psi \wedge \omega_1 = 0$  there; in view of the fact that  $d\psi \wedge \omega_1 \in C^\infty(U)$ , the last equality also holds everywhere in  $U$ . We can apply the lemma, according to which there is a form  $\omega_2$  such that  $\omega_1 = d\psi \wedge \omega_2$ . Substituting this in (5), we find  $d\psi \wedge (r + \psi\omega_2) = 0$ ; by the same lemma we get  $r + \psi\omega_2 = d\psi \wedge \omega_3$ , where  $\omega_3 \in C^\infty(U)$ . From this we also see that the restriction  $r|_P = 0$ , since we have  $\psi|_P = (d\psi)|_P = 0$ .

We shall now prove the independence of  $r|_P$  from the choice of the function  $\psi$  that defines the polar set. Suppose this set (in the limits of the neighborhood  $U$ ) is defined by another function  $\tilde{\psi}$ ; then the quotient  $\tilde{\psi}/\psi = \chi$  is holomorphic and nonzero in  $U$  (see subsection 50). Suppose we have

$$\omega = \frac{d\tilde{\psi}}{\tilde{\psi}} \wedge \tilde{r} + \tilde{\omega}_1,$$

where  $\tilde{r}, \tilde{\omega}_1 \in C^\infty(U)$ . Substituting  $\tilde{\psi} = \psi\chi$  here, we will find

$$\omega = \frac{d\psi}{\psi} \wedge \tilde{r} + \frac{d\chi}{\chi} \wedge \tilde{r} + \tilde{\omega}_1 = \frac{d\psi}{\psi} \wedge \tilde{r} + \omega_1;$$

here  $\omega_1 = \frac{d\chi}{\chi} \wedge \tilde{r} + \tilde{\omega}_1 \in C^\infty(U)$ , and by what was proved before we have  $\tilde{r}|_P = r|_P$ .

It remains to prove that the form  $r|_P$  is closed. But outside of  $P$  since  $\omega$  is closed we have  $d\omega = -\frac{d\psi}{\psi} \wedge dr + d\omega_1 = 0$ , and this coincides with (5), where  $r$  is replaced by  $-dr$  and  $\omega_1$  by  $d\omega_1$ . By the uniqueness that we just proved, we conclude that  $dr|_P = 0$ . ►

**DEFINITION 1.** The *residue-form* of a closed form  $\omega \in C^\infty(M \setminus P)$ , having a polar singularity of first order on  $P$ , is a closed form on  $P$ , which in a neighborhood of each point  $z^0 \in P$  is equal to the restriction to  $P$  of the form  $r$  in the representation (4):

$$\text{res } \omega = r|_P. \tag{6}$$

Thus, the operator  $\text{res}$  transforms the group  $Z^s(M \setminus P)$  of closed  $C^\infty$ -forms of degree  $s$  into the group  $Z^{s-1}(P)$  of closed  $C^\infty$ -forms of degree  $s - 1$ :

$$\text{res}: Z^s(M \setminus P) \rightarrow Z^{s-1}(P). \tag{7}$$

**REMARK.** If the form  $\omega$  is holomorphic<sup>(20)</sup> on  $M \setminus P$ , then  $\text{res } \omega$  is also holomorphic on  $P$ . This follows from the fact that in case  $\omega$  is holomorphic

<sup>(20)</sup>See subsection 14 for the definition of a holomorphic form.

the forms  $r$  and  $\omega_1$  in the proof of Theorem 1 can also be chosen to be holomorphic.

EXAMPLE. Let  $s$  be equal to the (complex) dimension  $n$  of the manifold  $M$ , and suppose that the form  $\omega$  is holomorphic on  $M \setminus P$  and, in local coordinates  $z = (z_1, \dots, z_n)$  in a neighborhood  $U$  of a point  $z^0 \in P$ , it is representable in the form

$$\omega = \frac{\varphi}{\psi} dz = \frac{\varphi}{\psi} dz_1 \wedge \dots \wedge dz_n, \tag{8}$$

where  $\varphi, \psi \in \mathcal{O}(U)$ , and  $\psi|_P = 0, \frac{\partial \psi}{\partial z_\nu}|_P \neq 0$ . Then we can write

$$\begin{aligned} \omega &= \frac{\varphi}{\partial \psi / \partial z_\nu} (-1)^{\nu-1} \frac{(\partial \psi / \partial z_\nu) dz_\nu}{\psi} \wedge dz[\nu] \\ &= (-1)^{\nu-1} \frac{\varphi}{\partial \psi / \partial z_\nu} \frac{d\psi}{\psi} \wedge dz[\nu]|_P, \end{aligned}$$

from which we see that

$$\text{res } \omega = (-1)^{\nu-1} \frac{\varphi}{\partial \psi / \partial z_\nu} dz[\nu]|_P. \tag{9}$$

(recall that  $dz[\nu] = dz_1 \wedge \dots \wedge dz_{\nu-1} \wedge dz_{\nu+1} \wedge \dots \wedge dz_n$ ). For  $n = 1$  we will obtain the usual formula for the residue at a first-order pole:  $\text{res}_a \frac{\varphi}{\psi} dz = \frac{\varphi(a)}{\psi'(a)}$ .

We pass to a description of the so-called Leray *coboundary operator*  $\delta$ , which to each point  $z^0 \in P$  associates a homeomorph of the circle  $\delta z^0 \subset M \setminus P$  (and thus increases the real dimension by 1). This operator should possess the following properties:

1. In some neighborhood  $U_{z^0}$  there exist local coordinates  $(z_1, \dots, z_n) = z$  with origin  $z^0$ , in which  $P \cap U_{z^0}$  is defined by the equation  $z_n = 0$ , and  $\delta z^0 \subset U_{z^0}$  is defined by the equation  $|z_n| = 1$ .
2. The set  $\bigcup_{z \in P} \delta z$  forms a continuous surface in  $M \setminus P$ .
3. For  $z' \neq z''$  the curves  $\delta z'$  and  $\delta z''$  do not have common points.

Thus, the set  $\bigcup_{z \in P} \delta z$  forms the boundary of a tubular neighborhood of the manifold  $P$  (see the schematic Figure 49, where  $P$  is shown by a curve and  $M$  is represented by three-dimensional space). Under the conditions given above the construction of such an operator  $\delta$  is always possible, since the real dimensions of  $P$  and  $M$  differ by two.

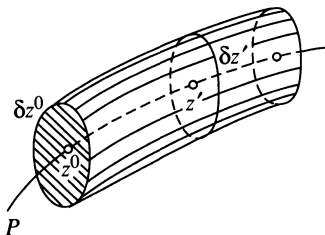

FIGURE 49

Now suppose  $\sigma$  is a cycle on  $P$  of real dimension  $s - 1$ ; assume that the support of this cycle (i.e., the corresponding polyhedron) is COMPACTLY<sup>(21)</sup> contained in  $P$ . We write

$$\delta\sigma = \bigcup_{z \in \sigma} \delta z;$$

we can consider  $\delta\sigma$  as an  $s$ -dimensional chain on  $M \setminus P$  if we introduce a natural orientation in it, corresponding to the orientation of  $\sigma$ . For this it suffices to introduce an orientation on each curve  $\delta z$ , for example as follows: assume that the orientation in the neighborhood  $U_z$  is given by the order of the sequence of local coordinates  $z_1, \dots, z_n$  (the positivity of the form  $dz_1 \wedge \dots \wedge dz_n$ ), and on the manifold  $U_z \cap P$  by the order  $z_1, \dots, z_{n-1}$ ; then going around  $\delta z$  in the positive direction will correspond to the increase of  $t_n$  in the representation  $z_n = e^{it_n}$  of the circle  $\delta z$  (see property 1 of the operator  $\delta$ ).

It is easy to see that the operator  $\delta$  commutes with the operator  $\partial$  of taking the boundary ( $\delta\partial = \partial\delta$ ); therefore it takes cycles into cycles, and cycles homologous to zero into cycles homologous to zero. Thus,  $\delta$  establishes a homomorphism of homology groups

$$\delta: H_{s-1}^{(c)}(P) \rightarrow H_s^{(c)}(M \setminus P) \tag{10}$$

(the sign  $(c)$  in the notation of the groups indicates that we are considering COMPACT homology, i.e., we only consider chains with compact supports).

The following theorem is a generalization of the Cauchy residue theorem from Part I.

**THEOREM 2.** *Let  $\sigma \subset\subset P$  be an  $(s - 1)$ -dimensional cycle and let  $\omega \in C^\infty(M \setminus P)$  be a closed form of degree  $s$ , having  $P$  as a polar set of first order. Then*

$$\int_{\delta\sigma} \omega = 2\pi i \int_{\sigma} \text{res } \omega, \tag{11}$$

where  $\delta$  is the Leray coboundary operator.

◀ We denote by  $\delta_\varepsilon$ ,  $0 < \varepsilon < 1$ , an operator that possesses properties 1–3 of the operator  $\delta$ , with the only difference being that in 1 the equation  $|z_n| = 1$  is replaced by the equation  $|z_n| = \varepsilon$  and as  $\varepsilon \rightarrow 0$  the tubular neighborhood  $\sigma^{(\varepsilon)}$ , bounded by the surface  $\delta_\varepsilon\sigma = \bigcup_{z \in \sigma} \delta_\varepsilon z$ , contracts to  $\sigma$ . By Stokes’s formula (subsection 13) for any  $\varepsilon_1$  and  $\varepsilon_2$ ,  $0 < \varepsilon_1 < \varepsilon_2 < 1$ , we have

$$\int_{\delta_{\varepsilon_2}\sigma} \omega - \int_{\delta_{\varepsilon_1}\sigma} \omega = \int_{\sigma^{(\varepsilon_2)} \setminus \sigma^{(\varepsilon_1)}} d\omega = 0$$

since the form is closed, so that the integral of  $\omega$  over  $\delta_\varepsilon\sigma$  does not depend on  $\varepsilon$ .

---

<sup>(21)</sup>This assumption is necessary to avoid the consideration of improper integrals.

Now we cover  $\sigma^{(1)}$  by a finite number of neighborhoods  $\{U_j\}_{j \in J}$ , in each of which Theorem 1 applies, and, as above, we can take  $\psi(z) = z_n$ . For this covering we construct a partition of unity  $\{e_j\}$  and apply Theorem 1 in each  $U_j$ , in which we set  $\psi = z_n$ ; we obtain

$$\int_{\delta_\varepsilon \sigma} \omega = \sum_{j \in J} \int_{\delta_\varepsilon \sigma} e_j \omega = \sum_{j \in J} \int_{\delta_\varepsilon \sigma} e_j \frac{dz_n}{z_n} \wedge r + \sum_{j \in J} \int_{\delta_\varepsilon \sigma} e_j \omega_1. \quad (12)$$

Here

$$\int_{\delta_\varepsilon \sigma} e_j \frac{dz_n}{z_n} \wedge r = \int_{\{|z_n|=\varepsilon\}} \frac{dz_n}{z_n} \int_{\{z \in \sigma, |z_n|=\varepsilon\}} e_j r'(z, z_n) \rightarrow 2\pi i \int_\sigma e_j \operatorname{res} \omega$$

as  $\varepsilon \rightarrow 0$ , the left-hand side of (12) does not depend on  $\varepsilon$  and is equal to the integral over  $\delta\sigma$ , and the second sum in the right-hand side tends to zero as  $\varepsilon \rightarrow 0$ . Therefore, passing to the limit in (12) as  $\varepsilon \rightarrow 0$ , we obtain

$$\int_{\delta\sigma} \omega = 2\pi i \sum_{j \in J} \int_\sigma e_j \operatorname{res} \omega = 2\pi i \int_\sigma \operatorname{res} \omega. \blacktriangleright$$

We note that if we replace  $\sigma$  by another cycle  $\sigma'$  that belongs to the same compact homology class  $h \in H_{s-1}^{(c)}(P)$  on  $P$  (this means that  $\sigma' - \sigma$  bounds some  $s$ -dimensional chain, compactly contained in  $P$ ), then, since the form  $\operatorname{res} \omega$  is closed, the integrals of it over  $\sigma$  and  $\sigma'$  are the same by Stokes's formula. Considering also that, according to (10), the operator  $\delta$  preserves homology, we can replace the cycles  $\sigma$  and  $\delta\sigma$  in equality (11) by arbitrary representatives of the corresponding classes  $h \in H_{s-1}^{(c)}(P)$  and  $\delta h \in H_s^{(c)}(M \setminus P)$ . Therefore formula (11) can be rewritten in the form

$$\int_{\delta h} \omega = 2\pi i \int_h \operatorname{res} \omega. \quad (13)$$

Furthermore, it is clear that if to  $\omega$  we add an exact form in  $M \setminus P$  (i.e., one which is the differential of some form of degree  $s-1$ ), then the integrals in (13) do not change. The class of forms that differ from  $\omega$  by exact forms is the cohomology class containing  $\omega$ , and the set of such classes for all closed forms  $\omega$  of degree  $s+1$  belonging to  $C^\infty(M \setminus P)$  is the cohomology group  $H^s(M \setminus P)$  (see subsection 14). We see that the cohomology class in  $H^{s+1}(P)$  that contains  $\operatorname{res} \omega$  depends only on the cohomology class in  $H^s(M \setminus P)$  that contains the form  $\omega$ .

**DEFINITION 2.** Let  $\omega$  be some closed form that represents the class  $\omega^* \in H^s(M \setminus P)$ ; the cohomology class in  $H^{s-1}(P)$  that contains the form  $\operatorname{res} \omega$  is called the *residue-class* and is denoted by the symbol  $\operatorname{Res} \omega = \operatorname{Res} \omega^*$ .

Formula (13) can now be rewritten in the form

$$\int_{\delta h} \omega^* = 2\pi i \int_h \operatorname{Res} \omega^*. \quad (14)$$



We can see that the operator  $\text{Res}$  establishes a homomorphism of the corresponding cohomology groups:

$$\text{Res}: H^s(M \setminus P) \rightarrow H^{s-1}(P). \tag{15}$$

We describe in broad lines the case of polar singularities of higher than first order. Suppose again that on an  $n$ -dimensional complex manifold  $M$  we are given a manifold  $P$ , which can be described locally as the set of zeros of a holomorphic function  $\psi$  for which  $\nabla\psi \neq 0$ . We will say that a form  $\omega \in C^\infty(M \setminus P)$  has a *polar singularity of order  $q$*  on  $P$  if the product  $\psi^q \omega$  extends to a  $C^\infty$ -form on  $M$ , and  $\psi^{q'} \omega$ , where  $q' < q$ , does not extend.

We give without proof a theorem which reduces the computation of integrals of closed forms that have a polar singularity of order higher than one on  $P$  to the case that we have already considered (see the books by Leray and by Aizenberg and Yuzhakov cited at the beginning of this subsection):

*For any closed form  $\omega \in C^\infty(M \setminus P)$  with a polar singularity on  $P$ , there is a form  $\omega_0$ , cohomologous to  $\omega$ , which has a singularity of first order on  $P$ .*

The cohomology class in  $H^{s-1}(P)$  that contains  $\text{res}\omega_0$ , i.e., the class  $\text{Res}\omega_0$ , is called the *residue-class* of the form  $\omega$ ; it is determined only by the cohomology class in  $H^s(M \setminus P)$  that contains  $\omega$ .

In the case of the plane the passage from the form  $\omega = f dz$  to  $\omega_0 = f_0 dz$  consists in replacing  $f(z) = c_{-q}/(z-a)^q + \dots + c_{-1}/(z-a)$  by the function  $f_0 = c_{-1}/(z-a)$ , which has a first-order pole at the point  $a$  and the same residue as  $f$ . We note that in the higher-dimensional case for holomorphic  $\omega$  the form  $\omega_0$  will not necessarily be holomorphic, and, more generally, the residue-class  $\text{Res}\omega$  of the holomorphic form  $\omega$  may not contain holomorphic forms.<sup>(22)</sup> This explains the need to consider both holomorphic and  $C^\infty$  forms in Leray's theory.

In practice the case when the form  $\omega$  has several polar manifolds  $P_1, \dots, P_m$  of respective orders  $q_1, \dots, q_m$  is also important. It is assumed that the  $P_\nu$  are in GENERAL POSITION, i.e., that at all points at which they intersect the matrices formed from the derivatives of the functions defining these manifolds have the highest possible rank with respect to the local coordinates. We write  $P^j = (P_1 \cap \dots \cap P_j) \setminus (P_{j+1} \cup \dots \cup P_m)$ ,  $j = 1, \dots, m-1$ ,  $P^m = P_1 \cap \dots \cap P_m$ ,  $P^0 = M \setminus (P_1 \cup \dots \cup P_m)$ , and consider the sequence of homomorphisms  $\delta^j$ , which set up in correspondence to the cycles  $\sigma$  belonging to the compact homology classes in  $H^{(c)}(P^j)$  the cycles  $\delta^j \sigma$  belonging to the classes in  $H^{(c)}(P^{j-1})$ :

$$\delta_m: H^{(c)}(P^m) \xrightarrow{\delta^m} H^{(c)}(P^{m-1}) \rightarrow \dots \rightarrow H^{(c)}(P^1) \xrightarrow{\delta} H^{(c)}(P^0). \tag{16}$$

---

<sup>(22)</sup>From the Remark following Theorem 1 we see that this circumstance can arise only when we are considering forms with a polar singularity of order higher than one.

The cycles  $\delta^j \sigma$  are fibered into homeomorphic circles, going around  $P^j$  and belonging to  $P^{j-1}$ . As above, this sequence is dual to the sequence of homomorphisms of cohomology groups, which defines the *composite residue-class*:

$$\text{Res}^m: H(P^0) \rightarrow H(P^1) \rightarrow \dots \rightarrow H(P^{m-1}) \rightarrow H(P^m). \tag{17}$$

By applying formula (14) successively we obtain the following assertion:

For any  $(s - m)$ -dimensional cycle  $\sigma$  belonging to the homology class  $h \in H_{s-m}^{(c)}(P^m)$  and any closed  $C^\infty$ -form  $\omega$  of degree  $s$  belonging to the cohomology class  $\omega^* \in H^s(P^0)$  the following residue formula holds:

$$\int_{\delta_m h} \omega^* = (2\pi i)^m \int_h \text{Res}^m \omega^*. \tag{18}$$

In conclusion we note that if the form  $\omega$  vanishes on some  $(n - 1)$ -dimensional complex manifold  $N \subset M$ , then the integral of it and the integral of  $\text{res} \omega$  over the intersections  $\sigma \cap N$  and  $\delta \sigma \cap N$  vanish. This gives the possibility of considering RELATIVE homology and cohomology groups instead of the usual groups. We denote by  $C_s(M)$  and  $C_s(N)$  the groups of  $s$ -dimensional chains on these manifolds (as usual, with integer coefficients). A chain  $\sigma \in C_p(M)$  is called a *cycle relative to  $N$*  if its boundary  $\partial \sigma \subset N$  (in particular, is equal to zero). The group  $C_s(N)$  is a subgroup of  $C_s(M)$ ; the quotient group

$$C_s(M, N) = C_s(M)/C_s(N)$$

is called the group of *relative chains*. A chain  $\sigma^s \in C_s(M)$  is called a *relative boundary* if there exists a chain  $\sigma^{s+1} \in C_{s+1}(M)$  such that  $\sigma^s - \partial \sigma^{s+1} \subset C_s(N)$ . The relative boundaries form a subgroup  $B_s(M, N)$  of the group  $Z_s(M, N)$  of all relative cycles; the quotient group

$$H_s(M, N) = Z_s(M, N)/B_s(M, N)$$

is called the *relative homology group*.

In the consideration of forms  $\omega$  that have a polar singularity of first order on the manifold  $P$  and vanish on a manifold  $N$  (they are assumed to lie in general position), one can sometimes make the construction described above more precise. Namely, we add another property to properties 1–3 of the Leray coboundary operator:

4. If  $z \in P \cap N$ , then  $\delta z \subset N$ .

Then this operator transforms each relative cycle  $\sigma \in Z_{s-1}(P, N)$ <sup>(23)</sup> into a relative cycle  $\delta \sigma \in Z_s(M \setminus P, N)$ . It is easy to see that it establishes a homomorphism between the corresponding relative homology groups:

$$\delta: H_{s-1}(P, N) \rightarrow H_s(M \setminus P, N). \tag{19}$$

---

<sup>(23)</sup>By  $Z(P, N)$  we understand  $Z(P, P \cap N)$ ; the analogous convention is also applied in later formulas.

The residue formula (13) remains true for relative homology classes  $h \in H_{s-1}(P, N)$  and  $\delta h \in H_s(M \setminus P, N)$ .

Examples of the application of Leray’s method in the computation of integrals that have an important significance in theoretical physics can be found in the book by R. C. Hwa and V. L. Toeplitz, *Homology and Feynman integrals*, Benjamin, New York and Amsterdam, 1966.

**55. Logarithmic residue.** In subsection 19 we introduced the Poincaré form in  $\mathbb{C}^n$ ,

$$\sigma_0 = \frac{(-1)^n}{\pi^n} d^c \ln|z|^2 \wedge (dd^c \ln|z|^2)^{n-1}, \tag{1}$$

whose integral over any real  $(2n - 1)$ -dimensional cycle  $\gamma \subset \mathbb{C}^n \setminus \{0\}$  gives the index of this cycle.<sup>(24)</sup> A direct computation shows that this form

$$\sigma_0 = \frac{(n - 1)!}{2(2\pi i)^n |z|^{2n}} \left\{ \sum_{\nu=1}^n (-1)^{\nu-1} \bar{z}_\nu dz[\nu] \wedge dz + \sum_{\nu=1}^n (-1)^{\nu-1} z_\nu dz[\nu] \wedge d\bar{z} \right\},$$

i.e., is equal to the real part of the Martinelli-Bochner form:

$$\sigma_0 = \frac{1}{2}(\omega_{MB} + \bar{\omega}_{MB}). \tag{2}$$

The cycle  $\gamma$  is homologous to an integer multiple of the boundary of the polydisc  $U^n = \{\|z\| < 1\}$ , say  $\gamma \sim k\partial U^n$ , and then the index of  $\gamma$  relative to the point  $z = 0$ ,

$$i_0(\gamma) = \int_{k\partial U^n} \omega_{MB} = k \tag{3}$$

(the sign  $\text{Re}$  can be omitted here, since the integral is real). But we obtain the same answer if we replace the entire boundary of the polydisc by its skeleton (distinguished boundary)  $\Gamma$ , and the  $(2n - 1)$ -form  $\omega_{MB}$  by the holomorphic  $n$ -form:

$$i_0(\sigma) = \frac{1}{(2\pi i)^n} \int_{k\Gamma} \frac{dz_1 \wedge \cdots \wedge dz_n}{z_1 \cdots z_n}, \tag{4}$$

where  $k\Gamma$  is an integer multiple of the skeleton  $\Gamma$  of the polydisc. This formula is completely analogous to the formula in the case of the plane for the index of a closed path relative to the point  $z = 0$ .

We arrive at a higher-dimensional analogue of the logarithmic residue if we consider the following problem. Suppose we are given a holomorphic mapping  $f: D \rightarrow \mathbb{C}^n$  of a domain  $D \subset \mathbb{C}^n$ , whose Jacobian  $J_f(z) \neq 0$ ,  $G \subset\subset D$  a domain with a smooth Jordan boundary  $\partial G = S$  that does

<sup>(24)</sup>The form (1) differs from the  $\sigma_0$  in subsection 19 by the factor  $(-1)^n$ , which is related to the fact that here the orientation induced by the form  $dz_1 \wedge \cdots \wedge dz_n \wedge d\bar{z}_1 \wedge \cdots \wedge d\bar{z}_n$  is assumed to be positive, and not that induced by  $dz_1 \wedge d\bar{z}_1 \wedge \cdots \wedge dz_n \wedge d\bar{z}_n$  as in subsection 19.

not contain any zeros of  $f$ . We must determine the common number of zeros of  $f$  in  $G$  counting orders (note that by the theorem on the finiteness of compact analytic sets—Theorem 7 of subsection 24—the condition that  $f \neq 0$  on  $\partial G$  implies that the number of zeros of  $f$  in the domain  $G$  itself is finite).

This problem is solved exactly as in the case of the plane. We compute the index relative to a point  $w = 0$  of the cycle  $S_* = f(S)$ , corresponding to  $S$  under the mapping  $f$ ; by formula (3) and the theorem on changing variables under the integral sign it is equal to

$$N = \frac{(n-1)!}{(2\pi i)^n} \int_S \frac{1}{|f(z)|^{2n}} \sum_{\nu=1}^n (-1)^{\nu-1} \bar{f}_\nu d\bar{f}[\nu] \wedge df. \tag{5}$$

Since the integrand in (5) is a nonsingular form which is closed in  $\bar{G} \setminus \{f(z) = 0\}$ , then by Stokes's formula we can replace the cycle of integration  $S$  by the boundary of the Weil set  $\Pi_\epsilon = \{z \in G: |f_\nu(z)| < \epsilon, \nu = 1, \dots, n\}$  for sufficiently small  $\epsilon > 0$  (see subsection 30). If we make another passage to an integration over the  $n$ -dimensional skeleton  $\Gamma_\epsilon = \{|f_\nu(z)| = \epsilon, \nu = 1, \dots, n\}$  of the set  $\Pi_\epsilon$  like the passage from formula (3) to (4), we obtain

$$N = \frac{1}{(2\pi i)^n} \int_{\Gamma_\epsilon} \frac{df_1 \wedge \dots \wedge df_n}{f_1 \dots f_n}. \tag{6}$$

For sufficiently small  $\epsilon$  the set  $\Pi_\epsilon$  consists of a finite number of connected components, each of which contains exactly one zero of the mapping  $f$ . It is natural to call the integral (5) over the boundary of such a component or the equivalent integral (6) over the skeleton of this component the *order of the zero* of the mapping  $f$  in this component. We will then obtain the following  $n$ -dimensional analogue of the ARGUMENT PRINCIPLE.

**THEOREM 1.** *If  $f: D \rightarrow \mathbb{C}^n$  ( $D \subset \mathbb{C}^n$ ) is a holomorphic mapping,  $J_f(z) \neq 0$ , and  $G \subset\subset D$  is a domain with a Jordan smooth boundary  $S$ , not containing zeros of  $f$ , then the index of  $S_* = f(S)$  relative to the point  $w = 0$  is equal to the common number of zeros of  $f$  in the domain  $G$  counting orders.*

**EXAMPLE 1.** The mapping  $w_1 = z_1^2 - z_2^2$ ,  $w_2 = 2z_1 z_2$  with Jacobian equal to  $4(z_1^2 + z_2^2)$  has a single zero at the point  $(0, 0)$  in the ball  $B = \{|z| < 1\}$  in  $\mathbb{C}^2$ . The order of this zero by formula (6) is equal to

$$N = \frac{1}{(2\pi i)^2} \int_\Gamma \frac{dw_1 \wedge dw_2}{w_1 w_2} = \frac{2}{(2\pi i)^2} \int_\Gamma \frac{(z_1^2 + z_2^2) dz_1 \wedge dz_2}{(z_1^2 - z_2^2) z_1 z_2},$$

where  $\Gamma$  is the skeleton of the Weil domain  $\{|z_1^2 - z_2^2| < 1, 2|z_1 z_2| < 1\}$ . Using Martinelli's method, one can prove that the order  $N = 4$ .

\* 1. Let  $f: U \rightarrow \mathbb{C}^n$  be a holomorphic mapping of a neighborhood of a point  $a \in \mathbb{C}^n$ . Prove that if  $f(a) = 0$  and  $J_f(a) \neq 0$ , then  $f$  has a first-order zero at the point  $a$ .

2. Let  $P_\nu$  be homogeneous polynomials of  $z$  of degree  $d_\nu \geq 1$  for  $\nu = 1, \dots, n$ , and suppose that the mapping  $P = (P_1, \dots, P_n)$  has an isolated zero at the point  $z = 0$ . Prove that the order of this zero is  $d = d_1 \dots d_n$ . [HINT: all the cones  $C_\nu = \{P_\nu(z) = 0\}$  intersect

only in the single point  $z = 0$ ; the set of them is homologous to the set of coordinate planes taken  $d_\nu$  times. Now use formula (6).] \*

From the argument principle, as in the case  $n = 1$ , we obtain

**THEOREM 2 (Rouché).** *Suppose we are given a bounded domain  $D \subset \mathbb{C}^n$  with Jordan boundary  $S$  and two holomorphic mappings  $f, g: \bar{D} \rightarrow \mathbb{C}^n$ . If at each point  $z \in S$  for at least one coordinate we have*

$$|f_\nu(z)| > |g_\nu(z)|, \tag{7}$$

*then the mapping  $f + g$  has as many zeros in  $D$  (counting orders) as  $f$  has there.*

◀ First of all we note that by (7) and the inequality

$$|f_\nu(z) + g_\nu(z)| \geq |f_\nu(z)| - |g_\nu(z)|$$

the mappings  $f$  and  $f + g$  do not have zeros on  $S$  and, hence, the number of zeros they have in  $D$  is finite (Theorem 7 of subsection 24). The mapping  $f_t = f + tg$  also does not have zeros on  $S$  for any  $t \in [0, 1]$ , since for some coordinate there we have

$$|f_\nu + tg_\nu| \geq |f_\nu| - t|g_\nu| > 0.$$

For any  $t \in [0, 1]$  the number  $N_t$  of zeros of  $f_t$  in the domain  $D$  is determined by formula (5), and hence, depends continuously on  $t$ . Since this is an integer-valued function, then  $N_t = \text{const}$ , i.e.,  $f_0 = f$  and  $f_1 = f + g$  have the same number of zeros in  $D$ . ▶

It is clear that if  $\|f\| > \|g\|$  in the Euclidean or polydisc metric on  $S$ , then condition (7) trivially holds.

We note that for  $n > 1$  the order of a zero of a mapping  $f = (f_1, \dots, f_n)$  is not in general expressed via the orders of the lowest terms of the Taylor expansions of the  $f_\nu$  at this zero. Thus, the mapping  $w_1 = z_1^2, w_2 = z_2^3$  has a zero of order 6 for  $z = 0$ , which is equal to the product of the orders. But for the mapping  $w_1 = z_1^2, w_2 = z_1^2 + z_2^3$ , which differs from the preceding mapping by a nondegenerate linear transformation, and hence also has a zero of order 6 at  $z = 0$ , the product of the orders of the lowest terms is equal to 4. The question is clarified using Rouché's theorem.

**THEOREM 3.** *Suppose that a holomorphic mapping  $f: U \rightarrow \mathbb{C}^n$  of a neighborhood of a point  $a \in \mathbb{C}^n$  has an isolated zero at this point. If the mapping  $P = (P_1, \dots, P_n)$ , realized by the lowest nonzero terms of the expansions of the  $f_\nu$  in homogeneous polynomials of  $z$ , also has an isolated zero at  $a$ , then the order of the zero of  $f$  at  $a$  is equal to  $d = d_1 \cdots d_n$ , where  $d_\nu = \text{deg } P_\nu$ .*

◀ Without loss of generality we take  $a = 0$ , and we shall assume that  $\bar{B} = \{|z| \leq 1\} \subset U$  and that  $f$  does not have zeros inside of  $\bar{B}$  except for  $z = 0$ . Set  $f_\nu = P_\nu + g_\nu$ , where  $g_\nu$  is the sum of a series of homogeneous polynomials of degree greater than  $d_\nu$ . By hypothesis the mapping  $P$  has

the unique zero  $z = 0$ , so that there is a constant  $m > 0$  such that at each point  $z$  of the sphere  $S_1 = \{|z| = 1\}$  the largest of  $|P_\nu(z)| \geq m$ . The sum of the moduli of the terms of the series  $g_\nu$  for all  $z \in S_1$  and all  $\nu = 1, \dots, n$  does not exceed some constant  $M < \infty$ .

For a fixed point  $z \in S_1$  we denote by  $\nu_0 = \nu(z)$  the number of the coordinate for which  $\max_\nu |P_\nu(z)|$  is attained. Then for any  $r \in [0, 1]$  we will have

$$|P_{\nu_0}(rz)| \geq r^{d_{\nu_0}} m, \quad |g_{\nu_0}(rz)| \leq r^{d_{\nu_0}+1} M,$$

and hence, if  $r < r_0 = m/M$ , then on the sphere  $S_r = \{|z| = r\}$  we will have  $|P_{\nu_0}(z)| > |g_{\nu_0}(z)|$  at each point. By Rouché's theorem  $f = P + g$  has a zero at  $z = 0$  of the same order as  $P$  does, and by exercise 2 preceding Theorem 2 this order is equal to  $d_1 \cdots d_n$ . ►

Recently A. K. TSIKH and A. P. YUZHAKOV proved that for the multiplicity of an isolated zero of  $f$  and the product of the degrees  $d_\nu$  to coincide it is also necessary that this zero be isolated for the mapping  $P$  of the lowest degrees; in the general case the multiplicity of a zero  $f$  is not less than the product of the  $d_\nu$  (see the book by Aizenberg and Yuzhakov cited in subsection 53).

As yet another application of Rouché's theorem we consider the problem of the local inversion of holomorphic mappings (cf. subsection 35 of Part I):

*Suppose that in a neighborhood  $U$  of a point  $a \in \mathbb{C}^n$  we are given a holomorphic mapping  $f: U \rightarrow \mathbb{C}^n$  and  $f(a) = b$ ; find the inverse mapping to  $f$  in a neighborhood  $V \ni b$ .*

If the Jacobian  $J_f(a) \neq 0$ , then the mapping  $f$  is biholomorphic in some neighborhood of the point  $a$  and the problem has a holomorphic solution  $g = f^{-1}$  at the point  $b$  (see subsection 9). If  $J_f(a) = 0$ , then in addition the so-called *Osgood condition* is required to hold:  $a$  is an isolated point of the set of inverse images of the point  $b = f(a)$ . If this condition does not hold, then  $f^{-1}(b)$  is an analytic set of dimension greater than 0.

**EXAMPLE 2.** The Osgood condition holds at the point  $z = 0$  for the mapping  $f: (z_1, z_2) \rightarrow (z_1^2 - z_2^2, 2z_1 z_2)$ , but not for the mapping  $g: (z_1, z_2) \rightarrow (z_1, z_1 z_2)$ : the inverse image  $g^{-1}(0)$  is the complex line  $\{z_1 = 0\}$ .

**THEOREM 4.** *If the holomorphic mapping  $f: U \rightarrow \mathbb{C}^n$  satisfies the Osgood condition at a point  $a \in U$ , then it is proper in some neighborhood of this point.*

◄ By hypothesis there is a ball  $G = \{|z - a| < r\} \subset\subset U$  such that  $f(z) \neq b$  for  $z \in \overline{G} \setminus \{a\}$ , and hence,  $\min_{z \in \partial G} |f(z) - b| = \rho > 0$ . Let  $B = \{|w - b| < \rho\}$ ; since for any point  $w^0 \in B$  the analytic set  $\{z \in G : f(z) = w^0\}$  does not have points close to  $\partial G$ , then by Theorem 7 of subsection 24 it is finite, i.e., the mapping  $f(z) - w^0$  has isolated zeros in  $G$ . The mapping  $f(z) - b$  has a unique zero in  $G$  (the point  $a$ ), and since

$$f(z) - w^0 = (f(z) - b) + (b - w^0)$$

and  $|f(z) - b| \geq \rho$  on  $\partial G$ , but  $|b - w^0| < \rho$ , then by Rouché's theorem  $f(z) - w^0$  has as many zeros in the Euclidean metric in  $G$  as  $f(z) - b$  does, i.e., at least one zero (considering that  $a$  can be a multiple zero). We have proved that  $B \subset f(G)$ .

We denote by  $G_0$  the connected component of the set  $f^{-1}(B)$  that contains the point  $a$ . Any point  $w \in B$  has a finite number of inverse images in  $G_0$  and for any  $K \subset\subset B$  the inverse image  $f^{-1}(K) \subset\subset G_0$ . This means that the mapping  $f: G_0 \rightarrow B$  is proper. ►

**COROLLARY.** *If  $D$  is a domain in  $\mathbb{C}^n$  and a holomorphic mapping  $f: D \rightarrow \mathbb{C}^n$  satisfies the Osgood condition at each point  $a \in D$ , then  $f(D)$  is also a domain.*

Theorem 4 explains the qualitative nature of local inversion at points at which the Jacobian of a mapping is equal to zero but Osgood's condition does hold: in a neighborhood of the image of such a point inversion acts approximately just like an analytic function of one variable does in a neighborhood of a branch point. For a more detailed study of this we need the following

**THEOREM (Remmert).** *The image of an analytic set in a domain  $D \subset \mathbb{C}^n$  under a proper holomorphic mapping  $f: D \rightarrow G$  is an analytic set in the domain  $G$ .*

This theorem generalizes the obvious assertion concerning the preservation of analytic sets under biholomorphic mappings. We state it without proof.<sup>(25)</sup>

Suppose that a holomorphic mapping  $f$  satisfies Osgood's condition at a point  $a \in \mathbb{C}^n$  and that  $J_f(a) = 0$ . By Theorem 4 there is a neighborhood  $U$  of this point such that  $f: U \rightarrow V$  is a proper mapping. We denote by  $E = \{z \in U: J_f(z) = 0\}$  the set of critical points of the mapping  $f$  (by hypothesis it is not empty). By Remmert's theorem its image  $E_* = f(E)$  is an analytic set in  $V$ , and hence, does not separate  $V$ . Therefore, for any point  $w \in V \setminus E_*$  the number of inverse images  $f^{-1}(w)$  in the domain  $U$  is the same (it is an integer-valued function that is continuous in  $V \setminus E_*$ ); we denote it by  $k$ .

We fix a point  $w^0 \in V \setminus E_*$  and denote by  $z^j(w^0)$  its inverse images in  $U$  ( $j = 1, \dots, k$ ). Carrying out, if necessary, a linear transformation of the space  $\mathbb{C}^n(z)$ , we may assume that the  $n$ th coordinates of the points  $z^j(w^0)$  are different. The same thing is also true for the  $n$ th coordinates  $z_n^j(w)$  of

---

<sup>(25)</sup>See p. 55 of Chirka's book cited in subsection 24. We remark that the theorem is not true for nonproper mappings: the set  $\{2k\pi i + \frac{1}{2k}\}$ , where  $k$  are integers, is analytic in the strip  $\{-1 < \operatorname{Re} z < 1\} \subset \mathbb{C}$  (by the theorem of Weierstrass in subsection 46 of Part I there exists an entire function that defines it), but the image of this set under the holomorphic mapping  $z \rightarrow e^z$  is not analytic, since it has a limit point inside the domain.

the inverse images of points  $w$  that are sufficiently close to  $w^0$ , and we write

$$P(z_n, w) = \prod_{j=1}^k (z_n - z_n^j(w)) \equiv z_n^k + c_1(w)z_n^{k-1} + \dots + c_k(w). \quad (8)$$

By the inverse function theorem, the functions  $z_n^j(w)$ , originally defined in a neighborhood of the point  $w^0$ , can be continued holomorphically along any path in  $V \setminus E_*$ . We note that under continuation along certain closed paths in  $V \setminus E_*$  the final value  $z_n^j(w)$  may not coincide with the initial value, but may pass to the  $n$ th coordinate of another inverse image  $f^{-1}(w)$ . However, the coefficients  $c_\mu(w)$  of the polynomial (8), which are expressed by means of symmetric functions of its roots  $z_n^j(w)$ , do not vary under continuation along such paths, i.e., represent single-valued (and holomorphic) functions in  $V \setminus E_*$ .<sup>(26)</sup> They are obviously bounded, and since  $E_*$  is an analytic set, then by Theorem 3 of subsection 32 they extend holomorphically into the domain  $V$ .

Thus, the  $n$ th coordinate  $z_n = g_n(w)$  of the inversion  $g = f^{-1}$  in the domain  $V$  is a  $k$ -valued analytic function with branch set  $E_* = f(E)$ . In order to find the remaining coordinates of  $g$ , we consider polynomials of  $z_n$  of degree at most  $k - 1$ , defined in  $V \setminus E_*$  by the formulas

$$p_\nu(z_n, w) = \sum_{j=1}^k z_\nu^j(w) \prod_{\substack{\mu=1 \\ \mu \neq j}}^k (z_n - z_n^\mu(w)), \quad \nu = 1, \dots, n - 1, \quad (9)$$

where the  $z_\nu^j(w)$  denote the  $\nu$ th coordinates of  $z^j(w)$ . The coefficients of these polynomials also extend holomorphically into the domain  $V$ . We note that, as we see from (8) and (9),

$$z_\nu^j(w) \frac{\partial P}{\partial z_n} \Big|_{z_n=z_n^j(w)} = z_\nu^j(w) \prod_{\substack{\mu=1 \\ \mu \neq j}}^k (z_n^j(w) - z_n^\mu(w)) = p_\nu(z_n^j(w), w)$$

and hence, the  $\nu$ th coordinates of the inversion  $g$ , i.e.,  $z_\nu^j(w) = g_\nu^j(w)$ , are defined via  $z_n^j(w) = g_n^j(w)$  according to the formulas

$$g_\nu(w) = \frac{p_\nu(z_n, w)}{\frac{\partial}{\partial z_n} P(z_n, w)} \Big|_{z_n=g_n(w)}, \quad \nu = 1, \dots, n - 1. \quad (10)$$

We have proved

**THEOREM 5 (Osgood).** *Let  $f: U \rightarrow \mathbb{C}^n$  be a holomorphic mapping of a neighborhood of a point  $a \in \mathbb{C}^n$ , where  $J_f(a) = 0$ , but  $a$  is an isolated point of the set of inverse images of the point  $b = f(a)$ . Then (possibly after a linear*

<sup>(26)</sup>See the proof of the Weierstrass preparation theorem in subsection 23.



transformation of  $U$ ) a local inversion  $g = f^{-1}$  in a neighborhood of the point  $b$  can be obtained in the following way: its  $n$ th coordinate  $z_n = g_n(w)$  is found from the equation

$$P(z_n, w) = 0, \tag{11}$$

where  $P$  is the polynomial (8) with holomorphic coefficients at  $b$ , and is a  $k$ -valued analytic function in a neighborhood of  $b$ , while the remaining coordinates are uniquely expressed via  $g_n(w)$  and  $w$  according to the formulas (10).

**EXAMPLE 3.** The Jacobian of the mapping

$$w_1 = z_1^2 - z_2^2, \quad w_2 = 2z_1z_2, \tag{12}$$

equal to  $J_f(z) = 4(z_1^2 + z_2^2)$ , vanishes on the complex lines  $E = \{z_1 = \pm iz_2\}$ . Excluding  $z_1$ , we are led to the biquadratic equation  $P(z_2, w) = z_2^4 + w_1z_2^2 - w_2^2/4 = 0$ . The inversion of (12) has the form

$$z_1 = \frac{\sqrt{2}}{2} \sqrt{\sqrt{w_1^2 + w_2^2} + w_1}, \quad z_2 = \frac{\sqrt{2}}{2} \sqrt{\sqrt{w_1^2 + w_2^2} - w_1},$$

so that the functions  $z_\nu(w)$  are four-valued, and their branches are holomorphic outside the set  $E_* = \{w_1 = \pm iw_2\}$ . This set is the image of the set  $E$  and consists of two complex lines, on each of which two values of  $g_\nu$  coalesce; at the intersection point of these planes all four values of  $g_\nu$  coalesce.

When the Osgood condition does not hold, i.e.,  $a$  is a limit point of the set  $f^{-1}(b)$ , but the Jacobian of  $f$  is not identically equal to zero, then there exists an analytic set of complex dimension  $r$ ,  $1 \leq r \leq n - 1$ , containing  $a$ ; this set is transformed by  $f$  to the point  $b$ . In this case, generally speaking,  $b$  is a singular point for at least one component  $g_\nu$  of the inversion of the mapping under consideration.

**EXAMPLE 4.** Consider the mapping

$$w_1 = z_2z_3, \quad w_2 = z_1z_3, \quad w_3 = z_1z_2, \tag{13}$$

whose Jacobian  $J = 2z_1z_2z_3$  vanishes on the three (complex) two-dimensional planes  $\{z_\mu = 0\}$ ,  $\mu = 1, 2, 3$ . The inverse image of the point  $w = 0$  is the set of the three complex lines  $\{z_2 = z_3 = 0\}$ ,  $\{z_1 = z_3 = 0\}$ , and  $\{z_2 = z_1 = 0\}$ . The inversion of (13),

$$z_1 = \sqrt{w_2w_3/w_1}, \quad z_2 = \sqrt{w_1w_3/w_2}, \quad z_3 = \sqrt{w_1w_2/w_3},$$

has holomorphic branches outside the planes  $\{w_\mu = 0\}$ ,  $\mu = 1, 2, 3$ ; the point  $w = 0$  is a singular point for all three components  $g_\mu$ .

### Problems

1. If the function  $f = \frac{P}{Q}$ , where  $P$  and  $Q$  are relatively prime polynomials, is holomorphic in a domain  $D \subset \mathbb{C}^n$ , then  $Q \neq 0$  in this domain.
2. If  $f$  is a function holomorphic in the bidisc  $\{|z| < 1, |w| < 1\}$  and  $f$  does not extend holomorphically to the point  $(z_0, e^{i\theta_0})$ , where  $|z_0| < 1$ , then it also does not extend to all the points  $(z, e^{i\theta_0})$ , where  $|z| < 1$ .
3. Verify that the function  $z^3/(1 - w^2)$ , holomorphic in the ball  $B = \{|z|^2 + |w|^2 < 1\}$ , continuous in  $\bar{B}$  and equal to zero on the line  $z = 0$ , cannot be represented in the form  $z\varphi(z, w)$ , where  $\varphi$  is holomorphic in  $B$  and continuous in  $\bar{B}$ .
4. Let  $D = \{\frac{3}{4} < |z| < \frac{5}{4}, \frac{3}{4} < |w| < \frac{5}{4}\}$  be a domain in  $\mathbb{C}^2$ ; the set  $M = \{(z, w) \in D : w = z + 1\}$  consists of two components:  $M_1 = \{(z, w) \in M : \text{Im } z = \text{Im } w > 0\}$  and

$M_2 = M \setminus M_1$ , which are a positive distance apart from each other. Prove that the second Cousin problem:  $f_1 = 1$  in  $D \setminus M_1$ ,  $f_2 = w - z - 1$  in  $D \setminus M_2$  (compatible data) is not solvable. [HINT: if this were solvable we would obtain a function  $f \in \mathcal{O}(D)$  such that  $f \neq 0$  in  $D \setminus M_1$  and  $g = f/(z - w - 1) \neq 0$  in  $D \setminus M_2$ ; comparing the increases in the arguments  $\Delta'_f$  and  $\Delta''_f$  of the function  $f$  on the circles  $\{|z| = 1, w = \pm 1\}$  and the corresponding increases in the arguments  $\Delta'_g$  and  $\Delta''_g$  of the function  $g$ , we obtain that  $\Delta'_f = \Delta''_f = \Delta'_g$  and  $\Delta'_g = \Delta''_g$ , although it is obvious that  $|\Delta'_f - \Delta'_g| = 2\pi$ .]

5. Prove that in the domain  $D = \mathbb{C}^2 \setminus \{0\}$  the problem  $\bar{\partial}f = (\bar{z}_2 d\bar{z}_1 - \bar{z}_1 d\bar{z}_2)/|z|^2$  is not solvable, although the form in the right-hand side is  $\bar{\partial}$ -closed. [HINT: notice that in the domains  $U_j = \mathbb{C}^2 \setminus \{z_j = 0\}$  the solutions of the problem are  $\bar{z}_1/z_2|z|^2$  and  $-\bar{z}_2/z_1|z|^2$ .]

6. Let  $D$  be a domain of holomorphy in  $\mathbb{C}^n$  and  $\{z \in D: z_1 = 0\} = M_1 \cup M_2$ , where  $M_1$  and  $M_2$  are disjoint open sets on the plane  $z_1 = 0$ ; then there exists a function  $f \in \mathcal{O}(D)$  such that  $f = 1$  on  $M_1$  and the function  $f/z_1$  is holomorphic in a neighborhood of  $M_2$ . [HINT: use the solvability of the  $\bar{\partial}$ -problem.]

7. Let  $X$  be compact, let  $C(X)$  be the ring of all continuous complex-valued functions on  $X$ , let  $G$  be the group (under multiplication) of all functions from  $C(X)$  that are not equal to zero anywhere on  $X$ , and let  $E$  be the subgroup of  $G$  consisting of functions of the form  $e^f$ ,  $f \in C(X)$ . Prove that

$$G/E \approx H^1(X, \mathbb{Z}).$$

This equality also holds in the case when  $X$  is a countable union of compact spaces. (HINT: use the exact sequence  $0 \rightarrow \mathbb{Z} \xrightarrow{e} \mathcal{E} \rightarrow \mathcal{S} \rightarrow 0$ , where  $\mathcal{E}$  and  $\mathcal{S}$  are sheaves of germs of elements of  $C(X)$  and  $G$ , and  $e$  is the mapping  $f \rightarrow e^{2\pi i f}$ .)

8. Let  $K$  be a compact subset of  $\mathbb{C}^n$  and suppose that  $f$  is a holomorphic function in a neighborhood of  $K$ . Assume that  $H^1(K, \mathbb{Z}) = 0$  and  $0 \notin f(K)$ ; then there exists a holomorphic function  $g$  on  $K$  such that  $e^g = f$  (holomorphic logarithm of  $f$ ).

9. Let  $X$  be a compact space, let  $f \in C(X)$ , and let  $N_f = \{x \in X: f(x) = 0\}$ . Assume that  $H^1(X \setminus N_f, \mathbb{Z}) = 0$ ; then for every integer  $k > 0$  the function  $f^{1/k}$  exists in  $C(X)$ .

10. Let  $D$  be a domain of holomorphy in  $\mathbb{C}^n$  and suppose the form  $f$  of class  $C^\infty(D)$  is such that  $df$  is holomorphic in  $D$  (i.e.,  $df$  is a form of bidegree  $(r, 0)$  with holomorphic coefficients); then there exists a form  $g$  of degree  $r - 1$  of class  $C^\infty(D)$  such that the form  $f \rightarrow dg$  is holomorphic.

11. Let  $D$  be a domain in  $\mathbb{C}^n$  for which  $H^1(D, \mathcal{O}) = 0$ , and let  $p: \mathbb{C}^n \rightarrow \mathbb{C}^2$  be the projection onto the first two coordinates. Assume that: (1) there is a holomorphic surface in  $D$  which is projected one-to-one onto  $p(D)$ , and (2) for each  $a \in p(D)$  the set  $p^{-1}(a) \cap D$  is connected and simply connected (i.e., every closed path on it is homotopic to zero); then  $p(D)$  is a domain of holomorphy in  $\mathbb{C}^2$ . [HINT: see Theorem 3 of subsection 48.]

12. (G. M. HENKIN) Prove that in the bidisc  $U \subset \mathbb{C}^2$  the problem  $\bar{\partial}f = \omega$  for the form  $\omega = a_1 d\bar{z}_1 + a_2 d\bar{z}_2$ , for which  $\bar{\partial}\omega = 0$ , is solved by the formula

$$\begin{aligned} 4\pi^2 f(z) = & - \int_U \frac{(\bar{\zeta}_1 - \bar{z}_1)a_1 + (\zeta_2 - \bar{z}_2)a_2}{|\zeta - z|^2} d\bar{\zeta} \wedge d\zeta \\ & + \int_{|\zeta_1|=1} \frac{(\bar{\zeta}_1 - \bar{z}_1)a_1 d\bar{\zeta}_1 \wedge d\zeta}{(\zeta_2 - z_2)|\zeta - z|^2} - \int_{|\zeta_2|=1} \frac{(\bar{\zeta}_2 - \bar{z}_2)a_2 d\bar{\zeta}_2 \wedge d\zeta}{(\zeta_1 - z_1)|\zeta - z|^2}. \end{aligned}$$

13. Let  $D$  be a domain of holomorphy in  $\mathbb{C}^n$  and suppose that the functions  $f_\nu \in \mathcal{O}(D)$ ,  $\nu = 1, \dots, N$ , do not have common zeros in  $D$ ; then there are functions  $g_\nu \in \mathcal{O}(D)$  such that  $f_1 g_1 + \dots + f_N g_N \equiv 1$ .

14. Let  $S = \{z \in \mathbb{C}^3: \operatorname{Re} z_3 = |z_1|^2 - |z_2|^2\}$ ; prove that any smooth function on  $S$ , satisfying the tangential Cauchy-Riemann conditions on  $S$ , extends to an entire function.

15. Let  $f$  be a function of homogeneity  $-4$  with respect to  $w_j$ , which in the affine part of any projective line  $l \subset D_+$  has a single first-order pole. Prove that then the solution of

Maxwell's equations that corresponds to  $f$  by Penrose's method is isotropic (see subsection 52).

16. Using Penrose's method construct an example of a transcendental solution of Maxwell's equations without singularities on real Minkowski space.

17. (A P. YUZHAKOV) Prove that for any cycle  $\sigma$ , not touching the set of singularities of the integrand,

$$\int_{\sigma} \frac{f(z, w)}{az^k + bw^l} dzdw = 0,$$

where  $f$  is an entire function in  $\mathbb{C}^2$ ,  $k$  and  $l$  are relatively prime positive integers, and  $a$  and  $b \in \mathbb{C}$ .

18. Let  $D$  be a domain in  $\mathbb{C}^n$ ,  $n > 1$ , and let  $K$  be a compact subset of  $D$  which does not separate the domain. Prove that any biholomorphic mapping  $f: D \setminus K \rightarrow \mathbb{C}^n$  extends to a biholomorphic mapping of  $D$ .

19. Let  $U$  be an open set in  $\mathbb{C}^n$  and  $f: U \rightarrow \mathbb{C}^m$  a holomorphic mapping. If  $a \in U$  is an isolated point of the inverse images of  $b = f(a)$ , then  $m \geq n$ , and  $m > n$  if and only if there exists a function  $g \neq 0$  that is holomorphic at  $b$  and such that  $g \circ f \equiv 0$  in a neighborhood of  $a$ .

20. Let  $U$  be an open set in  $\mathbb{C}^n$  and  $f: U \rightarrow \mathbb{C}^m$  a holomorphic mapping. If any  $a \in U$  is an isolated point of the set of inverse images of  $f(a)$  and the set  $f(U)$  is open in  $\mathbb{C}^m$ , then  $m = n$ .

21. Prove the following result, called BEZOUT'S THEOREM: if the system of equations  $P_{\nu}(w) = 0$ ,  $\nu = 1, \dots, n$ , where the  $P_{\nu}$  are homogeneous polynomials relative to homogeneous coordinates  $w = (w_0, \dots, w_n)$  in  $\mathbb{P}^n$ , has only isolated roots, then the number of roots (including multiplicities) is equal to the product of the degrees of the  $P_{\nu}$ .

## CHAPTER V

### Some Problems of Geometric Function Theory

In this last chapter, along with classical questions (such as the Bergman and Carathéodory metrics) we also consider a number of new ones, not yet completely explained. It is natural that the material surveyed here reflects to a significant extent the author's personal interests.

#### §19. Invariant metrics

One of the general methods of geometric function theory consists in the use of metrics that are invariant under biholomorphic mappings. Here we shall describe three such metrics. The first of them was proposed by STEFAN BERGMAN in 1933.

**56. The Bergman metric.** In a domain  $D \subset \mathbb{C}^n$  we consider the Hilbert space of holomorphic functions:

$$L^2_{\mathcal{O}}(D) = \left\{ \varphi \in \mathcal{O}(D) : \|\varphi\|_D^2 = \int_D |\varphi|^2 dV < \infty \right\} \quad (1)$$

with the scalar product

$$(\varphi, \psi) = \int_D \varphi \bar{\psi} dV \quad (2)$$

( $dV$  is the volume element). We shall only consider domains for which this space is nontrivial; we shall call them domains of *bounded type* (for example, all bounded domains are of this type, but the space  $\mathbb{C}^n$  is not).

We fix a point  $\zeta \in D$  and minimize the norm  $\|\varphi\|_D$  in the class  $E = \{\varphi \in L^2_{\mathcal{O}}(D) : \varphi(\zeta) = 1\}$ . To prove the solvability of this extremal problem we need

LEMMA 1. *If the polydisc  $U^n(z^0, r) \subset\subset D$ , then, for any  $\varphi \in L^2_{\mathcal{O}}(D)$ ,*

$$|\varphi(z^0)| \leq \frac{1}{\pi^{n/2} r^n} \|\varphi\|_{U^n}. \quad (3)$$

◀ Without loss of generality we assume that  $z^0 = 0$ . If in  $U^n$

$$\varphi(z) = \sum_{|k|=0}^{\infty} c_k z^k,$$

then, setting  $z_\nu = \rho_\nu e^{it_\nu}$ , we will have

$$\begin{aligned} \|\varphi\|_{U^n}^2 &= \int_{U^n} \sum_{k,l} c_k \bar{c}_l z^k \bar{z}^l dV \\ &= \sum_{k,l} c_k \bar{c}_l \prod_{\nu=1}^n \int_0^{2\pi} e^{i(k_\nu - l_\nu)t_\nu} dt_\nu \int_0^{2\pi} \rho_\nu^{k_\nu + l_\nu + 1} d\rho_\nu \\ &= \sum_k |c_k|^2 (2\pi)^n \prod_{\nu=1}^n \frac{r^{2(k_\nu + 1)}}{2(k_\nu + 1)}, \end{aligned}$$

and since the terms of the series are nonnegative, we have  $\|\varphi\|_{U^n}^2 \geq |c_0|^2 \pi^n r^{2n} = |\varphi(0)|^2 \pi^n r^{2n}$ . ►

**THEOREM 1.** *The extremal function of the problem posed above exists and is unique.*

◀ (a) *Existence.* Let  $A = \inf_{\varphi \in E} \|\varphi\|^2$  and let  $\varphi_\mu \in L^2_{\mathcal{O}}(D)$  be a minimizing sequence, i.e.,  $\|\varphi_\mu\|^2 \rightarrow A$ . By Lemma 1 the local uniform boundedness of  $\{\varphi_\mu\}$  follows from this, and then by Montel’s theorem (see subsection 39 of Part I; the proof carries over without difficulty to the case of several variables) we can choose a subsequence  $\{\varphi_{\mu_\nu}\}$  that converges to a function  $\varphi_0 \in L^2_{\mathcal{O}}(D)$  uniformly on compact subsets of  $D$ . For any  $G \subset\subset D$  we have

$$\|\varphi_0\|_G^2 = \lim_{\nu \rightarrow \infty} \|\varphi_{\mu_\nu}\|_G^2 \leq \lim_{\nu \rightarrow \infty} \|\varphi_{\mu_\nu}\|_D^2 = A,$$

and since  $\varphi_0 \in E$ , we have  $\|\varphi_0\|_D^2 = A$ .

(b) *Uniqueness.* Suppose that along with  $\varphi_0$  there is another function  $\psi_0 \in E$  such that  $\|\psi_0\|_D^2 = A$ . Then  $(\varphi_0 + \psi_0)/2 \in E$ , and hence,  $\sqrt{A} \leq \|(\varphi_0 + \psi_0)/2\|$ . By the triangle inequality  $\|(\varphi_0 + \psi_0)/2\| \leq \sqrt{A}$ , and hence,  $\|(\varphi_0 + \psi_0)/2\| = \sqrt{A}$ ; this equality is possible only for  $\psi_0(z) = \lambda\varphi_0(z)$ , where  $\lambda$  is a constant. Substituting  $z = \zeta$ , we find  $\lambda = 1$ , and therefore,  $\psi_0 = \varphi_0$ . ►

By means of the extremal function we define the so-called *kernel function* of the domain

$$k_D(z, \zeta) = \frac{\varphi_0(z, \zeta)}{\|\varphi_0\|_D^2}. \tag{4}$$

We now consider an arbitrary complete orthonormal system of functions  $\varphi_\mu \in L^2_{\mathcal{O}}(D)$  in  $D$ ,  $\mu = 1, 2, \dots$ . “Orthonormality” means the property  $(\varphi_\mu, \varphi_\nu) = \delta_{\mu\nu}$ , where  $\delta_{\mu\nu}$  is the Kronecker symbol, and completeness means that any function  $f \in L^2_{\mathcal{O}}(D)$  is represented by a series

$$f(z) = \sum_{\mu=1}^{\infty} a_\mu \varphi_\mu(z), \tag{5}$$

where  $a_\mu = (f, \varphi_\mu)$ , that converges to  $f$  in mean, i.e., in the sense of the norm (2). We note that in our case Lemma 1 also implies the uniform convergence of the series (5) in each  $G \subset\subset D$ . We also recall that the condition of completeness of an orthonormal system is expressed by *Parseval's equality*

$$\sum_{\mu=1}^{\infty} |a_\mu|^2 = \|f\|_D^2, \quad (6)$$

where  $a_\mu = (f, \varphi_\mu)$ .

By the usual analytic techniques we can prove that in each domain  $D \subset \mathbb{C}^n$  of bounded type there exist complete orthonormal systems in  $L^2_\varphi(D)$ .

**LEMMA 2.** *For any orthonormal system  $\varphi_\mu$  belonging to  $L^2_\varphi(D)$  the series  $\sum_{\mu=1}^{\infty} |\varphi_\mu(z^0)|^2$  converges at any point  $z^0 \in D$ .*

◀ Let  $U(z^0, r) \subset\subset D$  and let  $m$  be an arbitrary natural number; using the orthonormality and inequality (3), we find

$$\begin{aligned} \sum_{\mu=1}^m |\varphi_\mu(z^0)|^2 &= \int_D \left| \sum_{\mu=1}^m \overline{\varphi_\mu(z^0)} \varphi_\mu(z) \right|^2 dV \\ &\geq \int_U \left| \sum_{\mu=1}^m \overline{\varphi_\mu(z^0)} \varphi_\mu(z) \right|^2 dV \geq \pi^n r^{2n} \left( \sum_{\mu=1}^m |\varphi_\mu(z^0)|^2 \right)^2 \end{aligned}$$

(we have applied (3) to the function  $\sum_{\mu=1}^m \overline{\varphi_\mu(z^0)} \varphi_\mu(z) \in L^2_\varphi(D)$ ). It remains to divide by  $\sum_{\mu=1}^m |\varphi_\mu(z^0)|^2$  and to let  $m$  tend to  $\infty$ . ▶

**THEOREM 2.** *In any complete orthonormal system  $\{\varphi_\mu\}$  in the domain  $D$  the kernel function is represented by the series*

$$k_D(z, \zeta) = \sum_{\mu=1}^{\infty} \varphi_\mu(z) \overline{\varphi_\mu(\zeta)}. \quad (7)$$

◀ We write  $\varphi_\mu(\zeta) = \varphi_\mu^0$  and  $\sum_{\mu=1}^{\infty} |\varphi_\mu^0|^2 = \sigma$  (the series converges by Lemma 2). For an arbitrary function  $\varphi(z) = \sum_{\mu=1}^{\infty} a_\mu \varphi_\mu(z) \in E$  (see (5)) we set  $a_\mu = \frac{1}{\sigma} (\overline{\varphi_\mu^0} + \gamma_\mu)$ ; then we obtain from the condition  $\sum_{\mu=1}^{\infty} a_\mu \varphi_\mu^0 = 1$  that  $\sum_{\mu=1}^{\infty} \gamma_\mu \varphi_\mu^0 = 0$ . Taking this into account Parseval's equality (6) gives

$$\|\varphi\|_D^2 = \frac{1}{\sigma^2} \left( \sigma + \sum_{\mu=1}^{\infty} |\gamma_\mu|^2 \right) \geq \frac{1}{\sigma};$$

the minimal value of  $\|\varphi\|_D^2$ , equal to  $1/\sigma$ , is attained if all the  $\gamma_\mu = 0$ , i.e.,

$$\varphi_0(z, \zeta) = \frac{1}{\sigma} \sum_{\mu=1}^{\infty} \overline{\varphi_\mu(\zeta)} \varphi_\mu(z), \quad \frac{1}{\sigma} = \|\varphi_0\|_D^2.$$

Substituting this into (4), we will obtain (7). ▶

**COROLLARY.** *The kernel function  $k(z, \zeta)$ :*

(a) *is holomorphic in the first coordinate and antiholomorphic in the second;*

(b) *is antisymmetric:  $k(\zeta, z) = \overline{k(z, \zeta)}$ ;*

(c) *is reproducing: for any  $\varphi \in L^2_{\varphi}(D)$  at any point  $z \in D$*

$$\varphi(z) = \int_D \varphi(\zeta)k(z, \zeta) dV_{\zeta}. \tag{8}$$

◀ **Properties (a) and (b)** are seen from formula (7). For the proof of (c) we remark that in view of the Cauchy-Bunyakovskii inequality  $\sum |a_{\mu}\varphi_{\mu}| \leq \sqrt{\sum |a_{\mu}|^2} \sqrt{\sum |\varphi_{\mu}|^2}$  the series (5) converges absolutely and uniformly on compact subsets of  $D$ , so that, considering the orthonormality of the system, we obtain

$$\begin{aligned} \int_D \varphi(\zeta)k(z, \zeta) dV &= \sum_{\mu, \nu=1}^{\infty} a_{\mu}\varphi_{\nu}(z) \int_D \varphi_{\mu}(\zeta)\overline{\varphi_{\nu}(\zeta)} dV \\ &= \sum_{\mu=1}^{\infty} a_{\mu}\varphi_{\mu}(z) = \varphi(z). \blacktriangleright \end{aligned}$$

Formula (7) allows us to compute the kernel function of the simplest domains.

**EXAMPLES.**

1. The POLYDISC  $U = \{z \in \mathbb{C}^n : \|z\| < 1\}$ . An example of a complete orthonormal system here is the system of normalized monomials  $\varphi_k(z) = \lambda_k z^k$ , where  $k = (k_1, \dots, k_n)$ ,  $k_{\nu} \geq 0$ , and the coefficients  $\lambda_k > 0$  are chosen from the condition

$$(\varphi_k, \varphi_k) = \lambda_k^2 \int_U z^k \overline{z^k} dV = 1.$$

Introducing polar coordinates ( $z_{\nu} = \rho_{\nu} e^{i\theta_{\nu}}$ ) in each plane  $z_{\nu}$ , we find from this condition that

$$(2\pi)^n \lambda_k^2 \prod_{\nu=1}^n \int_0^1 \rho_{\nu}^{2k_{\nu}+1} d\rho_{\nu} = \pi^n \lambda_k^2 \prod_{\nu=1}^n \frac{1}{k_{\nu} + 1} = 1$$

or

$$\lambda_k^2 = \frac{1}{\pi^n} \prod_{\nu=1}^n (k_{\nu} + 1).$$

The completeness of the system  $\varphi_k$  follows from the fact that a series in this system is a Taylor series, and all functions  $f \in \mathcal{O}(U)$  are represented by it; its orthogonality is obvious.

By formula (7) we will obtain as a consequence that

$$k(z, \zeta) = \sum_{|k| \geq 0} \lambda_k^2 z^k \overline{\zeta^k} = \frac{1}{\pi^n} \sum_{|k| \geq 0} \prod_{\nu=1}^n (k_{\nu} + 1) (z_{\nu} \overline{\zeta_{\nu}})^{k_{\nu}}.$$

Setting  $z_{\nu} \overline{\zeta_{\nu}} = x_{\nu}$ , we notice that

$$\prod_{\nu=1}^n (k_{\nu} + 1) x_{\nu}^{k_{\nu}} = \frac{\partial}{\partial x_1} \dots \frac{\partial}{\partial x_n} (x_1^{k_1+1} \dots x_n^{k_n+1}) = \frac{\partial}{\partial x} x^{k+1},$$

and, since  $|x| < 1$ , we can change the order of differentiation and summation of the series, and we obtain

$$k(z, \zeta) = \frac{1}{\pi^n} \frac{\partial}{\partial x} \frac{1}{1-x} = \frac{1}{\pi^n} \frac{1}{(1-x)^2},$$

or in explicit notation

$$k_U(z, \zeta) = \frac{1}{\pi^n} \prod_{\nu=1}^n \frac{1}{(1 - z_\nu \bar{\zeta}_\nu)}. \tag{9}$$

2. The BALL  $B = \{z \in \mathbb{C}^n : |z| < 1\}$ . The system of monomials  $\lambda_k z^k$  will again be a complete orthonormal system, but the normalization conditions give  $\lambda_k^2 = (|k| + n)! / k! \pi^n$ , and we need to introduce polar coordinates (in  $\mathbb{R}^{2n}$ ) to compute the integral over  $B$ . By formula (7) we obtain

$$k(z, \zeta) = \frac{1}{\pi^n} \sum_{|k| \geq 0} \frac{(|k| + n)!}{k!} z^k \bar{\zeta}^k = \frac{1}{\pi^n} \sum_{\mu=0}^\infty (\mu + 1) \cdots (\mu + n) \sum_{|k|=\mu} \frac{\mu!}{k!} z^k \bar{\zeta}^k.$$

Now we note that the inner sum

$$\sum_{|k|=\mu} \frac{\mu!}{k_1! \cdots k_n!} (z_1 \bar{\zeta}_1)^{k_1} \cdots (z_n \bar{\zeta}_n)^{k_n} = \left( \sum_{\nu=1}^n z_\nu \bar{\zeta}_\nu \right)^\mu$$

and that

$$\sum_{\mu=0}^\infty (\mu + 1) \cdots (\mu + n) t^\mu = \frac{\partial^n}{\partial t^n} \frac{1}{1 - t} = \frac{n}{(1 - t)^{n-1}}$$

for all  $t, |t| < 1$ . Since  $t = \sum_{\nu=1}^n z_\nu \bar{\zeta}_\nu$  here is less than 1 in modulus, then

$$k_B(z, \zeta) = \frac{n!}{\pi^n (1 - \sum_{\nu=1}^n z_\nu \bar{\zeta}_\nu)^{n+1}}. \tag{10}$$

REMARK. From formula (9) we see that the kernel function of the polydisc is the product of the kernel functions of the discs  $\{|z_\nu| < 1\}$ , which are equal to  $1/\pi(1 - z_\nu \bar{\zeta}_\nu)^2$ . One can prove that more generally the kernel function of a product of domains  $D \subset \mathbb{C}^m(z)$  and  $G \subset \mathbb{C}^n(w)$  is equal to the product of the kernel functions of these domains:<sup>(1)</sup>

$$k_{D \times G}(z, w; \zeta, \omega) = k_D(z, \zeta) k_G(w, \omega). \tag{11}$$

DEFINITION 1. The Bergman function of a domain  $D \subset \mathbb{C}^n$  is

$$K_D(z) = k_D(z, z) = \sum_{\mu=1}^\infty |\varphi_\mu(z)|^2. \tag{12}$$

In domains of bounded type this function is positive, since, according to (4), it is the inverse of the quantity  $\inf \|\varphi\|_D^2$  in the class of functions  $\varphi \in L^2_\varphi(D)$ , normalized by the condition  $\varphi(z) = 1$ .

THEOREM 3. The differential form

$$dd^c \ln K = \frac{i}{2} \sum_{\mu, \nu=1}^n \frac{\partial^2 \ln K}{\partial z_\mu \partial \bar{z}_\nu} dz_\mu \wedge d\bar{z}_\nu, \tag{13}$$

where  $K = K_D(z)$  is the Bergman function of the domain  $D$ , is invariant under biholomorphic mappings of this domain.

◀ Let  $f: D \rightarrow G = f(D)$  be a biholomorphic mapping. If  $\psi_\mu \in L^2_\varphi(G)$  is an orthonormal system in  $G$ , then  $\varphi_\mu = \psi_\mu \circ f \cdot J_f$ , where  $J_f$  is the Jacobian

<sup>(1)</sup>See B. A. Fuks, *Special chapters in the theory of analytic functions of several complex variables*, Fizmatgiz, Moscow, 1963, p. 91; English transl., Transl. Math. Monographs, vol. 14, Amer. Math. Soc., Providence, RI, 1965.



of  $f$ , is an orthonormal system in  $D$ . In fact, since the volume element of the image is  $dV_* = |J_f|^2 dV$ , then

$$\int_D \varphi_\mu \overline{\varphi_\nu} dV = \int_D \psi_\mu \circ f \cdot \overline{\psi_\nu \circ f} \cdot |J_f|^2 dV = \int_G \psi_\mu \overline{\psi_\nu} dV_* = \delta_{\mu\nu}.$$

The system  $\{\varphi_\mu\}$  is complete along with  $\{\psi_\mu\}$ , since any  $\varphi \in L^2_\varnothing(D)$  can be represented in the form  $\varphi = \psi \circ f \cdot J_f$ , where  $\psi \in L^2_\varnothing(G)$ , and then from the expansion  $\psi = \sum_{\mu=1}^\infty a_\mu \psi_\mu$  we will find  $\varphi = \sum_{\mu=1}^\infty a_\mu \varphi_\mu$ . Thus, by Theorem 2,

$$K_D(z) = \sum_{\mu=1}^\infty |\varphi_\mu(z)|^2 = \sum_{\mu=1}^\infty |\psi_\mu \circ f(z)|^2 |J_f(z)|^2 = K_G \circ f(z) \cdot |J_f(z)|^2.$$

Taking the logarithm of this equality, we find

$$\ln K_G(w) = \ln K_D(z) - \ln J_f(z) - \overline{\ln J_f(z)},$$

where  $w = f(z)$ , and it only remains to see that  $\overline{\partial} \ln J_f = \partial \overline{\ln J_f} = 0$  since  $J_f$  is holomorphic, and  $dd^c = \frac{i}{2} \partial \overline{\partial}$ . ▶

The bilinear form

$$ds^2 = \sum_{\mu, \nu=1}^n \frac{\partial^2 \ln K}{\partial z_\mu \partial \overline{z}_\nu} dz_\mu d\overline{z}_\nu = \sum_{\mu, \nu=1}^n g_{\mu\nu} dz_\mu d\overline{z}_\nu \tag{14}$$

corresponding to (13) is called the *Bergman form* of the domain  $D$ .

**THEOREM 4.** *In bounded domains  $D \subset \mathbb{C}^n$  the Bergman form is Hermitian and positive definite.*

◀ That the form is Hermitian, i.e., that  $g_{\nu\mu} = \overline{g_{\mu\nu}}$ , follows directly from (14) if we take into account that  $K > 0$ . To prove that it is positive definite we fix a point  $z^0 \in D$ , pass a complex line  $l: z = z^0 + \omega\zeta$  through it, where  $\omega \in \mathbb{C}^n$ ,  $\zeta \in \mathbb{C}$ , and we note that by the chain rule for the restriction of  $K \circ l$  we have

$$\left. \frac{\partial^2 \ln K \circ l}{\partial \zeta \partial \overline{\zeta}} \right|_{\zeta=0} = \sum_{\mu, \nu=1}^n \left. \frac{\partial^2 \ln K}{\partial z_\mu \partial \overline{z}_\nu} \right|_{z=z^0} \omega_\mu \overline{\omega}_\nu.$$

Consequently, we need to prove that the quantity on the left is positive for any  $\omega \in \mathbb{C}^n$ ,  $\omega \neq 0$ .

A direct computation, based on formula (12), gives

$$\left. \frac{\partial^2 \ln K \circ l}{\partial \zeta \partial \overline{\zeta}} \right|_{\zeta=0} = \frac{1}{K^2(z^0)} \left\{ \sum |\varphi_\mu|^2 \cdot \sum |\varphi'_\mu|^2 - \sum \varphi'_\mu \overline{\varphi}_\mu \sum \varphi_\mu \overline{\varphi'_\mu} \right\}, \tag{15}$$

where on the right-hand side the notation  $\varphi_\mu = \varphi_\mu(z^0)$ ,  $\varphi'_\mu = \frac{d}{d\zeta} \varphi_\mu \circ l|_{\zeta=0}$  is used and the summation is taken over  $\mu$  from 1 to  $\infty$ . We consider

$\Phi = (\varphi_1, \dots, \varphi_\mu, \dots)$  and  $\Phi' = (\varphi'_1, \dots, \varphi'_\mu, \dots)$  as points of the Hilbert space of sequences  $l^2$ . Then (15) can be rewritten in the form

$$\frac{\partial^2 \ln K \circ l}{\partial \zeta \partial \bar{\zeta}} \Big|_{\zeta=0} = \frac{1}{K^2(z^0)} \{ |\Phi|^2 |\Phi'|^2 - |(\Phi, \Phi')|^2 \},$$

where  $(\Phi, \Phi')$  is the scalar product in  $l^2$ , and by the Cauchy-Bunyakovskii inequality the quantity in curly braces is nonnegative. It vanishes only in the case when  $\Phi = \lambda \Phi'$  for some  $\lambda \in \mathbb{C}$ , and, since  $|\Phi|^2 = K(z^0) \neq 0$ , then  $\lambda \neq 0$ . In this case for any function  $\varphi \in L^2_{\mathcal{O}}(D)$  we have

$$\varphi(z^0) = \sum_{\mu=1}^{\infty} a_{\mu} \varphi_{\mu} = \lambda \sum_{\mu=1}^{\infty} a_{\mu} \varphi'_{\mu} = \lambda \frac{d}{d\zeta} \varphi \circ l \Big|_{\zeta=0}.$$

In particular, for the function  $\varphi(z) = \sum_{\nu=1}^n \bar{\omega}_{\nu}(z_{\nu} - z^0_{\nu})$ , which belongs to  $L^2_{\mathcal{O}}(D)$  since the domain  $D$  is bounded, we have  $\varphi \circ l = |\omega|^2 \zeta$  and the last relation gives  $0 = \lambda |\omega|^2$ , which is impossible for  $\omega \neq 0$ . ►

REMARK. Theorem 4 extends to those unbounded domains  $D \subset \mathbb{C}^n$  for which  $L^2_{\mathcal{O}}(D)$  contains all the linear functions.

The positive definiteness of the Bergman form means that the function  $\ln K$  is strictly plurisubharmonic (subsection 38). Since the plurisubharmonicity of  $K$  also follows from this, then from Theorem 4 of subsection 39 we also find

**THEOREM 5.** *If the domain  $D \subset \mathbb{C}^n$  is such that its Bergman function  $K_D$  grows unboundedly when approaching the boundary, then  $D$  is a domain of holomorphy.*

**DEFINITION 2.** The Hermitian metric that is defined in the domain  $D \subset \mathbb{C}^n$  by the fundamental form (14) is called the *Bergman metric*.

By Theorem 3 this metric is invariant under biholomorphic mappings: if  $b_D(z, w)$  is the distance between two points  $z, w \in D$  in this metric and  $f: D \rightarrow G = f(D)$  is a biholomorphic mapping, then

$$b_D(z, w) = b_G(f(z), f(w)), \tag{16}$$

where  $b_G$  is the distance in the Bergman metric of the domain  $G$ .

**EXAMPLE 1.** For the polydisc  $U = \{ \|z\| < 1 \} \subset \mathbb{C}^n$  by formula (9) the Bergman metric is defined by the form

$$ds^2 = 2 \sum_{\nu=1}^n \frac{dz_{\nu} d\bar{z}_{\nu}}{(1 - |z_{\nu}|^2)^2}, \tag{17}$$

and for the ball  $B = \{ |z| < 1 \} \subset \mathbb{C}^n$  by formula (10)

$$ds^2 = (n + 1) \left\{ \frac{|dz|^2}{1 - |z|^2} + \sum_{\mu, \nu=1}^n \frac{\bar{z}_{\mu} z_{\nu} dz_{\mu} d\bar{z}_{\nu}}{(1 - |z|^2)^2} \right\}, \tag{18}$$

where  $|dz|^2 = \sum_{\nu=1}^n |dz_{\nu}|^2$ . For  $n = 1$  both metrics coincide with the Lobachevskii metric in the unit disc (see subsection 11 of Part I).

We point out the formula for the distance from the origin in the Bergman metric for the unit ball

$$b_B(0, z) = \sqrt{n+1} \ln \frac{1+|z|}{1-|z|}. \tag{19}$$

It is obtained if we assume (without loss of generality) that  $z = (z_n)$  and integrate (18) along a line segment.

Finally, we indicate the formula for the distance in the Bergman metric of the unit polydisc  $U \subset \mathbb{C}^n$  from 0 to a point  $z = (|z_1|, \dots, |z_n|)$  with nonnegative coordinates (this does not restrict generality). One can prove that the geodesic joining the points 0 and  $z$  is a path  $\gamma: [0, 1] \rightarrow U$ , the projection of whose points onto the plane  $z_\nu$  ( $\nu = 1, \dots, n$ ) moves with constant velocity  $v_\nu$  (in the Lobachevskii metric) along a geodesic in this plane, i.e., a segment of the  $x_\nu$  axis:

$$\ln \frac{1+x_\nu(t)}{1-x_\nu(t)} = v_\nu t, \quad v_\nu = \ln \frac{1+|z_\nu|}{1-|z_\nu|}.$$

From this we find  $2dx_\nu/(1-x_\nu^2(t)) = v_\nu dt$  and by formula (17) we will obtain

$$b_U(0, z) = \sqrt{2} \int_0^1 \sqrt{\sum_{\nu=1}^n \frac{dx_\nu^2}{(1-x_\nu^2(t))^2}} dt = \frac{1}{\sqrt{2}} \sqrt{\sum_{\nu=1}^n \ln^2 \frac{1+|z_\nu|}{1-|z_\nu|}}. \tag{20}$$

**57. The Carathéodory metric.** In bounded domains of  $\mathbb{C}^n$ , and also on some complex manifolds, one can also introduce another metric, which is invariant under biholomorphic mappings. This metric was introduced by C. CARATHÉODORY in 1927. To describe it we consider the set  $\mathcal{O}(M, U)$  of holomorphic mappings of a complex manifold  $M$  into the unit disc  $U \subset \mathbb{C}$ , and we adopt the following

**DEFINITION.** The *Carathéodory distance* between points  $p, q \in M$  is defined by

$$c_M(p, q) = \sup_{\varphi \in \mathcal{O}(M, U)} \rho(\varphi(p), \varphi(q)), \tag{1}$$

where  $\rho$  is the Lobachevskii distance in the unit disc; for points  $z, w \in U$  it is equal to

$$\rho(z, w) = \ln \frac{|1 - \bar{w}z| + |z - w|}{|1 - \bar{w}z| - |z - w|} \tag{2}$$

(see subsection 11 of Part I).

**THEOREM 1.** *On any complex manifold  $M$  the function  $c_M$  is defined and is a semimetric, i.e., it is nonnegative and satisfies the symmetry condition  $c_M(p, q) = c_M(q, p)$  and the triangle inequality  $c_M(p, q) \leq c_M(p, r) + c_M(r, q)$ .*

◀ We shall first prove that for any  $p, q \in M$  the upper bound (1) is finite. By definition there exists a sequence  $\varphi^\mu \in \mathcal{O}(M, U)$  such that  $\rho(\varphi^\mu(p), \varphi^\mu(q)) \rightarrow c_M(p, q)$ , and without loss of generality we may assume  $\varphi^\mu(q) = 0$  for all  $\mu$  (by an auxiliary automorphism of the disc we can map  $\varphi^\mu(q)$  to 0). Then

$$\rho(\varphi^\mu(p), 0) = \ln \frac{1+|\varphi^\mu(p)|}{1-|\varphi^\mu(p)|}. \tag{3}$$

Since the functions  $\varphi^\mu$  are bounded, then by Montel's theorem (see subsection 39 of Part I; the proof of this theorem carries over to manifolds without difficulty) there is a subsequence that converges  $\varphi^{\mu_k} \rightarrow \varphi \in \mathcal{O}(M, U)$  uniformly on compact subsets of  $M$ . If  $\varphi = \text{const}$ , then  $\varphi \equiv 0$ , since  $\varphi^\mu(q) = 0$ , and then the assertion is trivial. If  $\varphi \neq \text{const}$ , then by the maximum principle there is a point  $p' \in M$  such that  $|\varphi(p)| < |\varphi(p')| \leq 1$ . But then  $|\varphi(p)| < 1$  and from (3) we see that again  $c_M(p, q) < \infty$ . Thus, the function  $c_M$  is defined on any complex manifold.

Furthermore, the nonnegativity and symmetry of  $c_M$  are obvious, and in order to prove the triangle inequality we take the function  $\varphi \in \mathcal{O}(M, U)$  constructed above, for which  $c_M(p, q) = \rho(\varphi(p), \varphi(q))$ . By the definition of the Carathéodory metric we have  $c_M(p, r) \geq \rho(\varphi(p), \varphi(r))$  and  $c_M(r, q) \geq \rho(\varphi(r), \varphi(q))$ , and by the triangle inequality for the Lobachevskii metric

$$\rho(\varphi(p), \varphi(q)) \leq \rho(\varphi(p), \varphi(r)) + \rho(\varphi(r), \varphi(q)). \quad \blacktriangleright$$

In the general case  $c_M$  is only a SEMIMETRIC since  $c_M(p, q)$  can vanish for  $p \neq q$ . For example, this will happen if  $M = \mathbb{C}^n$  or  $\mathbb{C}^n \setminus N$ , where  $N$  is a complex manifold (here any holomorphic mapping  $\varphi: M \rightarrow U$  is constant by Liouville's theorem and the theorem on the removal of singularities of bounded holomorphic functions). The same thing will also be true for all compact complex manifolds (by the maximum principle).

For the Carathéodory semimetric  $c_M$  to be a METRIC, i.e.,  $c_M(p, q) = 0$  only if  $p = q$ , it is obviously necessary and sufficient that the bounded holomorphic functions on  $M$  separate the points of  $M$  (i.e., for arbitrary distinct points  $p, q \in M$  there should exist a bounded holomorphic function  $\varphi$  on  $M$  such that  $\varphi(p) \neq \varphi(q)$ ).

EXAMPLE 2. In the ball  $B = \{|z| < 1\} \subset \mathbb{C}^n$  the distance

$$c_B(0, z) = \ln \frac{1 + |z|}{1 - |z|} \quad (4)$$

coincides up to a scalar multiple with the distance in the Bergman metric (see the preceding subsection). In the polydisc  $U = \{\|z\| < 1\} \subset \mathbb{C}^n$  the Carathéodory distance

$$c_U(0, z) = \max_{\nu} \ln \frac{1 + |z_{\nu}|}{1 - |z_{\nu}|} \quad (5)$$

( $\nu = 1, \dots, n$ ) is different from the Bergman metric. From this example we also see that the Carathéodory metric is in general not smooth, like the Bergman metric.

Formulas (4) and (5) are easily proved using the Schwarz lemma for  $\mathbb{C}$ -homogeneous metrics (Theorem 3 of subsection 9).

**THEOREM 2** (contractibility property). *Holomorphic mappings  $f: M \rightarrow N$  do not increase the Carathéodory metric:*

$$c_N(f(p), f(q)) \leq c_M(p, q) \quad (6)$$

for arbitrary points  $p, q \in M$ .

◀ Let  $\psi \in \mathcal{O}(N, U)$  be such that

$$c_N(f(p), f(q)) = \rho(\psi \circ f(p), \psi \circ f(q))$$

(its existence is proved in the proof of Theorem 1). Then  $\psi \circ f \in \mathcal{O}(M, U)$ , and since there are other functions in  $\mathcal{O}(M, U)$ , then  $c_M(p, q) \geq \rho(\psi \circ f(p), \psi \circ f(q))$ . ►

This theorem generalizes the so-called SCHWARZ LEMMA in its invariant formulation, which is stated as:

*A holomorphic mapping  $f: U \rightarrow U$  of the unit disc into itself does not increase the Lobachevskii distance:*

$$\rho(f(z), f(w)) \leq \rho(z, w). \quad (7)$$

If  $w = f(w) = 0$ , then (7) reduces to the usual Schwarz lemma:

$$\ln \frac{1 + |f(z)|}{1 - |f(z)|} \leq \ln \frac{1 + |z|}{1 - |z|} \quad \text{or} \quad |f(z)| \leq |z|.$$

We point out some simple consequences of Theorem 2.

**COROLLARY 1.** *The Carathéodory metric is invariant relative to biholomorphic mappings  $f$ .*

◀ It suffices to apply Theorem 2 to the mappings  $f$  and  $f^{-1}$ . ►

**COROLLARY 2.** *If  $M$  and  $N$  are complex manifolds and  $M \subset N$ , then for all points  $p, q \in M$*

$$c_N(p, q) \leq c_M(p, q). \quad (8)$$

◀ It suffices to apply Theorem 2 to the embedding  $i: M \rightarrow N$ , which to each point  $p \in M$  associates the same point  $p \in N$ . ►

**REMARK.** In the preceding subsection we saw that the Bergman metric is also invariant under biholomorphic mappings. However, in contrast to the Carathéodory metric, it does not possess the contractibility property for HOLOMORPHIC mappings. Indeed, consider a holomorphic mapping  $f: (z_1, z_2) \rightarrow (z_1, z_1)$  of the bidisc  $U \subset \mathbb{C}^2$  into itself. By formula (20) of the preceding subsection for  $z = (z_1, 0)$  we have

$$b_U(0, z) = \frac{1}{\sqrt{2}} \ln \frac{1 + |z_1|}{1 - |z_1|},$$

$$b_U(0, f(z)) = \ln \frac{1 + |z_1|}{1 - |z_1|} > b_U(0, z).$$

We remark in conclusion that the Carathéodory metric, like the Bergman metric, can be defined locally. For this we fix a point  $z$  in the domain  $D \subset \mathbb{C}^n$ , a tangent vector  $v = \sum \alpha_\nu \frac{\partial}{\partial z_\nu} \in T_z^c(D)$  (subsection 27) and we define the quantity

$$\Phi(z, v) = 2 \sup |v(\varphi)| = 2 \sup \left| \sum_{\nu=1}^n \alpha_\nu \frac{\partial \varphi}{\partial z_\nu} \right|, \quad (9)$$

where the supremum is taken over the set  $\mathcal{O}_z(D, U)$  of all holomorphic mappings  $\varphi: D \rightarrow U$ ,  $\varphi(z) = 0$ . In addition, define the Carathéodory length

of the piecewise-smooth path  $\gamma: I \rightarrow M$  by the integral

$$\|\gamma\|_c = \int_0^1 \Phi(\gamma(t), \gamma'(t)) dt, \quad (10)$$

and the *distance*  $\tilde{c}_D(z, w)$  between points  $z, w \in D$  is defined as the infimum of the Carathéodory lengths of all piecewise-smooth paths joining these points in  $D$ .

According to the earlier definition

$$c_D(z, w) = \sup_{\varphi \in \mathcal{O}_z(D, U)} \ln \frac{1 + |\varphi(w)|}{1 - |\varphi(w)|},$$

and if the point  $w$  is close to  $z$ , then  $|\varphi(w)|$  is small, and up to quantities of higher orders of smallness  $c_D(z, w) \approx 2 \sup |\varphi(w)|$ . If the point  $w$  is approximated to  $z$  along the path  $\gamma$  such that  $\gamma(0) = z$ ,  $\gamma'(0) = v$ , then the differential of  $c_D(z, w)$  is equal to  $2 \sup \left| \frac{\partial \varphi}{\partial v} \right| dt = 2 \sup |v(\varphi)| dt$  (see subsection 27). Thus, locally both definitions of the Carathéodory length coincide, but in the general case the quantities  $c_D(z, w)$  and  $\tilde{c}_D(z, w)$  may not be the same.

\* (1) Prove that in the definition (9) of the quantity  $\Phi$  the condition  $\varphi(z) = 0$  can be dropped, i.e., it holds automatically. [HINT: apply Schwarz's lemma for one variable.]

(2) Prove that for the domain  $D = \{z \in \mathbb{C}^2: 1/2 < |z| < 1\}$  the quantity  $c_D(z, w)$  is equal to the restriction to  $D$  of the quantity  $c_B(z, w)$ , where  $B = \{z \in \mathbb{C}^2: |z| < 1\}$ .

(3) Explain why the quantities  $c_D(z, w)$  and  $\tilde{c}_D(z, w)$ , where  $z = (-3/4, 0)$  and  $w = (3/4, 0)$ , are different for the domain  $D$  from (2). \*

**58. The Kobayashi metric.** Comparatively recently, in 1967, S. KOBAYASHI proposed a modification of the Carathéodory metric, which has a number of advantages. The basis of Kobayashi's definition is not  $\mathcal{O}(M, U)$ , but the set  $\mathcal{O}(U, M)$  of holomorphic mappings of the unit disc  $U$  into the manifold  $M$ . (We note that there is already an advantage in making this change: for example, if  $M$  is a compact manifold, then by the maximum principle all holomorphic functions on it are constant, i.e.,  $\mathcal{O}(M, U)$  consists entirely of constants, while  $\mathcal{O}(U, M)$  also contains nonconstant mappings.) Here we present Kobayashi's principal results.

We fix points  $p, q \in M$  and we call a *chain* on  $M$  from  $p$  to  $q$  a set  $\sigma$ , consisting of  $m$  holomorphic discs  $f^j \in \mathcal{O}(U, M)$  and  $m$  pairs of points  $\zeta'_j, \zeta''_j \in U$  ( $j = 1, \dots, m$ ) such that  $f^1(\zeta'_1) = p$ ,  $f^m(\zeta''_m) = q$ , and  $f^j(\zeta''_j) = f^{j+1}(\zeta'_{j+1})$  for  $j = 1, \dots, m-1$  (see Figure 50 on the next page).

DEFINITION. The *Kobayashi distance* between two points  $p, q \in M$  is

$$k_M(p, q) = \inf_{\sigma} \sum_{j=1}^m \rho(\zeta'_j, \zeta''_j), \quad (1)$$

where  $\rho$  is the Lobachevskii distance in the unit disc and the infimum is taken over all chains  $\sigma = \{f^j, \zeta'_j, \zeta''_j\}_{j=1}^m$  on  $M$  from  $p$  to  $q$  (with an arbitrary number of links  $m$ ).

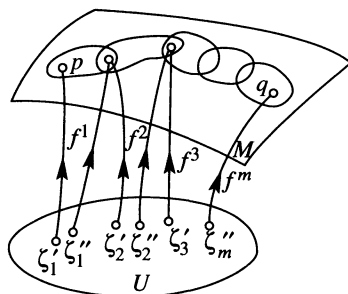

FIGURE 50

**THEOREM 1.** *On any complex manifold  $M$  the Kobayashi distance  $k_M$  possesses the properties of a semimetric.*

◀ The nonnegativity of  $k_M$  is obvious. To prove the symmetry property  $k_M(p, q) = k_M(q, p)$  it is sufficient, along with the chain  $\sigma$ , to consider a chain which is obtained from it by replacing  $j$  by  $m + 1 - j$  and  $\zeta'_j$  by  $\zeta''_j$ . For the proof of the triangle inequality

$$k_M(p, q) \leq k_M(p, r) + k_M(r, q)$$

it suffices to consider, along with chains  $\sigma'$  from  $p$  to  $r$  and  $\sigma''$  from  $r$  to  $q$ , their union  $\sigma$ , which is a chain from  $p$  to  $q$ :

$$\sum_{\sigma} \rho(\zeta'_j, \zeta''_j) = \sum_{\sigma'} \rho(\zeta'_j, \zeta''_j) + \sum_{\sigma''} \rho(\zeta'_j, \zeta''_j),$$

and since there also exist other chains from  $p$  to  $q$ , then  $k_M(p, q)$  does not exceed the sum of the infima over the chains  $\sigma'$  and  $\sigma''$ . ▶

\* Prove that in the definition of the Kobayashi distance in the general case it is impossible to replace a chain by a single disc, i.e., to assume that  $m = 1$ . Namely, if  $D = \{z \in \mathbb{C}^2: |z_1| < 2, |z_2| < 2, |z_1 z_2| < \varepsilon\}$  and if for points  $z, w \in D$  we set

$$\tilde{k}(z, w) = \inf_{f \in \mathcal{O}(U, D)} \{\rho(\zeta', \zeta'') : f(\zeta') = z, f(\zeta'') = w\},$$

then for sufficiently small  $\varepsilon > 0$  for the points  $z = (1, 0)$ ,  $w = (0, 1)$ , and  $0 = (0, 0)$  the triangle inequality will not hold. [HINT:  $\tilde{k}(z, 0)$  and  $\tilde{k}(w, 0)$  remain bounded for  $\varepsilon \rightarrow 0$ , but  $\tilde{k}(z, w) \rightarrow \infty$ .] \*

**THEOREM 2.** *Holomorphic mappings  $f: M \rightarrow N$  do not increase Kobayashi distances:*

$$k_N(f(p), f(q)) \leq k_M(p, q). \tag{2}$$

◀ For any holomorphic curve  $\varphi \in \mathcal{O}(U, M)$  we can consider the curve  $f \circ \varphi \in \mathcal{O}(U, N)$ , but there are also other curves in  $\mathcal{O}(U, N)$ . Therefore the infimum in the left-hand side of (2) does not exceed the infimum in the right-hand side. ▶

As in the previous subsection, we obtain two corollaries from this.

**COROLLARY 1.** *The Kobayashi metric is invariant under biholomorphic mappings.*

**COROLLARY 2.** *If  $M$  and  $N$  are complex manifolds and  $M \subset N$ , then  $k_N(p, q) \leq k_M(p, q)$ .*

For the unit disc the Kobayashi metric, like the other metrics we have considered, coincides with the Lobachevskii metric. The following two theorems stress the remark made above concerning the advantages of the Kobayashi metric. The first of them asserts that the Kobayashi distance on a manifold  $M$  is the LARGEST of those distances that do not increase for holomorphic mappings of the unit disc  $U$  into  $M$ .

**THEOREM 3.** *If  $d$  is a semimetric on  $M$  such that  $d(f(\zeta'), f(\zeta'')) \leq \rho(\zeta', \zeta'')$  for all holomorphic mappings  $f: U \rightarrow M$ , then  $d(p, q) \leq k_M(p, q)$  for all  $p, q \in M$ .*

◀ Let  $\sigma = (f^j, \zeta'_j, \zeta''_j)_{j=1}^m$  be an arbitrary chain on  $M$  from  $p$  to  $q$ . By the triangle equality for  $d$  we have

$$d(p, q) \leq \sum_{j=1}^m d(f^j(\zeta'_j), f^j(\zeta''_j));$$

$f^j$  does not increase distances, so that  $d(f^j(\zeta'_j), f^j(\zeta''_j)) \leq \rho(\zeta'_j, \zeta''_j)$  for  $j = 1, \dots, m$ . It remains to take the infimum over all chains on  $M$  from  $p$  to  $q$  on the right. ▶

In an analogous way, one proves that the Carathéodory distance  $c_M$  is the SMALLEST of those that do not increase distances for holomorphic mappings of  $M$  into  $U$ .

**THEOREM 4.** *On any complex manifold  $M$  the Carathéodory distance does not exceed the Kobayashi distance:*

$$c_M(p, q) \leq k_M(p, q). \quad (3)$$

◀ We fix points  $p, q \in M$ , a chain  $\sigma = \{f^j, \zeta'_j, \zeta''_j\}_{j=1}^m$ , and a holomorphic mapping  $\varphi$  of the manifold  $M$  into the unit disc  $U$ . By the Schwarz lemma in its invariant formulation (see the preceding subsection)

$$\sum_{j=1}^m \rho(\zeta'_j, \zeta''_j) \geq \sum_{j=1}^m \rho[\varphi \circ f^j(\zeta'_j), \varphi \circ f^j(\zeta''_j)] \geq \rho(\varphi(p), \varphi(q))$$

(we have again used the triangle inequality for the Lobachevskii metric and the fact that  $f^1(\zeta'_1) = p$ ,  $f^m(\zeta''_m) = q$ ). It remains to take the supremum over  $\varphi$  on the right and the infimum of  $\sigma$  on the left. ▶

The Kobayashi metric also admits a local definition. Fix a point  $p$  of a complex manifold  $M$ , a tangent vector  $v \in T_p(M)$ , and consider all the possible holomorphic mappings  $f$  of the disc  $U_R = \{|z| < R\}$  into the



manifold  $M$ , normalized by the conditions  $f(0) = p$ ,  $f'(0) = v$ . We denote by  $\Phi_M$  the inverse of the supremum of the radii of the discs for which such mappings exist:

$$\Phi_M(p, v) = \frac{1}{\sup\{R : \exists f \in \mathcal{O}(U_R, M), f(0) = p, f'(0) = v\}}. \quad (4)$$

Using the function  $\Phi_M$  in a standard way we define the distance:

$$\tilde{k}_M(p, q) = \inf \int_0^1 \Phi_M(\gamma(t), \gamma'(t)) dt, \quad (5)$$

where the infimum is taken over all piecewise-smooth paths  $\gamma: [0, 1] \rightarrow M$ ,  $\gamma(0) = p$ ,  $\gamma(1) = q$ . H. Royden proved<sup>(2)</sup> that for any complex manifold  $M$  this construction is the same as the Kobayashi semimetric:  $\tilde{k}_M(p, q) = k_M(p, q)$ .

\* Let  $B = \{z \in \mathbb{C}^n : |z| < 1\}$  and  $D = \{(0, z_n) : |z_n| < 1\}$ ; prove that  $\Phi_D(p, v) = \Phi_B(p, v)$  for  $p \in D$  and  $v = (0, z_n)$ . \*

A complex manifold  $M$  is said to be *hyperbolic*<sup>(3)</sup> if the Kobayashi semimetric  $k_M$  for it is a metric, i.e.,  $k_M(p, q) \neq 0$  for  $p \neq q$ . According to Theorem 4 the class of hyperbolic manifolds is broader than the class of manifolds with a nontrivial Carathéodory metric. In the following section we consider the basic properties of such manifolds.

## §20. Hyperbolic manifolds

**59. Criteria for hyperbolicity.** We consider the connection between Kobayashi metrics on a manifold and its coverings.

LEMMA 1. *Let  $M$  be a complex manifold and  $\pi: \tilde{M} \rightarrow M$  a holomorphic covering<sup>(4)</sup> of  $M$ ; then for any points  $p, q \in M$*

$$k_M(p, q) = \inf k_{\tilde{M}}(\tilde{p}, \tilde{q}), \quad (1)$$

where for any fixed  $\tilde{p} \in \pi^{-1}(p)$  the infimum is taken over all  $\tilde{q} \in \pi^{-1}(q)$ .

◀ Since the projection  $\pi$  is holomorphic, by the contractibility property (Theorem 2 of the preceding subsection)  $k_M(p, q) \leq \inf k_{\tilde{M}}(\tilde{p}, \tilde{q})$ . Suppose, on the other hand, that there exists an  $\varepsilon > 0$  such that

$$k_M(p, q) + \varepsilon < \inf k_{\tilde{M}}(\tilde{p}, \tilde{q}). \quad (2)$$

<sup>(2)</sup>See H. L. Royden, *Remarks on the Kobayashi metric*, Several Complex Variables. II (Proc. Internat. Conf., Univ. Maryland, College Park, MD, 1970), Lecture Notes in Math., vol. 185, Springer, Berlin, 1971, pp. 125–137.

<sup>(3)</sup>This name was suggested by the theory of Riemann surfaces, in which hyperbolic surfaces are those that are biholomorphically equivalent to the unit disc, and the surfaces that are biholomorphically equivalent to the complex plane are called parabolic. One can introduce an invariant metric on hyperbolic surfaces by means of the Lobachevskii metric, and it is nontrivial.

<sup>(4)</sup>This means that  $\tilde{M}$  is also a complex manifold and  $\pi$  is a holomorphic mapping (see Chapter II).

Then there is a chain  $\sigma = \{f^j, \zeta'_j, \zeta''_j\}_{j=1}^m$  on  $M$  from  $p$  to  $q$  such that

$$\sum_{j=1}^m \rho(\zeta'_j, \zeta''_j) < k_M(p, q) + \varepsilon. \tag{3}$$

We denote by  $\tilde{f}^j: U \rightarrow \tilde{M}$  the liftings<sup>(5)</sup> of the curves  $f^j: U \rightarrow M$  to the covering  $\tilde{M}$  such that  $\tilde{f}^1(\zeta'_1) = \tilde{p}$ , where  $\tilde{p}$  is a fixed point, and  $\tilde{f}^{j+1}(\zeta'_{j+1}) = \tilde{f}^j(\zeta''_j)$ ,  $j = 1, \dots, m - 1$ . Then  $\tilde{q} = \tilde{f}^m(\zeta''_m) \in \pi^{-1}(q)$  and  $\tilde{\sigma} = \{\tilde{f}^j, \zeta'_j, \zeta''_j\}_{j=1}^m$  is a chain on  $\tilde{M}$  from  $\tilde{p}$  to  $\tilde{q}$ . By the definition of the Kobayashi metric and inequality (3) we have

$$k_{\tilde{M}}(\tilde{p}, \tilde{q}) \leq \sum_{j=1}^m \rho(\zeta'_j, \zeta''_j) < k_M(p, q) + \varepsilon,$$

which contradicts (2). ►

EXAMPLE 1. The Lobachevskii metric in the upper half-plane  $H = \{z = x + iy \in \mathbb{C} : y > 0\}$  is given by the form  $ds^2_H = dzd\bar{z}/y^2$  (see subsection 11 of Part I), and  $H$  covers the punctured unit disc  $U_* = \{0 < |\zeta| < 1\}$  with the projection  $\zeta = \pi(z) = e^{2\pi iz}$ . Substituting  $dz = \frac{1}{2\pi i} \frac{d\zeta}{\zeta}$  and  $y = \frac{1}{2\pi} \ln \frac{1}{|\zeta|}$ , we find by Lemma 1 the Kobayashi metric of the punctured disc:

$$ds^2_{U_*} = \frac{d\zeta d\bar{\zeta}}{|\zeta|^2 \ln^2 \frac{1}{|\zeta|}}. \tag{4}$$

We note that in this metric the length of the circle  $\{|\zeta| = r\}$  is equal to  $2\pi/\ln \frac{1}{r}$  and tends to zero as  $r \rightarrow 0$ .

THEOREM 1. *A complex manifold  $M$  is hyperbolic if and only if a holomorphic covering  $\tilde{M}$  of it is hyperbolic.*

◀ (a) Suppose  $M$  is hyperbolic and  $k_{\tilde{M}}(\tilde{p}, \tilde{q}) = 0$ . Then by the lemma we also have  $k_M(\pi(\tilde{p}), \pi(\tilde{q})) = 0$ , and in view of the hyperbolicity  $\pi(\tilde{p}) = \pi(\tilde{q})$ ; we denote this point by  $p$ . Let  $B = \{p' \in M : k_M(p', p) < \varepsilon\}$  and let  $\tilde{B}$  be a neighborhood of  $\tilde{p}$  that is so small that the mapping  $\pi: \tilde{B} \rightarrow B$  is biholomorphic.<sup>(6)</sup> We take a chain  $\tilde{\sigma} = \{\tilde{f}^j, \zeta'_j, \zeta''_j\}_{j=1}^m$  on  $\tilde{M}$  from  $\tilde{p}$  to  $\tilde{q}$  such that

$$\sum_{j=1}^m \rho(\zeta'_j, \zeta''_j) < \varepsilon \tag{5}$$

(since  $k_{\tilde{M}}(\tilde{p}, \tilde{q}) = 0$ ).

In the disc  $U$  we construct Lobachevskian geodesic arcs  $\widehat{\zeta'_j \zeta''_j}$  and we consider the path  $\tilde{\gamma} = (\tilde{f}^1(\widehat{\zeta'_1 \zeta''_1}), \dots, \tilde{f}^m(\widehat{\zeta'_m \zeta''_m}))$  on  $\tilde{M}$ , and also its projection  $\gamma = \pi \circ \tilde{\gamma}$  onto  $M$ . Since the mapping  $\pi \circ \tilde{f}^j: U \rightarrow M$  is contracting, the

<sup>(5)</sup>This means that  $\pi \circ \tilde{f}^j = f^j$ ; see Chapter II. Just as in subsection 17 we can prove that the lifting  $\tilde{f}^j$  of the curve  $f^j$  exists and is uniquely determined by giving one point of  $\tilde{f}^j$ .

<sup>(6)</sup>Here we have used the fact that the Kobayashi metric induces a topology on  $M$  (see Problem 14 at the end of the chapter).

$k_M$ -length of the arc  $\pi \circ \tilde{f}^j(\zeta'_j, \zeta''_j)$  does not exceed  $\rho(\zeta'_j, \zeta''_j)$ , and hence, in view of (5), the  $k_M$ -length of the path  $\gamma$  is less than  $\varepsilon$ . Since the origin of the path  $\gamma$  coincides with  $p$ , it follows from this that  $\gamma \subset B$ .

But the origin  $\tilde{p}$  of the path  $\tilde{\gamma}$  belongs to  $\tilde{B}$ , and  $\pi: \tilde{B} \rightarrow B$  is biholomorphic, and hence,  $\tilde{\gamma} \subset \tilde{B}$ . The end  $\tilde{q}$  of the path  $\tilde{\gamma}$  is projected to  $p$ , and in  $\tilde{B}$  there is only one point with such a projection, the point  $\tilde{p}$ . Hence,  $\tilde{q} = \tilde{p}$ , and we have proved that  $k_{\tilde{M}}$  is a metric, i.e., that  $\tilde{M}$  is hyperbolic.

(b) Let  $\tilde{M}$  be hyperbolic and  $k_M(p, q) = 0$ . We take  $\tilde{p} \in \pi^{-1}(p)$ ; then by the lemma there is a sequence  $\tilde{q}_\nu \in \pi^{-1}(q)$  such that  $k_{\tilde{M}}(\tilde{q}_\nu, \tilde{p}) \rightarrow 0$ . By the hyperbolicity  $\tilde{q}_\nu \rightarrow \tilde{p}$ , and hence,  $\pi(\tilde{q}_\nu) \rightarrow p$ . But  $\pi(\tilde{q}_\nu) = q$ , and hence,  $q = p$  and  $M$  is hyperbolic. ►

EXAMPLES.

2. We consider the sphere  $\bar{\mathbb{C}}$  with  $p$  distinct points deleted

$$D_p = \bar{\mathbb{C}} \setminus \{z_1, \dots, z_p\}.$$

Its universal covering for  $p = 1$  and 2 is conformally equivalent to the plane  $\mathbb{C}$ , and for  $p > 2$  to the unit disc  $U$  (see subsection 21). By Theorem 1 it follows from this that  $D_p$  is hyperbolic if and only if  $p > 2$ .

We remark that the Carathéodory metric in  $D_p$  is trivial for all  $p$ , since any holomorphic mapping  $f: D_p \rightarrow U$  is constant by the theorem on the removability of singularities of bounded functions and Liouville's theorem.

3. Suppose that in  $\mathbb{P}^2$  we are given four complex lines  $l_j$  ( $j = 1, \dots, 4$ ) in general position,  $a = l_1 \cap l_2$  and  $b = l_3 \cap l_4$  the points of intersection, and  $l_0$  the complex line passing through  $a$  and  $b$ . The manifold  $M = \mathbb{P}^2 \setminus \bigcup_{j=0}^4 l_j$  is hyperbolic.<sup>(7)</sup>

In fact, without loss of generality we may assume  $l_0$  to be the line at infinity, so that  $\mathbb{P}^2 \setminus l_0 = \mathbb{C}^2$  and  $M = \mathbb{C}^2 \setminus \bigcup_{j=1}^4 l_j$ . Since  $a, b \in l_0$ , i.e., are points at infinity, then  $l_1$  is parallel to  $l_2$  and  $l_3$  is parallel to  $l_4$  (in  $\mathbb{C}^2$ ), and since the lines are in general position, then  $l_1$  is not parallel to  $l_3$ . Therefore we may assume that our lines in  $\mathbb{C}^2$  are given respectively by the equations  $z_1 = 0, z_1 = 1$  and  $z_2 = 0, z_2 = 1$ . But then  $M$  is the product of two copies of the hyperbolic manifold  $\mathbb{C} \setminus \{0, 1\} = \bar{\mathbb{C}} \setminus \{0, 1, \infty\}$ , and hence, is hyperbolic. The last assertion follows from the following easily proved inequality: if  $M_1$  and  $M_2$  are complex manifolds, and  $p_1, q_1 \in M_1$  and  $p_2, q_2 \in M_2$ , then

$$\begin{aligned} & \max(k_{M_1}(p_1, q_1), k_{M_2}(p_2, q_2)) \\ & \leq k_{M_1 \times M_2}((p_1, p_2), (q_1, q_2)) \leq k_{M_1}(p_1, q_1) + k_{M_2}(p_2, q_2). \end{aligned} \tag{6}$$

The following results are due to PETER KIERNAN. Let  $M$  be a complex manifold, consider a point  $p \in M$ , let  $z = (z_1, \dots, z_n)$ ,  $z(p) = 0$ , be local coordinates on  $M$  in a neighborhood of  $p$ , and let  $B_r = \{p' \in M : |z(p')| < r\}$ ,  $B_1 = B$ ; suppose also that  $U_\delta = \{|\zeta| < \delta\}$ ,  $U_1 = U$  are discs on  $\mathbb{C}$ .

LEMMA 2. *If there exist numbers  $r$  and  $\delta$  such that for all holomorphic mappings  $f: U \rightarrow M$  the condition  $f(0) \in B_r$  implies that  $f(U_\delta) \subset B$ , then for all  $q \in M \setminus B$  the Kobayashi distance  $k_M(p, q) > 0$ .*

<sup>(7)</sup>P. Kiernan obtained this result: The manifold  $M = \mathbb{P}^n \setminus \bigcup_{j=1}^{2n+1} H_j$ , where the  $H_j$  are hyperplanes in general position, is hyperbolic. (See P. Kiernan, *Hyperbolically imbedded spaces and the big Picard theorem*, Math. Ann. **204** (1973), no. 3, 203–209.)

◀ Let  $q \in M \setminus B$  and let  $\sigma = \{f^j, \zeta'_j, \zeta''_j\}_{j=1}^m$  be a chain on  $M$  from  $p$  to  $q$ ; carrying out auxiliary Lobachevskii motions in  $U$ , we may assume that all the  $\zeta'_j = 0$ . We need to prove that for all such chains the lengths  $|\sigma| = \sum_{j=1}^m \rho(0, \zeta''_j)$  are bounded from below by a positive constant.

If in the chain  $\sigma$  there is a point  $\zeta''_j \notin U_{\delta/2}$ , then  $|\sigma| \geq \rho(0, \delta/2) > 0$ , and hence it suffices to consider chains for which all  $\zeta''_j \in U_{\delta/2}$ . We write  $p_j = f^j(\zeta''_j) = f^{j+1}(0)$ ; there is a number  $l$ ,  $1 \leq l \leq m$ , such that  $p_1, \dots, p_{l-1} \in B_r$ , and  $p_l \notin B_r$ . Since  $f^l(0) = p_{l-1} \in B_r$  and  $\zeta''_l \in U_\delta$ , then by the hypothesis of the lemma  $f^l(\zeta''_l) = p_l \in B$ , and hence,  $p_l \in B \setminus B_r$ . We choose a constant  $\lambda > 0$  such that for all  $\zeta \in U_{\delta/2}$  the Lobachevskii distance  $\rho_U(0, \zeta) \geq \lambda \rho_{U_\delta}(0, \zeta)$ . Since  $f^j$ ,  $1 \leq j \leq l$ , maps  $U_\delta$  holomorphically into  $B$ , then by the contractibility property of the Kobayashi metric and the triangle inequality we have

$$\sum_{j=1}^m \rho(0, \zeta''_j) \geq \lambda \sum_{j=1}^l \rho_{U_\delta}(0, \zeta''_j) \geq \lambda \sum_{j=1}^l k_B(p_{j-1}, p_j) \geq \lambda k_B(p, p_l).$$

Since  $k_B$  is a metric and  $p_l \in B \setminus B_r$ , the quantity on the right-hand side is bounded from below by a positive constant that does not depend on the chain. ▶

As before let  $\mathcal{O}(U, M)$  be the family of holomorphic mappings from the unit disc  $U$  into a complex manifold  $M$ .

**THEOREM 2.** *If in some metric  $d$  that induces the topology on  $M$  the family  $\mathcal{O}(U, M)$  is equicontinuous, then  $M$  is a hyperbolic manifold. Conversely, if  $M$  is a hyperbolic manifold, then  $\mathcal{O}(U, M)$  is equicontinuous in the Kobayashi metric  $k_M$ .*

◀ Suppose that  $\mathcal{O}(U, M)$  is equicontinuous in the metric  $d$  and let  $B_\varepsilon^d(p) = \{p' \in M : d(p', p) < \varepsilon\}$ . For any point  $q \in M$ , different from  $p$ , we take local coordinates  $z$  with center  $p$ , as in Lemma 2 (so that  $q \notin B$ ), and we choose  $\varepsilon > 0$  so that  $B_{2\varepsilon}^d(p) \subset B$ . By the equicontinuity there is a  $\delta > 0$  such that for any  $f \in \mathcal{O}(U, M)$  for which  $f(0) \in B_\varepsilon^d(p)$ , we certainly have  $f(U_\delta) \subset B_{2\varepsilon}^d(p) \subset B$ . If we also take  $r > 0$  such that  $B_r \subset B_\varepsilon^d(p)$ , then the hypothesis of Lemma 2 will be satisfied, and hence,  $d_M(p, q) > 0$ . We have proved that  $M$  is hyperbolic.

The second assertion of the theorem follows from the fact that holomorphic mappings do not increase the Kobayashi metric. ▶

The complex manifolds  $M$  for which the family  $\mathcal{O}(U, M)$  is equicontinuous in some metric that induces the topology on  $M$  are termed *tight* in the literature. We will say that a complex manifold  $M$  possesses the *Montel property* if the family  $\mathcal{O}(U, M)$  is NORMAL, i.e., from any sequence

$f^\nu \in \mathcal{O}(U, M)$  we can extract a subsequence  $f^{\nu_j}$  that either converges uniformly on compact subsets of  $U$  or diverges compactly (this means that, for any compact subsets  $K \subset U$  and  $K' \subset M$  there is a  $j_0$  such that  $f^{\nu_j}(K) \cap K' = \emptyset$  for all  $j \geq j_0$ ). In the literature manifolds possessing this property are termed *taut*.

**THEOREM 3.** *If a manifold  $M$  possesses the Montel property, then it is hyperbolic.*

◀ If  $M$  is not hyperbolic, then there are distinct points  $p, q \in M$  such that  $k_M(p, q) = 0$ . We use Lemma 2, in which we take  $r = 1/2$  and  $\delta = 1/\nu$ ; by this lemma for any natural number  $\nu$  there is a mapping  $f^\nu \in \mathcal{O}(U, M)$  such that  $f^\nu(0) \in B_{1/2}$  but  $f^\nu(U_{1/\nu}) \not\subset B$ . It is obviously impossible to extract from the sequence  $\{f^\nu\}$  a subsequence that is either uniformly convergent on compact subsets of  $U$ , or compactly divergent. Thus,  $M$  does not possess the Montel property. ▶

The converse is not true. This follows from another theorem, and in order to state it we need a definition.

**DEFINITION.** Let  $\bar{U} = \{|\zeta| \leq 1\}$  be the closed disc and let  $A_r = \{r \leq |z| \leq 1\}$  be an annulus in it. We consider an arbitrary sequence  $\{f^\nu\}$  of holomorphic mappings of  $\bar{U}$  into a complex manifold  $M$  and we denote by  $f^\nu|_{A_r}$  the restriction of  $f^\nu$  to the annulus  $A_r$  for some  $r < 1$ . We will say that  $M$  satisfies the *disc condition* if the fact that  $f^\nu|_{A_r}$  converges uniformly in  $A_r$  to a mapping  $f \in \mathcal{O}(A_r, M)$  implies that  $f^\nu$  converges uniformly in  $\bar{U}$  to some mapping  $\tilde{f} \in \mathcal{O}(\bar{U}, M)$ .

The disc condition is one of the forms of complex convexity; it implies the pseudoconvexity of manifolds (this is a generalization of the continuity principle from subsection 36).

**THEOREM 4.** *If a complex manifold  $M$  possesses the Montel property, then it satisfies the disc condition.*

◀ We take the unit disc  $\bar{U}$ , an annulus  $A_r$  in it, and an arbitrary sequence  $f^\nu \in \mathcal{O}(\bar{U}, M)$  such that the restriction  $f^\nu|_{A_r} \rightarrow f \in \mathcal{O}(A_r, M)$ . Since  $\bigcup_{\nu=1}^\infty f^\nu(A_r)$  is a compact subset of  $M$ , then it is not possible to extract a compactly divergent sequence from the sequence  $\{f^\nu|_{A_r}\}$ . But then by the Montel property we can extract from it a subsequence that converges uniformly on  $\bar{U}$  to a mapping  $\tilde{f} \in \mathcal{O}(\bar{U}, M)$ . Since  $\tilde{f}|_{A_r} = f$  (since on  $A_r$  the whole sequence converges to  $f$ ), then by the uniqueness theorem  $\tilde{f}$  does not depend on the choice of subsequence. But it follows from this that the whole sequence  $f^\nu \rightarrow \tilde{f}$  converges in  $\bar{U}$ , and the disc condition holds. ▶

**EXAMPLE.** A bounded domain in  $\mathbb{C}^n$  that is not a domain of holomorphy is a hyperbolic manifold, but the disc condition does not hold, and hence, it also does not possess the Montel property, and a converse theorem to Theorem 3 does not hold.

We say that a hyperbolic manifold  $M$  is *complete hyperbolic* if any set on it that is bounded in the Kobayashi metric  $k_M$  is compact. For such manifolds a converse theorem to Theorem 3 does indeed hold.

**THEOREM 5.** *A complete hyperbolic manifold  $M$  possesses the Montel property.*

◀ Since  $M$  is hyperbolic, then by Theorem 2 the family  $\mathcal{O}(U, M)$  is equicontinuous in the metric  $k_M$ . Suppose that it is not possible to isolate a compactly divergent sequence from the sequence  $f^\nu \in \mathcal{O}(U, M)$ . Then there are sets  $K_0 \subset\subset U$ ,  $K'_0 \subset\subset M$  and a subsequence of  $\{f^\nu\}$  (which we again denote by  $\{f^\nu\}$ ) such that  $f^\nu(K_0) \cap K'_0 \neq \emptyset$  for all  $\nu$ . Therefore there is a sequence  $\zeta_\nu \in K_0$  such that  $f^\nu(\zeta_\nu) \in K'_0$  for all  $\nu$ .

Let  $K$  be an arbitrary compact subset of  $U$ ; we shall prove that there exists a bounded set  $K'$  in the Kobayashi metric that contains all the  $f^\nu(K)$ . Without loss of generality we may assume that  $K \supset K_0$ ; by the contractibility property there is a number  $R_1$  such that  $k_M(f^\nu(\zeta), f^\nu(\zeta_0)) \leq R_1$  for all  $\zeta \in K$ ,  $\zeta_0 \in K_0$ , and all  $\nu$ . On the other hand, for any fixed point  $p \in M$  there exists a number  $R_2$  such that  $k_M(p, p_0) \leq R_2$  for all  $p_0 \in K'_0$ . Then

$$k_M(f^\nu(\zeta), p) \leq k_M(f^\nu(\zeta), f^\nu(\zeta_\nu)) + k_M(f^\nu(\zeta_\nu), p) \leq R_1 + R_2$$

for all  $\zeta \in K$  and all  $\nu$ . Thus, we can take as  $K'$  the Kobayashi ball with center  $p$  and radius  $R_1 + R_2$ .

We have proved that the sequence  $\{f^\nu\}$  is not only equicontinuous, but also uniformly bounded in the metric  $k_M$ . Since by hypothesis any bounded set in this metric is compact, then, exactly as in the proof of Montel's theorem in subsection 39 of Part I, we will conclude from this that we can extract from  $\{f^\nu\}$  a subsequence that converges uniformly on compact subsets of  $U$ . We have proved that the family  $\mathcal{O}(U, M)$  is normal, i.e., possesses the Montel property. ▶

Combining Theorems 4 and 5 we obtain

**THEOREM 6.** *Any complete hyperbolic manifold satisfies the disc condition.*

In particular, any domain in  $\mathbb{C}^n$  which is a complete hyperbolic manifold is also a domain of holomorphy.

\* We say that in a domain  $D \subset \mathbb{C}^n$  the Carathéodory metric is *complete* if any bounded (in this metric) subset in  $D$  is compact. Suppose  $D$  is of this type; prove that (a)  $D$  is a domain of holomorphy, and (b) any holomorphic mapping  $f: U \setminus \{0\} \rightarrow D$  extends to a holomorphic mapping  $U \rightarrow D$ . \*

In conclusion we give a condition for the hyperbolicity of a manifold, expressed in terms of curvature. In order to state it we need several definitions. A complex manifold  $M$  is said to be *Hermitian* if in the fibers of its tangent bundle  $T(M) = \bigcup_{p \in M} T_p(M)$  a positive Hermitian form is given which is locally represented in the form

$$h_p(u, v) = \sum_{j, k} h_{jk}(p) dz_j(u) \overline{dz_k(v)}, \quad h_{jk} = \overline{h_{kj}}, \quad (7)$$

where for arbitrary smooth vector fields  $u(p)$  and  $v(p)$  on  $M$  the quantity  $h_p(u, v)$  depends smoothly on  $p$ . If the differential form

$$\omega = \frac{i}{2} \sum_{j,k} h_{jk}(p) dz_j \wedge d\bar{z}_k \tag{8}$$

corresponding to (7) is closed ( $d\omega = 0$ ), then the manifold  $M$  is said to be *Kaehler*. The metrics defined by the forms (7) and (8) are given the same names.

EXAMPLES. The Bergman metric in domains of  $\mathbb{C}^n$  of bounded type is Kaehler, since the Hermitian form

$$ds^2 = \sum \frac{\partial^2 \ln K}{\partial z_j \partial \bar{z}_k} dz_j d\bar{z}_k$$

is positive definite, and the corresponding differential form  $\omega = dd^c \ln K$  is closed. The Fubini-Study metric is also Kaehler; this is the standard metric of complex projective space  $\mathbb{P}^n$ , defined by the form  $\omega = dd^c \ln |w|^2$ , where  $w = (w_0, \dots, w_n)$  are homogeneous coordinates (see subsection 19).

The distance between points of a Hermitian manifold  $M$  is introduced in the usual way. The length of a piecewise-smooth path  $\gamma: I \rightarrow M$ , where  $I$  is the interval  $[0, 1]$ , is defined by the formula

$$|\gamma| = \int_0^1 \sqrt{h_{\gamma(t)}(\gamma'_t, \gamma'_t)} dt, \tag{9}$$

and the distance  $d(p, q)$  is defined as the infimum of the lengths of the piecewise smooth paths on  $M$  that join the points  $p$  and  $q$ . Since  $h(\gamma', \gamma') = g(\gamma', \gamma')$ , where  $g = \text{Re } h$ , then this distance coincides with the Riemannian distance defined by the metric  $g$ .

Suppose we are given a Hermitian manifold  $M$  and a holomorphic curve  $\gamma: U \rightarrow M$ , where  $U = \{|\zeta| < R\}$  is a disc on the complex plane. Let  $\zeta_0 \in U$  be a noncritical point of  $\gamma$  and let  $z = z(p)$  be local coordinates on  $M$  in a neighborhood of the point  $p_0 = \gamma(\zeta_0)$ ; then the metric (7) induces the Hermitian metric

$$h_p|_\gamma = \sum_{j,k} h_{jk} \circ \gamma(\zeta) \cdot \gamma'_j(\zeta) \overline{\gamma'_k(\zeta)} d\zeta d\bar{\zeta} = H_\gamma(\zeta) d\zeta d\bar{\zeta} \tag{10}$$

on  $\gamma(U)$  in a neighborhood of  $p_0$ , where  $H_\gamma(\zeta_0) > 0$ . Considering  $\gamma(U)$  as a real two-dimensional surface, we can compute its Gaussian curvature at the point  $p_0$  by the formula<sup>(8)</sup>

$$K_\gamma(p_0) = - \frac{2}{H_\gamma(\zeta_0)} \frac{\partial^2 \ln H_\gamma}{\partial \zeta \partial \bar{\zeta}} \Big|_{\zeta_0}. \tag{11}$$

Under a conformal change of the parameter  $\zeta = \zeta(\omega)$  on the curve  $\gamma$  the quantity  $H_\gamma$  is multiplied by  $|\zeta'(\omega)|^2$ ; this same factor also appears in the

<sup>(8)</sup>Obviously, the coordinates  $\xi = \text{Re } \zeta$  and  $\eta = \text{Im } \zeta$  are isometric on  $f(U)$  in a neighborhood of the point  $p_0$ , and  $\frac{\partial^2}{\partial \xi \partial \bar{\xi}} = \frac{1}{4} \Delta$ , where  $\Delta$  is the Laplacian, so that (11) coincides with the usual formula.

recalculation of  $\partial^2 \ln H_\gamma / \partial \zeta \partial \bar{\zeta}$  to a derivative with respect to  $\omega$  and  $\bar{\omega}$ , so that  $K_\gamma(p_0)$  is invariant relative to such a change. We call this quantity the *curvature of the holomorphic curve  $\gamma$  at the point  $p_0$* .

**DEFINITION.** We shall say that the *holomorphic curvature* of a Hermitian manifold  $M$  does not exceed a constant  $k$  if, for all holomorphic curves  $\gamma: U \rightarrow M$ , at all noncritical points  $\zeta_0$  the curvature  $K_\gamma(\gamma(\zeta_0)) \leq k$ .

If  $M$  is a complex one-dimensional manifold (i.e., a holomorphic curve), then the curvature  $K_M$  depends only on the point  $p$ . In particular, for the unit disc with the Lobachevskii metric we have  $ds^2 = \frac{d\zeta d\bar{\zeta}}{(1-|\zeta|^2)^2}$ , i.e.,  $H = (1 - |\zeta|^2)^{-2}$ , and by formula (11) we conclude that  $K \equiv -4$  is constant and negative. For  $\bar{C}$  with the spherical metric we have  $H = (1 + |\zeta|^2)^{-2}$  and  $K \equiv 4$  is constant and positive.

We need a generalization of the Schwarz lemma in its invariant formulation, according to which for any holomorphic mapping  $f: U \rightarrow U$  of the unit disc

$$\frac{|df|}{1 - |f(\zeta)|^2} \leq \frac{|d\zeta|}{1 - |\zeta|^2} \tag{12}$$

(see formula (7) of subsection 57; here we give a differential variant of this lemma). If we denote by  $ds_U^2 = \frac{|d\zeta|^2}{(1-|\zeta|^2)^2}$  the Lobachevskii metric of the unit disc and  $f^*(ds_U^2) = \frac{|df|^2}{(1-|f(\zeta)|^2)^2}$  is its inverse image under the mapping  $f$  (in general,  $f^*(ds_U^2)$  is only a semimetric, since  $|df|^2 = |f'(\zeta)|^2 |d\zeta|^2$  vanishes at the critical points of  $f$ ), then (12) can be rewritten in the form  $f^*(ds_U^2) \leq ds_U^2$ . The generalization that we have in mind was obtained by L. AHLFORS.

**LEMMA (Ahlfors).** Let  $M$  be a Hermitian manifold with metric  $ds_M^2$ , whose holomorphic curvature is bounded above by a negative constant  $-k$ . Then for any holomorphic mapping  $f: U \rightarrow M$  at any point  $\zeta \in U$  we have

$$f^*(ds_M^2) \leq \frac{4}{k} ds_U^2, \tag{13}$$

where  $f^*(ds_M^2)$  is the inverse image of  $ds_M^2$  under the mapping  $f$ , and  $ds_U^2$  is the Lobachevskii metric of the unit disc.<sup>(9)</sup>

◀ The forms in (13) are proportional:  $f^*(ds_M^2) = u(\zeta) ds_U^2$ , where  $u \geq 0$  is a smooth function in  $U$ , and we need to prove that  $u(\zeta) \leq 4/k$  at any point  $\zeta \in U$ . We fix  $\zeta_0 \in U$ , an arbitrary number  $r$ ,  $|\zeta_0| < r < 1$ , and we set  $ds_r^2 = r^2 |d\zeta|^2 / (r^2 - |\zeta|^2)^2$ ,  $u_r = f^*(ds_M^2) / ds_r^2$ . Since  $u_r(\zeta_0) \rightarrow u(\zeta_0)$  as  $r \rightarrow 1$ , it suffices for us to prove that  $u_r(\zeta_0) \leq 4/k$ .

<sup>(9)</sup>If  $M = U$  and  $ds_U^2$  is the Lobachevskii metric, then we can take  $k = 4$  and (13) is the same as (12)—Ahlfors's lemma indeed generalizes the Schwarz lemma in the invariant formulation.



If we set  $f^*(ds_M^2) = H|d\zeta|^2$ , then the function  $H$  will be bounded in the disc  $\bar{U}_r = \{|\zeta| \leq r\}$ , and  $H_r = r^2/(r^2 - |\zeta|^2)^2 \rightarrow \infty$  as  $|\zeta| \rightarrow r$ , so that  $u_r = H/H_r \rightarrow 0$  as  $|\zeta| \rightarrow r$ , and hence, attains its maximum inside of  $U_r$ . It suffices to prove the desired inequality for a maximum point; therefore we may assume that  $\zeta_0$  is a maximum point.

If  $u_r(\zeta_0) = 0$ , then the inequality is trivial, and if  $u_r(\zeta_0) > 0$ , then  $\zeta_0$  is not a critical point of the curve  $f$ , and since we have  $f^*(ds_M^2) = H|d\zeta|^2$ , then by formula (11) the curvature of the curve  $f$  at the point  $p_0 = f(\zeta_0)$  is given by

$$K_f(p_0) = -\frac{2}{H(\zeta_0)} \frac{\partial^2 \ln H}{\partial \zeta \partial \bar{\zeta}} \Big|_{\zeta_0} \leq -k$$

(we have used the hypothesis of the lemma). On the other hand, since the curvature of the Lobachevskii metric in the disc  $U_r$  is equal to  $-4$ , then

$$\frac{2}{H_r(\zeta_0)} \frac{\partial^2 \ln H_r}{\partial \zeta \partial \bar{\zeta}} \Big|_{\zeta_0} = 4,$$

and hence,

$$\frac{\partial^2 \ln u_r}{\partial \zeta \partial \bar{\zeta}} \Big|_{\zeta_0} = \frac{\partial^2 \ln H}{\partial \zeta \partial \bar{\zeta}} \Big|_{\zeta_0} - \frac{\partial^2 \ln H_r}{\partial \zeta \partial \bar{\zeta}} \Big|_{\zeta_0} \geq \frac{kH(\zeta_0)}{2} - 2H_r(\zeta_0).$$

But, as we know from analysis, at a maximum point of a function of two real variables its Laplacian is nonpositive, so that the left-hand side of the last inequality is  $\leq 0$  and  $kH(\zeta_0) - 4H_r(\zeta_0) \leq 0$ , and since we have  $H(\zeta_0) > 0$ , then  $u_r(\zeta_0) = H(\zeta_0)/H_r(\zeta_0) \leq 4/k$ . ►

Our goal is close at hand. The condition for the hyperbolicity of a manifold in terms of curvature is now obtained quite simply.

**THEOREM 7.** *A Hermitian manifold  $M$  whose holomorphic curvature does not exceed a negative constant  $-k$  is hyperbolic.*

◀ From formulas (10) and (11) we see that, multiplying the metric  $ds_M^2$  by a suitable positive constant, we may assume  $k = 4$ . By Ahlfors's lemma then for any holomorphic mapping  $f$  of the unit disc  $U$  into  $M$  we have  $f^*(ds_M^2) \leq ds_U^2$ , where  $ds_U^2$  is the Lobachevskii metric. If  $d$  is the distance on  $M$  in the metric  $ds_M^2$  and  $\rho$  is Lobachevskii distance, then we have as a consequence that  $d(f(a), f(b)) \leq \rho(a, b)$  for arbitrary points  $a, b \in U$ . Thus, the metric  $d$  does not increase distances for holomorphic mappings  $U \rightarrow M$ , and by Theorem 3 of subsection 58 the Kobayashi distance  $k_M(p, q) \geq d(p, q)$  for any  $p, q \in M$ . Since  $d$  is a metric, then  $d(p, q)$ , and hence,  $k_M(p, q)$  is nonzero for  $p \neq q$ . ►

**60. Generalizations of Picard's theorem.** The definition of hyperbolicity immediately implies

**THEOREM 1.** *If  $N$  is a manifold with trivial Kobayashi metric and  $M$  is a hyperbolic manifold, then any holomorphic mapping  $f: N \rightarrow M$  is constant.*

◀ Let  $p, q$  be arbitrary points of  $N$ ; we have  $k_N(p, q) = 0$ , and since  $f$  does not increase distances, then  $k_M(f(p), f(q)) = 0$ . Since  $M$  is hyperbolic we conclude that  $f(p) = f(q)$ . ▶

In particular, any holomorphic mapping  $f: \mathbb{C}^m \rightarrow M$  is constant if  $M$  is hyperbolic. For  $m = 1$  this assertion is expressed in words: a hyperbolic manifold does not contain entire curves. The converse is false.

**EXAMPLE.** We consider the manifold

$$M = \{(z_1, z_2) \in \mathbb{C}^2: |z_1| < 1, |z_1 z_2| < 1\} \setminus \{(0, z_2): |z_2| \geq 1\}; \quad (1)$$

the mapping  $h: (z_1, z_2) \rightarrow (z_1, z_1 z_2)$  transforms  $M$  to the bidisc  $\{|w_1| < 1, |w_2| < 1\}$  and is one-to-one everywhere except for  $\{z_1 = 0\}$ . For any holomorphic mapping  $f: \mathbb{C} \rightarrow M$  the mapping  $h \circ f = \text{const}$  by Liouville's theorem (subsection 5), and hence, either  $f = \text{const}$  or  $f: \mathbb{C} \rightarrow M \cap \{z_1 = 0\}$ . But the last set is the disc  $\{z_2 \in \mathbb{C}: |z_2| < 1\}$ , so that again  $f = \text{const}$ . Thus,  $M$  does not contain entire curves.

But  $M$  is not a hyperbolic manifold. In fact, let  $p = (0, b) \in M$ ,  $b \neq 0$ , and  $p_\nu = (1/\nu, b) \in M$ ,  $\nu = 1, 2, \dots$ ; we have  $k_M(0, p) = \lim_{\nu \rightarrow \infty} k_M(0, p_\nu)$ . The mapping

$$f: \zeta \rightarrow (a_\nu \zeta / \nu, a_\nu b \zeta),$$

where  $|a_\nu| = \min(\nu, \sqrt{\nu/|b|})$ , maps the unit disc  $U = \{|\zeta| < 1\}$  into  $M$ , and  $f(1/a_\nu) = p_\nu$ . Therefore by the definition of the Kobayashi metric

$$k_M(0, p_\nu) \leq \rho \left( 0, \frac{1}{a_\nu} \right) = \ln \frac{|a_\nu| + 1}{|a_\nu| - 1} \rightarrow 0 \quad \text{as } \nu \rightarrow \infty$$

and hence,  $k_M(0, p) = 0$ .

Theorem 1 can be considered as the simplest generalization of the little Picard theorem, which asserts that any holomorphic mapping  $\mathbb{C}$  into  $\mathbb{C}$  with two omitted points is constant (see subsection 44 of Part I). Indeed, as we have seen,  $\mathbb{C}$  minus two points, or, equivalently,  $\overline{\mathbb{C}}$  minus three points, is a hyperbolic manifold.

We proceed to other generalizations. Fatou's example (subsection 11) shows that for  $n > 1$  one should not expect degeneration of a holomorphic mapping into  $\mathbb{C}^n$  minus an arbitrary number of points. However, for  $n = 1$  the points  $\{z = a\}$  can also be considered as sets of complex codimension 1, complex "hyperplanes". Since  $\overline{\mathbb{C}}$  can be identified with the complex projective line  $\mathbb{P}$ , then the little Picard theorem admits the following treatment: any holomorphic mapping of  $\mathbb{C}$  into  $\mathbb{P}$  minus three "hyperplanes" is constant. In this treatment the theorem admits a direct generalization to the higher-dimensional case:

**THEOREM 2.** *Any holomorphic mapping  $f: \mathbb{C}^m \rightarrow \mathbb{P}^n \setminus \{2n + 1 \text{ hyperplanes in general position}\}$  is constant.*

Theorem 2 was obtained by M. GREEN as a corollary of another interesting theorem, the idea of whose proof we now describe.<sup>(10)</sup> First of all we note a generalization of the classical LEMMA OF BOREL: *if the entire functions  $g_j: \mathbb{C}^m \rightarrow \mathbb{C}$  ( $j = 0, \dots, n$ ) identically satisfy the relation*

$$e^{g_0(z)} + \dots + e^{g_n(z)} \equiv 0, \tag{2}$$

*then at least one of the differences  $g_j - g_k$  ( $j \neq k$ ) is constant.*

This generalization reduces to the classical case  $m = 1$  (see problem 20 to Chapter IV of Part I) by considering the restrictions of the  $g_j$  to complex lines passing through the origin  $0 \in \mathbb{C}^m$ : for each such line  $l$  there is a pair of numbers  $(j, k)$ ,  $j \neq k$ , such that  $(g_j - g_k)|_l$  is equal to a constant that does not depend on  $l$  (equal to  $g_j(0) - g_k(0)$ ). Since there are infinitely many such lines  $l$  and there are a finite number of pairs  $(j, k)$ , then there is a pair  $(j, k)$  such that  $(g_j - g_k)|_l = \text{const}$  for an infinite set of lines  $l$ , and from this by the uniqueness theorem we can conclude that  $g_j - g_k = \text{const}$ .

LEMMA. *For a holomorphic mapping  $f: \mathbb{C}^m \rightarrow \mathbb{P}^n \setminus \{n + 2 \text{ distinct hyperplanes}\}$  the image  $f(\mathbb{C}^m)$  lies in a proper linear subspace of  $\mathbb{P}^n$ .*

◀ We write the excluded planes by the homogeneous equations  $\sum_{k=0}^n a_{jk} z_k = 0$  ( $j = 1, \dots, n + 2$ ) and also represent the mapping  $f$  in homogeneous coordinates:  $f = (f_0, \dots, f_n)$ . We have  $n + 2$  nonvanishing entire functions  $\sum_{k=0}^n a_{jk} f_k$ , which can therefore be written in the form

$$\sum_{k=0}^n a_{jk} f_k = e^{g_j}, \quad j = 1, \dots, n + 2, \tag{3}$$

where  $g_j: \mathbb{C}^m \rightarrow \mathbb{C}$  are entire functions. The vectors  $a^j = (a_{j0}, \dots, a_{jn}) \in \mathbb{C}^{n+1}$  are linearly dependent, since there are  $n + 2$  of them; therefore there are  $\lambda_j$ , not all equal to zero and such that  $\sum_{j=1}^{n+2} \lambda_j a_{jk} = 0$  ( $k = 0, \dots, n$ ). Multiplying these relations by  $f_k$  and summing over  $k$ , taking (3) into account we obtain  $\sum_{j=1}^{n+2} \lambda_j e^{g_j} = 0$ . We let  $J = \{j: \lambda_j \neq 0\}$ ; this set is nonempty and the last identity can be rewritten in the form  $\sum_{j \in J} e^{g_j + \ln \lambda_j} \equiv 0$ . By Borel's lemma there are  $j_1, j_2 \in J$ ,  $j_1 \neq j_2$ , such that  $g_{j_1} - g_{j_2} = c = \text{const}$ , and, hence,  $e^{g_{j_1}} = e^c e^{g_{j_2}}$ . We then obtain from (3) that

$$\sum_{k=0}^n (a_{j_1 k} - e^c a_{j_2 k}) f_k \equiv 0, \tag{4}$$

and the brackets are not all equal to zero, since the excluded planes are distinct. We have obtained a nontrivial linear relation between the  $f_k$ . ▶

<sup>(10)</sup>Theorem 2 also follows from Theorem 1 on the basis of Kiernan's result cited in footnote 7 in subsection 59: the manifold  $\mathbb{P}^n \setminus \{2n + 1 \text{ hyperplanes in general position}\}$  is hyperbolic. Moreover, the essence of this theorem is already contained in a paper of BOREL dating from 1898.

**THEOREM 3 (M. Green).** *For a holomorphic mapping  $f: \mathbb{C}^m \rightarrow \mathbb{P}^n \setminus \{n+k \text{ hyperplanes in general position}\}$  the image  $f(\mathbb{C}^m)$  lies in a linear subspace of  $\mathbb{P}^n$  of dimension equal to the integer part of  $n/k$ .*

◀ We illustrate the idea of the proof in the special case  $n = 3$ . Here the theorem reduces to two assertions:

(a) If  $k = 2$ , i.e.,  $f$  omits five hyperplanes  $H_1, \dots, H_5$  in general position, then  $f(\mathbb{C}^m)$  belongs to a complex line (the integer part  $E(3/2) = 1$ ).

(b) If  $k = 4$ , i.e.,  $f$  omits seven hyperplanes  $H_1, \dots, H_7$  in general position, then  $f = \text{const}$  ( $E(3/4) = 0$ ).<sup>(11)</sup>

**PROOF OF (a).** From the lemma (for  $n = 3$ ) it follows that  $f(\mathbb{C}^m)$  lies in a plane  $\Pi$  of complex dimension 2 (a hyperplane in  $\mathbb{P}^3$ ). We shall show that the omitted planes intersect  $\Pi$  in at most four complex lines. Since the  $H_j$  are in general position, then no three of them can intersect in a line and no four can intersect in a point. There can only be three lines of intersection of  $H_j$  with  $\Pi$  in the case when  $\Pi$  contains lines of the intersection of two pairs of the  $H_j$  (Figure 51). Let one of the pairs be  $H_1, H_2$  and the line  $l_1 = H_1 \cap H_2$ . In the second pair neither  $H_1$  nor  $H_2$  can occur, since then the common plane of two pairs would coincide with  $\Pi$ , and this is impossible, since  $\Pi$  contains  $f(\mathbb{C}^m)$ . Suppose that  $H_3, H_4$  is the second pair and  $H_3 \cap H_4 = l_2$ ; then the lines  $l_1$  and  $l_2$  have a common point (since they both lie in the projective plane  $\Pi$ ), which is impossible, since four  $H_j$  would intersect at this point.

Thus,  $f$  maps  $\mathbb{C}^m$  into the two-dimensional projective plane  $\Pi = \mathbb{P}^2$  with four distinct complex lines omitted. By the same lemma (for  $n = 2$ ) we conclude that  $f(\mathbb{C}^m)$  lies on a complex projective line.

**PROOF OF (b).** By assertion (a),  $f(\mathbb{C}^m)$  belongs to a complex projective line  $L$ . This line intersects the omitted hyperplanes  $H_j$  in at most three points. In fact, the least number of intersections will occur when  $L$  passes through the points of intersection of two triples of the  $H_j$ ; let  $a = H_1 \cap H_2 \cap H_3$  and  $b = H_4 \cap H_5 \cap H_6$  (one plane cannot be included in different triples). The

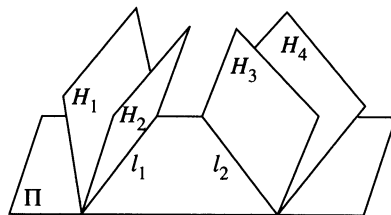

FIGURE 51

<sup>(11)</sup>In the case  $k = 1$  the assertion is trivial, since  $E(n/k) = n$ ; the case  $k = 3$  is weaker than (a), since here again  $E(3/3) = 1$ , and the case  $k > 4$  is weaker than (b), since here  $E(3/k) = 0$ .

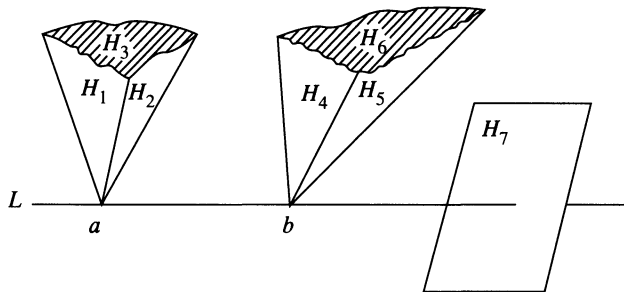

FIGURE 52

plane  $H_7$  still remains, and by the general position hypothesis it intersects  $L$  in points different from  $a$  and  $b$  (Figure 52).

Now we can apply Picard’s theorem for functions of one variable to the restriction of  $f$  to any complex line  $l \subset \mathbb{C}^m$ :  $f|_l$  maps  $l$  into the line  $L$  minus three points, and, hence, is constant. But then  $f = \text{const}$  as well. ►

In the case of arbitrary  $n$  the proof is based on the same ideas, but requires additional arguments of a combinatorial nature.<sup>(12)</sup> Theorem 2 is a special case of Theorem 3: if the number of omitted hyperplanes is equal to  $2n + 1$ , then  $k = n + 1$ ,  $E(n/k) = 0$ , and hence,  $f = \text{const}$ .

We pass to a generalization of the big Picard theorem, which for functions of one variable can be stated as follows: any holomorphic mapping of the punctured disc  $U_* = \{0 < |\zeta| < 1\}$  into the closed plane  $\mathbb{P}$  with three points omitted extends to a holomorphic mapping of the disc  $U$  into  $\mathbb{P}$ .<sup>(13)</sup> In contrast to the little Picard theorem the big theorem does not extend to arbitrary hyperbolic manifolds.

EXAMPLE. The manifold

$$M = \{[z_0, z_1, z_2] \in \mathbb{P}^2 : z_0 = 1, 0 < |z_1| < 1, |z_2| < |e^{1/z_1}|\}$$

is hyperbolic, since the mapping  $(1, z_1, z_2) \rightarrow (z_1, z_2 e^{-1/z_1})$  transforms it biholomorphically into the hyperbolic manifold  $U_* \times U$ . However the mapping  $f: U_* \rightarrow M$  defined by the formula  $f(\zeta) = [1, \zeta, \frac{1}{2}e^{1/\zeta}]$  cannot be extended holomorphically to  $U$ .

However, the following result does hold.

**THEOREM 4 (Mrs. Kwack).** *If  $M$  is a hyperbolic manifold, then the holomorphic mapping  $f: U_* \rightarrow M$  either extends holomorphically to  $U$  or its limit set at the point  $\zeta = 0$  does not contain points of  $M$ .*

◀ Suppose the limit set of  $f$  at the point  $\zeta = 0$  contains a point  $p_0 \in M$ , i.e., there exists a sequence  $\zeta_\nu \rightarrow 0$  of points of  $U_*$  for which  $f(\zeta_\nu) \rightarrow p_0$ .

<sup>(12)</sup>See M. Green, *Holomorphic maps into complex projective space omitting hyperplanes*, Trans. Amer. Math. Soc. **169** (1972), 89–103.

<sup>(13)</sup>This formulation is equivalent to the one given in subsection 44 of Part I, since  $f$  extends in  $U$  to a holomorphic mapping into  $\mathbb{P}$ , then  $\zeta = 0$  is a removable singular point or a pole, and cannot be an essential singularity of  $f$ .

Let  $V$  denote a neighborhood of  $p_0$  which in local coordinates on  $M$  with center  $p_0$  is described as  $\{p \in M : |z(p)| < \varepsilon\}$  and  $W = \{p \in M : |z(p)| < \varepsilon/2\}$ ; let  $r_\nu = |\zeta_\nu|$  and  $\gamma_\nu = \{|\zeta| = r_\nu\}$ . Since the Kobayashi diameter  $f(\gamma_\nu) \rightarrow 0$  (in view of the example at the beginning of subsection 59 and the contractibility property), then  $f(\gamma_\nu) \subset W$  for  $\nu \geq \nu_0$ , and without loss of generality we may assume that  $\nu_0 = 1$  and that  $r_\nu$  decreases to zero.

It suffices to prove the continuous extendability of  $f$  at the point  $\zeta = 0$ , i.e., that the image of  $\{0 < |\zeta| < \delta\}$  for sufficiently small  $\delta$  belongs to  $W$ . If only a finite number of images of the annuli  $\{r_{\nu+1} < |\zeta| < r_\nu\}$  extend beyond the limits of  $W$ , then everything is proved; in the case when there are infinitely many such annuli we will arrive at a contradiction. Passing to a subsequence, we may assume that the images of all the annuli extend beyond the limits of  $W$ .

We denote by  $A_\nu = \{\alpha_\nu < |\zeta| < \beta_\nu\}$  the largest of the annuli for which  $\alpha_\nu < r_\nu < \beta_\nu$  and  $f(A_\nu) \subset W$ , and by  $\gamma'_\nu = \{|\zeta| = \beta_\nu\}$ ,  $\gamma''_\nu = \{|\zeta| = \alpha_\nu\}$  the boundary circles of  $A_\nu$  (their images are contained in  $\overline{W}$ , but not in  $W$ ). Since the diameters of  $f(\gamma'_\nu)$  and  $f(\gamma''_\nu)$  tend to zero (see Example 1 at the beginning of subsection 59), then, passing to a subsequence if necessary, we may assume that  $f(\gamma'_\nu) \rightarrow p'$ ,  $f(\gamma''_\nu) \rightarrow p''$ . The points  $p'$ ,  $p'' \in \partial W$ , and hence, are different from  $p_0$ ; without loss of generality, we assume that  $z_1(p')$  and  $z_1(p'')$  are different from  $z_1(p_0) = 0$  ( $z_1(p)$  is the first coordinate of  $z(p)$ ).

On the set  $f^{-1}(W)$  the mapping  $f$  is represented in local coordinates in the form  $(f_1, \dots, f_n)$  and, in particular, for all  $\nu$  a holomorphic mapping  $f_1: A_\nu \rightarrow \mathbb{C}$  is defined. For sufficiently large  $\nu$  the image  $f_1(\gamma_\nu)$  lies in a neighborhood of the point  $z_1 = 0$ , not intersecting neighborhoods of the points  $z_1(p')$  and  $z_1(p'')$ , which contain  $f_1(\gamma'_\nu)$  and  $f_1(\gamma''_\nu)$ . The union of the latter forms  $f_1(\partial A_\nu)$ , and by the domain preservation principle from subsection 35 of Part I the mapping  $f_1$  cannot take interior points of  $A_\nu$  to  $\partial f_1(A_\nu)$ , i.e.,  $\partial f_1(A_\nu) \subset f_1(\partial A_\nu)$ . On the other hand,  $f_1(A_\nu)$  is a bounded domain containing  $f_1(\gamma_\nu)$ , and under our hypotheses there does not exist a bounded domain whose boundary belongs to the union  $f_1(\gamma'_\nu) \cup f_1(\gamma''_\nu)$  and which contains  $f_1(\gamma_\nu)$ . Contradiction. ►

In particular, for  $M = \mathbb{P} \setminus \{\text{three points}\}$  we obtain from Theorem 4 the big Picard theorem for functions of one variable. Indeed, in this case the limit set, since it is connected, must reduce to one of the excluded points, and then  $f$  extends continuously to the point  $\zeta = 0$ .

If  $M$  is a compact hyperbolic manifold, then any holomorphic mapping  $f: U_* \rightarrow M$  extends to a mapping from  $\mathcal{O}(U, M)$ , since here the second possibility of Theorem 4 cannot be realized.

In conclusion we shall describe methods recently proposed by P. GRIFFITHS and based on the concept of Ricci curvature. In order to define this concept, we call a *Euclidean volume form* of an  $n$ -dimensional complex manifold  $M$

a form of bidegree  $(n, n)$ , which in local coordinates  $z = (z_1, \dots, z_n)$  has the form

$$\Phi = \prod_{k=1}^n \frac{i}{2} dz_k \wedge d\bar{z}_k \tag{5}$$

(the product is the exterior product, and the factor  $\frac{i}{2}$  is introduced so that the form will be real). As is known, all the forms of maximal degree on a manifold are proportional (see subsection 14), and those  $(n, n)$ -forms on  $M$  which differ from  $\Phi$  by a positive factor, i.e., the forms

$$\Omega = \lambda\Phi, \quad \lambda > 0, \tag{6}$$

are termed "positive". Every smooth positive form  $\Omega$  is called a *volume form* of the manifold  $M$ , and the form

$$\text{Ric } \Omega = dd^c \ln \lambda \tag{7}$$

of bidegree  $(1,1)$  is its *Ricci form*.

Since under a holomorphic change of coordinates the form  $\Phi$ , and hence the coefficient  $\lambda$ , is multiplied by the square of the modulus of a holomorphic function  $J \neq 0$  (the Jacobian of the change), and  $dd^c \ln|J|^2 = 0$ , the Ricci form is defined globally on  $M$  and does not depend on a choice of local coordinates. We say that a manifold  $M$  with volume form  $\Omega$  has *negative Ricci curvature* if  $\text{Ric } \Omega$  corresponds to a POSITIVE definite Hermitian form.

EXAMPLES.

1. For a complex one-dimensional Hermitian manifold with metric  $ds^2 = Hdzd\bar{z}$   $\Omega = \frac{i}{2}Hdz \wedge d\bar{z}$  will be a volume form and  $\Phi = \frac{i}{2}dz \wedge d\bar{z}$ . Therefore in this case  $\lambda = H$  and  $\text{Ric } \Omega = \frac{i}{2} \frac{\partial^2 \ln H}{\partial z \partial \bar{z}} dz \wedge d\bar{z}$ . The corresponding Hermitian form is positive if and only if the Gaussian curvature of the metric  $ds^2$  is negative (see formula (11) of subsection 59); this justifies the last definition.

2. The Lobachevskii metric in the polydisc  $\{\|z\| < R\}$  in  $\mathbb{C}^n$  is defined by the Hermitian form  $ds^2 = \sum_{k=1}^n R^2 |dz_k|^2 / (R^2 - |z_k|^2)^2$  (up to a factor it is equal to the Bergman metric; see subsection 56). The corresponding volume form

$$\Omega = \prod_{k=1}^n \frac{iR^2 dz_k \wedge d\bar{z}_k}{2(R^2 - |z_k|^2)^2} = \frac{\omega^n}{n!},$$

where  $\omega$  is the differential form corresponding to  $ds^2$ , and an elementary computation shows that the Ricci form

$$\text{Ric } \Omega = 2\omega. \tag{8}$$

The Ricci curvature of this metric is therefore negative.

In the punctured disc  $U_* = \{0 < |z| < 1\}$  the Kobayashi metric  $ds^2 = \frac{|dz|^2}{|z|^2 \ln^2(1/|z|)}$  (see formula (4) of subsection 59), and for the corresponding form  $\omega$  we also have  $\text{Ric } \Omega = 2\omega$ . Thus, in the same metric for the partially punctured polydisc  $U_*^m \times U^{n-m}$  the volume form

$$\Omega = \prod_{k=1}^m \frac{idz_k \wedge d\bar{z}_k}{2|z_k|^2 \ln^2|z_k|^2} \wedge \prod_{k=m+1}^n \frac{idz_k \wedge d\bar{z}_k}{2(1 - |z_k|^2)^2} \tag{9}$$

and for it  $\text{Ric } \Omega = 2\omega$  as before.

3. We compute the volume form of the Fubini-Study metric in  $\mathbb{P}^n$ . In a domain  $U_0 = \{[w] \in \mathbb{P}^n : w_0 \neq 0\}$  with local coordinates  $z_j = w_j/w_0$  ( $j = 1, \dots, n$ ) the Fubini-Study form  $\omega = dd^c \ln \rho$ , where  $\rho = 1 + |z|^2$  (see subsection 19), and it can be rewritten in the form

$$\omega = \frac{1}{\rho^2} \left( \rho\varphi - \frac{i}{2} \partial \rho \wedge \bar{\partial} \rho \right),$$

where  $\varphi = dd^c |z|^2$ . It is not hard to see that  $\varphi^n = n! \Phi$ , where  $\Phi$  is the Euclidean volume form (5), and that  $(\partial \rho \wedge \bar{\partial} \rho)^k = 0$  for  $k > 1$  (all the powers are exterior powers). Therefore the volume form of the metric under consideration is

$$\Omega = \omega^n = \left( \frac{\varphi}{\rho} - \frac{i \partial \rho \wedge \bar{\partial} \rho}{2\rho^2} \right)^n = \frac{n! \Phi}{\rho^n} - \frac{n! |\zeta|^2 \Phi}{\rho^{n+1}} = \frac{n! \Phi}{\rho^{n+1}}.$$

From this we see that

$$\text{Ric } \Omega = -(n + 1)\omega. \tag{10}$$

The Ricci curvature of the Fubini-Study metric is positive.

We note that in multiplying the metric by a positive constant the form  $\omega$  is also multiplied by it, but  $\text{Ric } \omega$  does not change. Therefore if desired we may assume that in Example 2  $\text{Ric } \Omega = \omega$  or

$$(\text{Ric } \Omega)^n = \Omega. \tag{11}$$

In Example 3 we saw that for the standard metric on  $\mathbb{P}^n$  the Ricci curvature is positive, but, for purposes that will shortly become clear, we need to obtain a manifold with negative curvature. We shall now show that this can be done by excluding a finite number of algebraic hypersurfaces from  $\mathbb{P}^n$ .

By  $D_j$  we denote submanifolds of  $\mathbb{P}^n$  of codimension 1, which are given by the equations  $P_j(w) = 0$ , where  $P_j$  is a homogeneous polynomial of degree  $s_j = \deg P_j$ . We assume that the  $D_j$  intersect in general position, i.e., that in a neighborhood of each intersection point there are local coordinates in which  $\bigcup_{j=1}^k D_j$  is given locally by the equation  $z_1 \cdots z_l = 0$ ,  $l \leq k$ .

**THEOREM 5.** *If  $\sum_{j=1}^k \deg P_j \geq n + 2$  under the above conditions, then on the manifold  $M = \mathbb{P}^n \setminus \bigcup_{j=1}^k D_j$  there exists a volume form  $\Omega$  with negative Ricci curvature and such that<sup>(14)</sup>*

$$(\text{Ric } \Omega)^n \geq \Omega. \tag{12}$$

◀ We write

$$\sigma_j = c_j \frac{|P_j(w)|^2}{|w|^{2s_j}}, \quad j = 1, \dots, k, \tag{13}$$

where the  $c_j > 0$  are constants,  $|w|^2 = \sum_{k=0}^n |w_k|^2$ , and  $s_j = \deg P_j$ ; these are functions of class  $C^\infty(\mathbb{P}^n)$ , equal to zero on  $D_j$  and positive in the

---

<sup>(14)</sup>This inequality means that the difference  $(\text{Ric } \Omega)^n - \Omega$  is a nonnegative form on  $M$  (it is of maximal degree).



complement to  $D_j$ . Suppose also that  $\omega_0 = dd^c \ln|w|^2$  is the Fubini-Study form. Then

$$\Omega = \omega_0^n \prod_{j=1}^n \frac{1}{\sigma_j \ln^2 \sigma_j} \tag{14}$$

is a volume form on  $M$  and its Ricci form

$$\text{Ric } \Omega = \text{Ric } \omega_0^n - \sum_{j=1}^k dd^c \ln \sigma_j - \sum_{j=1}^k dd^c \ln \ln^2 \sigma_j. \tag{15}$$

We have  $\text{Ric } \omega_0^n = -(n+1)\omega_0$  (Example 3), and  $dd^c \ln \sigma_j = -s_j dd^c \ln|z|^2$ ; since  $dd^c \ln|P_j|^2 = 0$ , we have  $-dd^c \ln \sigma_j = s_j \omega_0$ . Further,

$$dd^c \ln \ln \sigma_j = \frac{dd^c \ln \sigma_j}{\ln \sigma_j} - \frac{i}{2} \frac{\partial \ln \sigma_j \wedge \bar{\partial} \ln \sigma_j}{(\ln \sigma_j)^2}$$

and, substituting this in (15), we find that

$$\text{Ric } \Omega = \left[ \sum_{j=1}^k s_j - (n+1) + \sum_{j=1}^k \frac{2s_j}{\ln \sigma_j} \right] \omega_0 + i \sum_{j=1}^k \frac{\partial \ln \sigma_j \wedge \bar{\partial} \ln \sigma_j}{(\ln \sigma_j)^2}. \tag{16}$$

By hypothesis  $\sum_{j=1}^k s_j - (n+1) \geq 1$ , and  $\frac{1}{\ln \sigma_j}$  can be made into a continuous function in  $\mathbb{P}^n$ , as small in modulus as desired, if we choose the  $c_j$  in (13) sufficiently small; therefore we may assume that the coefficient in the square brackets in not less than  $1/2$ . We know that the form  $\omega_0$  is positive, and the second form in (16) is nonnegative—the corresponding Hermitian form is equal to  $2 \sum_{j=1}^k |\partial \ln \sigma_j|^2 / (\ln \sigma_j)^2$ , since the  $\ln \sigma_j$  are real functions. This proves that  $\text{Ric } \Omega$  is positive.

To prove the second assertion we choose local coordinates in a neighborhood of an arbitrary intersection point of the  $D_j$ , with the origin at this point, in which  $D_j = \{\zeta_j = 0\}$ . Then  $\ln \sigma_j = a_j + \ln|\zeta_j|^2$ , where  $a_j$  is a smooth function, and

$$\begin{aligned} \partial \ln \sigma_j \wedge \bar{\partial} \ln \sigma_j &= \frac{d\zeta_j \wedge d\bar{\zeta}_j}{|\zeta_j|^2} + \frac{\partial \zeta_j \wedge \bar{\partial} a_j}{\zeta_j} + \frac{\partial a_j \wedge \bar{\partial} \zeta_j}{\bar{\zeta}_j} + \partial a_j \wedge \bar{\partial} a_j \\ &= \frac{d\zeta_j \wedge d\bar{\zeta}_j + \psi_j}{|\zeta_j|^2}, \end{aligned}$$

where  $\psi_j$  is a smooth (1,1)-form, equal to zero for  $\zeta = 0$ . Let us agree to denote by  $c$  some positive constants, not necessarily the same. Using the fact that  $\omega_0 \geq c \frac{i}{2} \sum_{j=1}^n d\zeta_j \wedge d\bar{\zeta}_j$ , we find from (16) that

$$(\text{Ric } \Omega)^n \geq c \left( \frac{i}{2} \right)^n \frac{d\zeta_1 \wedge d\bar{\zeta}_1 \wedge \dots \wedge d\zeta_n \wedge d\bar{\zeta}_n + c\Psi}{\prod_{j=1}^k |\zeta_j|^2 \ln^2 |\zeta_j|},$$

where  $\Psi$  is a form with smooth coefficients, equal to zero for  $\zeta = 0$ . From this we can conclude that  $(\text{Ric } \Omega)^n \geq c\Omega$  in a sufficiently small neighborhood of the point  $\zeta = 0$ .<sup>(15)</sup> The same inequality holds in sufficiently small neighborhoods of the points of  $\bigcup D_j$  which are not points of intersection of all the  $D_j$ , and also of the points of  $M$ . Using the compactness of  $\mathbb{P}^n$ , we can assert that  $(\text{Ric } \Omega)^n \geq c\Omega$  everywhere on  $M$ . Finally, replacing  $\Omega$  by the form  $c\Omega$ , we obtain (12). ▶

Applications of Ricci curvature methods are based on the following lemma, which is a direct generalization of Ahlfors's lemma.

LEMMA (Griffiths). *Let  $M$  be an  $n$ -dimensional complex manifold with volume form  $\Omega_M$ , whose Ricci curvature is negative and satisfies condition (12), and  $U = \{z \in \mathbb{C}^n : \|z\| < 1\}$  the polydisc. Then for any holomorphic mapping  $f: U \rightarrow M$  at any point  $z \in U$*

$$f^*(\Omega_M) \leq \Omega_U, \tag{17}$$

where  $\Omega_U$  is the volume form of the polydisc, normalized so that  $(\text{Ric } \Omega_U)^n = \Omega_U$ .

◀ The proof is analogous to the proof of Ahlfors's lemma. Setting  $f^*(\Omega_M) = u(z)\Omega_U$ , we see, as we did there (passage to a smaller polydisc), that it suffices to consider the case when  $u$  attains a maximum at an interior point  $z^0 \in U$ . At this point  $0 \geq dd^c \ln u = \text{Ric } f^*(\Omega_M) - \text{Ric } \Omega_U$ , i.e.,  $\text{Ric } \Omega_U \geq \text{Ric } f^*(\Omega_M)$ . Since both forms are nonnegative, then, raising this inequality to the  $n$ th exterior power, we obtain  $(\text{Ric } \Omega_U)^n \geq (\text{Ric } f^*(\Omega_M))^n$ , and, using the hypotheses of the lemma, according to which  $(\text{Ric } \Omega_U)^n = \Omega_U$  but  $(\text{Ric } f^*(\Omega_M))^n \geq f^*(\Omega_M)$ , we are led to the inequality  $\Omega_U \geq f^*(\Omega_M)$  at the point  $z^0$ . Thus,  $u(z^0) \leq 1$ , and since  $z^0$  is a maximum point, then  $u(z) \leq 1$  everywhere in  $U$ . ▶

We notice one of the results that can be obtained by these methods; this result is a higher-dimensional generalization of a classical theorem of E. LANSDAU.<sup>(16)</sup> We let  $U_R = \{\zeta \in \mathbb{C}^n : \|\zeta\| < R\}$  and let  $U$  be the unit polydisc. Let

$$\Omega_{U_R} = c \prod_{k=1}^n \frac{iR^2 d\zeta_k \wedge d\bar{\zeta}_k}{2(R^2 - |\zeta_k|^2)^2} \tag{18}$$

be the volume form, normalized so that  $(\text{Ric } \Omega_{U_R})^n = \Omega_{U_R}$ ; as we saw in Example 3, the constant  $c$  does not depend on  $R$ .

THEOREM 6. *Let  $M$  be an  $n$ -dimensional complex manifold with volume form  $\Omega_M$  satisfying the hypotheses of Griffiths's lemma and let  $f: U_R \rightarrow M$  be a holomorphic mapping such that  $f(0) = p$  and  $|J_f(0)| \geq 1$ , where  $J_f(0) =$*

<sup>(15)</sup>At points of  $D_j$  the inequality holds trivially, since both sides vanish.

<sup>(16)</sup>Cf., for example, I. I. Privalov, *Introduction to the theory of functions of a complex variable*, 13th ed., "Nauka", Moscow, 1984, p. 262. (Russian)

$\det(\partial f_j / \partial \zeta_k)$  is the Jacobian of  $f$ , computed in local coordinates on  $M$  in a neighborhood of  $p$ . Then the radius of the polydisc  $U_R$  is bounded from above by a quantity that does not depend on the mapping  $f$ :

$$R \leq R(p). \quad (19)$$

◀ Since

$$\Omega_M(p) = H(p) \prod_{k=1}^n \frac{i}{2} dz_k \wedge d\bar{z}_k$$

and

$$\Omega_U(0) = c \prod_{k=1}^n \frac{i}{2} d\zeta_k \wedge d\bar{\zeta}_k,$$

then

$$f^* \Omega_M(0) = H(p) \prod_{k=1}^n \frac{i}{2} df_k \wedge d\bar{f}_k = H(p) |J_f(0)|^2 \frac{\Omega_U(0)}{c} \geq \frac{H(p)}{c} \Omega_U \quad (20)$$

(we have taken into account that  $|J_f(0)| \geq 1$ ). Griffiths's lemma gives the inequality  $f^* \Omega_M(0) \leq \Omega_{U_R}(0)$ , and from (18) we see that  $\Omega_{U_R}(0) = \Omega_U(0)/R^{2n}$ . Thus, we have the inequality  $\Omega_U(0)/R^{2n} \geq H(p)/c \Omega_U(0)$ , from which the assertion follows. ▶

It is clear that if the mapping  $f: U_R \rightarrow M$  is nondegenerate, i.e., there exists a point  $\zeta^0 \in U_R$ , at which  $J_f(\zeta^0) \neq 0$ , then by a linear-fractional transformation of the variable  $\zeta$  and a linear change of the parameter  $z$  we can obtain a mapping for which  $|J_f(0)| \geq 1$ . Therefore Theorem 6 gives the following

**COROLLARY.** *If an  $n$ -dimensional complex manifold  $M$  admits a volume form that satisfies the hypothesis of Griffiths's lemma, then any holomorphic mapping  $f: \mathbb{C}^n \rightarrow M$  is degenerate.*

(In fact, if  $f$  is nondegenerate, then without loss of generality we may assume that  $|J_f(0)| \geq 1$ , and then by Theorem 6 the radius of the polydisc of holomorphy of  $f$  is finite.)

This corollary is one of the generalizations of the little Picard theorem. By Theorem 5 the hypothesis of Griffiths's lemma is satisfied by the manifold  $M = \mathbb{P}^n \setminus \bigcup_{j=1}^k D_j$ , where the manifolds  $D_j$  are the zero sets of homogeneous polynomials  $P_j$ , if the  $D_j$  intersect in general position and the sum of the degrees of the  $P_j$  is not less than  $n + 2$ . If the  $D_j$  are hyperplanes, we will obtain a special case of Green's lemma (see the lemma preceding Theorem 3, where the dimensions of  $\mathbb{C}^n$  and  $M$  do not necessarily coincide, and the hyperplanes are only distinct). But this result is more general in the sense that instead of hyperplanes we can consider algebraic varieties in it.

The result of \*Green (Theorem 2) shows that if we remove more hyperplanes from  $\mathbb{P}^n$  (namely,  $2n + 1$  in general position), then the mapping  $f$

degenerates to a constant. It would be nice to hope that the same result could be achieved by removing algebraic varieties of sufficiently high degree. However, this hope is not justified, as the following example, due to KIERMAN, shows.

**EXAMPLE 6.** In  $\mathbb{P}^{2n}$  we consider a hypersurface  $A$ , which is given in homogeneous coordinates by the equation  $z_0^p + \dots + z_{2n}^p = 0$ . For any  $p \geq n$  there exists a NONCONSTANT holomorphic mapping  $f: \mathbb{C}^n \rightarrow \mathbb{P}^{2n} \setminus A$ . This mapping is constructed as follows: we define  $A$  by the affine equation  $1 + \zeta_1^p + \dots + \zeta_{2n}^p = 0$  and we set  $f(z_1, \dots, z_n) = (z_1, \varepsilon z_1, \dots, z_n, \varepsilon_n z_n)$ , where  $\varepsilon_j$  are the roots  $\sqrt[p]{-1}$ . For any  $z$  we have  $1 + z_1^p + \varepsilon_1^p z_1^p + \dots + z_n^p + \varepsilon_n^p z_n^p = 1$ , and therefore  $f(\mathbb{C}^n)$  belongs to the hypersurface  $\zeta_1^p + \dots + \zeta_{2n}^p = 0$ .

For further results in this direction see the author's monograph, *Distribution of values of holomorphic mappings*, "Nauka", Moscow, 1982; English transl., Transl. Math. Monographs, vol. 61, Amer. Math. Soc., Providence, RI, 1985.

## §21. Boundary properties

Here we consider a number of questions that are related with the boundary properties of functions and mappings; in these questions the particularities of the position of boundaries relative to the complex structure of the space manifest themselves particularly brightly. We begin with the study of the boundary behavior of proper holomorphic mappings of strictly pseudoconvex domains, then we describe the structure of vector fields on boundaries and the influence of this structure on the properties of functions. Particular attention is paid to results obtained in recent years at Moscow University.

**61. Mappings of strictly pseudoconvex domains.** In the questions that are considered here there is an essential difference between simple pseudoconvex domains and strictly pseudoconvex ones, i.e., bounded domains in  $\mathbb{C}^n$  whose defining functions  $\varphi$  are  $C^2$ -smooth in a neighborhood of the boundary of the domain, and on the boundary itself the gradient  $\nabla\varphi \neq 0$ , and the Levi form  $H_z(\varphi, \omega)$  is strictly positive definite (see subsection 39).

This distinction appears, for example, in the consideration of proper holomorphic mappings. We recall that a holomorphic mapping  $f: D \rightarrow G$  of domains of  $\mathbb{C}^n$  is said to be proper if, for any set  $K \subset\subset G$ , the inverse image  $f^{-1}(K) \subset\subset D$ . Such a mapping is obviously surjective, and if it extends continuously to  $\bar{D}$ , then it transforms  $\partial D$  to  $\partial G$ . Since the inverse images of points of  $G$  are compact analytic sets in  $D$ , they are all finite. By the theorem of Remmert cited in subsection 55, the image of the critical set  $E = \{z \in D : J_f(z) = 0\}$  under such a mapping is an analytic set in  $G$ , and hence, does not partition  $G$ . It follows from this that for any point  $w \in G \setminus f(E)$  the number of inverse images  $f^{-1}(w)$  is finite and the same, since this is a continuous integer-valued function in  $G \setminus f(E)$ . For points  $w \in f(E)$  the number of inverse images decreases since some of them coalesce, so that  $f(E)$  plays the role of the branch set and the whole mapping  $f: D \rightarrow G$  is a ramified covering (cf. subsection 55).

The polydisc  $U^n$  (a pseudoconvex domain) can be mapped into itself properly and holomorphically, but not biholomorphically, for example by the mapping  $z \rightarrow (z_1^{m_1}, \dots, z_n^{m_n})$ , where the  $m_j$  are arbitrary positive integers. Some time ago there arose the curious conjecture that there does not exist such a mapping for the ball  $B^n$  for  $n > 1$  (a strictly pseudoconvex domain).

Recently, H. ALEXANDER<sup>(17)</sup> proved this conjecture, using some general properties of proper holomorphic mappings of strictly pseudoconvex domains. We give here the results of S. I. PINCHUK<sup>(18)</sup> that are related to this problem. We need the following

LEMMA. *If the function  $u$  is negative and plurisubharmonic in a domain  $D \subset \mathbb{C}^n$  with a boundary of class  $C^2$ , then there is a constant  $k > 0$  such that*

$$|u(z)| \geq k\delta(z, \partial D) \quad \text{for all } z \in D, \quad (1)$$

where  $\delta$  is Euclidean distance.

For  $n = 1$  (for subharmonic functions) this property was established by M. V. KELDYSH and M. A. LAVRENT'EV; for any  $n$  and in a more general situation it was proved by B. N. KHIMCHENKO; we do not give the proof.<sup>(19)</sup> We note that the estimate from the other side:  $|u(z)| \leq K\delta(z, \partial D)$  holds for any function of class  $C^1(\bar{D})$  that vanishes on the boundary.

Pinchuk's first result is the following.

THEOREM 1. *Let  $D$  and  $G$  be strictly pseudoconvex domains in  $\mathbb{C}^n$  ( $n > 1$ ) and  $f: D \rightarrow G$  a proper holomorphic mapping. If  $f$  extends in  $\bar{D}$  to a mapping of class  $C^1$ , then it is locally biholomorphic.*

◀ If  $f$  is not locally biholomorphic, then the Jacobian  $J_f(z) = 0$  on a nonempty analytic set  $E \subset \bar{D}$ , and by the theorem on compact singularities (subsection 31)  $E \cap \partial D \neq \emptyset$  (otherwise the holomorphic function  $1/J_f(z)$  would have a compact singularity in  $D$ , that does not partition  $D$ ). Let  $z^0 \in E \cap \partial D$ ; without loss of generality we may assume that  $z^0 = f(z^0) = 0$ . Suppose also that the domains in a neighborhood of the origin are given via strictly plurisubharmonic functions:  $D = \{\varphi(z) < 0\}$ ,  $G = \{\psi(w) < 0\}$ , and, without restricting generality, we may assume that

$$\varphi(z) = \operatorname{Re} z_n + |z|^2 + o(|z|^2), \quad \psi(w) = \operatorname{Re} w_n + |w|^2 + o(|w|^2) \quad (2)$$

(see Problem 21 to Chapter III).

<sup>(17)</sup>H. Alexander, *Proper holomorphic mappings in  $\mathbb{C}^n$* , Indiana Univ. Math. J. **26** (1977), 137–146.

<sup>(18)</sup>S. I. Pinchuk, *Proper holomorphic maps of strictly pseudoconvex domains*, Sibirsk. Mat. Z. **15** (1974), 909–917; English transl., Siberian Math. J. **15** (1974), 644–649.

<sup>(19)</sup>See B. N. Khimchenko, *The behavior of a superharmonic function near the boundary of a domain of type  $A^{(1)}$* , Differential'nye Uravneniya **5** (1969), 1845–1853; English transl., Differential Equations **5** (1969), 1371–1378.

Since the mapping  $f$  is holomorphic in  $D$  and is of class  $C^1(\bar{D})$ , then its coordinates have expansions of the form

$$f_\mu(z) = \sum_{\nu=1}^n a_{\mu\nu} z_\nu + \alpha_\mu(z), \quad \mu = 1, \dots, n, \quad (3)$$

where  $a_{\mu\nu} = \text{const}$ ,  $\alpha_\mu \in \mathcal{O}(D) \cap C^1(\bar{D})$ , and  $|\alpha_\mu(z)| = o(|z|)$ . We consider the function  $u = \psi \circ f \in C^1(\bar{D})$ ; since the mapping  $f$  is proper, then  $u|_{\partial D} = 0$ , and since the real tangent plane to  $\partial D$  at the point  $z = 0$  is given by the equation  $x_n = 0$ , then

$$u(z) = \left. \frac{\partial u}{\partial x_n} \right|_0 x_n + o(|z|).$$

Substituting (3) in (2), we will find

$$u(z) = \psi \circ f(z) = \text{Re} \sum_{\nu=1}^n a_{n\nu} z_\nu + \text{Re} \alpha_n(z) + \sum_{\mu=1}^n |f_\mu(z)|^2 + o(|z|^2)$$

and, comparing this expansion with the preceding one, we obtain that  $a_{n\nu} = 0$  for  $\nu = 1, \dots, n-1$  and that  $a_{nn}$  is a real number. The last expansion consequently takes the form

$$u(z) = a_{nn} x_n + \text{Re} \alpha_n(z) + \sum_{\mu=1}^n |f_\mu(z)|^2 + o(|z|^2). \quad (4)$$

The function  $u$  obviously satisfies the hypotheses of the lemma, from which it follows that  $a_{nn} \neq 0$ .

Since we have  $J_f(0) = 0$ , we conclude from this that the linear mapping  $'A: \mathbb{C}^{n-1} \rightarrow \mathbb{C}^{n-1}$ , given by the matrix  $(a_{\mu\nu})$ , where  $\mu, \nu = 1, \dots, n-1$ , is degenerate. Therefore there is a complex line  $'l \subset \mathbb{C}^{n-1}$  such that  $'A('l) = 0$ . We consider the complex line  $l_\tau = \{z \in \mathbb{C}^n: 'z \in 'l, z_n = -\tau\}$ , where  $\tau$  is a real number. The restriction  $\text{Re} \alpha_n|_{l_\tau}$  is a harmonic function on the open set  $l_\tau \cap D$ , and on the boundary of this set, i.e., for  $z \in l_\tau \cap \partial D$ , in view of (2) and (4) we have  $-\tau + |z|^2 + o(|z|^2) = 0$  and  $-a_{nn}\tau + \text{Re} \alpha_n(z) + \tau^2 \sum_{\mu=1}^n |a_{\mu n}|^2 + o(|z|^2) = 0$ , i.e.,  $\text{Re} \alpha_n = a_{nn}\tau + o(\tau)$  on this boundary. But from (2) we see that for all sufficiently small  $\tau > 0$  the point  $('0, -\tau) \in l_\tau \cap D$ , so that by the maximum principle for harmonic functions  $\text{Re} \alpha_n('0, \tau) = a_{nn}\tau + o(\tau)$  for all sufficiently small  $\tau > 0$ , and this contradicts the hypothesis  $\alpha_n(z) = o(|z|)$ . ►

If in the theorem we assume in addition that the domain  $G$  is simply connected, i.e., that the fundamental group  $\pi_1(G) = 0$ , then the mapping  $f$  of this theorem will be globally biholomorphic (in fact, from the already proved local biholomorphy and the properness of  $f$  it follows that  $f$  is

an unramified covering, and hence, we can use the monodromy theorem of subsection 21).

In the general case it is not possible to prove that  $f$  is globally biholomorphic; here is an example: the domains  $D = \{|z_1|^2 + |z_2|^4 + |z_2|^{-4} < 3\}$  and  $G = \{|w_1|^2 + |w_2|^2 + |w_2|^{-2} < 3\}$  in  $\mathbb{C}^2$  are strictly pseudoconvex, and the mapping  $f: D \rightarrow G$ , where  $f(z) = (z_1, z_2^2)$ , is proper and holomorphic, but not biholomorphic. However, for the case  $D = G$  we do have the following result.

**THEOREM 2.** *If  $D$  is a strictly pseudoconvex domain in  $\mathbb{C}^n$ , then any proper holomorphic mapping  $f: D \rightarrow D$  that can be extended to a mapping of class  $C^1(\bar{D})$  is biholomorphic.*

◀ The fundamental group  $\pi_1(D)$  can be assumed to be nontrivial (see above), but in view of the smoothness of  $\partial D$  it has a finite number of generators; let  $\gamma_1, \dots, \gamma_l$  be closed paths in  $D$  that represent these generators. By Theorem 1 the mapping  $f: D \rightarrow D$  is a covering, and the homomorphism  $f_*: \pi_1(D) \rightarrow \pi_1(D)$  induced by it is a monomorphism. By the theorem on the multiplicity of a covering (Theorem 3 of subsection 21) in order to prove that  $f$  is a homeomorphism it suffices to prove that  $f_*$  is an epimorphism, i.e., that  $\text{im } f_* = \pi_1(D)$ .

We consider the iterations  $f^\nu = f \circ f^{\nu-1}$  of the mapping  $f$  ( $\nu = 1, 2, \dots$ ;  $f^0$  is the identity mapping). Since the family  $\{f^\nu\}$  is uniformly bounded, then by Montel's theorem there is a subsequence  $f^{\nu_j}$ , converging uniformly on compact subsets of  $D$  to a holomorphic mapping  $g: D \rightarrow \bar{D}$ . In particular,  $f^{\nu_j} \rightarrow g$  uniformly on all the generators  $\gamma_k$  ( $k = 1, \dots, l$ ), and then  $f^{\nu_j}(\gamma_k)$  is homotopic to  $g(\gamma_k)$  for sufficiently large  $j$ , i.e.,  $f_*^{\nu_j} = g_*$  for all  $j \geq j_0$ . Since  $f_*$  is a monomorphism, then it follows from this that  $g_*$  is also a monomorphism. But  $f_*^{\nu_{j+1}} = f_*^{\nu_j} \circ f_*^{\nu_{j+1}-\nu_j}$ , and hence, for  $j \geq j_0$  we have  $g_* = g_* \circ f_*^{\nu_{j+1}-\nu_j}$ , from which since  $g_*$  is a monomorphism we conclude that  $f_*^{\nu_{j+1}-\nu_j}$  is the identity mapping, i.e., an epimorphism, and hence,  $f_*$  is an epimorphism. ▶

We conclude this section with an interesting theorem, proved in 1977–1979 by B. WONG and J. ROSAY. The simple proof that we give here is also due to S. I. PINCHUK.

**THEOREM 3.** *If the group of biholomorphic automorphisms of a strictly pseudoconvex domain  $D \subset \mathbb{C}^n$  is not compact, then  $D$  is biholomorphically equivalent to the ball.*

◀ Since the group  $\text{Aut } D$  is noncompact it follows that there exists a point  $z^0 \in D$  and the sequence  $f^\nu \in \text{Aut } D$  such that  $f^\nu(z^0) \rightarrow a \in \partial D$ . Since the domain  $D$  is bounded, then by Montel's theorem we may assume that  $f^\nu$  tends uniformly on compact subsets of  $D$  to a holomorphic mapping  $f$  in  $D$ . Since  $D$  is strictly pseudoconvex, it has a defining function  $\varphi$  that is

strictly plurisubharmonic in a neighborhood of  $\partial D$  (see subsection 39). The function  $\varphi \circ f$  is plurisubharmonic and nonpositive in a neighborhood of  $z^0$ , and  $\varphi \circ f(z^0) = 0$ , and therefore by the maximum principle  $\varphi \circ f(z) \equiv 0$ , and hence, the mapping  $f$  is constant.

Furthermore, without loss of generality, we may assume that  $a = 0$  and the function  $\varphi$  has the form

$$\varphi(z) = \operatorname{Re} z_n + |z|^2 + o(|z|^2). \quad (5)$$

We let  $\zeta^\nu$  denote a point of  $\partial D$  closest to  $a^\nu = f^\nu(z^0)$ , and let  $l^\nu$  denote the composition of the translation  $\zeta^\nu \rightarrow 0$  and a unitary transformation, taking the complex tangent plane  $T_{\zeta^\nu}^c(\partial D)$  to the plane  $w_n = 0$ . Then  $g^\nu = l^\nu \circ f^\nu$  will map  $D$  holomorphically onto a bounded domain  $G_\nu$ , and since  $a^\nu$  lies on the normal to  $\partial D$  at the point  $\zeta^\nu$ , then  $l^\nu(a^\nu) = g^\nu(z^0)$  has the form  $(0, -\delta_\nu)$ , where  $\delta_\nu > 0$ . By construction  $a^\nu \rightarrow 0$ , and hence,  $\delta_\nu \rightarrow 0$  as  $\nu \rightarrow \infty$ . We remark that the defining function  $\varphi_\nu = \varphi \circ (l^\nu)^{-1}$  of the domain  $G_\nu$  has the form

$$\varphi_\nu(w) = c_\nu \operatorname{Re} w_n + d_\nu |w|^2 + o(|w|^2),$$

where  $c_\nu$  and  $d_\nu$  tend to 1.

The domains  $G_\nu$  contract to the point  $w = 0$  as  $\nu \rightarrow \infty$ . In order to remove this, we set  $g^\nu = (g_n^\nu, g_n^\nu)$  and replace  $g^\nu$  by a sequence of biholomorphic mappings

$$F^\nu = (g_n^\nu / \sqrt{\delta_\nu}, g_n^\nu / \delta_\nu) \quad (6)$$

of the domain  $D$  onto the domains  $D_\nu = F^\nu(D)$  with defining functions of the form

$$\begin{aligned} \psi_\nu &= \frac{1}{\delta_\nu} \varphi_\nu(\sqrt{\delta_\nu} w, \delta_\nu w_n) \\ &= c_n \operatorname{Re} w_n + d_\nu (|w|^2 + \delta_\nu |w_n|^2) + \delta_\nu o(|w|^2). \end{aligned} \quad (7)$$

As  $\nu \rightarrow \infty$  the functions  $\psi_\nu$  on compact subsets of  $D$  converge uniformly to a function  $\psi(w) = \operatorname{Re} w_n + |w|^2$ , which is a defining function for a domain  $\tilde{D}$ , biholomorphically equivalent to the ball (see Problem 18 to Chapter I).

From (7) we see that on compact subsets of  $D$  for  $\nu$  sufficiently large  $\operatorname{Re} F_n^\nu(w) < 0$ , and  $F_n^\nu(z^0) = -1$  according to (6). By Montel's theorem it follows from this that from the sequence  $F_n^\nu$  we can extract a subsequence that converges uniformly on compact subsets of  $D$  to a holomorphic function  $F_n$ . For simplicity we denote this sequence also by  $F_n^\nu$ ; then, as we again see from (7), the mappings  $F^\nu$  are uniformly bounded on compact subsets of  $D$ , and again by Montel's theorem from the sequence  $F^\nu$  we can extract a subsequence that converges to a holomorphic mapping  $F: D \rightarrow \tilde{D}$ . The inverse mappings  $(F^\nu)^{-1}$  are uniformly bounded, and hence, we can extract



a subsequence of these mappings that converges on compact subsets of  $\tilde{D}$  to a holomorphic mapping  $\Phi$ . Since here  $F(z^0) = (0, -1)$  and  $\Phi(0, -1) = z^0$ , then  $F$  and  $\Phi$  are inverses of each other, and hence,  $F$  realizes a biholomorphic mapping of the domain  $D$  onto the domain  $\tilde{D} = \{\operatorname{Re} w_n + |w|^2 < 0\}$ , which is biholomorphically equivalent to the ball. ►

**62. Correspondence of boundaries.** If the boundaries of two domains  $D$  and  $G$  of the plane are Jordan curves, then by Carathéodory's theorem a conformal mapping  $f: D \rightarrow G$  extends to a homeomorphism of the closure of these domains, and if the boundaries are sufficiently smooth, then the extended mapping is smooth in the closure (see subsection 41 of Part I). It is easy to see that even Carathéodory's theorem does not extend to biholomorphic mappings of higher-dimensional domains. In fact, the mapping  $f: (z_1, z_2) \rightarrow (z_1, (z_1 - 1)z_2)$  transforms the bidisc  $D = \{|z_1| < 1, |z_2| < 1\}$  biholomorphically onto the domain  $G = \{|w_1| < 1, |w_2| < |w_1 - 1|\}$ , but the inverse mapping  $f^{-1}(w) = (w_1, \frac{w_2}{w_1 - 1})$  does not extend continuously to the boundary point  $(1, 0)$ , although both domains are Jordan.

In this example the domains  $D$  and  $G$  are pseudoconvex, but not strictly pseudoconvex. It turns out that for strictly pseudoconvex domains the property of extendability to the boundary is preserved—this is another situation in which the difference between pseudoconvex and strictly pseudoconvex domains appears. The first result in this direction was obtained by G. A. MARGULIS, who proved in 1971 that a biholomorphic mapping of strictly pseudoconvex domains extends to a homeomorphism of their closures.

The strongest result here was obtained by C. FEFFERMAN, who proved in 1974 that a biholomorphic mapping of strictly pseudoconvex domains with  $C^\infty$  boundaries extends to the closure to a mapping of the same class. This result was achieved by means of a profound study of geodesics in the Bergman metric of the domains under consideration.<sup>(20)</sup> Fefferman's proof was somewhat simplified by E. LIGOCKA and S. BELL.<sup>(21)</sup>

L. LEMPert<sup>(22)</sup> extended this theorem to domains with finite smoothness: if  $D$  and  $G$  are strictly pseudoconvex domains in  $\mathbb{C}^n$  with boundaries of class  $C^{k+1}$  ( $k \geq 2$ ), then any biholomorphic mapping  $f: D \xrightarrow{\text{onto}} G$  extends to a diffeomorphism of class  $C^{k+1/2}$  of the closures of these domains.

The theorems on extension to the boundary in the case of the plane easily carry over to proper holomorphic mappings. In the higher-dimensional case this is not so, and here there is only the result obtained independently by

<sup>(20)</sup>C. Fefferman, *The Bergman kernel and biholomorphic mappings of pseudoconvex domains*, Invent. Math. **26** (1974), 1–65.

<sup>(21)</sup>S. Bell and E. A. Ligocka, *A simplification and extension of Fefferman's theorem on biholomorphic mappings*, Invent. Math. **57** (1980), 283–289.

<sup>(22)</sup>L. Lempert, *La métrique de Kobayashi et la représentation des domaines sur la boule*, Bull. Soc. Math. France **109** (1981), no. 4, 427–474.

G. M. KHENKIN and S. I. PINCHUK. We go into the proof of this result in some detail, following PINCHUK.

LEMMA. Let  $D$  and  $G$  be strictly pseudoconvex domains in  $\mathbb{C}^n$ , and let  $f: D \rightarrow G$  be a proper holomorphic mapping. Then there exist constants  $k_1, k_2 > 0$  such that, for all  $z \in D$ ,

$$k_1 \delta(z, \partial D) \leq \delta(f(z), \partial G) \leq k_2 \delta(z, \partial D). \quad (1)$$

◀ Any strictly pseudoconvex domain in  $\mathbb{C}^n$  is the domain of the negative values of a plurisubharmonic function that is smooth in a neighborhood of the closure of this domain (see subsection 39). Let  $G = \{w \in \mathbb{C}^n: \psi(w) < 0\}$ , where  $\psi$  is such a function; then in view of its smoothness,  $|\psi(w)| \leq k\delta(w, \partial G)$ , or  $|\psi \circ f(z)| \leq k\delta(f(z), \partial G)$ , where  $z \in D$  and  $k > 0$  is some constant. But  $\psi \circ f$  is a negative plurisubharmonic function in  $D$ , and hence by the lemma of the preceding subsection  $|\psi \circ f(z)| \geq k'\delta(z, \partial D)$ . The left-hand side of (1) is proved.

To prove the right-hand side of (1) we consider the set  $E = \{z \in D: J_f(z) = 0\}$  of critical points of the mapping  $f$ ; by the theorem of Remmert cited in subsection 55,  $f(E)$  is an analytic set in  $G$ . For  $w \in G \setminus f(E)$  we set

$$\Psi(w) = \max_{z \in f^{-1}(w)} \varphi(z), \quad (2)$$

where  $\varphi$  is a plurisubharmonic function, whose set of negative values is the domain  $D$ . Since  $f$  is proper, the number of points of  $f^{-1}(w)$  is finite (and the same) for all  $w \in G \setminus f(E)$  and by property 3° of subsection 38  $\Psi$  is plurisubharmonic in  $G \setminus f(E)$ . Since  $f(E)$  is an analytic set, and the function  $\Psi$  is obviously bounded, then by the Grauert-Remmert theorem cited at the end of subsection 38 it extends plurisubharmonically to  $G$ .

By the same lemma from subsection 61 for the extended function we have  $|\Psi(w)| \geq k\delta(w, \partial G)$ , and since  $\Psi$  and  $\varphi$  are negative, then for  $w \in G \setminus f(E)$  (2) can be rewritten in the form  $|\Psi(w)| = \min_{z \in f^{-1}(w)} |\varphi(z)|$ , and since  $|\varphi(z)| \leq k'\delta(z, \partial D)$  in view of smoothness, then  $|\Psi(w)| \leq k' \min_{z \in f^{-1}(w)} \delta(z, \partial D)$ . Thus,  $k\delta(w, \partial G) \leq k' \min_{z \in f^{-1}(w)} \delta(z, \partial D)$  for all  $w \in G \setminus f(E)$ , and by continuity it also holds everywhere in  $G$ , i.e.,  $\delta(f(z), \partial G) \leq \frac{k'}{k} \delta(z, \partial D)$  for all  $z \in D$ . ▶

THEOREM. Any proper holomorphic mapping  $f: D \rightarrow G$  of strictly pseudoconvex domains in  $\mathbb{C}^n$  extends to a continuous mapping of the closures of these domains, and the extended mapping satisfies a Lipschitz condition in  $\bar{D}$  with exponent  $1/2$ :

$$|f(z') - f(z'')| \leq k|z' - z''|^{1/2} \quad \text{for all } z', z'' \in \bar{D}. \quad (3)$$

◀ We shall prove this theorem under the additional assumption that the domain  $G$  is geometrically strictly pseudoconvex.<sup>(23)</sup> Since the boundary

<sup>(23)</sup>For a complete proof see the paper by Pinchuk, cited at the beginning of subsection 61.

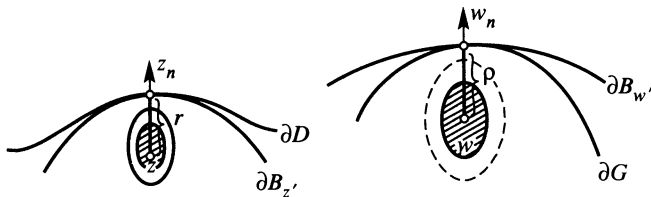

FIGURE 53

$\partial D$  is of class  $C^2$ , then for any point  $z \in D$ , sufficiently close to  $\partial D$ , there is a ball  $B_{z'} \subset D$  with center  $z'$  such that  $\delta(z, \partial D) = \delta(z, \partial B_{z'})$ , and since  $G$  is geometrically convex, then for any point  $w \in G$  there is a ball  $B_w \supset G$  such that  $\delta(w, \partial G) = \delta(w, \partial B_w)$  (Figure 53).

We estimate the moduli of the derivatives of the components of the mapping  $f$  at an arbitrary point  $z$ , sufficiently close to  $\partial D$ . Without loss of generality we assume that the center of the corresponding ball  $z' = 0$  and that  $z$  lies on the  $z_n$  axis. As we saw in subsection 57, the Carathéodory metric of the ball  $B^n = \{|z| < R\}$  at the point  $z = (0, z_n)$  is given by the form

$$ds^2 = (n + 1) \left( \frac{|dz|^2}{R^2 - |z_n|^2} + \frac{|z_n|^2 |dz_n|^2}{(R^2 - |z_n|^2)^2} \right) \tag{4}$$

(it coincides with the Bergman metric of the ball; see formula (18) of subsection 56). If we let  $R - |z_n| = r$ , then we can conclude from this that there exist constants  $\lambda_1$  and  $\lambda_2$ , depending on  $R$  and such that the ball in the Carathéodory metric  $c_{B^n}$  with center  $z = (0, z_n)$  and radius  $\varepsilon$  is enclosed between two ellipsoids

$$E(\lambda_j \varepsilon \sqrt{r}, \lambda_j \varepsilon r) = \left\{ \sum_{\nu=1}^{n-1} \frac{|z_\nu|^2}{r} + \frac{|z_n - z_n^0|^2}{r^2} = (\lambda_j \varepsilon)^2 \right\}, \quad j = 1, 2 \tag{5}$$

(all the semi-axes of these ellipsoids, except for the  $n$ th one, are equal to  $\lambda_j \varepsilon \sqrt{r}$ , while the  $n$ th semi-axis is equal to  $\lambda_j \varepsilon r$ ).

We apply this to our situation (Figure 53). In our case the radius  $R$  of the ball  $B_{z'}$  depends on the domain  $D$ , the quantity  $r = \delta(z, \partial D)$ , and, by (5) and the properties of the Carathéodory metric for  $\varepsilon$  sufficiently small we have

$$E(\lambda_1 \varepsilon \sqrt{r}, \lambda_1 \varepsilon r) \subset B_z^{c_{B_{z'}}}(\varepsilon) \subset B_z^{c_D}(\varepsilon),$$

where  $B_z^d(\varepsilon)$  denotes the ball in the metric  $d$  with center  $z$  and radius  $\varepsilon$ . Analogously for the domain  $G$ , setting  $w = f(z)$  and  $\rho = \delta(w, \partial G)$ , we will have

$$B_w^{c_G}(\varepsilon) \subset B_w^{c_{B_w'}}(\varepsilon) \subset E(\lambda_1 \varepsilon \sqrt{\rho}, \lambda_2 \varepsilon \rho)$$

(we again assume that  $w' = 0$  and  $w$  lies on the  $w_n$  axis; see Figure 53).

By the contractability property of the Carathéodory metric for holomorphic mappings  $f(B_z^{c_D}(\varepsilon)) \subset B_w^{c_G}(\varepsilon)$ . Moreover, by the lemma  $\rho < k_2r$ , and hence,

$$f(E(\lambda_1\varepsilon\sqrt{r}, \lambda_1\varepsilon r)) \subset E(\lambda_2\varepsilon\sqrt{k_2r}, \lambda_2\varepsilon k_2r). \tag{6}$$

Considering the restrictions of the coordinates  $f_\mu$  of the mapping  $f$  to lines that pass through the point  $z$ , and applying the Schwarz lemma to the resulting functions of one variable, we obtain that

$$\left| \frac{\partial f_\mu}{\partial z_\nu} \right|_z \leq \frac{\lambda_2\varepsilon\sqrt{k_2r}}{\lambda_1\varepsilon r} = \frac{c}{\sqrt{r}} = \frac{c}{\sqrt{\delta(z, \partial D)}}, \tag{7}$$

where the constant  $c$  depends only on the domains  $D$  and  $G$ . Since the derivatives  $\partial f_\mu/\partial z_\nu$  are bounded on compact subsets of  $D$ , we may assume that the estimate (7) holds<sup>(24)</sup> in the whole domain  $D$ .

It suffices to prove the inequality (3) for pairs of points of the domain  $D$ , the distance between which does not exceed some positive constant  $l_0$ . Let  $z', z''$  be arbitrary points of  $D$  and  $|z' - z''| = l \leq l_0$ ; we choose points  $z'_1, z''_1$  such that the intervals  $[z', z'_1]$  and  $[z'', z''_1]$  belong to  $D$ , have length  $l$ , and the distances  $\delta(z'_1, \partial D), \delta(z''_1, \partial D)$  are not less than  $l$  (this can always be done). We let  $\gamma: [0, 1] \rightarrow [z', z'_1]$  denote a linear mapping such that  $\gamma(0) = z', \gamma(1) = z'_1$ ; obviously  $|\gamma'(t)| = l$ . Since  $\delta(\gamma(t), \partial D) \geq tl$  for all  $t \in [0, 1]$ , then by the estimate (7)

$$|f(z'_1) - f(z')| \leq \int_0^1 \frac{c|\gamma'(t)|}{\sqrt{tl}} dt = 2c\sqrt{l}.$$

In exactly the same way we obtain the estimate  $|f(z''_1) - f(z'')| \leq 2c\sqrt{l}$ .

Furthermore, the length of the interval  $[z'_1, z''_1]$  is not greater than  $3l$ , and its ends are not less than  $l$  away from  $\partial D$ . Using the facts that the boundary  $\partial D$  is  $C^2$  and the curvature of its sections by two-dimensional planes is bounded, we can assert that for sufficiently small  $l_0$  for all  $z \in [z'_1, z''_1]$  we have  $\delta(z, \partial D) \geq l/2$ . From this, again using the estimate (7), we deduce that  $|f(z'_1) - f(z''_1)| \leq 3c\sqrt{2l}$ , and, combining these estimate, we find that

$$|f(z') - f(z'')| < c\sqrt{l} = c|z' - z''|^{1/2},$$

where  $c$  is a constant that depends only on the domains  $D$  and  $G$  and the mapping under consideration.

It remains to notice that the last estimate, which is valid for all points  $z', z'' \in D$ , implies the possibility of the continuous extension of  $f$  to the closure of the domain  $D$ , and in the closure the extended mapping will satisfy the same estimate. ►

**REMARK.** From the proof of the theorem we see that a local variant is also true: if the domains  $D$  and  $G$  satisfy the hypotheses of the theorem

<sup>(24)</sup>With a constant depending on  $D, G$ , and the mapping under consideration.

in some neighborhoods of points of their boundaries and if  $f: D \rightarrow G$  is a proper holomorphic mapping, transforming one neighborhood into another, then in the first neighborhood  $f$  extends to  $\partial D$  with a Lipschitz condition with exponent  $1/2$ .

**63. A symmetry principle.** In order to study the boundary behavior of mappings of domains with real-analytic boundaries it has turned out to be very fruitful to apply a higher-dimensional symmetry principle. This principle was proposed by S. I. PINCHUK in 1975<sup>(25)</sup> and later developed by S. WEBSTER.<sup>(26)</sup> Here we present the foundations of this method and we give examples of how to apply it.

A real hypersurface  $S$  is said to be *real-analytic* in a polydisc with center  $a$ , which for simplicity we take to be 0, if it is defined in the form  $S = \{z \in U : \varphi(z) = 0\}$  and

$$\varphi(z) = \Phi(z, \bar{z}) = \sum_{|k|, |l| \geq 0} c_{kl} z^k \bar{z}^l, \tag{1}$$

where  $k = (k_1, \dots, k_n)$ ,  $l = (l_1, \dots, l_n)$  are multi-indices and the series converges in the polydisc  $U \times U \subset \mathbb{C}^{2n}$ . The condition that  $\varphi$  be real obviously reduces to the equalities  $\bar{c}_{kl} = c_{lk}$  for all  $k$  and  $l$ . The surface  $S$  is said to be strictly pseudoconvex if the function  $\varphi$  is strictly plurisubharmonic and  $\nabla\varphi \neq 0$  on  $S$  (see subsection 39).

We begin with a higher-dimensional generalization of the Schwarz symmetry principle (see subsection 42 of Part I).

**THEOREM 1** (S. I. Pinchuk). *Let  $S = \{\varphi(z) = 0\}$  and  $S' = \{\psi(z) = 0\}$  be surfaces that are real-analytic and strictly pseudoconvex respectively in neighborhoods  $U$  and  $V$  in  $\mathbb{C}^n$ , and  $D = \{z \in U : \varphi(z) < 0\}$  the domain adjoining  $S$ . Then any mapping  $f: D \rightarrow \mathbb{C}^n$ , holomorphic in  $D$ , of class  $C^1$  in  $D \cup S$ , and such that  $f(S) \subset S'$ , extends holomorphically to  $S$ .*

◀ It suffices to prove that  $f$  extends to a neighborhood of an arbitrary point  $\zeta \in S$ , which, like  $f(\zeta)$ , can be assumed to be 0. In order not to clutter up the proof with technical details, we restrict ourselves to the case  $n = 2$ .

Let  $\Psi(w, \bar{w})$  be a holomorphic function in  $V \times V$  such that  $\psi(w) = \Psi(w, \bar{w})$ . Then the condition  $f(S) \subset S'$  is written in the form

$$\Psi(f(z), \overline{f(z)}) = 0 \quad \text{for all } z \in S. \tag{2}$$

Let  $u = \frac{\partial\varphi}{\partial z_2} \frac{\partial}{\partial z_1} - \frac{\partial\varphi}{\partial z_1} \frac{\partial}{\partial z_2}$  denote the tangential Cauchy-Riemann operator on  $S$  (see subsection 31). Since by hypothesis the functions  $f_\nu \in \mathcal{O}(D) \cap C^1(\bar{D})$ ,

<sup>(25)</sup>S. I. PINCHUK, *On the analytic continuation of holomorphic mappings*, Mat. Sb. **98** (140) (1975), no. 3, 416–435; English transl., Math. USSR-Sb. **27** (1975), 375–392.

<sup>(26)</sup>S. M. Webster, *On the mapping problem for algebraic real hypersurfaces*, Invent. Math. **43** (1977), 53–68. See also the article by M. Beals, C. Fefferman, and R. Grossman, *Strictly pseudoconvex domains in  $\mathbb{C}^n$* , Bull. Amer. Math. Soc. (N.S.) **8** (1983), 125–322.

then  $u\bar{f} = (uf_1, uf_2) = 0$  on  $S$ , and, applying this operator to (2), we obtain that

$$\sum_{\nu=1}^2 \frac{\partial \Psi}{\partial w_\nu}(f(z), \overline{f(z)})uf_\nu z = 0 \quad \text{for all } z \in S. \tag{3}$$

Now we need to solve the system of equations (2)–(3) in a neighborhood of the point  $z = 0$  relative to  $\overline{f_1(z)}$  and  $\overline{f_2(z)}$ . By the implicit function theorem the system is solvable if the determinant<sup>(27)</sup>

$$\Delta(z) = \begin{vmatrix} \frac{\partial \Psi}{\partial \bar{w}_1}(f(z)) & \frac{\partial \Psi}{\partial \bar{w}_2}(f(z)) \\ \sum_{\nu=1}^2 \frac{\partial^2 \Psi}{\partial w_\nu \partial \bar{w}_1}(f(z))uf_\nu(z) & \sum_{\nu=1}^2 \frac{\partial^2 \Psi}{\partial w_\nu \partial \bar{w}_2}(f(z))uf_\nu(z) \end{vmatrix} \neq 0. \tag{4}$$

To prove this we remark first that  $uf \neq 0$  on  $S$ . In fact, if at some point of  $S$  we simultaneously have

$$uf_1 = \frac{\partial f_1}{\partial z_1} \frac{\partial \varphi}{\partial z_2} - \frac{\partial f_1}{\partial z_2} \frac{\partial \varphi}{\partial z_1} = 0, \quad uf_2 = \frac{\partial f_2}{\partial z_1} \frac{\partial \varphi}{\partial z_2} - \frac{\partial f_2}{\partial z_2} \frac{\partial \varphi}{\partial z_1} = 0,$$

then at this point the Jacobian  $\partial(f_1, f_2)/\partial(z_1, z_2) = 0$  (by assumption  $\nabla \varphi \neq 0$ ). But, as we saw in the proof of Theorem 1 of subsection 61, since  $S$  and  $S'$  are strictly pseudoconvex it follows that the Jacobian is different from zero on  $S$ . Furthermore, if  $uf \neq 0$ , then according to (3) there is a function  $h \neq 0$  on  $S$  such that

$$\frac{\partial \Psi}{\partial w_1}(f(z)) = h(z)uf_2(z), \quad \frac{\partial \Psi}{\partial w_2}(f(z)) = -h(z)uf_1(z)$$

and, substituting this in (4), we will obtain

$$\Delta(z) = \overline{h(z)} \sum_{\mu, \nu=1}^2 \frac{\partial^2 \Psi}{\partial w_\mu \partial \bar{w}_\nu} \Big|_{f(z)} uf_\mu \overline{uf_\nu}.$$

Since  $\Psi$  is a strictly plurisubharmonic function and  $uf \neq 0$ , then  $\Delta(z) \neq 0$  on  $S$  (see subsection 39).

Thus, the implicit function theorem is applicable, and we find from the system (2)–(3) that in some neighborhood  $U' \ni 0$

$$\overline{f_\nu(z)} = g_\nu(f(z), uf(z)), \quad \nu = 1, 2, \tag{5}$$

where the functions  $g_\nu$  are holomorphic in a neighborhood of the point  $(0, uf(0)) \in \mathbb{C}^4$ . We now fix a vector  $\omega \in \mathbb{C}^2$  such that the complex lines  $l_\lambda = \{z = \omega\zeta + \lambda\}$  for sufficiently small  $\lambda \in \mathbb{C}^2$  intersect  $S \cap U$  transversally in an analytic arc  $\gamma_\nu$ . The functions  $\partial \varphi / \partial z_\mu$  are real-analytic in  $\zeta$  in a neighborhood of  $\gamma_\lambda$ , and  $f_\nu(\omega\zeta + \lambda)$  are holomorphic in the part of this neighborhood where  $\varphi(\omega\zeta + \lambda) < 0$ , and hence the  $uf_\nu|_{l_\lambda}$  are also holomorphic in this part. From (5) it follows that on  $\gamma_\lambda$  the functions  $f_\nu(\omega\zeta + \lambda)$

<sup>(27)</sup>Here we have taken into account that  $\frac{\partial \Psi(w, \omega)}{\partial \omega_\nu} \Big|_{\omega=\bar{w}} = \frac{\partial \Psi}{\partial \bar{w}_\nu}(w)$ .

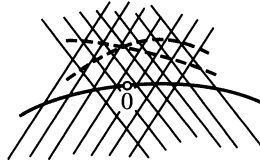

FIGURE 54

also take values on real-analytic arcs, and by the Schwarz symmetry principle for one variable these functions extend holomorphically to some (two-sided) neighborhood of  $\gamma_\lambda$ .

Finally, we change  $\omega$  somewhat, by taking  $\omega'$  complex-linearly independent with  $\omega$ , and in just the same way we prove that the functions  $f_\nu$  extend holomorphically beyond the limits of  $D$  onto each complex line of direction of  $\omega'$  (Figure 54). By means of a nondegenerate linear transformation we map  $\omega$  and  $\omega'$  into the directions of the new coordinate axes. Then by Hartogs's theorem (subsection 6) we can conclude that the functions  $f_\nu$  are holomorphic in a neighborhood of the point  $z = 0$ . ▶

We proceed to present the symmetry principle in the form proposed by WEBSTER. Suppose we are given a real-analytic surface  $S = \{\varphi(z) = 0\}$  and a point  $z$  close to it; the points of the set

$$Q_z = \{w \in U : \Phi(\bar{z}, w) = 0\} \tag{6}$$

are said to be *symmetric* with  $z$  relative to  $S$ , where  $\Phi$  is the function from (1). For  $n = 1$  symmetric with the point  $z$  will be a point; for  $n > 1$  these points form a complex hypersurface. In particular, if  $S = \{z \in \mathbb{C}^n : |z| = 1\}$  is the unit sphere, then  $Q_z = \{w \in \mathbb{C}^n : \sum_{\nu=1}^n \bar{z}_\nu w_\nu = 1\}$  is the complex hyperplane  $\{(w, z) = 1\}$ , complex orthogonal to the vector  $z$ . Here if  $|z| < 1$ , then for all  $w \in Q_z$  by the Schwarz inequality  $|w| \geq 1/|z| > 1$ , so that  $Q_z$  lies outside the sphere  $S$ , and if  $|z| > 1$ , then  $Q_z$  intersects it (to see this, it suffices to consider a complex line passing through  $z$  and the origin).

\* Prove that for  $n = 1$ , when  $S$  is a segment of a line or an arc of a circle, this symmetry coincides with the usual one. \*

As is evident from the above-mentioned property of the coefficients of the series (1),  $\Phi(\bar{z}, w) = \overline{\Phi(w, \bar{z})}$ , from which it follows that  $Q_w = \{z \in U : \Phi(\bar{w}, z) = 0\}$  can also be defined by the equation  $\Phi(\bar{z}, w) = 0$ . We have obtained the following property of the symmetry:

$$\text{if } w \in Q_z, \text{ then } z \in Q_w. \tag{7}$$

**THEOREM 2.** *Suppose that in  $\mathbb{C}^n$  we are given two real-analytic hypersurfaces  $S_\nu = \{z \in U_\nu : \varphi_\nu(z) = 0\}$  and a holomorphic mapping  $f: U_1 \rightarrow U_2$  such that  $f(S_1) \subset S_2$ . Then for any point  $z \in U_1$ ,*

$$f(Q_z^1) \subset Q_{f(z)}^2, \tag{8}$$

where  $Q_z^1$  is the surface symmetric with such a  $z$  relative to  $S_1$  and  $Q_{f(z)}^2$  is defined analogously.

◀ Let  $\Phi_\nu$  be a holomorphic function in  $U_\nu \times U_\nu$ , related to  $\varphi_\nu$  as in (1), and let  $\bar{f}_\mu(z) = \overline{f_\mu(\bar{z})}$  be a holomorphic function in  $U_1$  whose Taylor coefficients are complex conjugate to the corresponding coefficients of  $f_\mu$  ( $\mu = 1, \dots, n$ ) (as above, we assume that the  $U_\nu$  are polydiscs with center at 0). Let  $A_1 = \{\Phi_1(z, w) = 0\}$  denote an analytic set in  $U_1 \times U_1$  of dimension  $2n - 1$ , and assume without loss of generality that it is irreducible, and  $\Phi_1$  is its defining function. This set contains  $S_1 = \{\Phi_1(z, \bar{z}) = 0\} = A_1 \cap \{w = \bar{z}\}$  as a totally real submanifold of it of (real) dimension  $2n - 1$  (see subsection 17).

The function  $\Phi_2(f(z), \bar{f}(w))$ , holomorphic in  $U_1 \times U_1$ , vanishes on  $S_1$ , since  $w = \bar{z}$  and  $\bar{f}(w) = \overline{f(z)}$  there, and hence,  $\Phi_2(f(z), \bar{f}(w)) = \Phi_2(f(z), \bar{f}(z)) = 0$ . By the uniqueness theorem that we shall discuss in subsection 66, it follows from this that  $\Phi_2(f(z), \bar{f}(w))$  also vanishes on the whole set  $A_1$ . But then, by the Weierstrass division theorem (subsection 23) there is a function  $h \in \mathcal{O}(U_1 \times U_1)$  such that

$$\Phi_2(f(z), \bar{f}(w)) = h(z, w)\Phi_1(z, w) \quad \text{for all } (z, w) \in U_1 \times U_1. \quad (9)$$

The assertion of the theorem follows from this: if  $z \in U_1$  and  $Q_z^1 = \{w \in U_1 : \Phi_1(z, \bar{w}) = 0\}$ , then, for any point  $w \in Q_z^1$ , according to (9) the image  $f(w)$  satisfies the relation  $\Phi_2(f(z), \bar{f}(\bar{w})) = \Phi_2(f(z), \overline{f(w)}) = 0$ , i.e., belongs to the set  $Q_{f(z)}^2$ . ▶

**COROLLARY.** *If under the hypotheses of the preceding theorem  $f$  is a biholomorphic mapping, then  $f(Q_z^1) = Q_{f(z)}^2$  at all points  $z \in U_1$ .*

◀ For the proof it suffices to apply Theorem 2 to both  $f$  and its inverse  $f^{-1}$ . ▶

Thus, for biholomorphic mappings of neighborhoods of real-analytic surfaces there are invariants—the sets of points of symmetry relative to these surfaces. For  $n = 1$  these sets are points, and the presence of these invariants is not very essential. However, for  $n > 1$  the invariants are of positive dimension and turn out to have a significant influence on the structure of the mappings.

As the simplest example of how to use the invariance of sets of symmetry we give the following result, which is very unusual from the point of view of the theorem of functions of one variable. It turns out that if a however small piece of a ball adjoining the boundary is mapped biholomorphically onto such a piece, then the mapping must be linear-fractional. This result is reminiscent of the classical theorem of Liouville that for  $n > 2$  any conformal mapping of a neighborhood  $U \subset \mathbb{R}^n$  extends to a linear-fractional mapping of the whole space.



**THEOREM 3.** *Let  $B = \{z \in \mathbb{C}^n : |z| < 1\}$  be the ball and let  $U = \{|z - a| < \varepsilon\}$  be a neighborhood of a boundary point  $a$  of  $B$ . If  $f : B \cap U \rightarrow \mathbb{C}^n$ ,  $f \in C^1(\overline{B} \cap U)$ , is a biholomorphic mapping such that  $f(\partial B \cap U) \subset \partial B$ , then for  $n > 1$  this mapping extends to a biholomorphic automorphism of the whole ball, and hence, is linear-fractional.*

◀ By Pinchuk's theorem the mapping  $f$  extends holomorphically to a neighborhood of  $a$ , say  $U$  itself. We assume first that  $n = 2$ ; then for any point  $w \in U \setminus \overline{B}$  and sufficiently close to  $a$  the set  $Q_w$  of points symmetric with  $w$  will be a complex line, orthogonal to the vector  $w$  and intersecting the sphere  $S = \partial B$  in a circle  $\gamma$  (see the example given above). By the Corollary to Theorem 2 the mapping  $f$  takes this line into the set  $Q_{f(w)}$ , which is also a complex line (Figure 55). Since  $f$  maps  $S$  into itself, then  $f(\gamma) = Q_{f(w)} \cap S$ , i.e., it is again a circle, and by an elementary fact from the theory of functions of one variable the restriction  $f|_{Q_w}$  is a linear-fractional function.

The same thing can be said about the restriction of  $f$  to complex lines parallel to  $Q_w$  and sufficiently close to it, and also about its restriction to some family of parallel lines in another direction. By a nondegenerate linear transformation these families can be mapped into the families of complex lines parallel to the  $z_1$  and  $z_2$  coordinate axes. Then the function  $f$  will be linear-fractional in  $z_2$  for any fixed  $z_1$  belonging to some neighborhood  $u_1$ , and linear-fractional in  $z_1$  for any fixed  $z_2$  belonging to another neighborhood  $u_2$ . By Hartogs's theorem (subsection 6) it is linear-fractional in  $u_1 \times u_2$ , and hence, everywhere in  $\mathbb{C}^2$ .

Arguing by induction, we assume that the theorem is true for some  $n - 1 \geq 2$ . Fixing a point  $w \in U \setminus \overline{B}$  that is sufficiently close to  $a$ , we note that  $Q_w$  will be a complex plane, intersecting  $B$  in a ball of complex dimension  $n - 1$ . By the Corollary to Theorem 2 the mapping  $f$  will map it into a plane  $Q_{f(w)}$  of the same dimension, and by the hypothesis of Theorem 3  $f(B \cap Q_w) = B \cap Q_{f(w)}$ , i.e., another  $(n - 1)$ -dimensional ball. Therefore the restriction  $f|_{Q_w}$  will be a linear-fractional function. The same thing can be said about the restriction of  $f$  to planes parallel to  $Q_w$  and sufficiently close

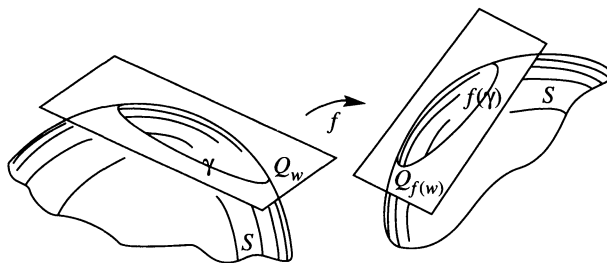

FIGURE 55

to it, and also about the restriction of this function to some family of parallel complex lines transversal to  $Q_w$ . And again, applying Hartogs's theorem, we find that the function  $f$  is linear-fractional. ►

The history of this theorem is rather interesting. In 1974 H. ALEXANDER published a rather complicated proof of it, which was then significantly simplified by S. I. PINCHUK, who used his symmetry principle (discussed in the previous edition of this book). The very simple proof given above is due to S. WEBSTER. When it was published Alexander's theorem made a great impression because of its unusual formulation. However, it later became clear that the effect that the local preservation of a sphere under biholomorphic mappings at at least one point implies its global preservation had already been discovered by H. POINCARÉ in 1907. Poincaré wrote the equation of the sphere in  $\mathbb{C}^2$  in the form  $y_2 = |z_1|^2$  (see Problem 18 to Chapter I) and starting from local conditions of the invariance of a piece of this sphere under biholomorphic mappings computed that such mappings must be linear-fractional.

Later this result was significantly strengthened.

**THEOREM (S. I. Pinchuk).**<sup>(28)</sup> *Let  $D$  and  $G \subset \mathbb{C}^n$  be strictly pseudoconvex domains with simply connected real-analytic boundaries, and let  $U$  be a neighborhood of a point  $a \in \partial D$ . Then any nonconstant holomorphic mapping  $f: U \rightarrow \mathbb{C}^n$  such that  $f(U \cap \partial D) \subset \partial G$  extends to a biholomorphic mapping of  $D$  onto  $G$ .*

We note in conclusion that Webster, in the paper cited above, used the symmetry principle to prove that biholomorphic mappings of domains in  $\mathbb{C}^n$  defined by the conditions  $P_\nu(z, \bar{z}) = 0$ , where  $P_\nu$  are polynomials, is necessarily realized by algebraic functions.

**64. Vector fields.** In order to study the boundary properties of functions and mappings it is useful to consider in detail the structure of vector fields on the boundaries of domains or, more generally, on smooth submanifolds of  $\mathbb{C}^n$ . Suppose that such a manifold  $M$  is locally, in a neighborhood  $U$ , represented by the equations

$$\varphi_1(z) = \cdots = \varphi_k(z) = 0, \quad (1)$$

where the  $\varphi_\mu$  are real-valued functions of class  $C^1$  and in  $U$

$$d\varphi_1 \wedge \cdots \wedge d\varphi_k(z) \neq 0, \quad (2)$$

i.e., the vectors  $\nabla\varphi_1, \dots, \nabla\varphi_k$  are real-linearly independent (see subsection 17). Then the real dimension of  $M$  is equal to  $r = 2n - k$ .

Recall that a tangent vector to  $M$  at a point  $\zeta \in M$  is of the form

$$X_\zeta = \sum_{\nu=1}^n a_\nu(\zeta) \frac{\partial}{\partial z_\nu} + \overline{a_\nu(\zeta)} \frac{\partial}{\partial \bar{z}_\nu} \quad \text{if } X_\zeta(\varphi_\mu) = 0 \text{ for } \mu = 1, \dots, k.$$

Taking some license we shall use the term "tangent vector" to refer not to  $X_\zeta$ , but to the vector

$$Z_\zeta = \sum_{\nu=1}^n a_\nu(\zeta) \frac{\partial}{\partial z_\nu} \quad \text{if } \operatorname{Re} Z_\zeta(\varphi_\mu) = 0 \text{ for } \mu = 1, \dots, k. \quad (3)$$

<sup>(28)</sup>S. I. Pinchuk, *On holomorphic mappings of real-analytic hypersurfaces*, Mat. Sb. 105 (147) (1978), no. 4, 574–593; English transl., Math. USSR-Sb. 34 (1978), 503–519.

The vector (3) is called a *complex tangent vector* if both it and  $iZ_\zeta$  are tangent vectors, i.e.,  $Z_\zeta(\varphi_\mu) = 0$  for  $\mu = 1, \dots, k$ . The set of tangent vectors to  $M$  at a point  $\zeta$  forms the tangent plane  $T_\zeta(M)$ , and the set of complex tangent vectors forms the complex tangent plane  $T_\zeta^c(M) = T_\zeta(M) \cap iT_\zeta(M)$  (see subsection 17).

Obviously  $\dim_{\mathbb{R}} T_\zeta(M) = r$ —the real dimension of  $M$ , while the dimension of  $T_\zeta^c(M)$  depends not only on  $r$ , but also on how  $T_\zeta(M)$  sits inside  $\mathbb{C}^n$ . Indeed (see subsection 17), if among the vectors  $\nabla\varphi_\mu$  there are  $k' \leq k$  complex linearly independent vectors, i.e., there exists a set of indices  $j_1, \dots, j_{k'}$  belonging to  $1, \dots, k$  such that

$$\bar{\partial}\varphi_{j_1} \wedge \dots \wedge \bar{\partial}\varphi_{j_{k'}}(\zeta) \neq 0 \tag{4}$$

and the number  $k'$  with this property is maximal, then  $\dim_{\mathbb{C}} T_\zeta^c(M) = n - k'$ .

If the point  $\zeta \in M$  is permitted to vary, then the set of tangent planes  $T_\zeta$  and  $T_\zeta^c$  form the *bundles*  $T(M)$  and  $T^c(M)$ . The sections of these bundles, i.e., functions (continuous or of class  $C^1$ ) that associate to each point  $\zeta \in M$  the corresponding tangent vector, are called *vector fields* (see subsection 27). In the consideration of complex vector fields it is usually required that the dimension of  $T_\zeta^c(M)$  be the same for all points  $\zeta \in M$ . Manifolds that possess this property are called *Cauchy-Riemann manifolds* or, simply, *CR-manifolds*. The (complex) dimension of  $T_\zeta^c(M)$ , which is the same for all  $\zeta \in M$ , is called the CR-dimension of  $M$  (notation:  $\dim_{\text{CR}} M$ ).

EXAMPLES. Trivial examples of a CR-manifold are the *totally real*<sup>(29)</sup> manifolds  $M$ , for which  $T_\zeta^c(M) = 0$  for all  $\zeta \in M$ . All the real hypersurfaces  $S \subset \mathbb{C}^n$  of class  $C^1$  are also CR-manifolds: for them  $\dim T_\zeta^c(S) = n - 1$  at each point. All the *generating* manifolds  $M \subset \mathbb{C}^n$  are also of this type: for them condition (4) holds at each point with  $k' = k$ , and, hence,  $\dim_{\text{CR}}(M) = n - k = r - n$ . All the *maximally complex* manifolds are CR-manifolds: for them  $\dim_{\text{CR}} M = \frac{1}{2}(\dim_{\mathbb{R}} M - 1)$ .

The real-two-dimensional manifold  $M = \{z \in \mathbb{C}^2: z_2 = |z_1|^2\}$  is not a CR-manifold: for it  $T_\zeta^c(M) = 0$  for  $\zeta \neq 0$ , and  $T_0^c(M)$  consists of the vectors  $a \frac{\partial}{\partial z_1}$  ( $a \in \mathbb{C}$ ) and is the complex line  $\{z_2 = 0\}$ .

\* Prove that the tangential Cauchy-Riemann equations for a function of class  $C^1$  on a GENERATING manifold (1) have the form  $\bar{\partial}f \wedge \bar{\partial}\varphi_1 \wedge \dots \wedge \bar{\partial}\varphi_k = 0$ . \*

For the study of complex functions on manifolds  $M \subset \mathbb{C}^n$  in addition to  $T_\zeta$  and  $T_\zeta^c$  we consider the *generic tangent plane*  $\mathfrak{T}_\zeta(M)$ , consisting of the vectors of the form

$$Z_\zeta = \sum_{\nu=1}^n a_\nu(\zeta) \frac{\partial}{\partial z_\nu} + b_\nu(\zeta) \frac{\partial}{\partial \bar{z}_\nu}: \quad Z_\zeta(\varphi_\mu) = 0 \text{ for } \mu = 1, \dots, k. \tag{5}$$

<sup>(29)</sup>Apropos the terms used here for different manifolds see subsection 17.

The sections of the bundle  $\mathfrak{X}(M)$ , i.e., the *generic vector fields* are also considered more conveniently on CR-manifolds.

Suppose we are given a CR-manifold  $M \subset \mathbb{C}^n$ , where  $\dim_{\mathbb{R}} M = r$ ,  $\dim_{\mathbb{C}\mathbb{R}} M = l$ , and that it is given in the form (1). A basis of the complex vector fields on  $M$  is formed by the fields

$$Z_j(\zeta) = \sum_{\nu=1}^n a_{\nu j}(\zeta) \frac{\partial}{\partial z_\nu}, \quad j = 1, \dots, l, \tag{6}$$

if at each point  $\zeta \in M$  the vectors  $Z_j(\zeta)$  are complex-linearly independent and  $Z_j(\varphi_\mu) = 0$  for  $\mu = 1, \dots, k$  (i.e.,  $Z_j(\zeta) \in T_\zeta^c(M)$ ), and a basis of the generic vector fields is given by the fields  $Z_j(\zeta)$  of (6), their complex conjugates  $\bar{Z}_j(\zeta)$ ,  $j = 1, \dots, l$ , and also the fields

$$X_{l+j}(\zeta) = \operatorname{Re} \sum_{\nu=1}^n b_{\nu j}(\zeta) \frac{\partial}{\partial z_\nu}, \quad j = 1, \dots, r - 2l,$$

which belong to  $T_\zeta(M)$  at each point  $\zeta \in M$  and are linearly independent from (6).

In particular, for a real hypersurface  $S = \{z \in \mathbb{C}^n : \varphi(z) = 0\}$  the dimension  $r = 2n - 1$ , the CR-dimension  $l = n - 1$ , and in a neighborhood where  $\frac{\partial \varphi}{\partial z_n}|_S \neq 0$ , a basis of sections of  $\mathfrak{X}(S)$  is given by the fields

$$Z_j = \frac{\partial \varphi}{\partial z_n} \frac{\partial}{\partial z_j} - \frac{\partial \varphi}{\partial z_j} \frac{\partial}{\partial z_n}, \quad \bar{Z}_j = \frac{\partial \varphi}{\partial \bar{z}_n} \frac{\partial}{\partial \bar{z}_j} - \frac{\partial \varphi}{\partial \bar{z}_j} \frac{\partial}{\partial \bar{z}_n}, \tag{7}$$

$$j = 1, \dots, n - 1,$$

$$X_n = \frac{i}{2} \sum_{\nu=1}^n \left( \frac{\partial \varphi}{\partial \bar{z}_\nu} \frac{\partial}{\partial z_\nu} - \frac{\partial \varphi}{\partial z_\nu} \frac{\partial}{\partial \bar{z}_\nu} \right).$$

The last field can be represented in the form  $X_n = \operatorname{Re} T$ , where

$$T = \sum_{\nu=1}^n i \frac{\partial \varphi}{\partial \bar{z}_\nu} \frac{\partial}{\partial z_\nu} \tag{8}$$

is the vector field on  $S$  which at each point  $\zeta \in S$  is directed in  $T_\zeta(S)$  orthogonally to  $T_\zeta^c(S)$  (this is the direction of the vector  $i\bar{\nabla}\varphi$  corresponding to  $T$ ; see subsection 17). The picture becomes particularly intuitive if at a fixed point  $a \in S$  we choose coordinates so that  $\frac{\partial \varphi}{\partial z_\nu} = 0$  for  $\nu = 1, \dots, n - 1$  and  $\frac{\partial \varphi}{\partial z_n} = 1$  at  $a$ . Then at this point  $T_a(S) = \{x_n = 0\}$ ,  $T_a^c(S) = \{z_n = 0\}$ , and the vectors  $Z_j = \frac{\partial}{\partial z_j}$  for  $j = 1, \dots, n - 1$  (a basis of  $T_a^c$ ), and  $X_n = \frac{1}{2} \frac{\partial}{\partial y_n}$ .

As an example of the application of the concepts considered here we give a simple theorem on the local extension of CR-functions from manifolds that are not generating (it was proved by R. WELLS in 1969).

**THEOREM 1.** *Suppose we are given a CR-manifold  $M \subset \mathbb{C}^n$ , for which  $\text{codim}_{\mathbb{R}} M = k$ , and  $\text{dim}_{\mathbb{C}\mathbb{R}} M = n - k'$ , where  $k' < k$ . Then in a sufficiently small neighborhood  $U$  of an arbitrary point  $a \in M$  there is a generating manifold  $\widetilde{M} \supset M \cap U$ ,  $\text{codim}_{\mathbb{R}} \widetilde{M} = k'$ , such that any CR-function  $f$  on  $M \cap U$  extends to a CR-function on  $\widetilde{M}$ .*

◀ Without loss of generality we take  $a = 0$  and assume that in  $U$  the manifold  $M$  is given by the system (1) with the condition (2), and  $\bar{\partial}\varphi_1 \wedge \cdots \wedge \bar{\partial}\varphi_k = 0$ , but  $\bar{\partial}\varphi_1 \wedge \cdots \wedge \bar{\partial}\varphi_{k'} \neq 0$ . Making a  $\mathbb{C}$ -linear change of coordinates of  $\mathbb{C}^n$  if necessary, we may assume that the tangent plane  $T_0(M)$  coincides with the plane of the coordinates  $x_1, \dots, x_{2n-k}$  (we assume that  $z_j = x_j + ix_{n+j}$ ), and we denote the remaining coordinates by  $y_1, \dots, y_k$ . By the implicit function theorem  $M$  can be defined locally by the vector equation  $y = \psi(x)$ , where  $\psi$  is a function of class  $C^1$ . We set  $\tilde{\varphi}_j(x, y) = y_j - \psi_j(x)$ , where  $j = 1, \dots, k$ , and then  $M$  (also locally) is written by the equations  $\tilde{\varphi}_1 = \cdots = \tilde{\varphi}_k = 0$ .

Since  $\text{dim } T_0^{\mathbb{C}}(M) = n - k'$ , among the vectors  $\bar{\nabla}\tilde{\varphi}_j(0)$  there are  $k'$  complex-linearly independent vectors, and we assume that these are the first  $k'$  vectors. Then  $\bar{\partial}\tilde{\varphi}_1 \wedge \cdots \wedge \bar{\partial}\tilde{\varphi}_{k'} \neq 0$  at the point 0, and hence, in some neighborhood, say in  $U$ . We consider the manifold  $\widetilde{M} = \{z \in U: \tilde{\varphi}_1(z) = \cdots = \tilde{\varphi}_{k'}(z) = 0\}$ ; since  $\text{dim}_{\mathbb{C}\mathbb{R}} \widetilde{M} = n - k'$ , where  $k' = \text{codim}_{\mathbb{R}} \widetilde{M}$ , it is a generating manifold (see subsection 17) and it obviously contains  $M \cap U$ .

The manifold  $M$  is stratified by pairwise disjoint manifolds  $M_t = \{\tilde{\varphi}_1 = \cdots = \tilde{\varphi}_{k'} = 0, \tilde{\varphi}_{k'+1} = t_1, \dots, \tilde{\varphi}_k = t_{k-k'}\}$ , where  $t = (t_1, \dots, t_{k-k'})$  is a point belonging to a sufficiently small neighborhood  $0 \in \mathbb{R}^{k-k'}$ . Each  $M_t$  is obtained from  $M$  by parallel transport by some vector  $a_t$  and  $T_{\zeta+a_t}^{\mathbb{C}}(M_t) = T_{\zeta}^{\mathbb{C}}(M)$ ; since the dimension of these spaces is equal to  $n - k' = \text{dim}_{\mathbb{C}\mathbb{R}} \widetilde{M}$ , then at each point  $z \in M_t$  we have  $T_z^{\mathbb{C}}(M_t) = T_z^{\mathbb{C}}(\widetilde{M})$ .

The extension of  $f$  to  $\widetilde{M}$  is given by the condition  $\tilde{f}(\zeta + a_t) = f(\zeta)$ , where  $\zeta \in M$ . Since  $f$  on  $M$  satisfies the tangential Cauchy-Riemann conditions, then  $\bar{Z}_{\zeta}(f) = 0$  for any complex tangent vector  $Z \in T_{\zeta}^{\mathbb{C}}(M)$  and any point  $\zeta \in M$  (see subsection 31). But then for any  $Z \in T_{\zeta+a_t}^{\mathbb{C}}(\widetilde{M})$  we have  $\bar{Z}_{\zeta+a_t}(\tilde{f}) = \bar{Z}_{\zeta}(f) = 0$ , i.e.,  $\tilde{f}$  is a CR-function on  $\widetilde{M}$ . ▶

Thus, for manifolds that are not generating manifolds, the local extension of CR-functions to generating manifolds is accomplished by a simple parallel transport. A significantly more complicated question is that of the extension of CR-functions from generating manifolds. A special case of it—for real hypersurfaces—was considered in subsection 52 (see Theorem 1). Other aspects of this for manifolds of large codimension are discussed in the survey paper by G. M. KHENKIN and E. M. CHIRKA, *Boundary properties of holomorphic functions of several complex variables*, *Sovremennye Problemy Mat.*,

vol. 4, VINITI, Moscow, 1975, pp. 13–141; English transl., J. Soviet Math. 5 (1976), no. 5, 612–687.

We will now go into the concept of the bracket of two vector fields. Let the CR-manifold  $M$  be given as before by the equations (1) with the condition (2), but  $\varphi_j \in C^2(U)$ . If

$$Z = \sum_{\mu=1}^n a_{\mu}(\zeta) \frac{\partial}{\partial z_{\mu}}, \quad Z(\varphi_j) = 0, \quad j = 1, \dots, k, \quad (9)$$

is a complex vector field on  $M$  and  $\bar{Z}$  is its complex conjugate, then the composition

$$\begin{aligned} Z \circ \bar{Z} &= \left( \sum_{\mu=1}^n a_{\mu} \frac{\partial}{\partial z_{\mu}} \right) \left( \sum_{\nu=1}^n \bar{a}_{\nu} \frac{\partial}{\partial \bar{z}_{\nu}} \right) \\ &= \sum_{\nu=1}^n \left( \sum_{\mu=1}^n a_{\mu} \frac{\partial \bar{a}_{\nu}}{\partial z_{\mu}} \right) \frac{\partial}{\partial \bar{z}_{\nu}} + \sum_{\mu, \nu=1}^n a_{\mu} \bar{a}_{\nu} \frac{\partial^2}{\partial z_{\mu} \partial \bar{z}_{\nu}} \end{aligned}$$

will not be a vector field because of the second sum. To remove this, we consider the commutator

$$\begin{aligned} [Z, \bar{Z}] &= Z \circ \bar{Z} - \bar{Z} \circ Z \\ &= \sum_{\nu=1}^n \left( \sum_{\mu=1}^n a_{\mu} \frac{\partial \bar{a}_{\nu}}{\partial z_{\mu}} \right) \frac{\partial}{\partial \bar{z}_{\nu}} - \sum_{\nu=1}^n \left( \sum_{\mu=1}^n \bar{a}_{\mu} \frac{\partial a_{\nu}}{\partial \bar{z}_{\mu}} \right) \frac{\partial}{\partial z_{\nu}}, \end{aligned}$$

which is called the *Poisson bracket* of the fields  $Z$  and  $\bar{Z}$ : upon subtraction the redundant sum is truncated, and a generic vector field is obtained, a section of the bundle  $\mathfrak{X}(M)$ . However, from it it is easy to obtain a real field, i.e., a section of  $T(M)$ —it suffices to replace  $[Z, \bar{Z}]$  by  $i[Z, \bar{Z}]$ ; then the coefficients of  $\frac{\partial}{\partial z_{\nu}}$  and  $\frac{\partial}{\partial \bar{z}_{\nu}}$  will be complex conjugates and in correspondence with what we stated at the beginning of this subsection instead of  $i[Z, \bar{Z}]$  we can consider the field

$$W = - \sum_{\nu=1}^n \left( \sum_{\mu=1}^n i \bar{a}_{\mu} \frac{\partial a_{\nu}}{\partial \bar{z}_{\mu}} \right) \frac{\partial}{\partial z_{\nu}}, \quad (10)$$

for which only  $\operatorname{Re} W(\varphi_j) = 0$  for  $j = 1, \dots, k$ . This field will also be called the Poisson bracket of the vector fields  $Z$  and  $\bar{Z}$ .

For hypersurfaces the Poisson bracket turns out to be related to the Levi form.

**THEOREM 2.** *If  $S = \{z \in U: \varphi(z) = 0\}$  is a real hypersurface of class  $C^2$ ,  $Z: Z(\varphi) = 0$  a complex vector field on  $S$ , and  $\Upsilon$  is a vector field in  $T(S)$  of the form (8), orthogonal to  $T^c(S)$ , then at each point  $\zeta \in S$  the Hermitian*

scalar product

$$(W, T)_\zeta = H_\zeta(\varphi, Z), \tag{11}$$

where  $W$  is the Poisson bracket (10) and  $H$  is the Levi form of the function  $\varphi$ .

◀ If  $W$  is a vector field of the form (10) and  $T$  is of the form (8), then

$$(W, T) = - \sum_{\mu, \nu=1}^n \bar{a}_\nu \frac{\partial a_\mu}{\partial \bar{z}_\nu} \frac{\partial \varphi}{\partial z_\mu} \tag{12}$$

(we have changed the places of the indices  $\mu$  and  $\nu$ ). But from the condition

$$Z(\varphi) = \sum_{\mu=1}^n a_\mu \frac{\partial \varphi}{\partial z_\mu} = 0,$$

which  $Z$  satisfies, we obtain by differentiation<sup>(30)</sup> that

$$\sum_{\mu=1}^n \left( \frac{\partial a_\mu}{\partial \bar{z}_\nu} \frac{\partial \varphi}{\partial z_\mu} + a_\mu \frac{\partial^2 \varphi}{\partial z_\mu \partial \bar{z}_\nu} \right) = 0 \quad \text{for } \nu = 1, \dots, n.$$

Multiplying these equalities by  $\bar{a}_\nu$  and summing, we obtain

$$- \sum_{\mu, \nu=1}^n \bar{a}_\nu \frac{\partial a_\mu}{\partial \bar{z}_\nu} \frac{\partial \varphi}{\partial z_\mu} = \sum_{\mu, \nu=1}^n \frac{\partial^2 \varphi}{\partial z_\mu \partial \bar{z}_\nu} a_\mu \bar{a}_\nu.$$

By the definition of the Levi form (see subsection 37) this is precisely its value on the vector  $Z$ , so that (12) coincides with (11). ▶

REMARK. If the Levi form of the function  $\varphi$  does not vanish on complex tangent vectors  $Z \neq 0$  (for example, if  $S$  is a strictly pseudoconvex surface, see subsection 39), then by Theorem 2 at each point the bracket  $i[Z, \bar{Z}]$

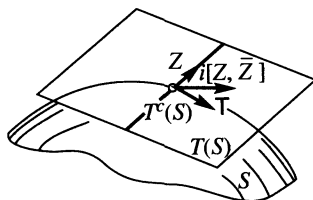

FIGURE 56

<sup>(30)</sup>For the differentiation we assume that the field  $Z$  has been extended in a neighborhood of  $S$  with the validity of the condition  $Z(\varphi) = 0$ . This can be done, for example, as follows: let  $\tilde{Z}$  be an arbitrary  $C^1$ -extension of the field, and  $T$  the field from (8); then the field  $Z = \tilde{Z} - (\tilde{Z}, T)/|\nabla\varphi|^2$  will be the desired one. In fact, the condition  $Z(\varphi) = 0$  is equivalent to  $(Z, T) = 0$  and, obviously, holds in a neighborhood of  $S$ , since  $(T, T) = |\nabla\varphi|^2$ . Moreover,  $\tilde{Z}|_S = Z$  and  $(Z, T) = 0$  there, so that this field coincides with  $Z$  on  $S$ .

(more precisely, the corresponding vector  $W$ ) has nonzero projection onto the vector  $T$ , orthogonal in  $T(S)$  to the complex tangent plane  $T^c(S)$ , and hence, the bracket  $i[Z, \bar{Z}]$  is transversal to  $T^c(S)$  (Figure 56). This remark will be used in the following subsection.

**65. Boundary properties of functions.** Here we consider some applications of the concepts considered in the previous subsection. We start with a result of A. E. TUMANOV,<sup>(31)</sup> in which the structure of vector fields on hypersurfaces is used.

**THEOREM 1.** *Let  $D = \{z \in \mathbb{C}^n: \varphi(z) < 0\}$  be a domain with a boundary  $S$  of class  $C^2$  and let  $E$  be a subset of  $S$  of positive  $(2n - 1)$ -dimensional volume, where the Levi form*

$$H_\zeta(\varphi, Z) \neq 0 \quad \text{for all } \zeta \in E \text{ and } Z \in T_\zeta^c(S), Z \neq 0. \quad (1)$$

*If the function  $f \in C^2(\bar{D})$ , holomorphic in  $D$ , is real on  $E$ , then it is constant.*

◀ Since  $f$  satisfies the tangential Cauchy-Riemann conditions on  $S$ ,  $Z(f) = 0$  for any complex vector field on  $S$ . On the set  $E$  where  $f$  is real, the equality  $\bar{Z}(f) = 0$  also holds, and hence  $[Z, \bar{Z}](f) = 0$  for any  $Z \in T^c(S)$ . But according to the remark at the end of the previous subsection it follows from condition (1) that on  $E$  the bracket  $[Z, \bar{Z}]$  is transversal to  $T^c(S)$ . Therefore on  $E$  the generic tangent vector  $\tilde{Z} \in \mathfrak{T}(S)$  is represented in the form of a sum of vectors from  $T^c$  and  $\bar{T}^c$ , and also a vector that is complex-proportional to the bracket, and hence, for all  $\zeta \in E$  and any  $\tilde{Z} \in \mathfrak{T}_\zeta(S)$  we have  $\tilde{Z}(f) = 0$ . From this it follows that at all  $\zeta \in E$  the derivatives of  $f$  in all the directions on  $T_\zeta(S)$  are equal to 0, i.e., that  $f|_E = \text{const}$ .

In the simplest case when  $E$  contains an open subset of  $S$ , considering the restrictions of  $f$  to the complex lines intersecting this subset and applying the boundary uniqueness theorem for functions of one variable, it is easy to conclude from this that  $f = \text{const}$  in a neighborhood in  $D$  adjoining the subset, and hence, everywhere in  $D$ . This same derivation can be carried out in the general case, when  $\text{meas}_{2n-1} E > 0$ ; a detailed proof can be found in a paper of L. A. AIZENBERG.<sup>(32)</sup> ▶

From Theorem 1 it follows that if  $D \subset \mathbb{C}^n$ ,  $n > 1$ , is a strictly pseudoconvex domain, and the function  $f \in \mathcal{O}(D) \cap C^2(\bar{D})$  is such that  $|f| = c = \text{const}$  on a set  $E \subset \partial D$ ,  $\text{meas}_{2n-1} E > 0$ , then  $f \equiv c$ . (In fact, for  $c = 0$  the assertion follows from the boundary uniqueness theorem mentioned at the end of the proof, and for  $c \neq 0$  Theorem 1 can be applied to the function

<sup>(31)</sup>A. M. TUMANOV, *On boundary values of holomorphic functions of several complex variables*, Uspekhi Mat. Nauk 29 (1974), no. 4, 158–159. (Russian)

<sup>(32)</sup>L. A. AIZENBERG, *Some boundary properties of analytic functions of several complex variables*, Research on Contemporary Problems of the Theory of Functions of a Complex Variable, Fizmatgiz, Moscow, 1961, pp. 239–241. (Russian)



$g = \ln|f|$ , which is holomorphic in the intersection of  $D$  and a neighborhood of  $E$ .) For  $n = 1$  this result is false: in the case of the unit disc  $U \subset \mathbb{C}$  a counterexample is given by finite products of linear-fractional functions—automorphisms of  $U$ . For  $n > 1$  the condition of strict pseudoconvexity, which ensures (1), is essential, since the result is also false without it: the nonconstant function  $f(\zeta) = z_1$  is equal to one in modulus on the open subset  $\{|z_1| = 1, |z_2| < 1\}$  of the boundary of the bidisc  $U^2$ .

In the theory of boundary properties of functions of one variable so-called *inner functions* in the disc  $U$  play an important role. These are nonconstant bounded holomorphic functions whose modulus tends to 1 almost everywhere on  $S = \partial U$  as  $S$  is approached along radii. Tumanov's theorem shows that for  $n \geq 1$  there do not exist inner functions that are  $C^2$  in the closure of strictly pseudoconvex domains. The condition of being  $C^2$  was weakened by a number of authors. For example, A. SADULLAEV proved in 1976 that every function that is holomorphic in a strictly pseudoconvex domain  $D \subset \mathbb{C}^n$ ,  $n > 1$ , and having radial limits equal to one in modulus at all points of some nonempty open subset  $E \subset \partial D$ , is constant.

A conjecture arose, called the inner function conjecture, according to which there are no inner functions in strictly pseudoconvex domains of  $\mathbb{C}^n$ ,  $n > 1$ . However, in 1982, the Leningrad mathematician A. B. ALEKSANDROV proved<sup>(33)</sup> that inner functions exist even in balls in  $\mathbb{C}^n$  for any  $n$ .

The following properties reflect the specifics of the structure of boundaries of domains of  $\mathbb{C}^n$  for  $n > 1$ . Among all the directions on such boundaries the complex tangent directions and the direction  $T$  orthogonal to the complex tangent plane are distinguished. It turns out that the boundary behavior of holomorphic functions in directions of different types is essentially different.

As an example, in which this difference appears, we give a result obtained by E. M. CHIRKA.<sup>(34)</sup> In order to state it, we denote by  $\nu_\zeta = \overline{\nabla_\zeta \phi} / |\nabla_\zeta \phi|$  the unit normal vector to  $\partial D$  at the point  $\zeta$ , by  $\delta_\zeta(z) = |\operatorname{Re}(z - \zeta, \nu_\zeta)|$  the distance of the point  $z$  to the real tangent plane  $T_\zeta(\partial D)$ , and for fixed  $\alpha$ ,  $k > 0$  and  $\varepsilon$ ,  $0 < \varepsilon < 1$ , we consider the domain

$$K_\zeta = \{z \in D: |(z - \zeta, \nu_\zeta)| < (1 + \alpha)\delta_\zeta(z), |z - \zeta|^2 < k\delta_\zeta^{1+\varepsilon}(z)\}. \quad (2)$$

In the direction  $T_\zeta^c$  this domain is tangent to  $\partial D$ , and in the direction  $T$  the domain forms an acute angle with it (Figure 57). In fact, if  $z$  belongs to the hyperplane  $I$  on Figure 57, passing through  $\nu_\zeta$  and  $T_\zeta^c$ , then  $|(z - \zeta, \nu_\zeta)| = \delta_\zeta(z)$ , and the first condition in the definition of  $K_\zeta$  holds automatically, while the second gives  $\xi^2 + \eta^2 < k\eta^{1+\varepsilon}$  (the meaning of  $\xi$  and  $\eta$  is clear from the figure); the intersection  $\partial K_\zeta \cap I$  is the surface

<sup>(33)</sup>A. B. ALEKSANDROV, *The existence of inner functions in the ball*, Mat. Sb. **118** (160) (1982), no. 2, 147–163; English transl., Math. USSR-Sb. **46** (1983), 143–159.

<sup>(34)</sup>E. M. CHIRKA, *The theorems of Lindelöf and Fatou in  $\mathbb{C}^n$* , Mat. Sb. **92** (134) (1973), no. 4, 622–644; English transl., Math. USSR-Sb. **21** (1973), 619–639.

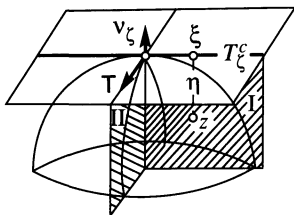

FIGURE 57

$\xi^2 + \eta^2 = k\eta^{1+\varepsilon}$ , tangent to  $T_\zeta^c$  at the point  $\zeta$ . However, if  $z$  belongs to the hyperplane  $\Pi$ , passing through  $\nu_\zeta$  and  $T_\zeta$ , then  $|(z - \zeta, \nu_\zeta)| = |z - \zeta|$ ; therefore for  $z$  sufficiently close to  $\zeta$ , the second condition in the definition of  $K_\zeta$  follows from the first, and the first gives  $\xi^2 + \eta^2 < (1 + \alpha)^2 \eta^2$ ; the intersection  $\partial K_\zeta \cap \Pi$  close to  $\zeta$  is the pair of intersecting planes  $\xi = \pm \sqrt{2\alpha + \alpha^2} \eta$ .

In the theory of functions of one complex variable there is a theorem which states that a function that is bounded and holomorphic in a domain  $D$ , and having a limit as  $z \rightarrow \zeta \in \partial D$  in the direction of the normal  $\nu_\zeta$ , tends to the same limit as  $z \rightarrow \zeta$  in any direction not tangent to  $\partial D$  (LINDELÖF'S theorem). As a simple example shows, the limits in the tangent directions must be excluded: the function  $f(z) = e^{-1/z}$  is holomorphic and bounded in the disc  $\{|z - 1| < 1\}$ , and at the boundary point  $z = 0$  its limit along nontangential paths is equal to zero, while its limit along tangential paths does not exist. For  $n > 1$  the situation is changed, since limits are also admitted along some tangential directions, namely, complex tangential directions. The following result holds:

**THEOREM 2 (E. M. CHIRKA).** *If the function  $f$  is holomorphic and bounded in a domain  $D \subset \mathbb{C}^n$  and if it has a limit  $A$  as  $z \rightarrow \zeta \in \partial D$  in the direction of the real normal (i.e., the line  $z = \zeta + t\nu_\zeta$ ,  $t \in \mathbb{R}$ ), then it has the same limit as  $z \rightarrow \zeta$  over points  $z \in K_\zeta \cap D$ , where  $K_\zeta$  is the domain defined in (2).*

◀ For simplicity we carry out the proof for the case when the domain  $D$  is the unit ball  $B$  (for the general case see Chirka's paper cited above). Without loss of generality we assume that  $\zeta = (0, 1)$ ; since here  $\varphi(z) = |z|^2 - 1$ , then  $\nabla\varphi = \bar{z}$  and  $\nu_\zeta = \zeta$ . The complex tangent plane to  $\partial B$  at the point  $\zeta$  is denoted by  $T^c$  (for our choice of  $\zeta$  it is defined by the equation  $z_n = 1$ ), and by  $T_\lambda^c = \{(z, 1 - \lambda): z \in \mathbb{C}^{n-1}\}$  a plane parallel to  $T^c$ .

We clarify the form of the intersection  $B_\lambda = T_\lambda^c \cap B$ . For this we pass a complex normal  $N^c = \{(0, t): t \in \mathbb{C}\}$  to  $\partial B$  through  $\zeta$ ; its point of intersection with  $T_\lambda^c$  will be  $c_\lambda = (0, 1 - \lambda)$ . The intersection  $T_\lambda^c \cap \partial B$  is defined by the conditions  $|z|^2 + |1 - \lambda|^2 = 1$ ,  $z_n = 1 - \lambda$ , the first of which

is rewritten in the form  $|z'|^2 = 2\operatorname{Re} \lambda - |\lambda|^2$ . Thus,  $B_\lambda$  is a ball in the plane  $T_\lambda^c$  with center  $c_\lambda$  and radius  $R_\lambda = \sqrt{2\operatorname{Re} \lambda - |\lambda|^2}$ :

$$B_\lambda = \{z \in T_\lambda^c : |z - c_\lambda| < R_\lambda\}. \tag{3}$$

Now we clarify the form of the intersection  $B'_\lambda = T_\lambda^c \cap K_\zeta$ . The inequalities defining  $K_\zeta$  are as follows in our case:  $|z_n - 1| < (1 + \alpha)|\operatorname{Re}(z_n - 1)|$ ,  $|z'|^2 + |z_n - 1|^2 < k|\operatorname{Re}(z_n - 1)|^{1+\varepsilon}$ . Since  $z_n - 1 = -\lambda$  on  $T_\lambda^c$ , then  $B'_\lambda$  is defined by the inequalities  $|\lambda| < (1 + \alpha)|\operatorname{Re} \lambda|$ ,  $|z'|^2 < k|\operatorname{Re} \lambda|^{1+\varepsilon} - |\lambda|^2$ , i.e., is also a ball in the plane  $T_\lambda^c$  with the same center  $c_\lambda$  and radius  $R'_\lambda = \sqrt{k|\operatorname{Re} \lambda|^{1+\varepsilon} - |\lambda|^2}$ :

$$B'_\lambda = \{z \in T_\lambda^c : |z - c_\lambda| < R'_\lambda\}, \quad |\lambda| < (1 + \alpha)|\operatorname{Re} \lambda|. \tag{4}$$

The ratio of the squares of the radii of the balls  $B'_\lambda$  and  $B_\lambda$  is

$$\left(\frac{R'_\lambda}{R_\lambda}\right)^2 = \frac{k|\operatorname{Re} \lambda|^{1+\varepsilon} - |\lambda|^2}{2\operatorname{Re} \lambda - |\lambda|^2} \leq \frac{k|\operatorname{Re} \lambda|^\varepsilon}{2 - |\lambda| |\lambda| / \operatorname{Re} \lambda},$$

and since we have  $|\lambda|/\operatorname{Re} \lambda < 1 + \alpha$ , then  $R'_\lambda/R_\lambda \rightarrow 0$  as  $\lambda \rightarrow 0$ .

Since by hypothesis  $f$  is bounded in  $B$ , let  $|f(z)| \leq M$ ; then by the Schwarz lemma of subsection 9 for all  $z \in B_\lambda$  we have  $|f(z) - f(c_\lambda)| \leq \frac{2M}{R_\lambda}|z - c_\lambda|$ , and if  $z \in B'_\lambda$ , then  $|f(z) - f(c_\lambda)| \leq 2MR'_\lambda/R_\lambda$ . The point  $c_\lambda$  belongs to the complex normal  $N_\zeta^c$  and tends to  $\zeta$  as  $\lambda \rightarrow 0$ . By the Lindelöf theorem for one variable, applied to the disc  $N_\zeta^c \cap B$ , from the existence of a limit of  $f(z)$  as  $z \rightarrow \zeta$  along a real normal and from the condition  $|\lambda| < (1 + \alpha)|\operatorname{Re} \lambda|$  it follows that the limit  $\lim_{\lambda \rightarrow 0} f(c_\lambda) = A$  also exists. Since  $R'_\lambda/R_\lambda \rightarrow 0$ , then we conclude from the last inequality that the same limit also exists for  $f(z)$  as  $z \rightarrow \zeta$ ,  $z \in K_\zeta$ . ►

We remark that for arbitrary tangent directions the assertion of the theorem becomes false: the function  $f(z) = z_2^2/(1 - z_1)$  is holomorphic in the unit ball  $B \subset \mathbb{C}^2$  and is bounded there, since  $|f(z)| \leq (1 - |z_1|)^2/(1 - |z_1|) \leq 2$ , but as  $z$  tends to the boundary point  $\zeta = (1, 0)$  it has different limits along the surfaces  $1 - z_1 = \lambda z_2^2$ , tangent to  $\partial B$  at the point  $\zeta$ . The theorem is also false for domains with nonsmooth boundaries: the function  $f(z) = z_1/z_2$  is holomorphic and bounded in the domain  $\{z \in \mathbb{C}^2 : |z_1| < |z_2|\}$ , but its limits as  $z \rightarrow (0, 0)$  along different lines  $\{z_1 = \lambda z_2\}$  are different.

It is interesting to notice that the boundedness of the function, which is required in Chirka's theorem, is ensured automatically in some cases by lesser requirements. The first result of this kind was obtained in 1982 by YU. N. DROZHSHINOV and B. I. ZAV'YALOV, who proved that a holomorphic function in a domain  $D \subset \mathbb{C}^n$  is bounded under a nontangential approach to the boundary if it is bounded on some real  $(n + 1)$ -dimensional

manifold intersecting the boundary. Recently this result was strengthened by YU. V. KHURUMOV:<sup>(35)</sup>

**THEOREM.** *If the function  $f$  is holomorphic in a domain  $D \subset \mathbb{C}^n$ ,  $n > 1$ , with boundary of class  $C^1$ , and if for a point  $\zeta \in \partial D$  there is an  $n$ -dimensional generating manifold  $M \subset D \cup \{\zeta\}$  of class  $C^2$ , then it follows from the boundedness of  $f$  on  $M \setminus \{\zeta\}$  that it is bounded in the intersection of any nontangential cone with vertex  $\zeta$  with a neighborhood of this point.*

We deduce from this that under the hypotheses of this theorem the Lindelöf effect is valid: if the limit exists along some nontangential path in  $D$  leading to  $\zeta$ , then the same limit is attained along any nontangential path leading to this point. The result is false for  $n = 1$ : the function  $f(z) = e^{-1/z^4}$  is bounded on the intersection of the domain  $D = \{z \in \mathbb{C}: x < y^2\}$  with  $M = \{y = 0\}$ , tends to 0 as  $z \rightarrow 0$  along the real axis, but is not bounded as  $z = 0$  is approached along the ray  $\arg z = 3\pi/4$ .

If the complex tangent directions play, so to speak, a positive role (they can be touched approaching the boundary, preserving the normal limit value of functions) in the theorem we have proved, then in some questions they can play a negative one. We illustrate this by an example due to E. A. POLETSKIĬ.

**EXAMPLE.** The complex line  $\{z_1^2 + z_2^2 = 1\}$  in  $\mathbb{C}^2$  is tangent to the sphere  $\partial B = \{|z_1|^2 + |z_2|^2 = 1\}$  along a curve  $\gamma = \{z \in \partial B: \operatorname{Im} z_1 = \operatorname{Im} z_2 = 0\}$  of real dimension 1 (this is the unit circle  $x_1^2 + x_2^2 = 1$  in the real space  $\mathbb{C}^2$ ).

At points  $z \in \partial B$  a complex tangent direction is determined by a vector  $u = \bar{z}_2 \frac{\partial}{\partial z_1} - \bar{z}_1 \frac{\partial}{\partial z_2}$ , and since  $z_1$  and  $z_2$  are real on  $\gamma$ , then at points of  $\gamma$  this direction coincides with the direction  $x_2 \frac{\partial}{\partial x_1} - x_1 \frac{\partial}{\partial x_2}$ , tangent to  $\gamma$ . Thus,  $\gamma$  has a complex tangent direction at each point of it.

The mapping  $f: B \rightarrow \mathbb{C}^2$  with coordinates

$$f_1(z) = z_1^2 + z_2^2, \quad f_2(z) = z_1(z_1^2 + z_2^2 - 1) \quad (5)$$

and with Jacobian  $J_f(z) = 2z_2(1 - z_1^2 - z_2^2)$  is locally biholomorphic in  $B \setminus \{z_2 = 0\}$ . Among all the directions in particular, it is biholomorphic in some strictly pseudoconvex domain  $D \subset B$ , part of whose boundary is a piece of the sphere  $\partial B$  containing a piece of the curve  $\gamma$ . The mapping  $f$  extends continuously to  $\bar{D}$  and contracts to the point  $(1, 0)$  the piece of the curve  $\gamma$  belonging to  $\partial D$ . Of course, the image  $f(D) = G$  cannot be a strictly pseudoconvex domain, since in this case the inverse  $f^{-1}$  by Theorem 1 of subsection 63 would be continuous in  $\bar{G}$  and could not expand the point  $(1, 0)$  to the curve  $\gamma$ .

It is clear that boundaries of domains that are not strictly pseudoconvex can contain complex lines, which contract to a point by biholomorphic mappings. This example shows that, also on the boundaries of strictly pseudoconvex domains, curves along complex tangent directions can possess the same negative property. Thus, the boundary properties of biholomorphic mappings of higher-dimensional domains are different from the properties of conformal mappings of domains of the plane.

<sup>(35)</sup>YU. V. KHURUMOV, *On Lindelöf's theorem in  $\mathbb{C}^n$* , Dokl. Akad. Nauk SSSR 273 (1983), no. 6, 1325–1328; English transl., Soviet Math. Dokl. 28 (1983), 806–809.

**66. Uniqueness theorems and propositions.** We begin with a definition: suppose we are given a domain  $D \subset \mathbb{C}^n$ ; a set  $M \subset \bar{D}$  is called a *set of uniqueness* if, for any function  $f$  that is holomorphic in  $D$  and continuous in  $D \cup M$ , the condition  $f|_M = 0$  implies that  $f \equiv 0$ . The condition  $f \in C(D \cup M)$  is, of course, essential only when  $M \cap \partial D \neq \emptyset$ .

The simplest examples of intrinsic sets of uniqueness are nonempty open subsets of domains or their intersections with a real subspace (subsection 5). These examples are generalized by the following:

**THEOREM 1.** *Any generating manifold  $M \subset D$  is a set of uniqueness.*

◀ Since the zeros of a holomorphic function that is not identically zero form an analytic set of codimension 1, it suffices to prove that  $M$  cannot belong to such sets. Suppose the contrary, that  $M \subset A$ ,  $\text{codim } A = 1$ ; if  $z \in M$  is a regular point of  $A$ , then  $T_z(M) \subset T_z(A)$ , and the latter is a complex hyperplane. But this cannot be true for generating manifolds (see subsection 17), and, hence,  $M$  must completely belong to the set  $A^c$  of critical points of  $A$ . The set  $A^c$  is also analytic, but of codimension  $k \geq 2$ , and, repeating the previous argument, we find that  $M$  must belong to the set of critical points of the set  $A^c$ , which is an analytic set of codimension  $k_1 \geq 3$ . After a finite number of repetitions of this kind of argument, we arrive at a contradiction: we find that  $M$  must belong to a set whose real dimension is less than  $\dim_{\mathbb{R}} M$ . ▶

Passing to boundary sets, we begin with an explanation of how one is to understand the tangential Cauchy-Riemann conditions on the boundary of a domain, if the function is only continuous there. We consider the more general situation of an arbitrary CR-manifold  $M \subset \mathbb{C}^n$ ,  $\dim_{\mathbb{R}} M = r$ ,  $\dim_{\text{CR}} M = l > 0$ . Obviously,  $2l \leq r$ , and if  $2l = r$ , then  $T_{\zeta}^c(M) = T_{\zeta}^{\text{CR}}(M)$  for all points  $\zeta \in M$ , and by the Levi-Civita theorem from subsection 17  $M$  is a complex manifold.

As was shown in subsection 64, the generic vector fields on  $M$  have the following structure: there exist  $l$  complex basis vector fields  $Z_j$ ,  $l$  anticomplex ones  $\bar{Z}_j$ , and, if  $2l < r$ , there are still  $r - 2l$  real basis fields  $X_j$ . In correspondence with this, the restriction to  $T_{\zeta}(M)$  of a differential form of bidegree  $(l, m)$ , where  $m = r - l \geq l$ , has, at each point of  $M$ ,  $l$  differentials in the directions of  $Z_j$ ,  $l$  in the directions of  $\bar{Z}_j$ , and  $m - l$  in the directions of  $X_j$ . Also the restriction of a form of bidegree  $(l, m - 1)$  is a sum of forms, in each of which one differential in the directions  $\bar{Z}_j$  is omitted while the differentials in the remaining directions are present.

We denote by  $\mathcal{D}^{p,q}(M)$  the set of differential forms of bidegree  $(p, q)$  with coefficients that are  $C^\infty$  in a neighborhood of  $M$ . Then for any CR-function

$$\bar{\partial}f \wedge \alpha|_M = 0 \quad \text{for any } \alpha \in \mathcal{D}^{(l, m-1)}. \tag{1}$$

In fact, by what we said above, since  $\alpha|_M$  consists of terms that contain differentials of all the basis directions except for  $\bar{Z}_j$ , then in the product of  $\bar{\partial}f$  with this form we need to take into account the derivatives of  $f$  only in the omitted directions. But the tangential Cauchy-Riemann conditions on  $M$  also mean that  $\tilde{Z}_j(f) = 0$  for all  $j = 1, \dots, l$  (see subsection 31), and therefore (1) holds.

Conversely, if condition (1) holds, then since the form  $\alpha$  is arbitrary we can conclude that  $\tilde{Z}_j(f) = 0$  for all  $j = 1, \dots, l$ , i.e., that  $f$  is a CR-function on  $M$ . Therefore (1) is one of the forms of the tangential Cauchy-Riemann equations. It is obvious that under this condition  $\mathcal{D}^{(l, m-1)}(M)$  can be replaced by the set  $\mathcal{D}_0^{(l, m-1)}(M)$  of all COMPACTLY SUPPORTED forms from  $\mathcal{D}^{(l, m-1)}(M)$ , i.e., forms whose coefficients are identically equal to 0 in a neighborhood of the boundary  $\partial M$  (a neighborhood of its own for each form).

Using ideas of the theory of distributions, we can modify condition (1) so that it can be applied to arbitrary continuous (and even only locally integrable along  $M$ ) functions. For this, restricting ourselves first to functions  $f \in C^1(M)$ , we notice that  $\partial(f\alpha)|_M = 0$  for any  $\alpha \in \mathcal{D}^{(l, m-1)}(M)$ , since  $f\alpha|_M$  contains all the differentials in the directions  $Z_j$ . On  $M$  therefore  $d(f\alpha) = \bar{\partial}(f\alpha) = \bar{\partial}f \wedge \alpha + f\bar{\partial}\alpha$ , and by Stokes's theorem

$$\int_M \bar{\partial}f \wedge \alpha = \int_{\partial M} f\alpha - \int_M f\bar{\partial}\alpha = - \int_M f\bar{\partial}\alpha,$$

if  $\alpha \in \mathcal{D}_0^{l, m-1}(M)$ , i.e.,  $\alpha = 0$  on the boundary of  $M$ .

On this basis we also say that  $f$  satisfies the *weak Cauchy-Riemann conditions* on  $M$  if it is locally integrable on  $M$  and

$$\int_M f\bar{\partial}\alpha = 0 \quad \text{for any } \alpha \in \mathcal{D}_0^{l, m-1}(M). \quad (2)$$

Returning to boundary sets of uniqueness, we recall that any  $(2n-1)$ -dimensional submanifold  $M$  of the boundary of a domain  $D \subset \mathbb{C}^n$  is such a set (this is proved by restricting the function to the complex lines intersecting  $M$ , as in subsection 65). Among the submanifolds of  $\partial D$  of smaller dimension some are sets of uniqueness, some are not (the skeleton of the unit bidisc  $U^2$  is a set of uniqueness, but  $\{z \in \partial U^2 : z_1 = 1\}$  is not, although both sets are manifolds of real dimension 2). The following boundary uniqueness theorem holds.

**THEOREM 2.** *Let  $D \subset \mathbb{C}^n$  be a domain with a boundary of class  $C^2$ , and  $M$  a submanifold of  $\partial D$  of the same smoothness. If  $M$  is a generating submanifold, then it is a set of uniqueness.*

This theorem was proved by S. I. PINCHUK in 1974; we shall forgo its proof,<sup>(36)</sup> indicating only that it is based on the fact that to  $M$  we can glue holomorphic discs lying in the domain, and from the discs we construct a generating manifold  $\overline{M} \subset D$ , on which the function is equal to zero; then use Theorem 1.

\* 1. Prove that a  $C^1$ -manifold in  $\mathbb{C}^n$  of real codimension 2, which is not generating at any point, is a complex hypersurface. [HINT: use the Levi-Civita theorem from subsection 17.]

2. Let  $D \subset \mathbb{C}^n$  be a domain with a  $C^2$  boundary, which does not contain complex hypersurfaces (for example,  $D$  is strictly pseudoconvex). Prove that any  $C^2$ -submanifold  $M \subset \partial D$ ,  $\dim_{\mathbb{R}} M = 2n - 2$ , is a set of uniqueness. [HINT: use 1. and Theorem 2.] \*

The boundary uniqueness theorem also generalizes to holomorphic mappings. Let  $D \subset \mathbb{C}^n$  be a domain with a smooth boundary,  $E \subset \partial D$  a generating manifold, and  $f: \overline{D} \rightarrow \mathbb{C}^m$  a mapping that is holomorphic in  $D$  and continuous in  $\overline{D}$ . If  $M = f(E)$  is a thin set (in the sense that there exists a plurisubharmonic function  $u \not\equiv -\infty$  in a neighborhood of  $M$ , and such that  $u|_M \equiv -\infty$ ), then  $f$  is a degenerate mapping, i.e.,  $f(D)$  does not contain interior points.<sup>(37)</sup>

In conclusion we shall dwell on a generalization of the important embedded edge theorem also obtained by PINCHUK.<sup>(38)</sup> This theorem was proved in 1956 by N. N. BOGOLYUBOV and has found many important applications in analysis and mathematical physics.

We shall state Pinchuk's result in a simplified form. In a domain  $D \subset \mathbb{C}^n$  suppose we are given  $n$  real functions  $\varphi_j \in C^2(D)$  such that on the set

$$M = \{z \in D : \varphi_1(z) = \dots = \varphi_n(z) = 0\}, \quad (3)$$

which is assumed to be nonempty,  $d\varphi_1 \wedge \dots \wedge d\varphi_n \neq 0$ ; this means that the  $S_j = \{z \in D : \varphi_j(z) = 0\}$  intersect in general position and their intersection  $M$  is a manifold of real dimension  $n$ .

**THEOREM 3.** *If  $M$  is a generating manifold and the functions  $f^+$  and  $f^-$ , holomorphic respectively in the domains*

$$\begin{aligned} D^+ &= \{z \in D : \varphi_1(z) > 0, \dots, \varphi_n(z) > 0\}, \\ D^- &= \{z \in D : \varphi_1(z) < 0, \dots, \varphi_n(z) < 0\}, \end{aligned} \quad (4)$$

<sup>(36)</sup>S. I. PINCHUK, *A boundary uniqueness theorem for holomorphic functions of several variables*, Mat. Zametki 15 (1974), 205–212; English transl., Math. Notes 15 (1974), 116–120. Another proof of this theorem, based on other ideas, can be found in a paper by R. A. AIRAPETYAN and G. M. KHENKIN, *Analytic continuation of CR-functions through the "edge of the wedge"*, Dokl. Akad. Nauk SSSR 259 (1981), no. 4, 777–781; English transl., Soviet Math. Dokl. 24 (1981), 128–132.

<sup>(37)</sup>See the paper by PINCHUK cited in the previous footnote. See also A. SADULLAEV, *A boundary uniqueness theorem in  $\mathbb{C}^n$* , Mat. Sb. 101 (143) (1976), no. 4, 568–583; English transl., Math. USSR-Sb. 30 (1976), 501–514.

<sup>(38)</sup>S. I. PINCHUK, *Bogolyubov's "edge-of-the-wedge" theorem for generating manifolds*, Mat. Sb. 94 (136) (1974), no. 3, 468–482; English transl., Math. USSR-Sb. 23 (1974), 441–455.

extend continuously to  $M$ , and if their values coincide on  $M: f^+|_M = f^-|_M$ , then  $f^+$  and  $f^-$  extend to a function  $f$  that is holomorphic in a neighborhood of  $M$ .

◀ We restrict ourselves to the case  $n = 2$  and write  $U_j = \{z \in D: \varphi_j(z) > 0\}$ ,  $U_{-j} = \{z \in D: \varphi_j(z) < 0\}$ ,  $j = 1, 2$ ; we assume additionally that  $f^\pm$  extends to  $\overline{D^\pm}$  to a function of class  $C^1$ . The domains  $U_{\pm 1}$ ,  $U_{\pm 2}$  form an open covering of  $D \setminus M$ , and we set  $h_{12} = f^+$ ,  $h_{-1-2} = -f^-$ ,  $h_{-12} = h_{21} = 0$ . Since  $U_{12} = U_1 \cap U_2 = D^+$ ,  $U_{-1-2} = U_{-1} \cap U_{-2} = D^-$  and there are no triple intersections in our case (Figure 58), then  $\{h_{\alpha\beta}\}$ ,  $\alpha, \beta = \pm 1, \pm 2$ , is a holomorphic cocycle (see subsection 44). Let us assume first that the corresponding first Cousin problem is solvable, i.e., there exist functions  $h_\alpha \in \mathcal{O}(U_\alpha)$  such that  $h_{\alpha\beta} = h_\beta - h_\alpha$  or in more detail

$$\begin{aligned} f^+ = h_{12} = h_2 - h_1, & \quad f^- = -h_{-1-2} = h_{-1} - h_{-2}, \\ 0 = h_{-21} = h_1 - h_{-2}, & \quad 0 = h_{-12} = h_2 - h_{-1}. \end{aligned} \tag{5}$$

We conclude from the last two equations that the functions

$$g_1 = \begin{cases} h_1 & \text{in } U_1, \\ h_{-2} & \text{in } U_{-2}, \end{cases} \quad g_2 = \begin{cases} h_2 & \text{in } U_2, \\ h_{-1} & \text{in } U_{-1} \end{cases} \tag{6}$$

are holomorphic in the unions  $U_1 \cup U_{-2}$  and  $U_2 \cup U_{-1}$  respectively. Since the intersection  $\partial U_1 \cap \partial U_{-2} = \partial U_2 \cap \partial U_{-1} = M$  by hypothesis is a generating manifold of real codimension 2, then it cannot be a complex manifold (see the exercise preceding the statement of this theorem). By the theorem on the embedded edge from subsection 42 it follows from this that  $g_1$  and  $g_2$  extend holomorphically into a neighborhood of  $M$ , say, respectively into the domains that are denoted by  $G_1$  and  $G_2$  in Figure 59 on the next page. But then the function  $g_2 - g_1$  is holomorphic in the intersection  $G_1 \cap G_2$ , which contains a neighborhood of  $M$ , and, as we see from (5) and (6), this function is equal to  $f^+$  in  $U_{12} = D^+$  and is equal to  $f^-$  in  $U_{-1-2} = D^-$ . It thus gives the desired holomorphic extension of  $f$ .

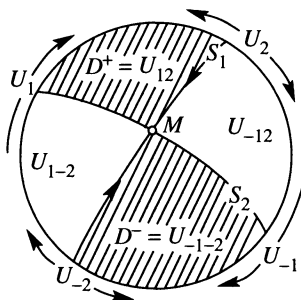

FIGURE 58



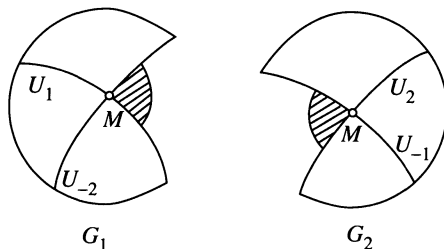

FIGURE 59

It remains to prove that the holomorphic cocycle  $\{h_{\alpha\beta}\}$  is a coboundary, i.e., that it is solvable in holomorphic functions (see subsection 44). We shall carry out this proof according to the same scheme as in Chapter IV, only instead of smooth functions we have to work with distributions here.<sup>(39)</sup> First of all we remark that the cocycle  $\{h_{\alpha\beta}\}$  is solvable in piecewise-holomorphic functions: we can set

$$f_2 = \begin{cases} h_{12} = f^+ & \text{in } U_{12}, \\ 0 & \text{in } U_{-12}, \end{cases} \quad f_{-2} = \begin{cases} h_{-1-2} = -f^- & \text{in } U_{-1-2}, \\ 0 & \text{in } U_{1-2}, \end{cases} \quad (7)$$

and the remaining  $f_\alpha = 0$ —then  $h_{12} = f_2 - f_1$ ,  $h_{1-2} = f_{-2} - f_1$ , etc. The amount these function deviate from holomorphic functions is determined by their derivatives with respect to  $\bar{z}_\nu$ , which must be understood in the sense of distributions. For example, if  $\psi \in C_0^\infty(U_2)$  is a test function, that is, a function of class  $C^\infty$  with support that has compact closure in  $U_2$ , then  $\partial f_2 / \partial \bar{z}_\nu$  is understood to be the functional

$$\begin{aligned} \left\langle \frac{\partial f_2}{\partial \bar{z}_\nu}, \psi \right\rangle &= - \left\langle f_2, \frac{\partial \psi}{\partial \bar{z}_\nu} \right\rangle = \frac{1}{4} \int_{U_{12}} h_{12} \frac{\partial \psi}{\partial \bar{z}_\nu} dz \wedge d\bar{z} \\ &= - \frac{(-1)^\nu}{4} \int_{U_{12}} \frac{\partial h_{12} \psi}{\partial \bar{z}_\nu} d\bar{z}_\nu \wedge dz \wedge d\bar{z}_j, \end{aligned}$$

where  $\nu, j = 1, 2$  and  $j \neq \nu$  (we already know that in  $\mathbb{C}^2$  the real volume element is  $(\frac{i}{2})^2 dz \wedge d\bar{z} = -\frac{1}{4} dz \wedge d\bar{z}$ ), or

$$\begin{aligned} \left\langle \frac{\partial f_2}{\partial \bar{z}_\nu}, \psi \right\rangle &= - \frac{(-1)^\nu}{4} \int_{U_{12}} d(h_{12} \psi) \wedge dz \wedge d\bar{z}_j \\ &= - \frac{(-1)^\nu}{4} \int_{S_1 \cap U_2} h_{12} \psi dz \wedge d\bar{z}_j \end{aligned} \quad (8)$$

(we have used Stokes's formula<sup>(40)</sup> and have taken into account that  $\psi = 0$  in a neighborhood of  $\partial U_2$ ).

<sup>(39)</sup>For more about the results from the theory of distributions that are used here see the book by Hörmander cited at the end of subsection 41.

<sup>(40)</sup>This formula can be applied because of our additional assumption on the functions  $f^\pm$ .

As we ought to expect, the support of  $\partial f_2/\partial \bar{z}_\nu$  is concentrated on  $S_1 \cap U_2$ . The distribution  $\partial f_{-2}/\partial \bar{z}_\nu$  is computed analogously; its support is concentrated on  $S_1 \cap U_{-2}$ , but the orientation of  $S_1$  here is the opposite of the preceding one:

$$\left\langle \frac{\partial f_{-2}}{\partial \bar{z}_\nu}, \psi \right\rangle = \frac{(-1)^\nu}{4} \int_{S_1 \cap U_{-2}} h_{-1-2} \psi dz \wedge d\bar{z}_j \quad (9)$$

(see Figure 58). Since the intersection  $S_1 \cap \bar{U}_2$  and  $S_1 \cap \bar{U}_{-2}$  coincides with  $M$ , and by hypothesis on  $M$  we have  $h_{12} = f^+ = f^- = -h_{-1-2}$ , then formulas (8) and (9) can be combined into a single formula: for any function  $\psi \in C_0^\infty(D)$

$$\langle p_\nu, \psi \rangle = -\frac{(-1)^\nu}{4} \int_{S_1} h \psi dz \wedge d\bar{z}_j, \quad (10)$$

$$h = \begin{cases} h_{12} & \text{on } S_1 \cap U_2, \\ -h_{-1-2} & \text{on } S_1 \cap U_{-2}, \end{cases}$$

where the restrictions of  $p_\nu$  to  $U_{\pm 2}$  coincide respectively with the distributional derivatives  $\partial f_{\pm 2}/\partial \bar{z}_\nu$ .

Thus, in  $D$  the differential form  $\omega = p_1 d\bar{z}_1 + p_2 d\bar{z}_2$  is globally defined; it has distributional coefficients whose supports are concentrated on  $S_1$ . We shall show that it is closed, i.e., that  $\partial p_1/\partial \bar{z}_2 - \partial p_2/\partial \bar{z}_1 = q$  is equal to zero in the sense of distributions. In fact, for any  $\psi \in C_0^\infty(D)$  we have

$$\begin{aligned} \langle q, \psi \rangle &= -\frac{1}{4} \int_D \left( \frac{\partial p_1}{\partial \bar{z}_2} - \frac{\partial p_2}{\partial \bar{z}_1} \right) \psi dz \wedge d\bar{z} \\ &= \frac{1}{4} \int_D \left( p_1 \frac{\partial \psi}{\partial \bar{z}_2} - p_2 \frac{\partial \psi}{\partial \bar{z}_1} \right) dz \wedge d\bar{z} \\ &= \left\langle p_2, \frac{\partial \psi}{\partial \bar{z}_1} \right\rangle - \left\langle p_1, \frac{\partial \psi}{\partial \bar{z}_2} \right\rangle, \end{aligned}$$

and since  $\partial \psi/\partial \bar{z}_\nu \in C_0^\infty(D)$ , then by formula (10),

$$\begin{aligned} \langle q, \psi \rangle &= -\frac{1}{4} \int_{S_1} h \frac{\partial \psi}{\partial \bar{z}_1} dz \wedge d\bar{z}_1 - \frac{1}{4} \int_{S_1} h \frac{\partial \psi}{\partial \bar{z}_2} dz \wedge d\bar{z}_2 \\ &= -\frac{1}{4} \int_{S_1} h \bar{\partial} \psi \wedge dz. \end{aligned}$$

But on  $S_1$   $h$  satisfies the Cauchy-Riemann conditions, and hence  $h \bar{\partial} \psi = \bar{\partial}(h\psi)$  there, but  $\bar{\partial}(h\psi) \wedge dz = d(h\psi) \wedge dz = d(h\psi dz)$ , and then Stokes's formula gives

$$\langle q, \psi \rangle = -\frac{1}{4} \int_{S_1} d(h\psi dz) = -\frac{1}{4} \int_{\partial S_1} h\psi dz = 0,$$

since  $\psi = 0$  in a neighborhood of  $\partial S_1$ . This also means that  $q = 0$  in the sense of distributions.

Since the assertion of the theorem is local, then without loss of generality we may assume that  $D$  is a domain of holomorphy. Then each form with generalized coefficients, closed in  $D$ , is exact, i.e., there exists a distribution  $u$  in  $D$  such that  $\bar{\partial}u = \omega$  or  $\partial u / \partial \bar{z}_\nu = p_\nu$  ( $\nu = 1, 2$ ). By construction we have  $p_\nu|_{U_{\pm 2}} = \partial f_{\pm 2} / \partial \bar{z}_\nu$ , and hence, setting  $f_{\pm 2} - u = h_{\pm 2}$ , we will find that

$$\frac{\partial h_2}{\partial \bar{z}_\nu} = \frac{\partial f_2}{\partial \bar{z}_\nu} - p_\nu = 0 \quad \text{in } U_2, \quad \frac{\partial h_{-2}}{\partial \bar{z}_\nu} = \frac{\partial f_{-2}}{\partial \bar{z}_\nu} - p_\nu = 0 \quad \text{in } U_{-2}.$$

But a generalized solution of the Cauchy-Riemann equations is a holomorphic function, so that  $h_2 \in \mathcal{O}(U_2)$ ,  $h_{-2} \in \mathcal{O}(U_{-2})$ . Moreover, since the supports of the functions  $p_\nu$  are concentrated on  $S_1$ , then the function  $u$  is holomorphic in the domains  $U_{\pm 1}$ , and we can set  $h_1 = -u$  in  $U_1$  and  $h_{-1} = -u$  in  $U_{-1}$ . Now it is easy to see that  $h_{\alpha\beta} = h_\beta - h_\alpha$  for all  $\alpha, \beta = \pm 1$ , i.e.,  $\{h_{\alpha\beta}\}$  is a holomorphic coboundary.  $\blacktriangleright$

We remark that in the general formulation of Pinchuk's theorem, as in Bogolyubov's original theorem, it is assumed only that the functions  $f^\pm$  have limit values in the sense of distributions on  $M$  and that they are equal in the same sense. The condition that the manifold  $M$  is generating is essential: if, for example,  $M$  is contained in a complex hypersurface, then there are functions  $f^\pm \in \mathcal{O}(D^\pm)$ , equal to zero on  $M$ , but not having extensions in a neighborhood of  $M$  to a holomorphic function.

The classical theorem of Bogolyubov is obtained from Theorem 2 in the special case when  $M$  is a domain in  $\mathbb{R}^n$ , the real subspace of  $\mathbb{C}^n$ . In this theorem, moreover, an estimate is given of the domain into which the functions  $f^\pm$  extend. Its proof can be found in §27 of the book by Vladimirov cited at the end of subsection 40.

Bogolyubov's theorem is related to the so-called *jump problem*: in a domain  $D \subset \mathbb{C}^n$  suppose there is a real hypersurface  $S$  that divides  $D$  into two parts  $D_+$  and  $D_-$ , and that a function  $f$  is given on  $S$ ; the problem is to find a representation of  $f$  as a difference

$$f = h_+ - h_- \tag{11}$$

of the boundary values of functions that are holomorphic in  $D_+$  and  $D_-$  respectively. Here the function  $f$  is permitted to be only locally integrable, and the boundary values are understood in the sense of distributions. The solution of the jump problem in a general formulation was obtained by E. M. CHIRKA.<sup>(41)</sup>

It is easy to obtain a necessary condition for the solvability of this problem: the function  $f$  must satisfy the weak Cauchy-Riemann conditions on  $S$ , i.e., it must satisfy the relation (2) on  $S$  with  $l = n$  and  $m = n - 1$ .

<sup>(41)</sup>E. M. CHIRKA, *Analytic representation of CR-functions*, Mat. Sb. 98 (140) (1975), no. 4, 591-623; English transl., Math. USSR-Sb. 27 (1975), 526-553.

Chirka proved that this condition is also sufficient for the local solvability of the jump problem, and for its solvability in the complete form it is necessary to require in addition that the first cohomology group of the domain  $D$  with holomorphic coefficients be trivial:  $H^1(D, \mathcal{O}) = 0$ . Under various additional conditions on the surface  $S$  and on the function  $f$  he proved that the solution of the problem possesses the corresponding boundary properties. For example, if  $S \in C^k$  and  $f \in C^k(S)$ , where  $k \geq 1$ , then  $h_{\pm} \in C^{k-\varepsilon}(\bar{D}_{\pm})$  for any  $\varepsilon > 0$ , and condition (11) holds in the ordinary sense.

The jump theorem has been applied in many problems of complex analysis.

### Problems

1. Let  $D$  be a domain in  $\mathbb{C}^n$  and  $K \subset\subset D$ . Prove that then any holomorphic mapping  $f: D \rightarrow K$  has one and only one fixed point.

2. Prove that if the sequence of biholomorphic mappings  $f^{\nu}: D \xrightarrow{\text{onto}} G$ , where  $D$  and  $G$  are bounded domains in  $\mathbb{C}^n$ , converges uniformly on compact subsets of  $D$ , then the limit mapping  $f$  is either biholomorphic or maps  $D$  onto an analytic set belonging to  $\partial D$ .

3. If the sequence of biholomorphic mappings  $f^{\nu}: D \rightarrow D$  converges uniformly on compact subsets of the domain  $D$ , prove that then the limit mapping  $f$  is either biholomorphic or degenerate in the sense that the Jacobian  $J_f(z) \equiv 0$  in  $D$ .

4. Let  $D$  be a bounded domain in  $\mathbb{C}^n$  and  $K$  a compact subset of  $D$ . Then the set of all automorphisms  $\varphi$  of  $D$  such that  $\varphi(a) \in K$ , where  $a$  is some fixed point of  $D$ , is compact in the space  $\mathcal{O}(D, D)$  with the topology of uniform convergence on compact subsets of  $D$ .

5. If  $\varphi_1$  and  $\varphi_2$  are holomorphic mappings of the domain  $D$  into itself and  $\varphi = \varphi_1 \circ \varphi_2$  is an automorphism of  $D$ , prove that  $\varphi_1$  and  $\varphi_2$  are also automorphisms.

6. A domain  $D \subset \mathbb{C}^n$  is said to be homogeneous if, for any pair of points  $a, b \in D$  there is an  $f \in \text{Aut } D$  such that  $f(a) = b$ . Prove that any bounded homogeneous domain is a domain of holomorphy.

7. A group  $\Gamma$  of automorphisms  $\varphi$  of a domain  $D \subset \mathbb{C}^n$  is said to be discrete if the set of images  $\varphi(z)$  of a fixed point  $z \in D$  under all the possible  $\varphi \in \Gamma$  does not have limit points in  $D$ . Prove that for any discrete group  $\Gamma$  of automorphisms of  $D$  the series  $\sum_{\varphi \in \Gamma} |J_{\varphi}|^2$ , where  $J_{\varphi}$  is the Jacobian of the mapping  $\varphi$ , converges uniformly on any compact subset of  $D$ .

8. Let  $\Gamma$  be a discrete group of automorphisms of a domain  $D \subset \mathbb{C}^n$ , and let  $D/\Gamma$  be the set of equivalence classes under the relation:

$$z' \sim z'' \text{ if there exists a } \varphi \in \Gamma \text{ such that } \varphi(z') = z''.$$

If the domain  $D$  is bounded and the set  $D/\Gamma$  is compact, prove that  $D$  is a domain of holomorphy.

9. Prove that for the tubular cone  $T = K \times \mathbb{R}^n(y)$ , where  $K$  is a cone in  $\mathbb{R}^n(x)$  with vertex  $x = 0$ , to be biholomorphically equivalent to a bounded domain it is necessary and sufficient that  $K$  not contain lines.

10. Prove that for a tubular domain of holomorphy to be biholomorphically equivalent to a bounded domain it is necessary and sufficient that its base not contain lines.

11. Let  $D$  and  $G$  be domains in  $\mathbb{C}^n$ ,  $n > 1$ , with smooth boundaries. Prove that if  $D$  is strictly pseudoconvex and on  $\partial G$  there is a point where the Levi form has a negative eigenvalue, then  $D$  and  $G$  cannot be biholomorphically equivalent.

12. Prove that there do not exist proper holomorphic mappings of the bidisc  $U^2$  onto the ball  $B^n$  of any dimension  $n$  and the same thing for mappings of  $B^n$  onto  $U^2$ .

13. Let  $f: U \rightarrow B^n$ ,  $f(0) = 0$  be a holomorphic imbedding of the disc  $U = \{|z| < 1\}$  into the ball  $B^n$ . If the restriction to  $f(U)$  of the Bergman metric in  $B^n$  coincides with induced metric via this embedding of the Lobachevskii metric in  $U$ , then  $f(U)$  is the intersection of  $B^n$  with a complex line  $l \ni 0$ .

14. Prove that on any hyperbolic manifold  $M$  the Kobayashi metric induces the topology

of  $M$ , i.e., that the set of Kobayashi balls forms a basis of open sets on  $M$  with the usual topology.

15. Prove that the set  $M$  which is obtained from  $\mathbb{C}^2$  by discarding the complex lines  $\{z_1 = 0\}$ ,  $\{z_1 = 1\}$ ,  $\{z_2 = 0\}$ , and  $\{z_1 = z_2\}$  is hyperbolic.

16. If two entire functions  $f$  and  $g$  of one variable satisfy the identity  $f^m + g^n = 1$ , where  $m$  and  $n$  are integers such that  $1/m + 1/n < 1$ , then  $f$  and  $g$  are constant. [HINT: prove that the curve  $\{z_1^m + z_2^n = 1\} \subset \mathbb{C}^2$  is a hyperbolic manifold.]

17. (A. V. ABROSIMOV) Let  $S = \{(z, w) \in \mathbb{C}^2: w = t + i\varphi(z)\}$  be a smooth real hypersurface ( $t \in \mathbb{R}$  and  $\varphi$  is a real function), and let  $Z = \frac{\partial}{\partial \bar{z}} + a \frac{\partial}{\partial t}$  be the tangential Cauchy-Riemann operator on it. Prove that if the identity  $Z^{n+1}(f) = 0$  holds for a smooth CR-function  $f$  on  $S$ , then there is a polynomial  $P_n$  of  $z$  and  $w$  of degree  $n$  such that  $f = P_n|_S$ .

## APPENDIX

# Complex Potential Theory

Here we shall give of necessity a cursory survey of several themes that complement the main presentation. These themes are mostly concerned with higher-dimensional generalizations of harmonic functions related to the complex structure of  $\mathbb{C}^n$ .

**1. Plurisubharmonic measure.** In a number of questions of the function theory of one complex variables an important role is played by the *harmonic measure* of a subset  $E$  of the closure of some domain  $D \subset \mathbb{C}$ . This measure is a function  $\omega_D(z, E)$ , which at each point  $z$  is equal to the supremum of the values at this point of functions  $u$  belonging to the class  $\text{sh}(D)$  of subharmonic functions in  $D$ , which are nonpositive in  $D$  and do not exceed  $-1$  on  $E$ . The function  $\omega_D(z, E)$  turns out to be harmonic in  $D \setminus \bar{E}$  (this is what justifies the name); to learn about its properties, see, for example, the book by G. M. GOLUZIN, *Geometric theory of functions of a complex variable*, 2nd ed., "Nauka", Moscow, 1966; English transl., Transl. Math. Monographs, vol. 26, Amer. Math. Soc., Providence, RI, 1969. (We remark that the function  $\omega_D$  considered here is expressed using the classical  $\omega$  via the formula  $\omega_D = 1 - \omega$ ; this is due to the fact that we prefer to deal with subharmonic functions, not with superharmonic ones.)

When we pass to domains  $D \subset \mathbb{C}^n$ ,  $n > 1$ , it is natural to replace  $\text{sh}(D)$  by the class  $\text{psh}(D)$  of plurisubharmonic functions in  $D$ :

$$\omega_D(z, E) = \sup\{u(z) : u \in \text{psh}(D), u \leq 0, u|_E \leq -1\}. \quad (1)$$

However, for  $n > 1$  it is not only not harmonic, but not even upper semicontinuous. Therefore, instead of  $\omega_D$  we consider its so-called UPPER REGULARIZATION

$$\omega_D^*(z, E) = \limsup_{z' \rightarrow z} \omega_D(z', E), \quad (2)$$

which is already upper semicontinuous and, hence, plurisubharmonic in  $D \setminus E$ . This function is called the *plurisubharmonic measure*, or, more briefly, the *p-measure* of a set relative to the domain  $D$ .<sup>(1)</sup>

Although the unregularized function  $\omega_D$  is equal to  $-1$  on the set  $E$ , under regularization a jump upwards can occur at some points of  $E$ . A

<sup>(1)</sup>See the paper by A. SADULLAEV, *Plurisubharmonic measures and capacities on complex manifolds*, Uspekhi Mat. Nauk 36 (1981), no. 4, 53–105; English transl., Russian Math. Surveys 36 (1981), no. 4, 61–119. See also the author's book, cited at the end of §20.

closed set  $E \subset \bar{D}$  is said to be *pluriregular* if such jumps do not arise, i.e.,  $\omega_D^*|_E = -1$ . A domain  $D$  is said to be *strongly Pseudoconvex* if it is bounded and if its defining function belongs to  $C(\bar{D}) \cap \text{psh}(\bar{D})$ . If a domain  $D$  is strongly pseudoconvex and  $E \subset\subset D$  is a pluriregular set, then V. P. ZAKHARYUTA showed in 1976 that the function  $\omega_D^*(z, E)$  is continuous in  $D$ .

Just as for  $n = 1$  the function  $\omega_D$  satisfies the Laplace equation in  $D \setminus E$ , its higher-dimensional analogue  $\omega_D^*$  is related to a nonlinear partial differential equation, the so-called complex Monge-Ampère equation. In fact this equation appears in a number of problems as a natural higher-dimensional analogue of the Laplace equation, reflecting (in contrast to the higher-dimensional Laplace equation) the complex structure of  $\mathbb{C}^n$ .

For functions of class  $C^2$  in a domain  $D \subset \mathbb{C}^n$  the complex Monge-Ampère operator is defined as the  $n$ th exterior power of the operator  $dd^c = \frac{i}{2} \partial \bar{\partial}$  (see subsection 18):

$$(dd^c u)^n = n! \det \left( \frac{\partial^2 u}{\partial z_j \partial \bar{z}_k} \right) \prod_{j=1}^n \frac{i}{2} dz_j \wedge d\bar{z}_k \quad (3)$$

and the *complex Monge-Ampère equation* in  $\mathbb{C}^n$  has the form<sup>(2)</sup>

$$(dd^c u)^n = 0 \Leftrightarrow \det \left( \frac{\partial^2 u}{\partial z_j \partial \bar{z}_k} \right) = 0. \quad (4)$$

For  $n = 1$  this equation is the same as the Laplace equation.

If  $u$  is a plurisubharmonic function of class  $C^2$ , then  $dd^c u \geq 0$  (see subsection 38). Using the theory of so-called positive currents, BEDFORD and TAYLOR<sup>(3)</sup> defined a Monge-Ampère operator in the generalized sense for arbitrary continuous and even for locally bounded plurisubharmonic functions.

The Dirichlet problem for the Monge-Ampère equation in a domain  $D \subset \mathbb{C}^n$  consists in finding a solution of this equation which takes given values  $\varphi$  on the boundary  $\partial D$ . For  $n = 1$  one of the methods of solving this problem is PERRON'S METHOD; extending it to domains  $D \subset \mathbb{C}^n$ ,  $n > 1$ , we consider the function

$$\omega(z) = \sup\{u(z) : u \in \text{psh}(D), u|_{\partial D} \leq \varphi\}; \quad (5)$$

its upper regularization  $\omega^*(z) = \limsup_{z' \rightarrow z} \omega(z') \in \text{psh}(D)$ . If in addition  $D$  is strictly pseudoconvex and  $\varphi \in C(\partial D)$ , then Bedford and Taylor proved that  $\omega^*$  is a distributional solution of the Dirichlet problem. These same authors proved a *maximality property* for continuous plurisubharmonic solutions of the Monge-Ampère equations: if  $u \in C(\bar{D})$  is such a solution, and

<sup>(2)</sup>The real Monge-Ampère equation in domains  $D \subset \mathbb{R}^n$  is the equation  $\det \left( \frac{\partial^2 u}{\partial x_j \partial x_k} \right) = 0$ ; it plays an important role in geometry.

<sup>(3)</sup>E. BEDFORD AND B. A. TAYLOR, *The Dirichlet theorem for a complex Monge-Ampère equation*, Invent. Math. 37 (1976), 1-44.

$v \in \text{psh}(D) \cap C(\bar{D})$  is an arbitrary function, then

$$u|_{\partial D} \geq v|_{\partial D} \Rightarrow u(z) \geq v(z), \quad z \in D. \tag{6}$$

Under the conditions mentioned above this property obviously guarantees the uniqueness of the solution of the Dirichlet problem for the Monge-Ampère equation.

**THEOREM 1.** *If  $D$  is a pseudoconvex domain and  $E \subset\subset D$  is a pluriregular set, then the  $p$ -measure  $\omega_D^*(z, E)$  is a continuous solution of the Monge-Ampère equation everywhere in  $D \setminus E$ .*

◀ Let  $B \subset\subset D \setminus E$  be an arbitrary ball and  $u_B$  the solution of the Dirichlet problem  $(dd^c u)^n = 0$ ,  $u|_{\partial B} = \omega_D^*|_{\partial B}$ ; under the hypotheses  $\omega_D^* \in C(\bar{D})$ , and the solution of this problem exists and is continuous in  $\bar{B}$ . In view of the maximality property (6) we have  $u_B(z) \geq \omega_D^*(z, E)$  everywhere in  $B$ . Therefore the function

$$v(z) = \begin{cases} u_B(z) & \text{if } z \in \bar{B}, \\ \omega_D^*(z, E) & \text{if } z \in D \setminus \bar{B} \end{cases}$$

belongs to  $\text{psh}(D)$  as it is the upper envelope of two plurisubharmonic functions. It is nonpositive in  $D$  (since it could take positive values only in  $B$ , and then it would attain its maximum there, which contradicts the plurisubharmonicity) and is equal to  $-1$  on  $E$ . Thus, by the definition of  $p$ -measure  $v(z) \leq \omega_D^*(z, E)$  in  $D$  and, in particular,  $u_B(z) \leq \omega_D^*(z, E)$  in  $B$ . Combining this with the opposite equality obtained above, we find that  $\omega_D^*$  in  $B$  coincides with the solution of the Monge-Ampère equation. ▶

**REMARK.** From this proof we see that any continuous plurisubharmonic function in a domain  $D$  which possesses the maximality property in subdomains  $G \subset\subset D$  is a distributional solution of the Monge-Ampère equation in  $D$ .

We shall indicate the connection between the  $p$ -measure and thin sets (i.e., subsets of  $D$  on which some function  $\neq -\infty$  from  $\text{psh}(D)$  is equal to  $-\infty$ ; see page 354 above); such subsets are termed *pluripolar*. By the maximum principle the  $p$ -measure  $\omega_D^*(z, E)$  is either nowhere vanishing in  $D$  or  $\equiv 0$ . A. SADULLAEV proved (see the article cited at the beginning of this appendix) that the latter case characterizes pluripolar sets.

**THEOREM 2.** *If a domain  $D$  is strongly pseudoconvex, then a set  $E \subset D$  is pluripolar if and only if  $\omega_D^*(z, E) \equiv 0$ .*

We note another generalization of the TWO-CONSTANT theorem, which follows simply from the definition of  $p$ -measure.

**THEOREM 3.** *Let  $u$  be a plurisubharmonic function in a domain  $D \subset \mathbb{C}^n$  with  $u \leq m$  on some set  $E \subset \bar{D}$  and not exceeding  $M$  anywhere in  $D$ . Then for all  $z \in D$*

$$u(z) \leq M(1 + \omega_D^*(z, E)) - m\omega_D^*(z, E). \tag{7}$$

For other applications of  $p$ -measure see, for example, the author's book cited at the end of §20.



**2. Invariant Green's function.** Green's function of a domain  $D \subset \mathbb{C}$  is the fundamental solution of the Laplace equation with a singularity of type  $\ln|z-w|$  at a fixed point  $w \in D$ , and is equal to 0 on  $\partial D$ . We shall describe a higher-dimensional generalization of this, due to E. A. POLETSKIĬ, which reflects the complex structure; the role of the Laplace equation here is again taken by the Monge-Ampère equation.

In a domain  $D \subset \mathbb{C}^n$  we fix two distinct points  $z$  and  $w$ , we consider a holomorphic mapping  $f$  of the unit disc  $U \subset \mathbb{C}$  into  $D$  such that  $f(0) = z$ , and we write

$$u_f(z, w) = \sum_{\zeta_\nu \in f^{-1}(w)} k_\nu \ln|\zeta_\nu|, \quad (1)$$

where the sum is taken over all inverse images  $\zeta_\nu \in U$  of the point  $w$ , and  $k_\nu$  is the multiplicity of  $f$  at the point  $\zeta_\nu$  (see Problem 1 to Chapter III); if there are no such inverse images, we set  $u_f = 0$ . We shall call the function

$$g_D(z, w) = \inf u_f(z, w), \quad (2)$$

where the infimum is taken over all holomorphic mappings  $f: U \rightarrow D$ ,  $f(0) = z$ , the *invariant Green's function* of the domain  $D$  with a singularity at the point  $w$ .

It is obvious that  $g_D(z, w) \leq 0$ , and for bounded domains in a neighborhood of  $w$  we have  $g_D(z, w) = \ln|z-w| + O(1)$ , where  $O(1)$  is a bounded function. It is also obvious that  $g_D$  is invariant relative to biholomorphic mappings, and this is what justifies the name.

Proofs of the following results can be found in the paper by E. A. POLETSKIĬ and the author, *Invariant metrics*, Itogi Nauki i Tekhniki: Sovremennye Problemy Mat.: Fundamental'nye Napravleniya, vol. 9, VINITI, Moscow, 1986, pp. 73–127; English transl. in Encyclopedia of Math. Sci., vol. 9 (Several Complex Variables. III), Springer-Verlag, Berlin, 1989.

**THEOREM 1.** For any fixed  $w \in D$  the function  $g_D$  is plurisubharmonic with respect to  $z$  in the domain  $D$ .

**THEOREM 2.** The function  $g_D(z, w)$  can be defined by the relation

$$g_D(z, w) = \sup v_w(z), \quad (3)$$

where the supremum is taken over all nonpositive functions  $v_w \in \text{psh}(D)$  in  $D$ , which in a neighborhood of a point  $w \in D$  have the form  $\ln|z-w| + O(1)$ .

**THEOREM 3.** If  $D \subset \mathbb{C}^n$  is a strongly pseudoconvex domain, then the function  $g_D(z, w)$  satisfies the complex Monge-Ampère equation with respect to  $z$  in  $D$ .

**COROLLARY.** For  $n = 1$  the function  $g_D(z, w)$  coincides with the classical Green's function.

The invariant Green's function is related to the invariant metrics of Carathéodory and Kobayashi. We shall call the function

$$c_1(z, w) = \inf \ln(1/|f_w(z)|), \tag{4}$$

where the infimum is taken over holomorphic functions  $f_w: D \rightarrow U$ ,  $f_w(w) = 0$ , the Carathéodory function of the domain  $D \subset \mathbb{C}^n$ . The Kobayashi function of the domain  $D$  is defined as

$$k_1(z, w) = \sup(1/|\zeta|), \tag{5}$$

where the supremum is taken over all holomorphic curves  $f_z: U \rightarrow D$ ,  $f_z(0) = z$ , and  $\zeta$  is an inverse image of the point  $w \in D \setminus \{z\}$  with smallest modulus. These functions are connected by a simple relation, respectively, with the Carathéodory distance  $c_D(z, w)$  and with the "one-link distance" of Kobayashi  $\tilde{k}(z, w)$  (see the exercise following the proof of Theorem 1 of subsection 58).

Both functions  $c_1$  and  $k_1$  are symmetric relative to their arguments and are lower semicontinuous with respect to each of them. For bounded domains  $D$  in a neighborhood of the point  $w$  they both have the form  $-\ln|z - w| + O(1)$ . It is not hard to see that these functions are related to the invariant Green's function of the domain  $D$  via the two-sided inequality

$$k_1(z, w) \leq -g_D(z, w) \leq c_1(z, w). \tag{6}$$

The Carathéodory function  $c_1(z, w)$  is plurisuperharmonic with respect to each argument when the other one is fixed, but the Kobayashi function does not always possess this property. If it is plurisuperharmonic, then  $-k_1(z, w) \in \text{psh}(D \times D)$ , and, in view of (6),  $-k_1(z, w) \geq g_D(z, w)$ ; Considering also that  $-k_1$  has a singularity of the necessary form, by Theorem 2 we conclude that in this case  $k_1(z, w) \equiv -g_D(z, w)$ . If for some domain  $D$  the Carathéodory distance  $c_D$  and the Kobayashi distance  $\tilde{k}_D$  coincide, then  $k_1 \equiv c_1$  for this domain; in view of (6) these functions then coincide with  $-g_D$ , and, hence, are plurisuperharmonic and satisfy the Monge-Ampère equation. L. LEMPERT proved (see the reference at the beginning of subsection 62) that these three functions coincide for all geometrically convex domains  $D \subset \mathbb{C}^n$ .

**3. Pseudoconcave sets.** A closed subset  $\Sigma$  of a domain  $D \subset \mathbb{C}^n$  is said to be *Pseudoconcave* if its complement  $D \setminus \Sigma$  is pseudoconvex. Following E. M. CHIRKA, we consider some results connected with such sets. These results are centered around Hartogs's theorem of the analyticity of the set of singularities from subsection 42. Since the set of singularities of a holomorphic function is pseudoconcave, the Hartogs's theorem can be reformulated as follows: if the pseudoconcave set  $\Sigma = \{(z, w): z \in D, w \in \mathbb{C}\}$  is the graph of some function  $g$ , then this function is holomorphic in  $D$ .

We need a local MAXIMUM PRINCIPLE for plurisubharmonic functions.

**THEOREM 1.** *Let  $\Sigma$  be a pseudoconcave subset of a domain  $D \subset \mathbb{C}^n$  and let  $u \in \text{psh}(D)$ . Then for any domain  $G \subset\subset D$*

$$\max_{\Sigma \cap \bar{G}} u = \max_{\Sigma \cap \partial G} u. \tag{1}$$

◀ Suppose that  $M = \max_{\Sigma \cap \bar{G}} u$  is attained at an interior point  $z^0 \in G$ , and  $\max_{\Sigma \cap \partial G} u < M$ . Without loss of generality the function  $u$  can be assumed to be strictly plurisubharmonic, and that the maximum is strict (see subsection 38). Then the real hypersurface  $S = \{z \in G: u(z) = M\}$  lies entirely, except for the point  $z^0$ , outside of  $\Sigma$ . Since the set where  $u(z) > M$  is not a domain of holomorphy, then there is a family of holomorphic discs  $S_t$ ,  $0 < t < 1$ , lying outside of  $\Sigma$ , which tends as  $t \rightarrow 0$  to the disc  $S_0$ , where  $\partial S_0$  lies outside of  $\Sigma$ , but  $S_0 \ni z^0$ . According to the continuity principle (subsection 36), the complement to  $\Sigma$  then cannot be a domain of holomorphy. ▶

For what follows we assume that  $\Sigma \subset D \times \mathbb{C}$ , where  $D \subset \mathbb{C}^n$ , and the projection  $\pi: \Sigma \rightarrow D$  is a proper mapping.<sup>(4)</sup> For  $z \in D$  we write  $\Sigma_z = \{w \in \mathbb{C}: (z, w) \in \Sigma\}$ .

We need the following assertion: an upper semicontinuous function  $\varphi > 0$  in  $D \subset \mathbb{C}$  has a subharmonic logarithm if the maximum principle holds for  $|e^p| \varphi$ , where  $p = p(z)$  is an arbitrary polynomial. The idea of the proof is based on the fact that if  $\text{Re } p + \ln \varphi$  possesses this property, then  $h + \ln \varphi$  also possesses it, where  $h$  is an arbitrary harmonic function, and the subharmonicity of  $\ln \varphi$  is easy to derive from this.

**LEMMA 1.** *If  $D$  is a domain in  $\mathbb{C}^n$ ,  $\Sigma \subset D \times \mathbb{C}$  is a pseudoconcave set, and  $u \in \text{psh}(D \times \mathbb{C})$ , then the function*

$$v(z) = \max_{w \in \Sigma_z} u(z, w) \in \text{psh}(D). \tag{2}$$

◀ The upper semicontinuity of  $v$  is obvious, and we need only check that its restriction to any complex line  $l$  is subharmonic in  $l \cap D$ . Therefore without loss of generality we may assume that  $D \subset \mathbb{C}$ . It suffices to prove that the maximum principle holds for the function  $|e^p| e^v$ , where  $p$  is an arbitrary polynomial.

Let  $U \subset\subset D$  be the disc and suppose that the maximum is attained in it at a point  $z_0$ , where  $|e^{p(z_0)}| e^{v(z_0)} = \max_{w \in \Sigma_{z_0}} |e^{p(z_0)}| e^{u(z_0, w)}$ . But the function  $|e^{p(z)}| e^{u(z, w)} \in \text{psh}(D \times \mathbb{C})$ , and the set  $\Sigma$  is pseudoconcave, so that by Theorem 1 we have

$$|e^{p(z_0)}| e^{v(z_0)} \leq \max_{z \in \partial U} \max_{w \in \Sigma_z} |e^{p(z)}| e^{u(z, w)} = \max_{z \in \partial U} |e^{p(z)}| e^{v(z)},$$

and the maximum principle holds. ▶

<sup>(4)</sup>We can arrive at this situation by a linear-fractional transformation, considering the intersections of  $\Sigma \subset \mathbb{C}^{n+1}$  with complex lines passing through a fixed point  $a \in \mathbb{C}^{n+1} \setminus \Sigma$ .

From this lemma by induction on  $k$  we obtain the following:

**LEMMA 2.** *Let  $D$  be a domain in  $\mathbb{C}^n$  and suppose that  $u(z, w)$ , where  $z \in D$  and  $w = (w_1, \dots, w_k) \in \mathbb{C}^k$ , is a plurisubharmonic function in  $D \times \mathbb{C}^k$ . If  $\Sigma \subset D \times \mathbb{C}$  is a pseudoconcave set and  $\Sigma_z^k = \Sigma_z \times \dots \times \Sigma_z$  ( $k$  times), then the function*

$$v(z) = \max_{w \in \Sigma_z^k} u(z, w) \in \text{psh}(D). \tag{3}$$

A generalization of Hartogs’s theorem was obtained by K. OKA in 1934, but became accessible thanks to a 1962 paper by T. NISHINO. The latter proof is based on his theorem concerning the plurisubharmonicity of the function  $\ln \text{diam} \Sigma_z$ , where  $\Sigma$  is a pseudoconcave set. We give a stronger variant of this theorem, in which the diameter of the set  $\Sigma_z$  is replaced by its capacity. We recall that the *capacity* of a closed set  $E \subset \mathbb{C}$  is the quantity

$$\text{cap } E = \lim_{k \rightarrow \infty} \left( \max \prod_{1 \leq i < j \leq k} |w_i - w_j| \right)^{2/(k(k-1))}, \tag{4}$$

where the maximum is taken over all possible arrangements of the points  $w_1, \dots, w_k \in E$ ; the limit here exists, since the sequence decreases (see Goluzin’s book, cited at the beginning of this appendix).

**THEOREM 2.** *If  $D$  is a domain in  $\mathbb{C}^n$ , and  $\Sigma \subset D \times \mathbb{C}$  is a pseudoconcave set, then  $\text{cap} \Sigma_z$  is logarithmically plurisubharmonic in  $D$ .*

◀ If  $w_1, \dots, w_k$  are distinct points of the set  $\Sigma_z$ , then the function  $\ln \prod |w_i - w_j| = \sum \ln |w_i - w_j|$ , where the product and the sum are taken over all sets  $1 \leq i < j \leq k$ , is plurisubharmonic with respect to  $w = (w_1, \dots, w_k)$  in  $\mathbb{C}^k$ . Then by Lemma 2 we also have

$$\delta_k(z) = \frac{2}{k(k-1)} \max_{w \in \Sigma_z^k} \ln \prod |w_i - w_j| \in \text{psh}(D) \tag{5}$$

for any  $k$ . Since  $\ln \text{cap} \Sigma_z = \lim_{k \rightarrow \infty} \delta_k(z)$  and  $\delta_k(z)$  decreases as  $k$  grows, then  $\ln \text{cap} \Sigma_z \in \text{psh}(D)$ . ▶

Using Theorem 2 we can give a significantly simpler proof of OKA’s THEOREM than Nishino’s proof.

**THEOREM 3.** *Let  $D$  be a domain in  $\mathbb{C}^n$  and let  $\Sigma \subset D \times \mathbb{C}$  be a pseudoconcave set. If for each point  $z$  belonging to a nonpluripolar set  $M \subset D$  the fiber  $\Sigma_z$  consists of a finite number of points, then  $\Sigma$  is an analytic set.*

◀ We write  $M_j = \{z \in M: \text{card} \Sigma_z \leq j\}$ , where  $\text{card}$  is the number of points; this is an increasing sequence of sets, exhausting  $M$ . By the properties of the  $p$ -measure at least one of these sets, say  $M_k$ , is nonpluripolar. Then the function  $\delta_{k+1}|_{M_k} = -\infty$ , and since it is plurisubharmonic in  $D$

and  $M_k$  is not pluripolar, then  $\delta_{k+1}(z) \equiv -\infty$  in  $D$ . From this it follows that  $\text{card } \Sigma_z \leq k$  for all  $z \in D$ , and by Hartogs's theorem (at the very end of Chapter III),  $\Sigma$  is an analytic set. ►

Finally, we observe that in a cycle of papers Sadullaev has found substantial applications of the concepts of pseudoconcavity in problems of the approximation of functions of several complex variables by rational functions.

# Subject Index

- $\alpha$ -planes, 72, 88
- $\beta$ -planes, 72, 88
  
- Abel's lemma, 19
- Ahlfors' lemma, 315
- Analytic continuation, 31
- Analytic set, 129
  - critical point of an, 130
  - defining function of an, 136
  - dimension of an, 132
  - irreducible, 132
  - regular point of an, 130
  - zero-dimensional, 135
- Andreotti-Norguet formula, 229
- Anti-involution, 93
- Argument principle, 287
- Atlas, 61
  - complex, 62
  
- Barrier, 179
- Bergman
  - form, 300
  - function, 299
  - metric, 301, 314
- Biholomorphic mappings, 44
- Borel's lemma, 318
- Boundary operator  $\partial$ , 80
- Boundary uniqueness theorem, 353
  
- $\mathbb{C}$ -homogeneous norm, 43
- Capacity, 367
- Carathéodory distance, 302
- Carathéodory metric, 302
- Cauchy integral, 18
- Cauchy's inequalities, 18
- Cauchy-Fantappiè formula, 158
- Cauchy-Riemann
  - conditions, 13
  - manifolds, 342
- Cayley transform, 44
- Chain, 305
- Chart, 61
- Coboundary, 236, 237
- Coboundary operator, 243
  
- Cochain, 243
- Cocycle, 243
- Cohomology group, 79
- Cohomology group, 236, 243, 256
- Complex Euclidean space, 1
- Complex hypersurface, 132
- Complex line, 3
- Complex plane, 3
- Complex projective space, 4, 63
- Conjugate radii of convergence, 32
- Continuity principle, 190
- Contractibility property, 303
- Convexity
  - logarithmic, 30
  - polynomial, 182
  - rational, 182
- Cotangent bundle, 148
- Cotangent space, 146
- Cousin problem
  - first or additive, 235
  - localized first, 250
  - second or multiplicative, 253
- Covering, 112
  - branched, 138
  - holomorphic, 113
  - universal, 120
- CR-function, 166
- CR-manifolds, 342
- Curvature of a holomorphic curve, 315
  
- Differential form, 77, 103, 148
  - closed, 79
  - exact, 79
  - holomorphic, 78
- Differentiation of forms, 78
- Disc condition, 312
- Discriminant, 128
- Divisor, 254
  - of a meromorphic function, 234
  - positive, 254
  - proper, 254
- Domain
  - (globally) pseudoconvex, 206
  - circular, 10

- Domain (*continued*)
  - cylindrical, 10
  - globally pseudoconvex, 212
  - Hartogs, 9, 216
  - holomorphically convex, 181, 211
  - not holomorphically extendable, 196, 211
  - of bounded type, 295
  - of holomorphy, 178, 211
  - polycircular, 8
  - polycylindrical, 8
  - pseudoconvex at a point, 194, 211
  - Reinhardt, 8, 30, 215
  - strictly pseudoconvex, 194
  - tube, 10, 214
- Duality principle, 274
- Embedded edge theorem, 224
- Envelope of holomorphy, 212, 219
- Euclidean scalar product, 2
- Euclidean volume form, 321
- Exact sequence, 249
- Fatou's example, 317
- Fefferman, C., 332
- Fiber space, 141
- Fubini-Study metric, 5, 109, 314
- Function
  - $\mathbb{C}$ -differentiable, 12
  - $\mathbb{R}$ -differentiable, 12
  - antiholomorphic, 15
  - holomorphic, 13
  - pluriharmonic, 15
  - plurisubharmonic, 200
  - strictly plurisubharmonic, 201
- Function-theoretic space, 6
- Fundamental group, 117
- Generalized unit disc, 44
- Generalized upper half-plane, 11
- Global defining function, 261
- Grassmann manifold, 63
- Griffiths' lemma, 325
- Group of holomorphic cocycles, 236
- Hartogs
  - fundamental theorem, 28
  - lemma, 9, 26
  - radius, 34, 206
  - series, 34, 208
- Hartogs-Laurent series, 36
- Hermitian form, 101
  - positive, 102
- Hermitian metric form, 102
- Hermitian scalar product, 2
- Holomorphic automorphism, 45
  - of the ball, 45
  - of the generalized upper half-plane, 49
  - of the polydisc, 48
- Holomorphic bundle, 143
- Holomorphic cocycle, 235
- Holomorphic convexity, 181
- Holomorphic curvature, 315
- Holomorphic curve, 39, 188
- Holomorphic disc, 188
- Holomorphic extension, 177
- Holomorphic isomorphism, 45
- Holomorphic mapping, 39
- Holomorphic surface, 188
- Holomorphically convex hull, 181
- Hyperbolic manifold, 308, 311
- Hyperplane
  - complex, 2
  - real, 2
- Index of a cycle, 111
- Integral of a form, 79
- Inverse and implicit function theorems, 40
- Irreducible function, 128
- Jump problem, 358
- $k$ -dimensional chains, 79
- Kernel function, 296
- Klein quadric, 65
- Kobayashi distance, 305
- Kobayashi metric, 305
- Laplacian, 17
- Leray
  - coboundary operator, 282
  - formula, 160
  - theory, 278
- Levi determinant, 230
- Levi form, 345
- Levi problem, 196, 262, 264
- Lifting, 112
- Light cone, 67
- Lindelöf's theorem, 349
- Lobachevskii metric, 308, 315
- Local coordinates, 61
- Locally defining function, 193
- Logarithmic residue, 286
- Lorentz metric, 76
- Manifold, 61
  - complex, 62
  - generating, 101, 342
  - Hermitian, 313
  - holomorphically separated, 218
  - Kähler, 314
  - maximally complex, 100, 342
  - totally real, 100, 342
- Martinelli-Bochner integral formula, 157
- Maximality property, 362
- Maximum modulus principle, 21, 189
- Maximum principle, 43, 66, 205
- Maxwell's equations, 86, 267, 268
- Meromorphic curve, 228
- Meromorphic function, 231

Minkowski space, 67  
     complex, 67  
     complex, Euclidean subspace of, 94, 143  
     complex, projective, 69  
 Monge-Ampère equation, 362  
 Montel property, 311  
  
 Order of zero, 287  
 Osgood condition, 289  
 Osgood's lemma, 26  
  
 $\bar{\partial}$ -problem, 239  
 Penrose transformation, 70, 90  
 Plücker coordinates, 64  
 Pluripolar set, 363  
 Pluriregular set, 362  
 Plurisubharmonic measure, 361  
 Poincaré form, 112  
 Poincaré problem, 262  
 Poisson bracket, 345  
 Polar set of a function, 231  
 Pole, 231  
 Polycylinder, 6  
 Polydisc, 6  
 Polydisc of convergence, 32  
 Presheaf, 150  
 Pseudoconcave set, 365  
 Pseudoconvexity  
     global, 206  
     local, 192  
  
 Real subspace, 1  
 Removal of compact singularities theorem,  
     172  
 Residue, 275  
 Residue class, 283  
 Residue relative to a singular cycle, 277  
 Residue theorem, 275  
 Resultant, 127  
 Ricci form, 322  
 Riemann's extension theorem, 175  
 Runge domain, 166  
  
 Sadullaev, A., 348  
 Schwarz lemma, 43, 315  
 Section of a bundle, 141  
 Section of a sheaf, 149  
 Semimetric, 303  
 Series in homogeneous polynomials, 36  
 Set of uniqueness, 352  
 Sheaf, 148  
 Shilov boundary, 22  
 Simultaneous extension lemma, 183  
 Singular cycle, 276  
 Skeleton, 7  
 Stein manifolds, 223  
 Stokes's formula, 81, 82  
 Strongly pseudoconvex set, 362  
  
 Tangent bundle, 147  
 Tangent cone, 138  
  
 Tangent plane  
     complex, 97, 99  
 Tangent space, 144  
     complex, 147  
     real, 147  
 Tangent vector, 144  
 Tangential Cauchy-Riemann conditions, 166  
     167, 265  
 Tangential Cauchy-Riemann operator, 166  
 Theorem  
     Behnke-Sommer, 189  
     Behnke-Stein, 186  
     Bochner-Severi, 169  
     Bogolyubov, 354  
     Cartan, 52  
     Cartan-Thullen, 182, 184, 222  
     Cauchy-Poincaré, 83  
     Chirka, 349  
     Dolbeault, 250  
     Forelli, 37  
     Grauert-Remmert, 206  
     Green, 318, 319  
     Hörmander, 242  
     Hartogs, 226, 228  
     Hefer, 162, 261  
     Khenkin-Pinchuk, 333  
     Kneser, 224  
     Kwack, 320  
     Levi-Civita, 99  
     Levi-Krzoska, 197  
     Liouville, 23  
     monodromy, 114  
     Oka, 259  
     Oka-Weil, 185  
     Osgood, 291  
     Picard, 317, 326  
     Pinchuk, 328, 330, 336, 341, 353  
     Remmert, 290  
     Rouché, 288  
     Serre, 256, 257  
     Weil, 162  
     Thin set, 354  
     Transition matrices, 142  
     Two-constant theorem, 363  
  
 Uniqueness theorem, 21, 66  
  
 Vector field, 148, 342  
  
 Weak Cauchy-Riemann conditions, 353  
 Webster's symmetry principle, 338  
 Weierstrass  
     preparation theorem, 123  
     division theorem, 126  
     polynomial, 125  
 Weil  
     domain, 162  
     formula, 161  
 Wirtinger theorem, 104, 107