

$$a \cdot b \cdot c = 1$$

$$V - E + F = 2$$

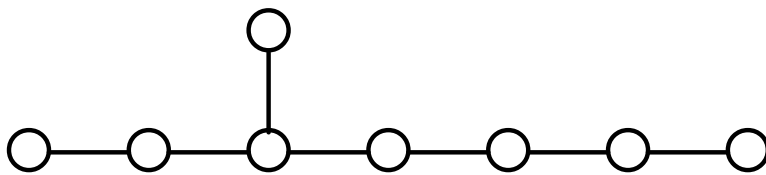

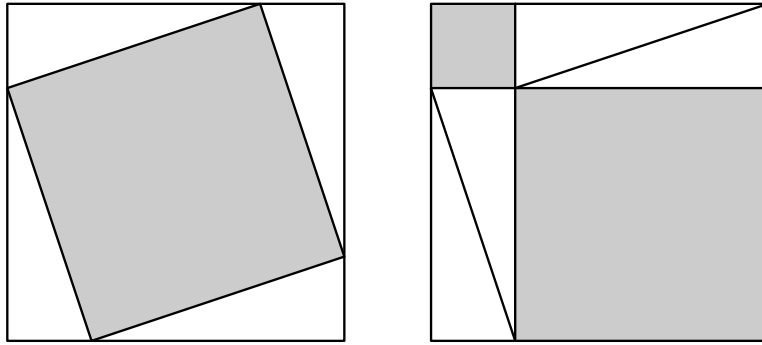

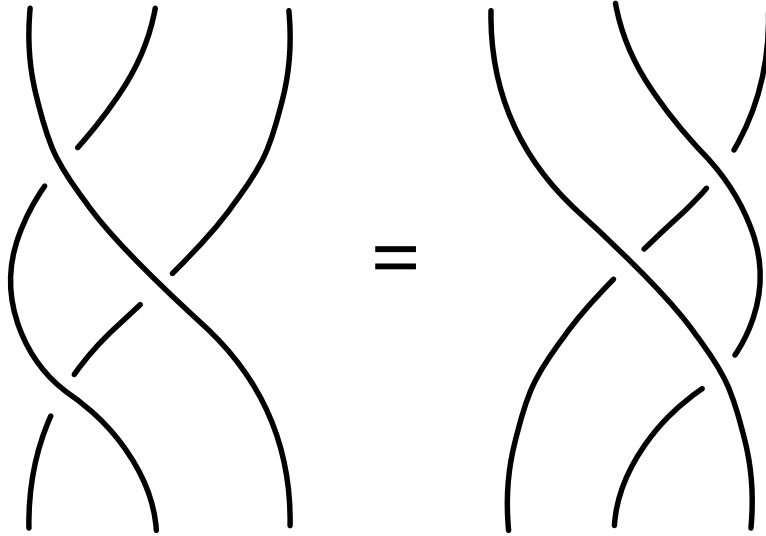
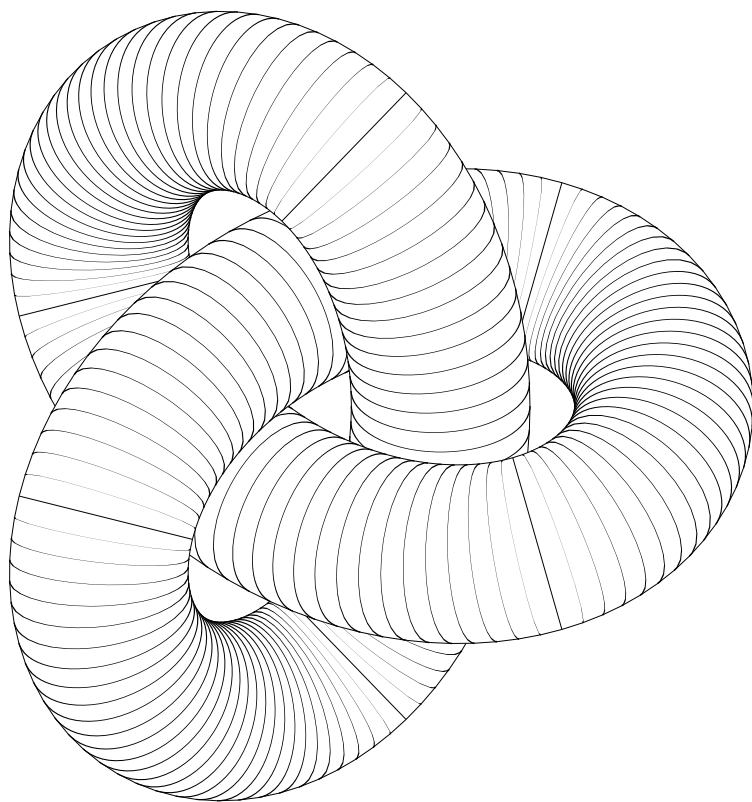
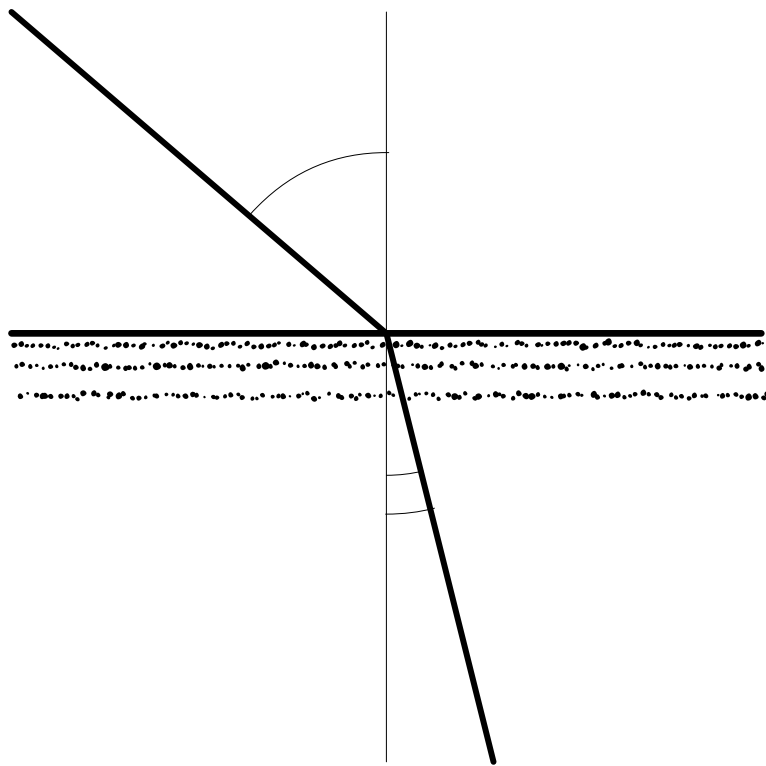

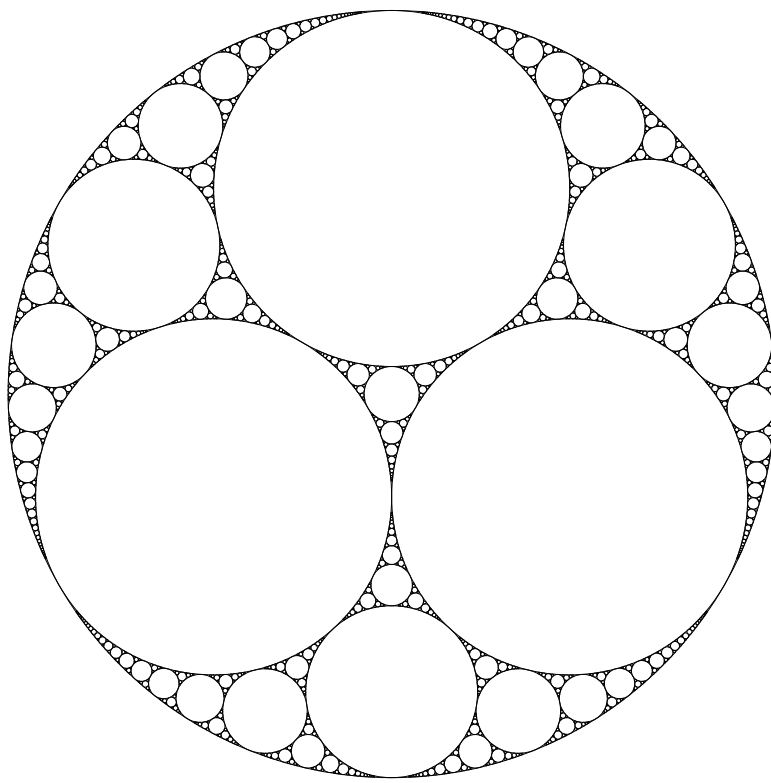

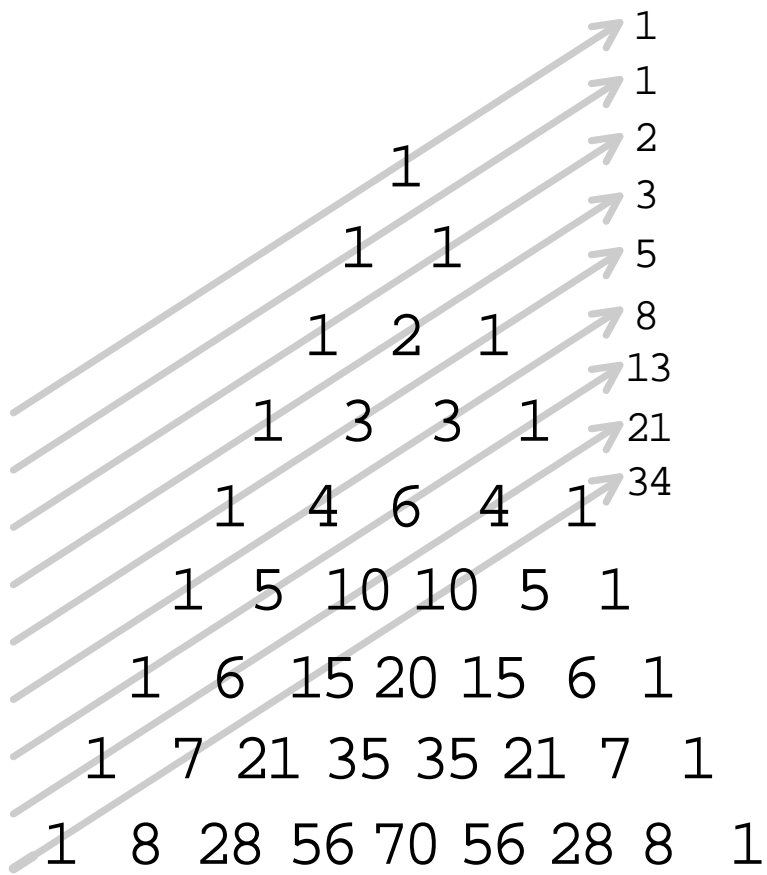

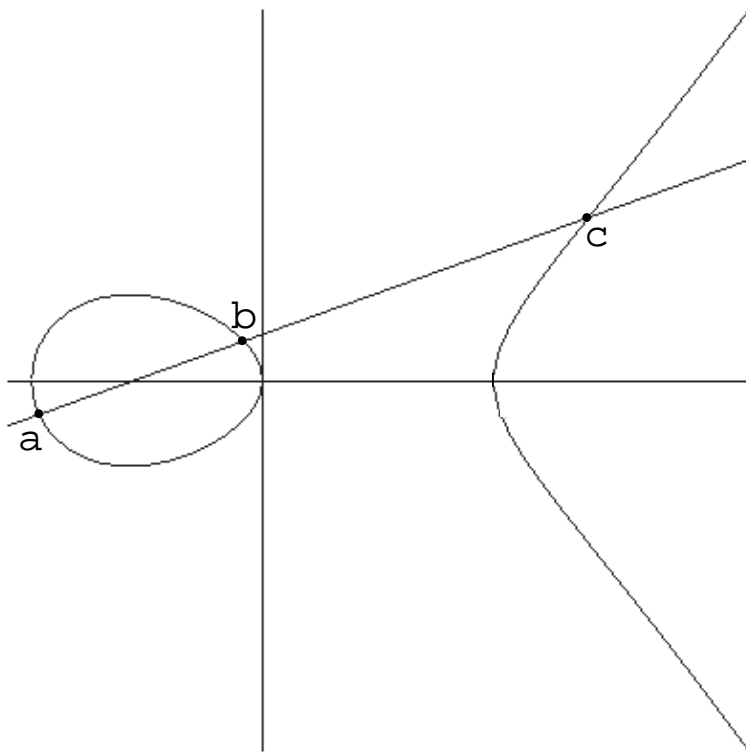

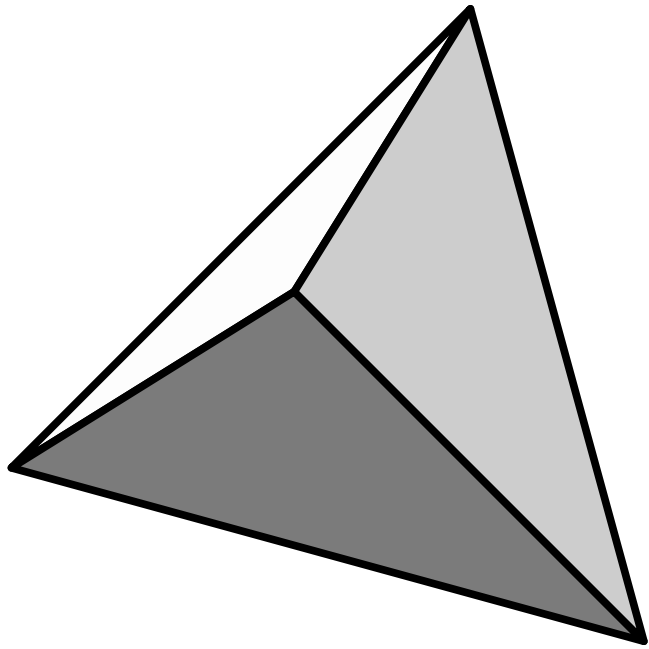

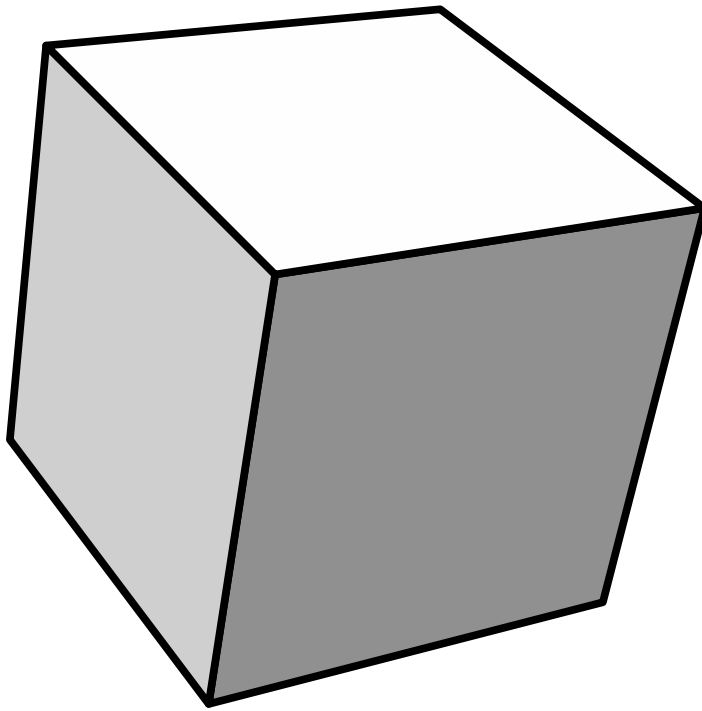

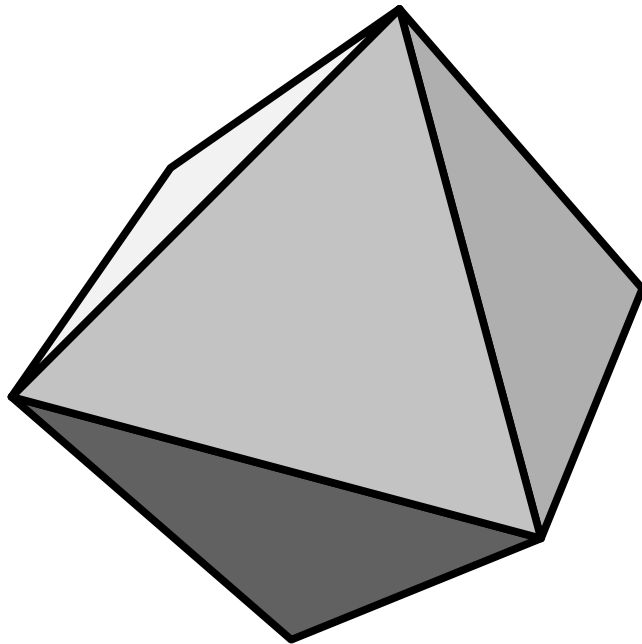

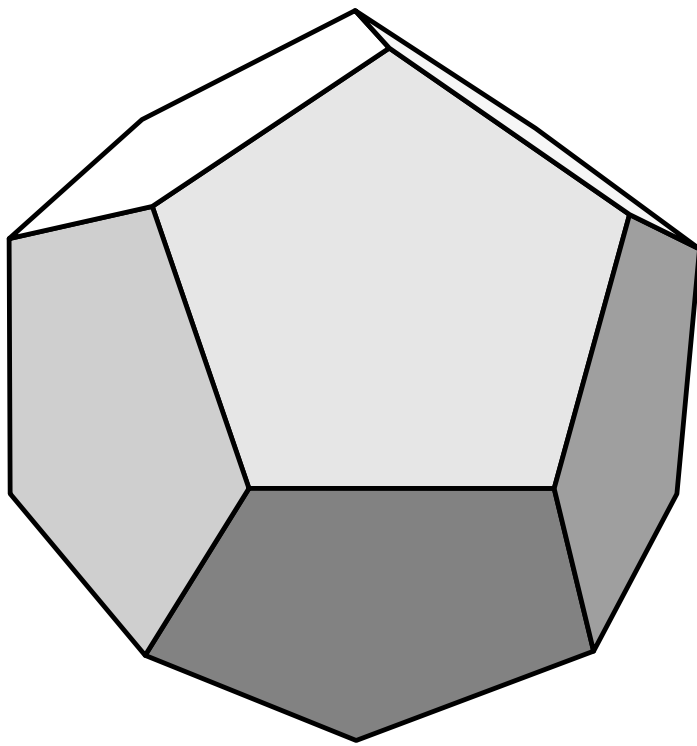

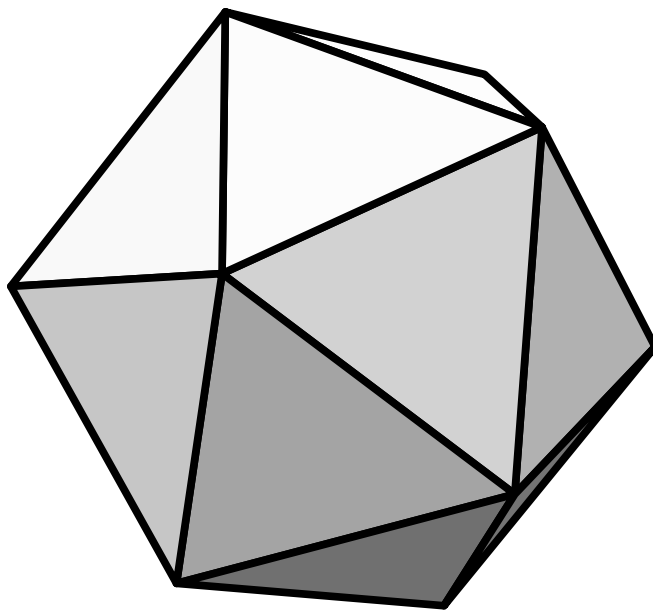

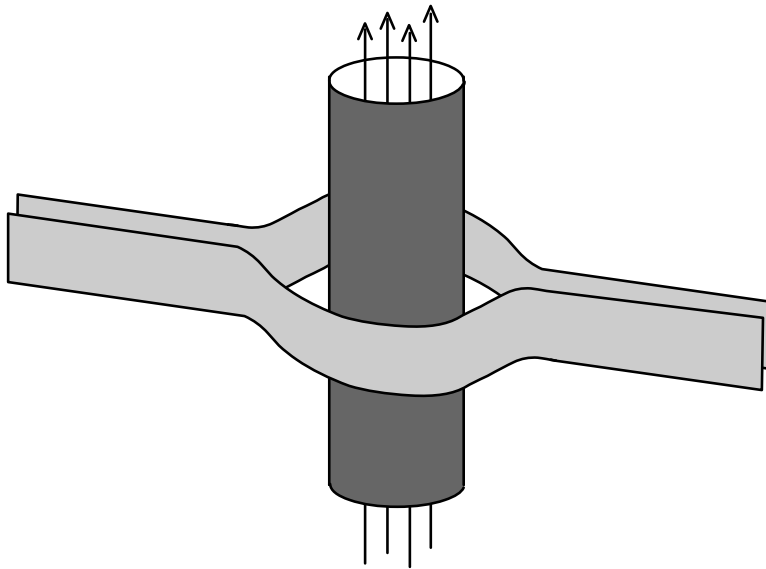
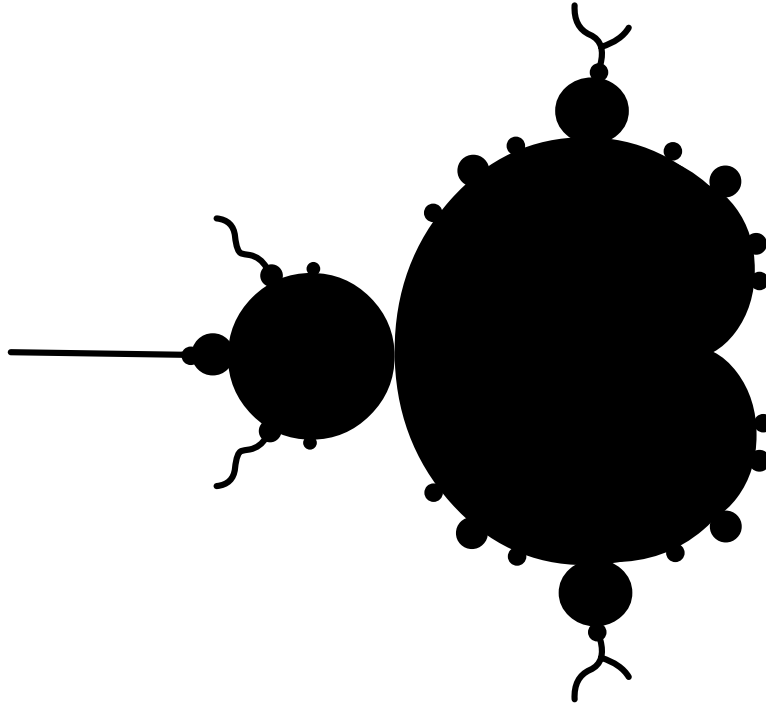

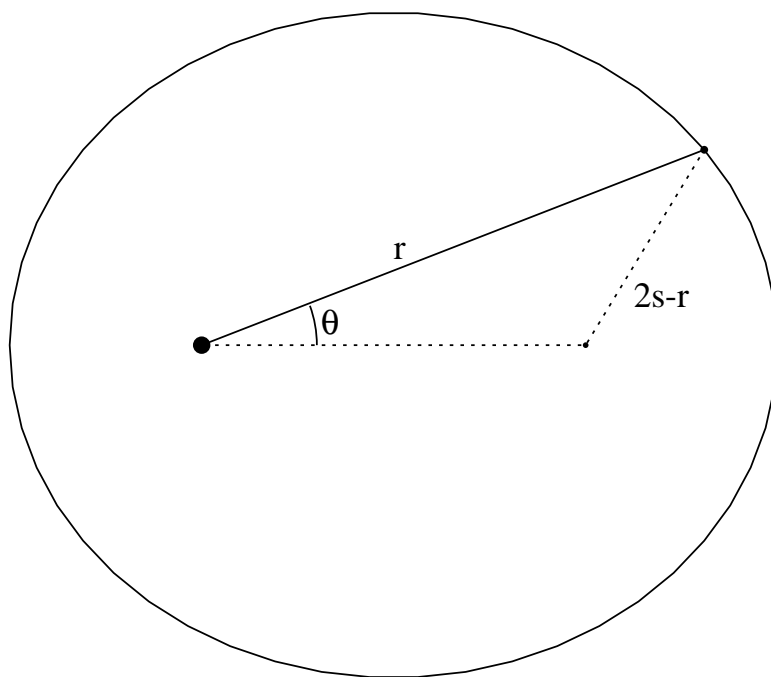
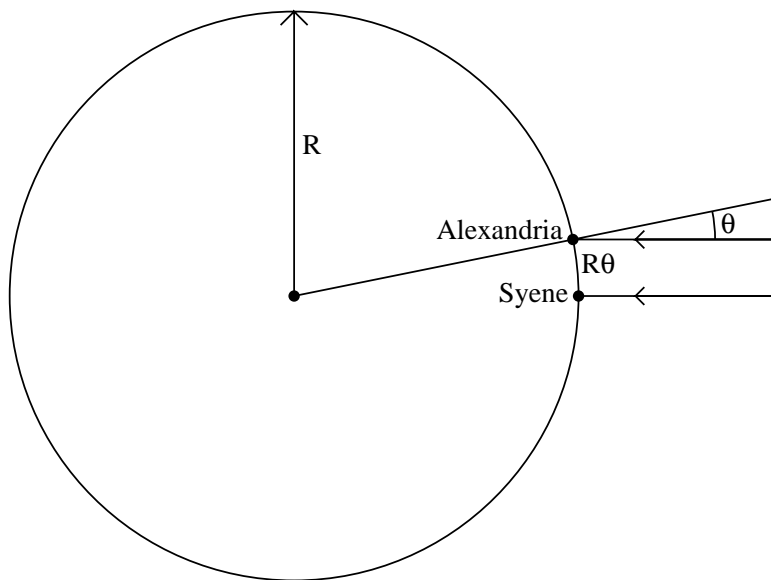

$$r \frac{d\theta}{dt} = \text{constant}, \quad \oint dt \propto s^{3/2}$$