

*Mass, Scalar Curvature,
Kähler Geometry, and All That*

Claude LeBrun
Stony Brook University

Colloquium di Matematica
Università degli Studi Roma Tre
Dipartimento di Matematica e Fisica
22 maggio, 2019

Core results joint with

Core results joint with

Hans-Joachim Hein
Fordham University

Core results joint with

Hans-Joachim Hein
Fordham University

Mass in Kähler Geometry
Comm. Math. Phys. 347 (2016) 621–653.

Recent technical improvements:

Recent technical improvements:

Mass, Kähler Manifolds,
and Symplectic Geometry

Recent technical improvements:

Mass, Kähler Manifolds,
and Symplectic Geometry

arXiv: 1810.11417 [math.DG]

Recent technical improvements:

Mass, Kähler Manifolds,
and Symplectic Geometry

arXiv: 1810.11417 [math.DG]

Ann. Glob. An. Geom. to appear

doi: 10.1007/s10455-019-09658-9

Let (M^n, g) be a Riemannian n -manifold, $p \in M$.

Let (M^n, g) be a Riemannian n -manifold, $p \in M$.
Metric defines locally shortest curves, called *geodesics*.
Following geodesics from p defines a map

$$\exp : T_p M \rightarrow M$$

Let (M^n, g) be a Riemannian n -manifold, $p \in M$.
Metric defines locally shortest curves, called *geodesics*.
Following geodesics from p defines a map

$$\exp : T_p M \rightarrow M$$

which is a diffeomorphism on a neighborhood of 0:

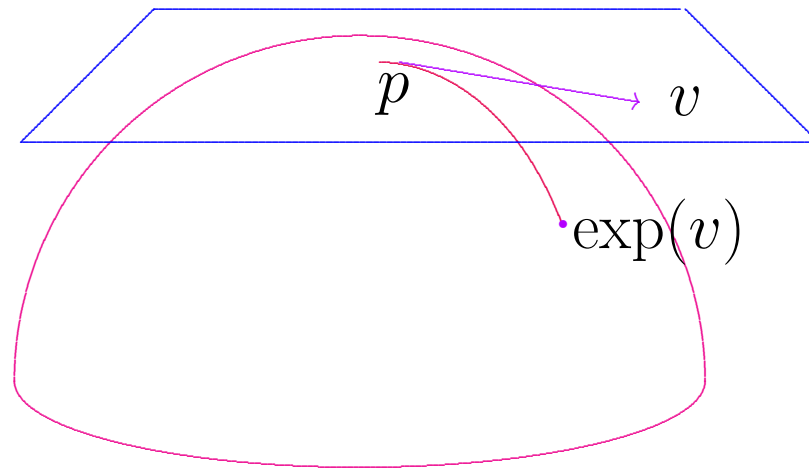

Let (M^n, g) be a Riemannian n -manifold, $p \in M$.
Metric defines locally shortest curves, called *geodesics*.
Following geodesics from p defines a map

$$\exp : T_p M \rightarrow M$$

which is a diffeomorphism on a neighborhood of 0:

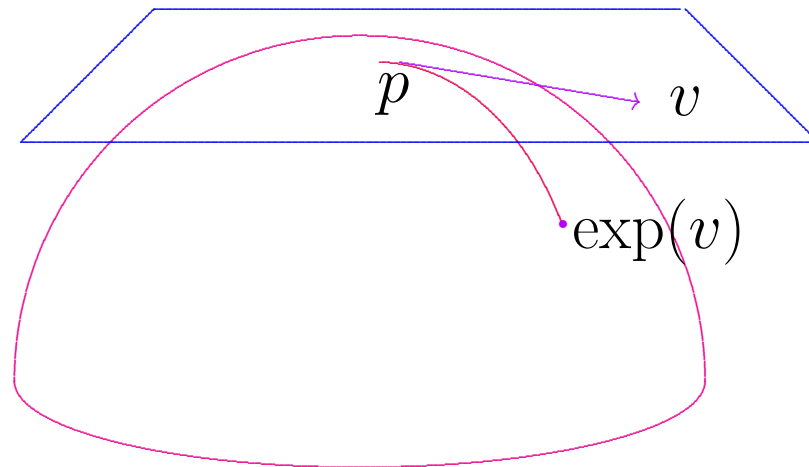

Now choosing $T_p M \xrightarrow{\cong} \mathbb{R}^n$ via some orthonormal
basis gives us special coordinates on M .

In these “geodesic normal” coordinates, the metric

In these “geodesic normal” coordinates, the metric has components given by

$$g_{jk} =$$

In these “geodesic normal” coordinates, the metric has components given by

$$g_{jk} = \delta_{jk}$$

In these “geodesic normal” coordinates, the metric has components given by

$$g_{jk} = \delta_{jk} - \frac{1}{3} \mathcal{R}_{j\ell km} x^\ell x^m$$

In these “geodesic normal” coordinates, the metric has components given by

$$g_{jk} = \delta_{jk} - \frac{1}{3} \mathcal{R}_{j\ell km} x^\ell x^m + O(|x|^3)$$

In these “geodesic normal” coordinates, the metric has components given by

$$g_{jk} = \delta_{jk} - \frac{1}{3} \mathcal{R}_{j\ell km} x^\ell x^m + O(|x|^3)$$

where the $\mathcal{R}_{j\ell km}$ are exactly the components of the Riemann curvature tensor

In these “geodesic normal” coordinates, the metric has components given by

$$g_{jk} = \delta_{jk} - \frac{1}{3} \mathcal{R}_{j\ell km} x^\ell x^m + O(|x|^3)$$

where the $\mathcal{R}_{j\ell km}$ are exactly the components of the **Riemann curvature tensor** at the reference point p represented by $\vec{x} = 0$ in these coordinates.

In these “geodesic normal” coordinates, the metric has components given by

$$g_{jk} = \delta_{jk} - \frac{1}{3} \mathcal{R}_{j\ell km} x^\ell x^m + O(|x|^3)$$

where the $\mathcal{R}_{j\ell km}$ are exactly the components of the **Riemann curvature tensor** at the reference point p represented by $\vec{x} = 0$ in these coordinates.

Uniquely determined

In these “geodesic normal” coordinates, the metric has components given by

$$g_{jk} = \delta_{jk} - \frac{1}{3} \mathcal{R}_{j\ell km} x^\ell x^m + O(|x|^3)$$

where the $\mathcal{R}_{j\ell km}$ are exactly the components of the Riemann curvature tensor at the reference point p represented by $\vec{x} = 0$ in these coordinates.

Uniquely determined by the above expression for g_{jk}

In these “geodesic normal” coordinates, the metric has components given by

$$g_{jk} = \delta_{jk} - \frac{1}{3} \mathcal{R}_{j\ell km} x^\ell x^m + O(|x|^3)$$

where the $\mathcal{R}_{j\ell km}$ are exactly the components of the **Riemann curvature tensor** at the reference point p represented by $\vec{x} = 0$ in these coordinates.

Uniquely determined by the above expression for g_{jk} once one also requires **Bianchi identities**

In these “geodesic normal” coordinates, the metric has components given by

$$g_{jk} = \delta_{jk} - \frac{1}{3} \mathcal{R}_{j\ell km} x^\ell x^m + O(|x|^3)$$

where the $\mathcal{R}_{j\ell km}$ are exactly the components of the **Riemann curvature tensor** at the reference point p represented by $\vec{x} = 0$ in these coordinates.

Uniquely determined by the above expression for g_{jk} once one also requires **Bianchi identities**

$$\mathcal{R}_{j\ell km} = -\mathcal{R}_{\ell jkm} = -\mathcal{R}_{j\ell mk}$$

In these “geodesic normal” coordinates, the metric has components given by

$$g_{jk} = \delta_{jk} - \frac{1}{3} \mathcal{R}_{j\ell km} x^\ell x^m + O(|x|^3)$$

where the $\mathcal{R}_{j\ell km}$ are exactly the components of the **Riemann curvature tensor** at the reference point p represented by $\vec{x} = 0$ in these coordinates.

Uniquely determined by the above expression for g_{jk} once one also requires **Bianchi identities**

$$\mathcal{R}_{j\ell km} = -\mathcal{R}_{\ell j km} = -\mathcal{R}_{j\ell mk}$$

$$\mathcal{R}_{j\ell km} + \mathcal{R}_{jkml} + \mathcal{R}_{jm\ell k} = 0$$

In these “geodesic normal” coordinates, the metric has components given by

$$g_{jk} = \delta_{jk} - \frac{1}{3} \mathcal{R}_{j\ell km} x^\ell x^m + O(|x|^3)$$

where the $\mathcal{R}_{j\ell km}$ are exactly the components of the **Riemann curvature tensor** at the reference point p represented by $\vec{x} = 0$ in these coordinates.

Uniquely determined by the above expression for g_{jk} once one also requires **Bianchi identities**

$$\mathcal{R}_{j\ell km} = -\mathcal{R}_{\ell j km} = -\mathcal{R}_{j\ell mk}$$

$$\mathcal{R}_{j\ell km} + \mathcal{R}_{jkml} + \mathcal{R}_{jm\ell k} = 0$$

Components like \mathcal{R}_{1212} are “**sectional curvatures**” ...

More conceptually, the *sectional curvature*

More conceptually, the *sectional curvature*

$$K : Gr_2 TM \rightarrow \mathbb{R}$$

More conceptually, the *sectional curvature*

$$K : Gr_2 TM \rightarrow \mathbb{R}$$

compares distances to the Euclidean answer:

More conceptually, the *sectional curvature*

$$K : Gr_2 TM \rightarrow \mathbb{R}$$

compares distances to the Euclidean answer:

$$\frac{\text{length}_g(\text{base of isosceles triangle})}{\text{Euclidean answer}} \approx 1 - K(\Pi) \frac{\varepsilon^2}{6} + O(\varepsilon^3)$$

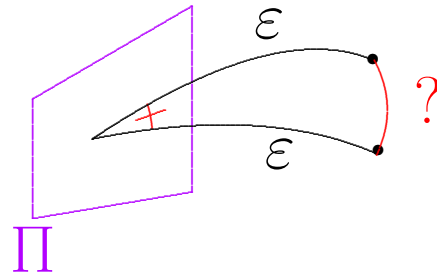

More conceptually, the *sectional curvature*

$$K : Gr_2 TM \rightarrow \mathbb{R}$$

compares distances to the Euclidean answer:

$$\frac{\text{length}_g(\text{base of isosceles triangle})}{\text{Euclidean answer}} \approx 1 - K(\Pi) \frac{\varepsilon^2}{6} + O(\varepsilon^3)$$

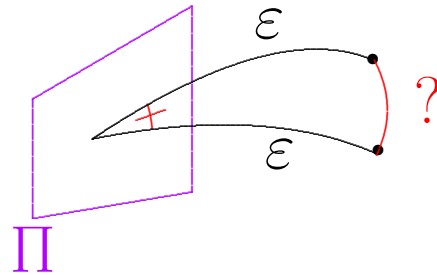

The metric g is called *flat* if it satisfies $K \equiv 0$.

More conceptually, the *sectional curvature*

$$K : Gr_2 TM \rightarrow \mathbb{R}$$

compares distances to the Euclidean answer:

$$\frac{\text{length}_g(\text{base of isosceles triangle})}{\text{Euclidean answer}} \approx 1 - K(\Pi) \frac{\varepsilon^2}{6} + O(\varepsilon^3)$$

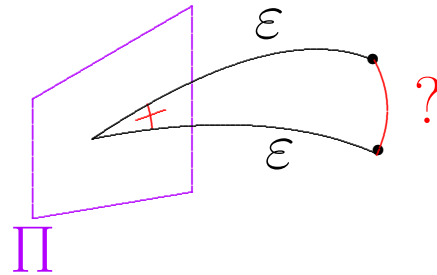

The metric g is called *flat* if it satisfies $K \equiv 0$.

$\iff g_{jk} = \delta_{jk}$ in suitable coordinates.

More conceptually, the *sectional curvature*

$$K : Gr_2 TM \rightarrow \mathbb{R}$$

compares distances to the Euclidean answer:

$$\frac{\text{length}_g(\text{base of isosceles triangle})}{\text{Euclidean answer}} \approx 1 - K(\Pi) \frac{\varepsilon^2}{6} + O(\varepsilon^3)$$

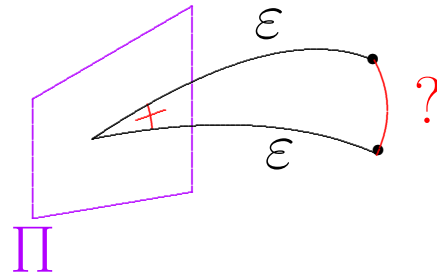

The metric g is called *flat* if it satisfies $K \equiv 0$.

Similarly, in geodesic normal coordinates the metric volume measure is given by

$$d\mu_g = d\mu_{\text{Euclidean}},$$

Similarly, in geodesic normal coordinates the metric volume measure is given by

$$d\mu_g = \left[1 - \frac{1}{6} R_{ij} x^i x^j + \frac{1}{120} R_{ijkl} x^i x^j x^k x^l - \dots \right] d\mu_{\text{Euclidean}},$$

Similarly, in geodesic normal coordinates the metric volume measure is given by

$$d\mu_g = \left[1 - \frac{1}{6} r_{jk} x^j x^k + \right] d\mu_{\text{Euclidean}},$$

Similarly, in geodesic normal coordinates the metric volume measure is given by

$$d\mu_g = \left[1 - \frac{1}{6} r_{jk} x^j x^k + O(|x|^3) \right] d\mu_{\text{Euclidean}},$$

Similarly, in geodesic normal coordinates the metric volume measure is given by

$$d\mu_g = \left[1 - \frac{1}{6} r_{jk} x^j x^k + O(|x|^3) \right] d\mu_{\text{Euclidean}},$$

where r is the *Ricci tensor*

Similarly, in geodesic normal coordinates the metric volume measure is given by

$$d\mu_g = \left[1 - \frac{1}{6} r_{jk} x^j x^k + O(|x|^3) \right] d\mu_{\text{Euclidean}},$$

where r is the *Ricci tensor* $r_{jk} = \mathcal{R}^i_{jik}$.

Similarly, in geodesic normal coordinates the metric volume measure is given by

$$d\mu_g = \left[1 - \frac{1}{6} r_{jk} x^j x^k + O(|x|^3) \right] d\mu_{\text{Euclidean}},$$

where r is the *Ricci tensor* $r_{jk} = \mathcal{R}^i_{jik}$.

$$d\mu_g = \sqrt{\det[g_{jk}]} dx^1 \wedge \cdots \wedge dx^n$$

Similarly, in geodesic normal coordinates the metric volume measure is given by

$$d\mu_g = \left[1 - \frac{1}{6} r_{jk} x^j x^k + O(|x|^3) \right] d\mu_{\text{Euclidean}},$$

where r is the *Ricci tensor* $r_{jk} = \mathcal{R}^i_{jik}$.

More conceptually, the *Ricci curvature*

$$r : UTM \rightarrow \mathbb{R}$$

is a standard Riemannian invariant comparing the volume of narrow cones to the Euclidean answer:

More conceptually, the *Ricci curvature*

$$r : UTM \rightarrow \mathbb{R}$$

is a standard Riemannian invariant comparing the volume of narrow cones to the Euclidean answer:

$$\frac{\text{vol}_g(C_\varepsilon(p, v, \Omega))}{\text{Euclidean answer}} \approx 1 - r(v) \frac{n\varepsilon^2}{6(n+2)} + O(\varepsilon^3)$$

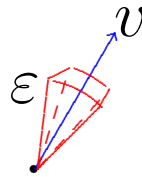

More conceptually, the *Ricci curvature*

$$r : UTM \rightarrow \mathbb{R}$$

is a standard Riemannian invariant comparing the volume of narrow cones to the Euclidean answer:

$$\frac{\text{vol}_g(C_\varepsilon(p, v, \Omega))}{\text{Euclidean answer}} \approx 1 - r(v, v) \frac{n\varepsilon^2}{6(n+2)} + O(\varepsilon^3)$$

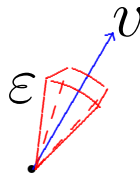

More conceptually, the *Ricci curvature*

$$r : UTM \rightarrow \mathbb{R}$$

is a standard Riemannian invariant comparing the volume of narrow cones to the Euclidean answer:

$$\frac{\text{vol}_g(C_\varepsilon(p, v, \Omega))}{\text{Euclidean answer}} \approx 1 - r(v) \frac{n\varepsilon^2}{6(n+2)} + O(\varepsilon^3)$$

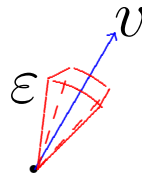

The metric g is called *Ricci-flat* if it satisfies $r \equiv 0$.

The *scalar curvature* is usually next defined to be the trace of the Ricci tensor:

The *scalar curvature* is usually next defined to be the trace of the Ricci tensor:

$$s = r_j^j = \mathcal{R}^{ij}_{ij}.$$

The *scalar curvature* is usually next defined to be the trace of the Ricci tensor:

$$s = r_j^j = \mathcal{R}^{ij}_{ij}.$$

But this has a simple geometric interpretation...

Conceptually, the *scalar curvature* of (M^n, g)

Conceptually, the *scalar curvature* of (M^n, g)

$$s : M \rightarrow \mathbb{R}$$

Conceptually, the *scalar curvature* of (M^n, g)

$$s : M \rightarrow \mathbb{R}$$

arises by comparing the volume of small balls to the Euclidean answer:

Conceptually, the *scalar curvature* of (M^n, g)

$$s : M \rightarrow \mathbb{R}$$

arises by comparing the volume of small balls to the Euclidean answer:

$$\frac{\text{vol}_g(B_\varepsilon(p))}{\text{Euclidean answer}} = 1 - s(p) \frac{\varepsilon^2}{6(n+2)} + O(\varepsilon^4)$$

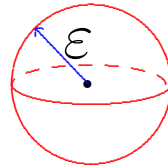

Conceptually, the *scalar curvature* of (M^n, g)

$$s : M \rightarrow \mathbb{R}$$

arises by comparing the volume of small balls to the Euclidean answer:

$$\frac{\text{vol}_g(B_\varepsilon(p))}{\text{Euclidean answer}} = 1 - s(p) \frac{\varepsilon^2}{6(n+2)} + O(\varepsilon^4)$$

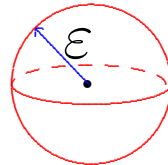

The metric g is called *scalar-flat* if it satisfies $s \equiv 0$.

Simple, natural problem:

Simple, natural problem:

(M^n, g) complete non-compact Riemannian n -manifold.

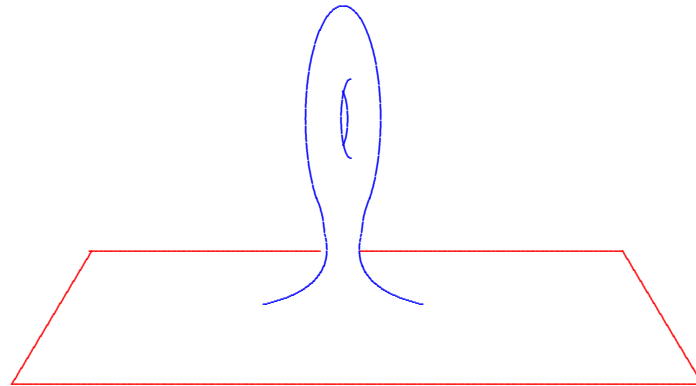

Simple, natural problem:

(M^n, g) complete non-compact Riemannian n -manifold.

Suppose $\exists K \subset M$ compact

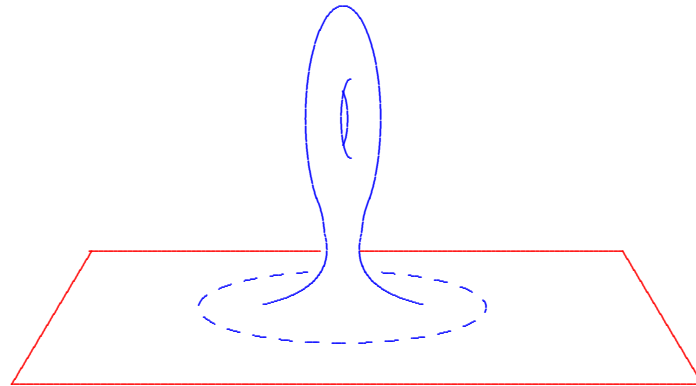

Simple, natural problem:

(M^n, g) complete non-compact Riemannian n -manifold.

Suppose $\exists K \subset M$ compact

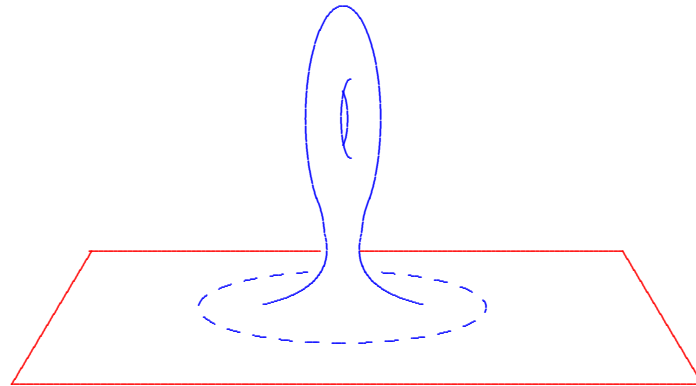

and an isometry $M - K \rightarrow \mathbb{R}^n - D^n$. (Euclidean)

Simple, natural problem:

(M^n, g) complete non-compact Riemannian n -manifold.

Suppose $\exists K \subset M$ compact

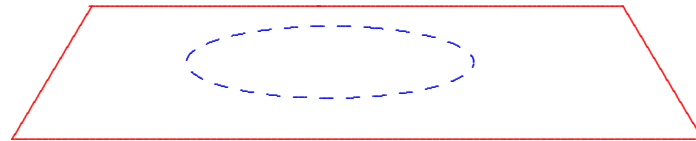

and an isometry $M - K \rightarrow \mathbb{R}^n - D^n$. (Euclidean)

Simple, natural problem:

(M^n, g) complete non-compact Riemannian n -manifold.

Suppose $\exists K \subset M$ compact

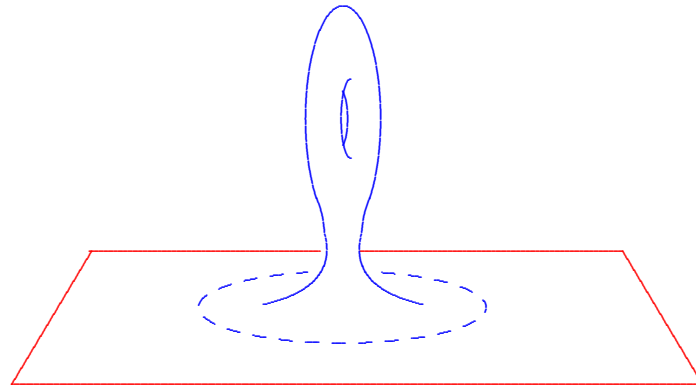

and an isometry $M - K \rightarrow \mathbb{R}^n - D^n$. (Euclidean)

Simple, natural problem:

(M^n, g) complete non-compact Riemannian n -manifold.

Suppose $\exists K \subset M$ compact

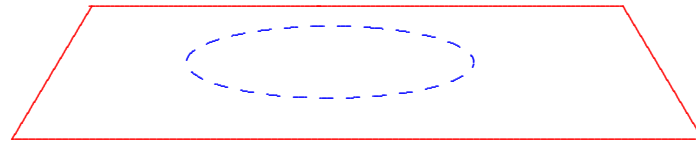

and an isometry $M - K \rightarrow \mathbb{R}^n - D^n$. (Euclidean)

Simple, natural problem:

(M^n, g) complete non-compact Riemannian n -manifold.

Suppose $\exists K \subset M$ compact

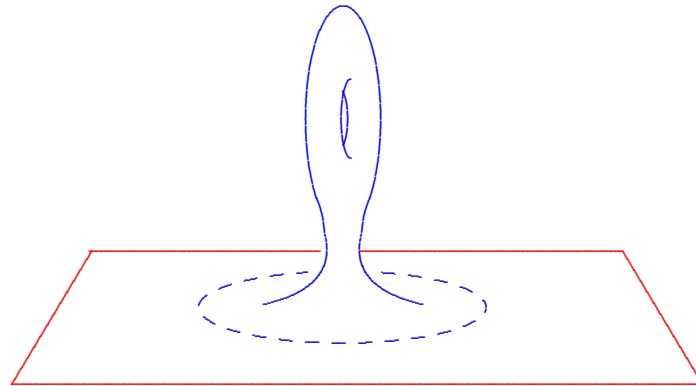

and an isometry $M - K \rightarrow \mathbb{R}^n - D^n$. (Euclidean)

Simple, natural problem:

(M^n, g) complete non-compact Riemannian n -manifold.

Suppose $\exists K \subset M$ compact

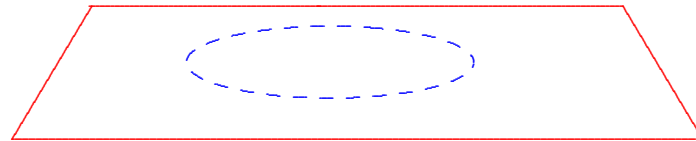

and an isometry $M - K \rightarrow \mathbb{R}^n - D^n$. (Euclidean)

Simple, natural problem:

(M^n, g) complete non-compact Riemannian n -manifold.

Suppose $\exists K \subset M$ compact

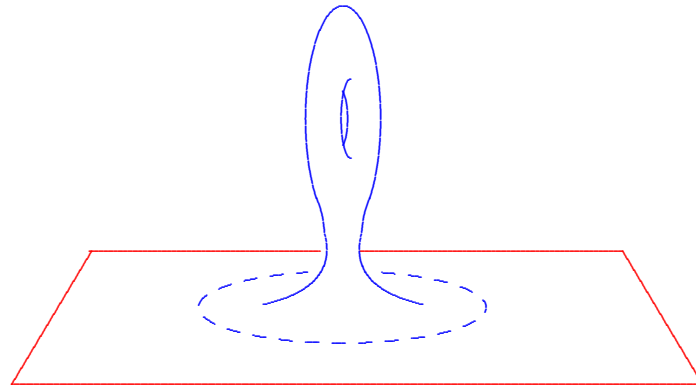

and an isometry $M - K \rightarrow \mathbb{R}^n - D^n$. (Euclidean)

Simple, natural problem:

(M^n, g) complete non-compact Riemannian n -manifold.

Suppose $\exists K \subset M$ compact

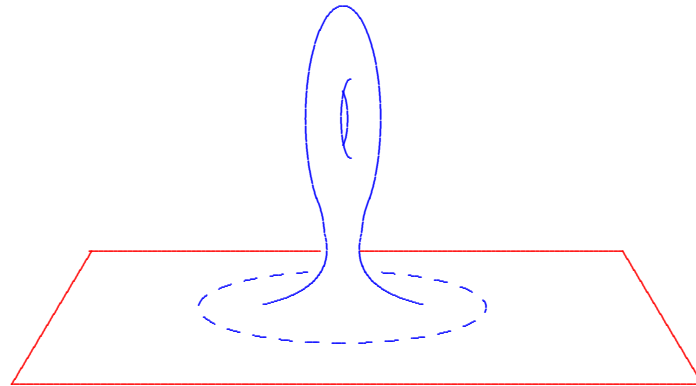

and an isometry $M - K \rightarrow \mathbb{R}^n - D^n$. (Euclidean)

If M has curvature ≥ 0 , is it flat?

Simple, natural problem:

(M^n, g) complete non-compact Riemannian n -manifold.

Suppose $\exists K \subset M$ compact

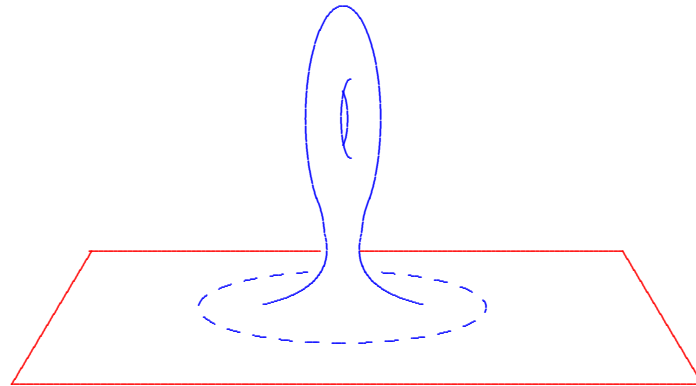

and an isometry $M - K \rightarrow \mathbb{R}^n - D^n$. (Euclidean)

If M has sectional curvature ≥ 0 , is it flat?

Simple, natural problem:

(M^n, g) complete non-compact Riemannian n -manifold.

Suppose $\exists K \subset M$ compact

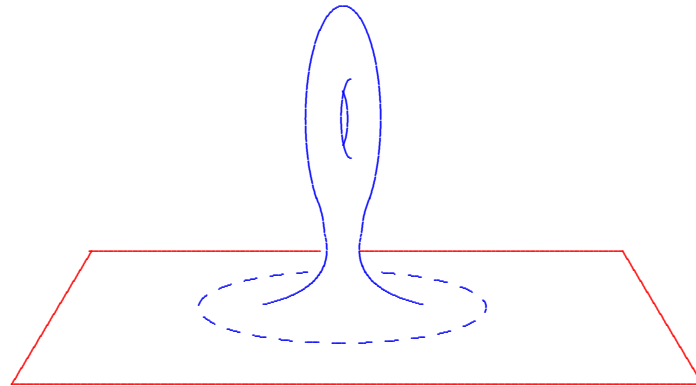

and an isometry $M - K \rightarrow \mathbb{R}^n - D^n$. (Euclidean)

If M has sectional curvature ≥ 0 , is it flat? Yes!

Simple, natural problem:

(M^n, g) complete non-compact Riemannian n -manifold.

Suppose $\exists K \subset M$ compact

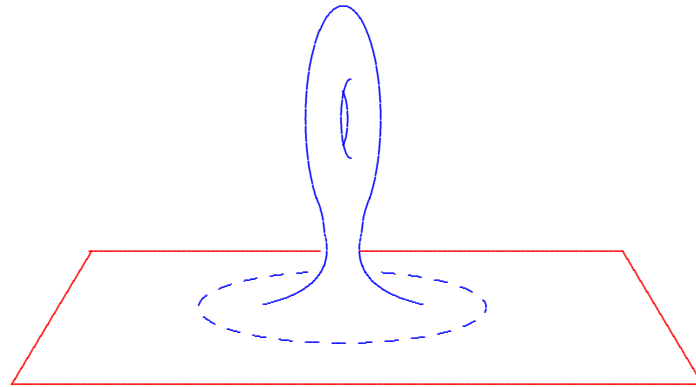

and an isometry $M - K \rightarrow \mathbb{R}^n - D^n$. (Euclidean)

If M has sectional curvature ≥ 0 , is it flat? Yes!

Distance comparison...

Simple, natural problem:

(M^n, g) complete non-compact Riemannian n -manifold.

Suppose $\exists K \subset M$ compact

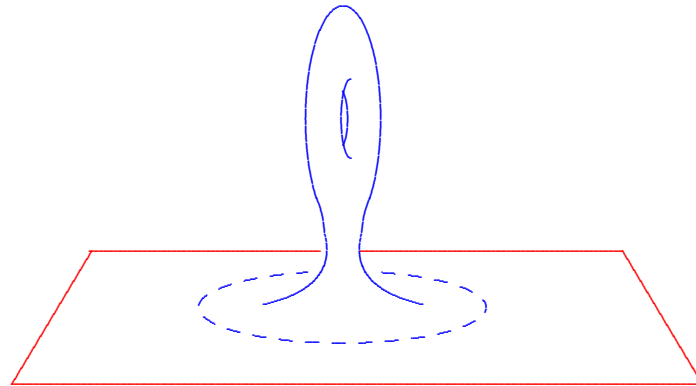

and an isometry $M - K \rightarrow \mathbb{R}^n - D^n$. (Euclidean)

If M has curvature ≥ 0 , is it flat?

Simple, natural problem:

(M^n, g) complete non-compact Riemannian n -manifold.

Suppose $\exists K \subset M$ compact

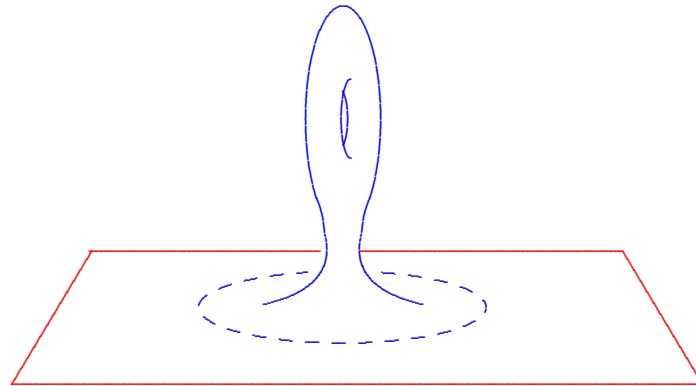

and an isometry $M - K \rightarrow \mathbb{R}^n - D^n$. (Euclidean)

If M has Ricci curvature ≥ 0 , is it flat?

Simple, natural problem:

(M^n, g) complete non-compact Riemannian n -manifold.

Suppose $\exists K \subset M$ compact

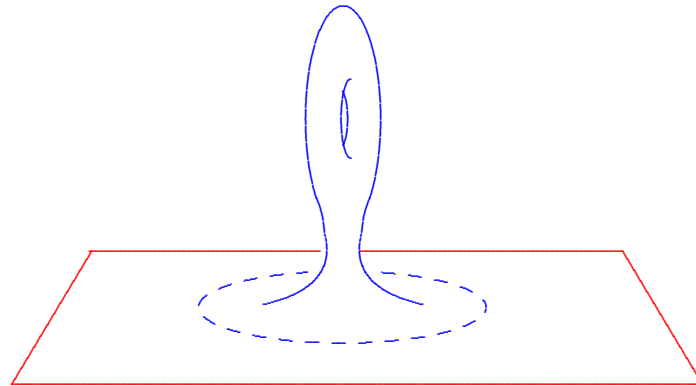

and an isometry $M - K \rightarrow \mathbb{R}^n - D^n$. (Euclidean)

If M has Ricci curvature ≥ 0 , is it flat? Yes!

Simple, natural problem:

(M^n, g) complete non-compact Riemannian n -manifold.

Suppose $\exists K \subset M$ compact

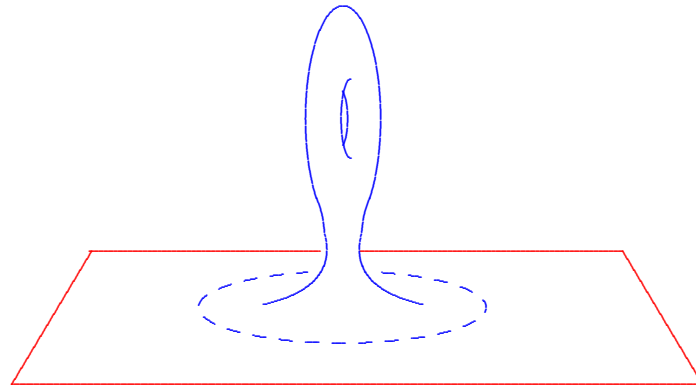

and an isometry $M - K \rightarrow \mathbb{R}^n - D^n$. (Euclidean)

If M has Ricci curvature ≥ 0 , is it flat? Yes!

Volume comparison...

Simple, natural problem:

(M^n, g) complete non-compact Riemannian n -manifold.

Suppose $\exists K \subset M$ compact

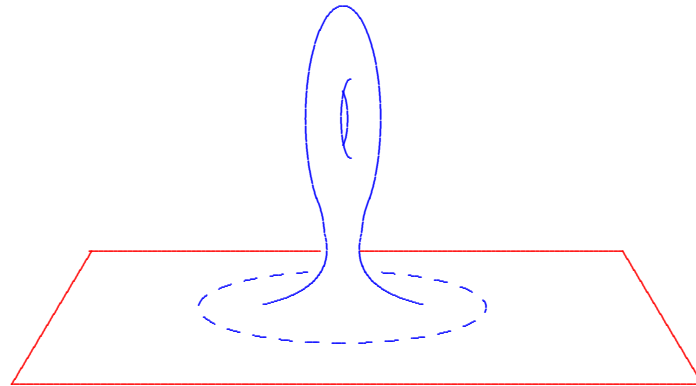

and an isometry $M - K \rightarrow \mathbb{R}^n - D^n$. (Euclidean)

If M has curvature ≥ 0 , is it flat?

Simple, natural problem:

(M^n, g) complete non-compact Riemannian n -manifold.

Suppose $\exists K \subset M$ compact

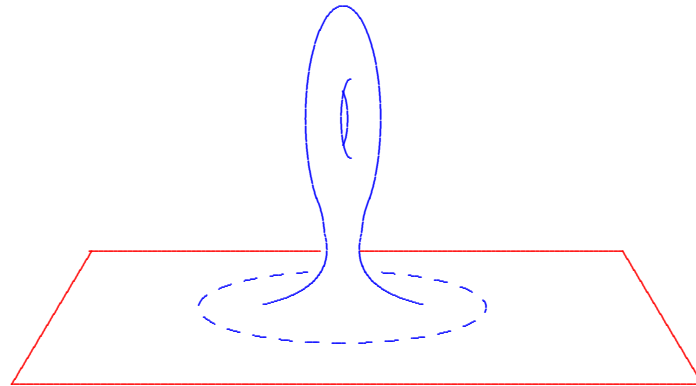

and an isometry $M - K \rightarrow \mathbb{R}^n - D^n$. (Euclidean)

If M has scalar curvature ≥ 0 , is it flat?

Simple, natural problem:

(M^n, g) complete non-compact Riemannian n -manifold.

Suppose $\exists K \subset M$ compact

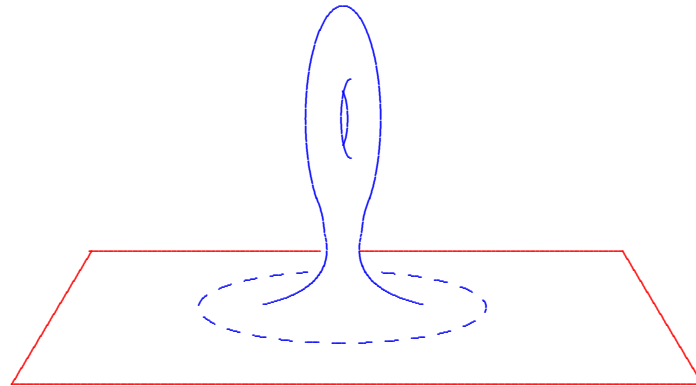

and an isometry $M - K \rightarrow \mathbb{R}^n - D^n$. (Euclidean)

If M has scalar curvature ≥ 0 , is it flat?

Much harder!

Simple, natural problem:

(M^n, g) complete non-compact Riemannian n -manifold.

Suppose $\exists K \subset M$ compact

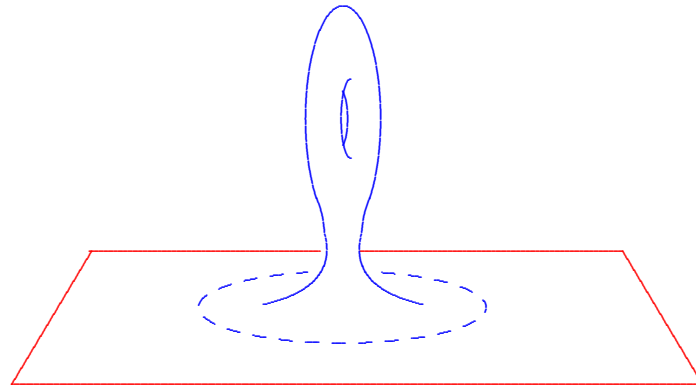

and an isometry $M - K \rightarrow \mathbb{R}^n - D^n$. (Euclidean)

If M has scalar curvature ≥ 0 , is it flat? Yes!

Simple, natural problem:

(M^n, g) complete non-compact Riemannian n -manifold.

Suppose $\exists K \subset M$ compact

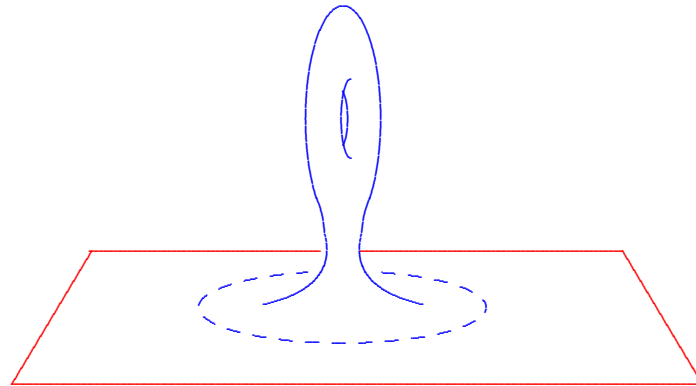

and an isometry $M - K \rightarrow \mathbb{R}^n - D^n$. (Euclidean)

If M has scalar curvature ≥ 0 , is it flat? Yes!

This time, the inspiration comes from physics!

Simple, natural problem:

(M^n, g) complete non-compact Riemannian n -manifold.

Suppose $\exists K \subset M$ compact

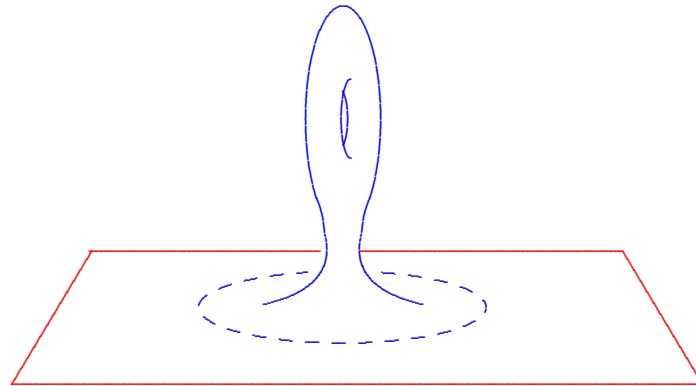

and an isometry $M - K \rightarrow \mathbb{R}^n - D^n$. (Euclidean)

If M has scalar curvature ≥ 0 , is it flat? Yes!

“Positive Mass Theorem”

Simple, natural problem:

(M^n, g) complete non-compact Riemannian n -manifold.

Suppose $\exists K \subset M$ compact

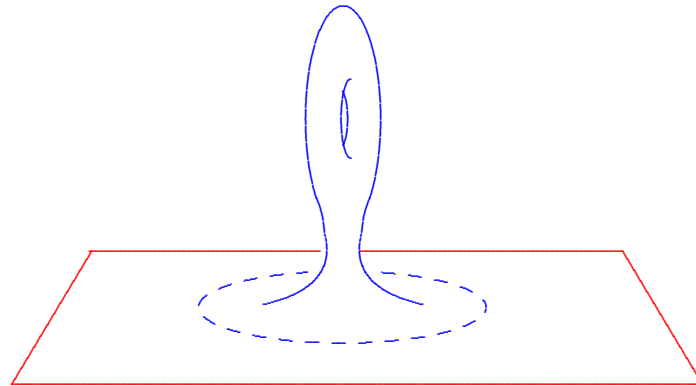

and an isometry $M - K \rightarrow \mathbb{R}^n - D^n$. (Euclidean)

If M has scalar curvature ≥ 0 , is it flat? Yes!

“Positive Mass Theorem”

Get result even with appropriate fall-off to Euclidean...

Definition. A complete, non-compact Riemannian n -manifold (M^n, g)

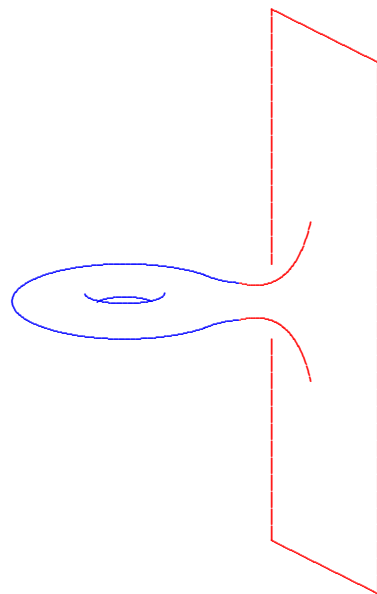

Definition. A complete, non-compact Riemannian n -manifold (M^n, g)

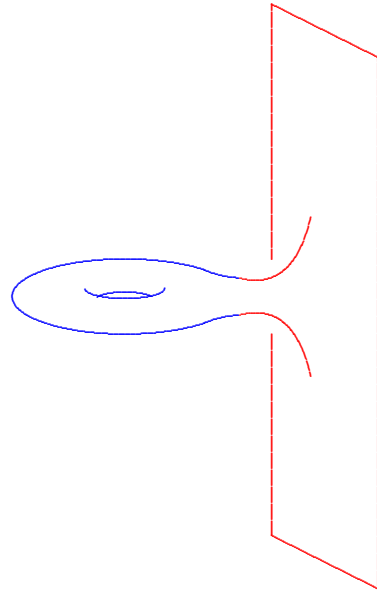

$$n \geq 3$$

Definition. A complete, non-compact Riemannian n -manifold (M^n, g) is called asymptotically Euclidean

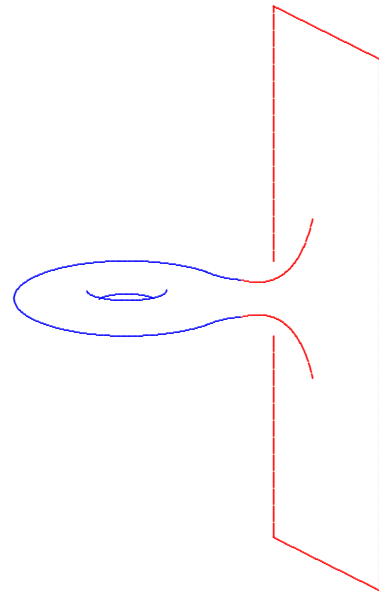

$$n \geq 3$$

Definition. A complete, non-compact Riemannian n -manifold (M^n, g) is called asymptotically Euclidean (AE)

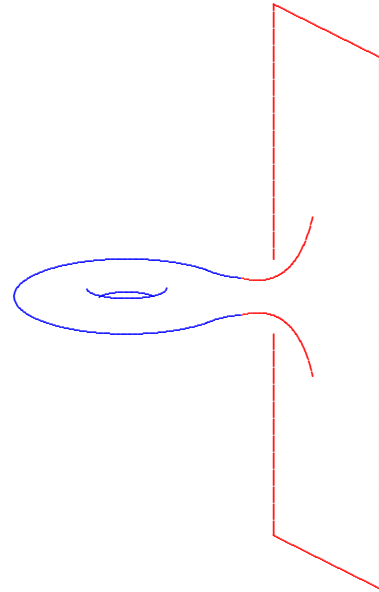

$$n \geq 3$$

Definition. A complete, non-compact Riemannian n -manifold (M^n, g) is called **asymptotically Euclidean (AE)** if there is a compact set $K \subset M$

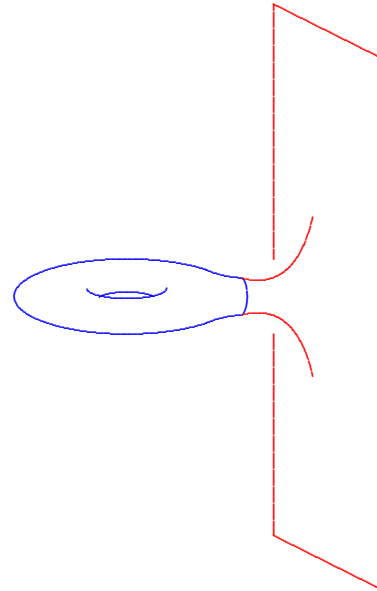

Definition. A complete, non-compact Riemannian n -manifold (M^n, g) is called **asymptotically Euclidean (AE)** if there is a compact set $K \subset M$ such that $M - K$ is diffeomorphic to $\mathbb{R}^n - D^n$

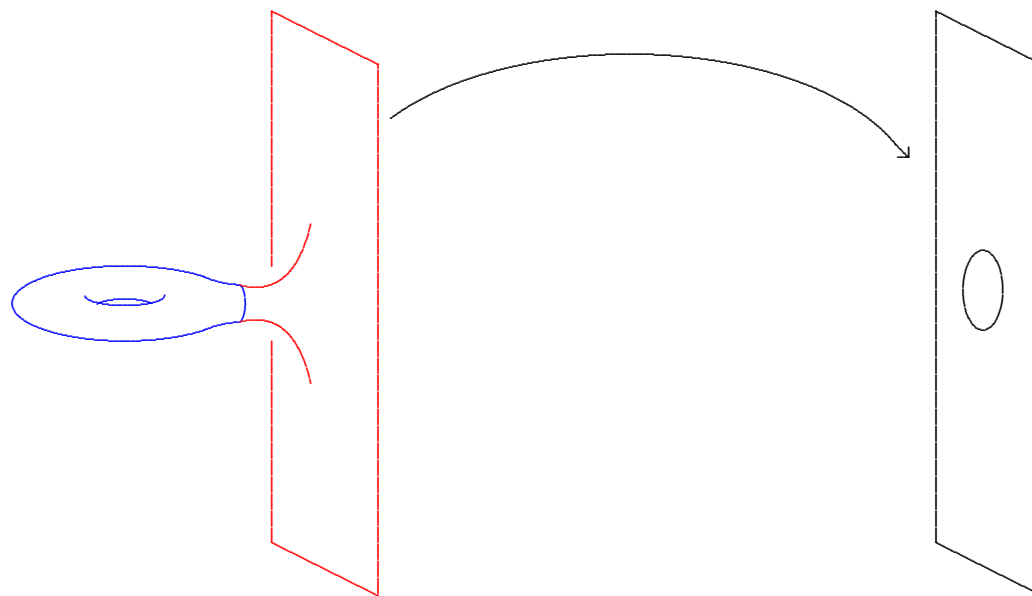

Definition. A complete, non-compact Riemannian n -manifold (M^n, g) is called **asymptotically Euclidean (AE)** if there is a compact set $K \subset M$ such that $M - K$ is diffeomorphic to $\mathbb{R}^n - D^n$ in such a manner that

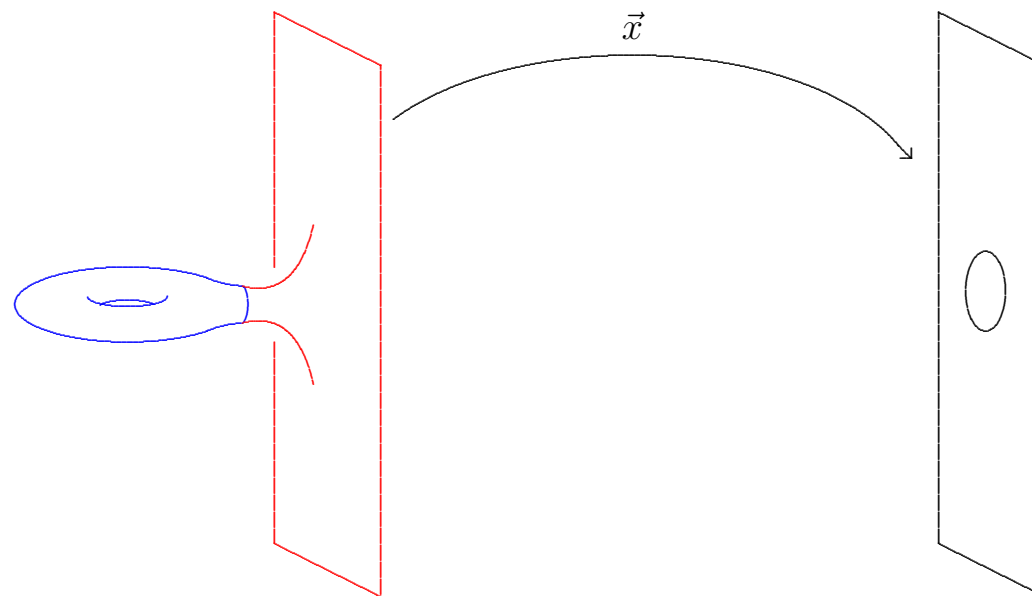

$$g_{jk} = \delta_{jk} + \text{terms that fall-off at infinity}$$

Definition. A complete, non-compact Riemannian n -manifold (M^n, g) is called **asymptotically Euclidean (AE)** if there is a compact set $K \subset M$ such that $M - K$ is diffeomorphic to $\mathbb{R}^n - D^n$ in such a manner that

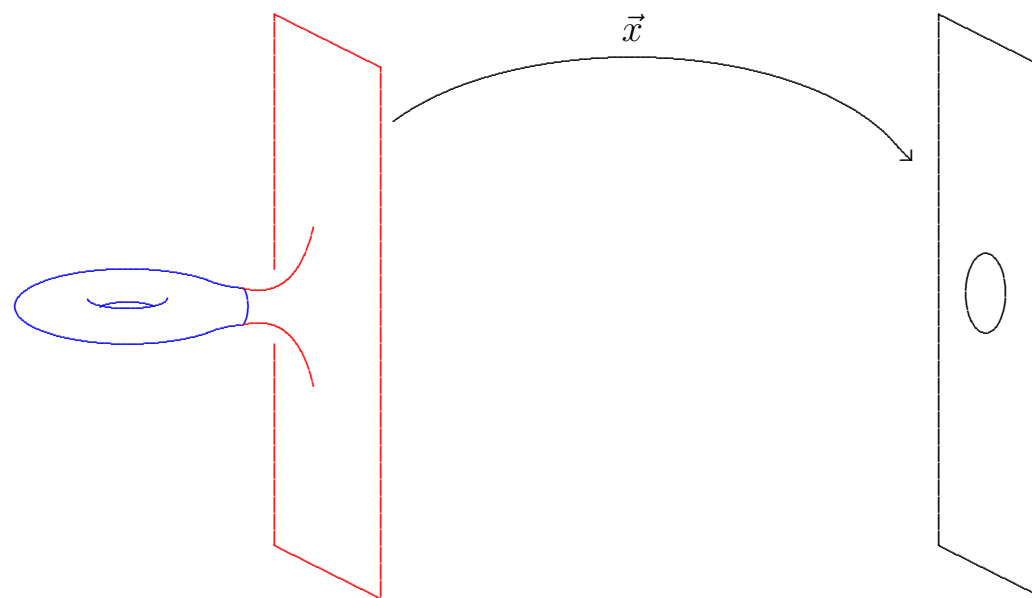

Weakest reasonable assumption:

Definition. A complete, non-compact Riemannian n -manifold (M^n, g) is called **asymptotically Euclidean (AE)** if there is a compact set $K \subset M$ such that $M - K$ is diffeomorphic to $\mathbb{R}^n - D^n$ in such a manner that

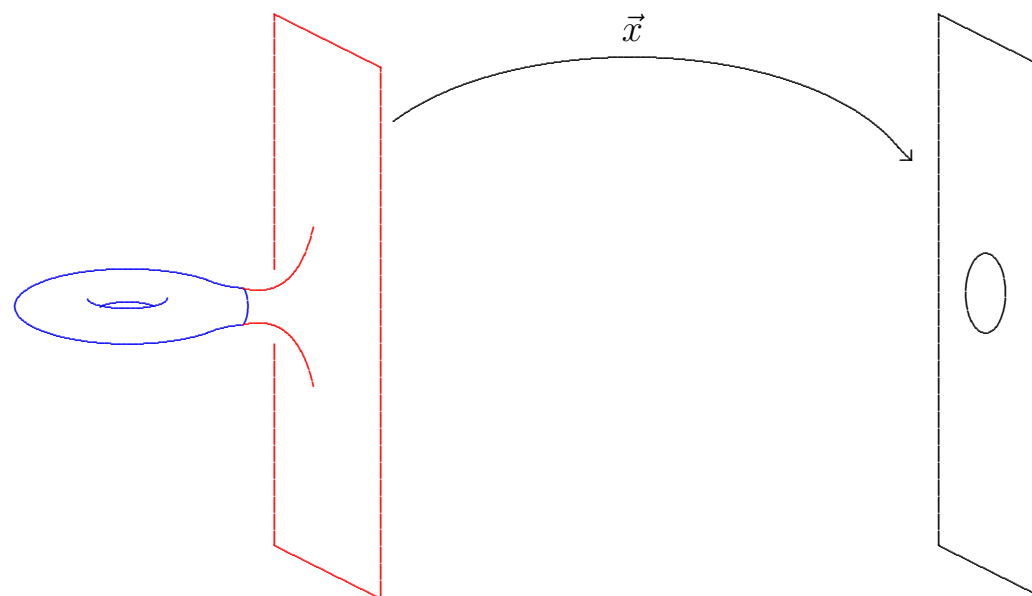

Weakest reasonable assumption:

Chruściel-type fall-off:

Definition. A complete, non-compact Riemannian n -manifold (M^n, g) is called **asymptotically Euclidean (AE)** if there is a compact set $K \subset M$ such that $M - K$ is diffeomorphic to $\mathbb{R}^n - D^n$ in such a manner that

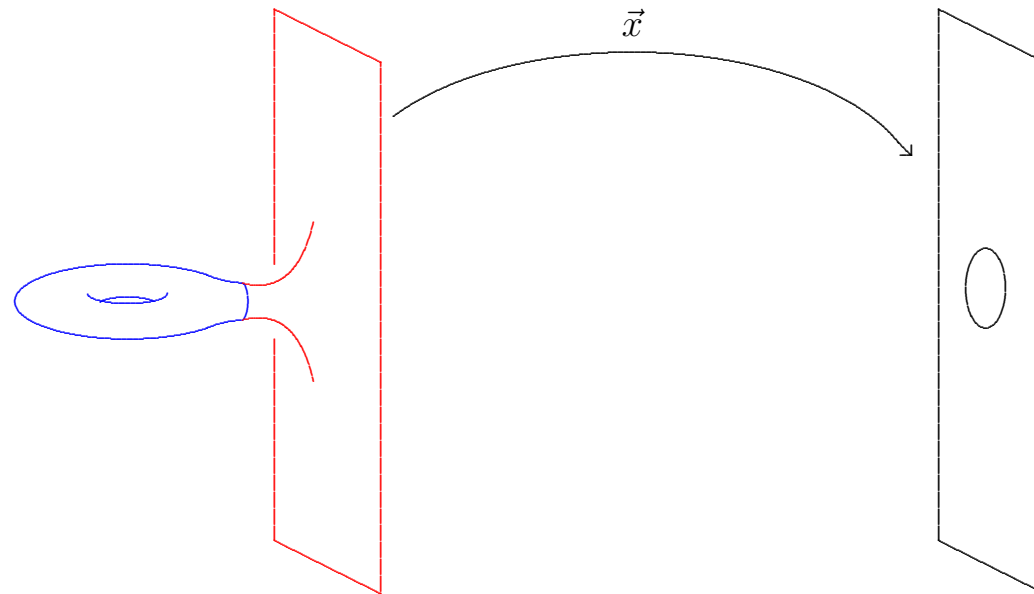

$$g_{jk} = \delta_{jk} + O(|x|^{1-\frac{n}{2}-\varepsilon})$$

Definition. A complete, non-compact Riemannian n -manifold (M^n, g) is called **asymptotically Euclidean (AE)** if there is a compact set $K \subset M$ such that $M - K$ is diffeomorphic to $\mathbb{R}^n - D^n$ in such a manner that

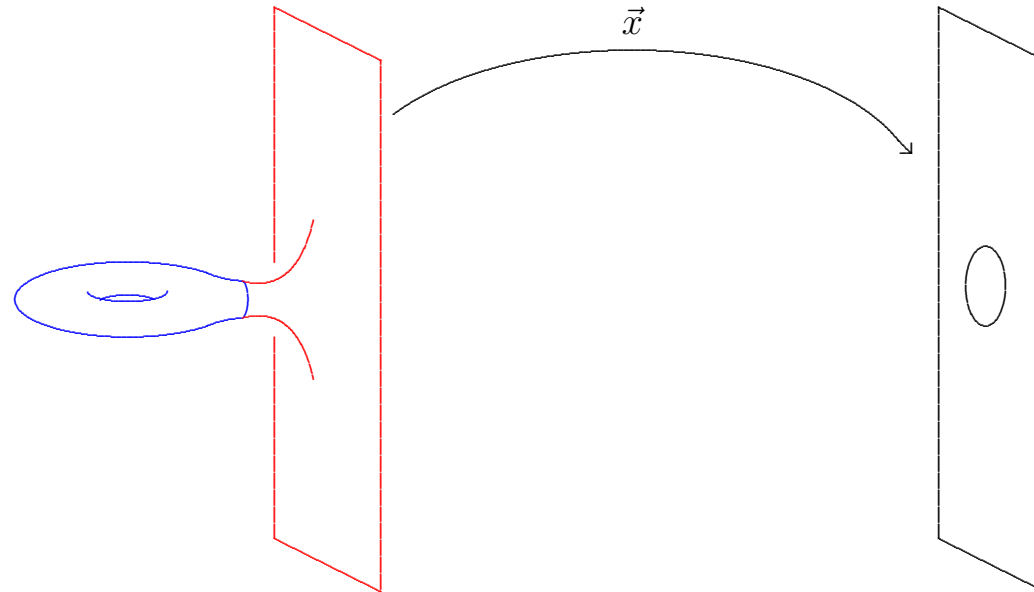

$$g_{jk} = \delta_{jk} + O(|x|^{1-\frac{n}{2}-\varepsilon})$$

$$g_{jk,\ell} = O(|x|^{-\frac{n}{2}-\varepsilon})$$

Definition. A complete, non-compact Riemannian n -manifold (M^n, g) is called **asymptotically Euclidean (AE)** if there is a compact set $K \subset M$ such that $M - K$ is diffeomorphic to $\mathbb{R}^n - D^n$ in such a manner that

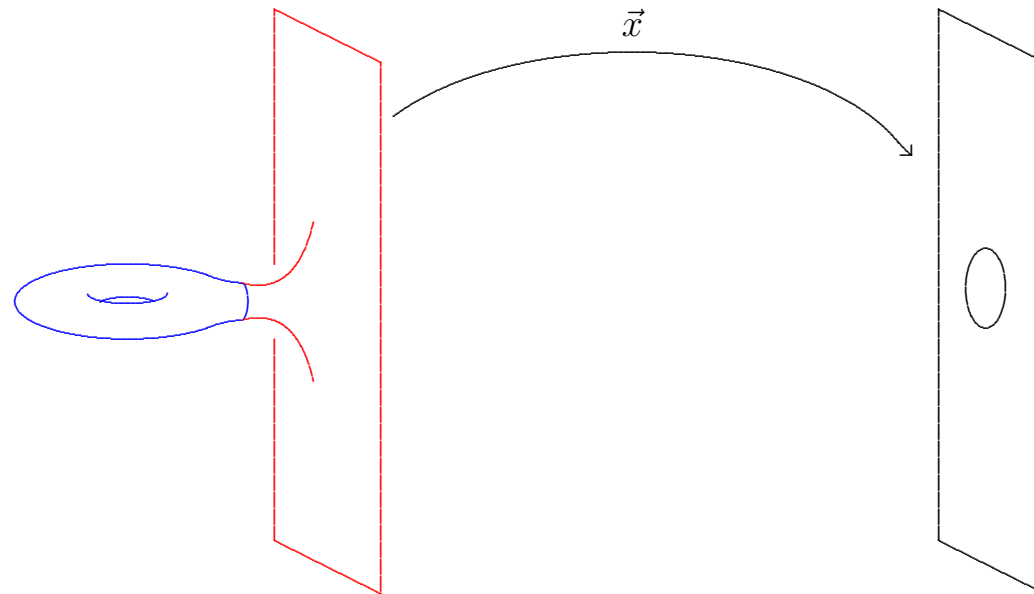

$$g_{jk} = \delta_{jk} + O(|x|^{1-\frac{n}{2}-\varepsilon})$$

$$g_{jk,\ell} = O(|x|^{-\frac{n}{2}-\varepsilon}), \quad s \in L^1$$

Definition. A complete, non-compact Riemannian n -manifold (M^n, g) is called **asymptotically Euclidean (AE)** if there is a compact set $K \subset M$ such that $M - K$ is diffeomorphic to $\mathbb{R}^n - D^n$ in such a manner that

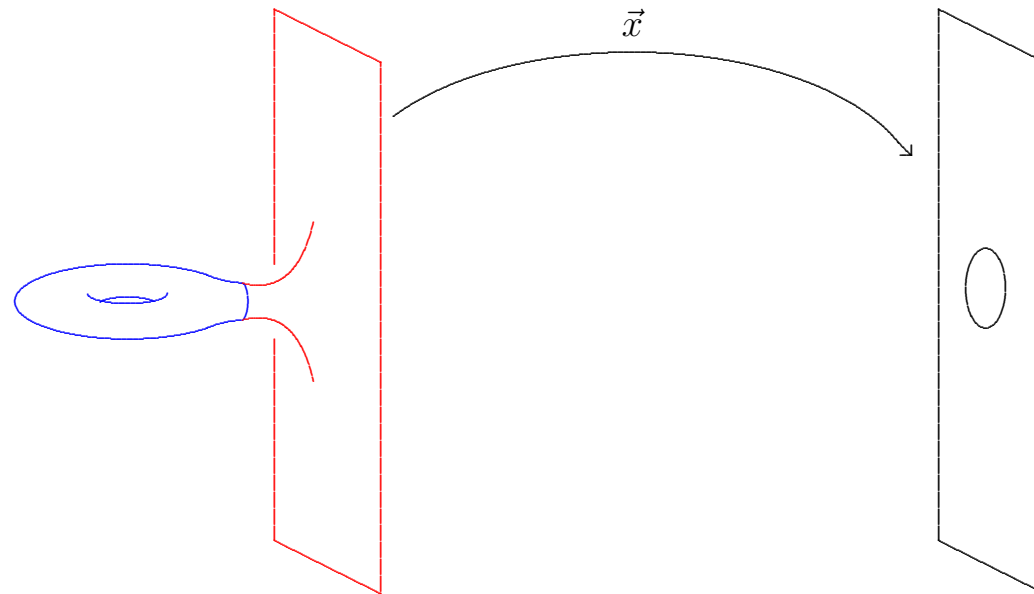

$$g_{jk} = \delta_{jk} + O(|x|^{1-\frac{n}{2}-\varepsilon})$$

$$g_{jk,\ell} = O(|x|^{-\frac{n}{2}-\varepsilon}), \quad \text{scalar curvature} \in L^1$$

Definition. A complete, non-compact Riemannian n -manifold (M^n, g) is called **asymptotically Euclidean (AE)** if there is a compact set $K \subset M$ such that $M - K$ is diffeomorphic to $\mathbb{R}^n - D^n$ in such a manner that

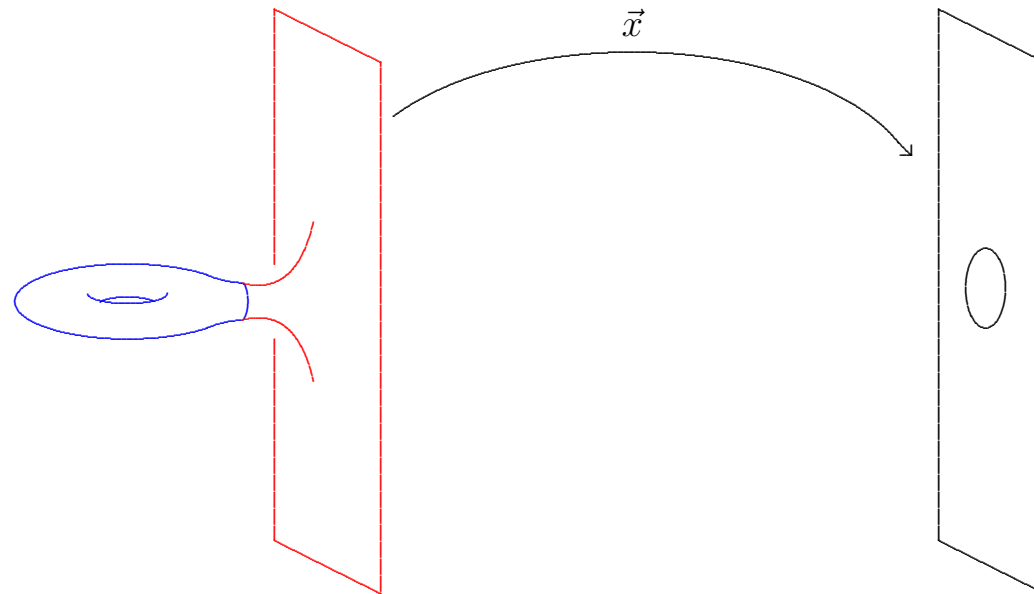

$$g_{jk} = \delta_{jk} + O(|x|^{1-\frac{n}{2}-\varepsilon})$$

$$g_{jk,\ell} = O(|x|^{-\frac{n}{2}-\varepsilon}), \quad s \in L^1$$

Definition. A complete, non-compact Riemannian n -manifold (M^n, g) is called **asymptotically Euclidean (AE)** if there is a compact set $K \subset M$ such that each component of $M - K$ is diffeomorphic to $\mathbb{R}^n - D^n$ in such a manner that

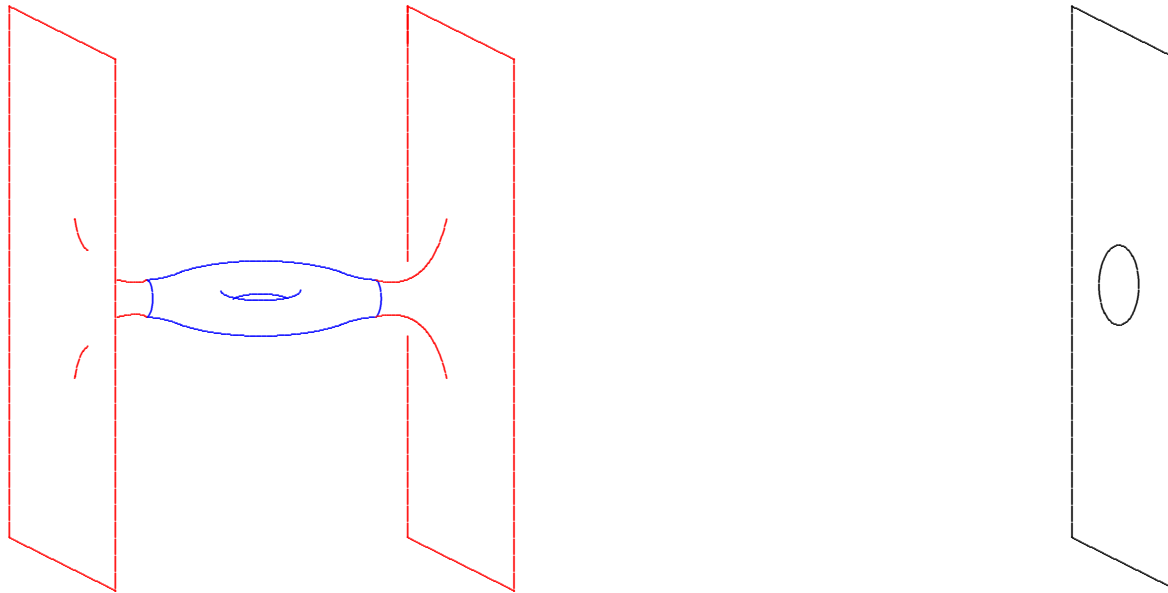

$$g_{jk} = \delta_{jk} + O(|x|^{1-\frac{n}{2}-\varepsilon})$$

$$g_{jk,\ell} = O(|x|^{-\frac{n}{2}-\varepsilon}), \quad s \in L^1$$

Definition. A complete, non-compact Riemannian n -manifold (M^n, g) is called **asymptotically Euclidean (AE)** if there is a compact set $K \subset M$ such that each component of $M - K$ is diffeomorphic to $\mathbb{R}^n - D^n$ in such a manner that

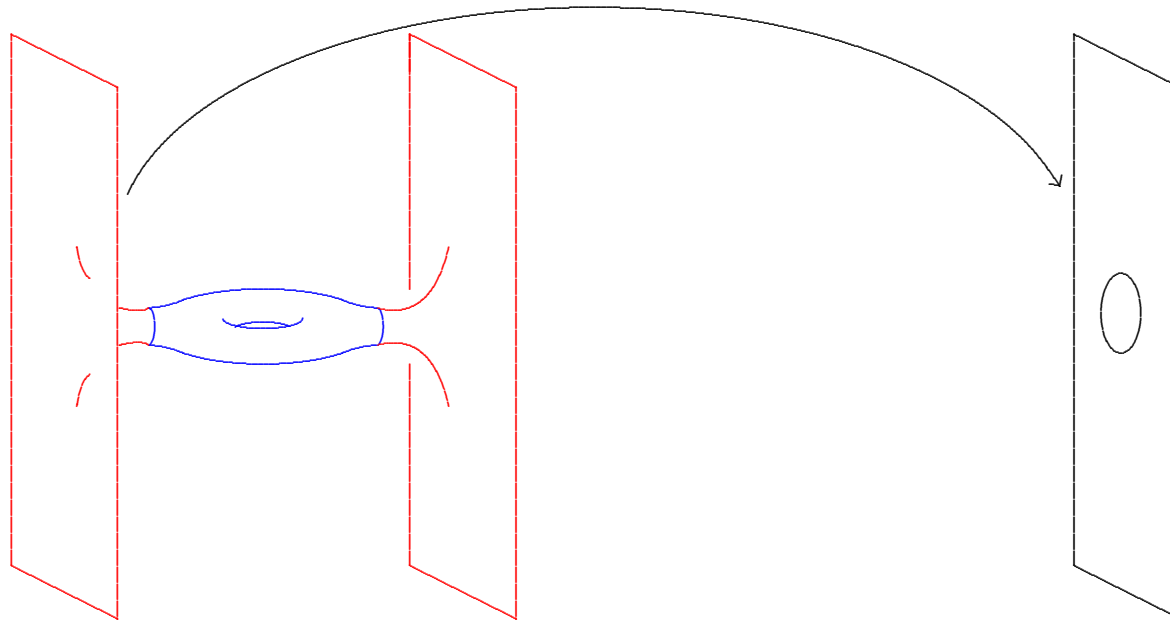

$$g_{jk} = \delta_{jk} + O(|x|^{1-\frac{n}{2}-\varepsilon})$$

$$g_{jk,\ell} = O(|x|^{-\frac{n}{2}-\varepsilon}), \quad s \in L^1$$

Definition. A complete, non-compact Riemannian n -manifold (M^n, g) is called **asymptotically Euclidean (AE)** if there is a compact set $K \subset M$ such that each component of $M - K$ is diffeomorphic to $\mathbb{R}^n - D^n$ in such a manner that

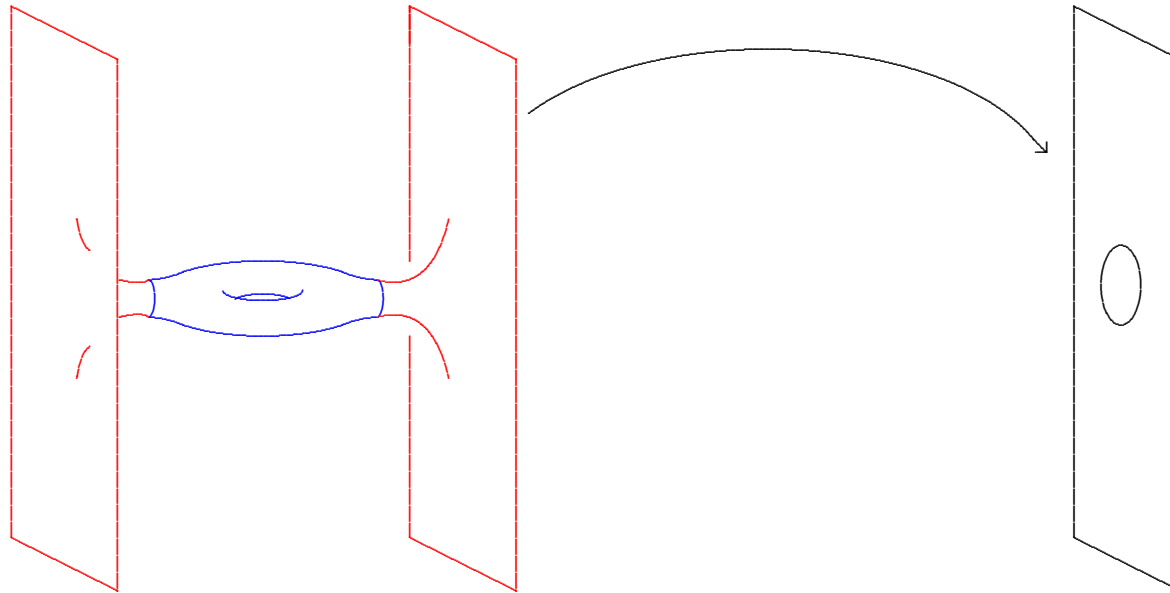

$$g_{jk} = \delta_{jk} + O(|x|^{1-\frac{n}{2}-\varepsilon})$$

$$g_{jk,\ell} = O(|x|^{-\frac{n}{2}-\varepsilon}), \quad s \in L^1$$

Definition. A complete, non-compact Riemannian n -manifold (M^n, g) is called **asymptotically Euclidean (AE)** if there is a compact set $K \subset M$ such that each component of $M - K$ is diffeomorphic to $\mathbb{R}^n - D^n$ in such a manner that

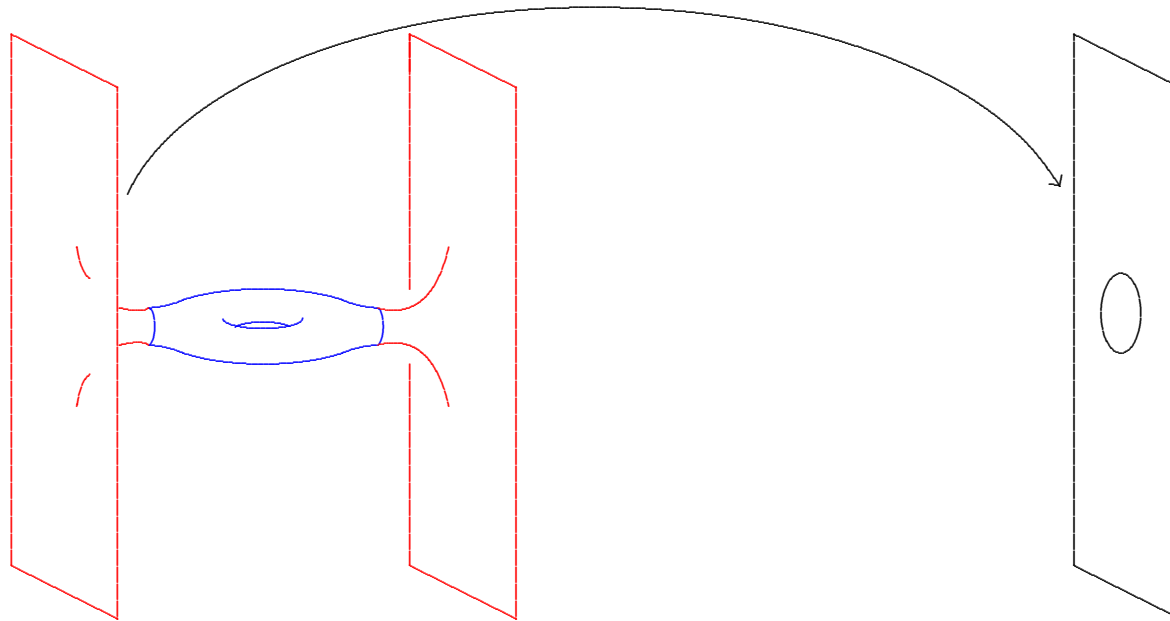

$$g_{jk} = \delta_{jk} + O(|x|^{1-\frac{n}{2}-\varepsilon})$$

$$g_{jk,\ell} = O(|x|^{-\frac{n}{2}-\varepsilon}), \quad s \in L^1$$

Definition. A complete, non-compact Riemannian n -manifold (M^n, g) is called **asymptotically Euclidean (AE)** if there is a compact set $K \subset M$ such that each component of $M - K$ is diffeomorphic to $\mathbb{R}^n - D^n$ in such a manner that

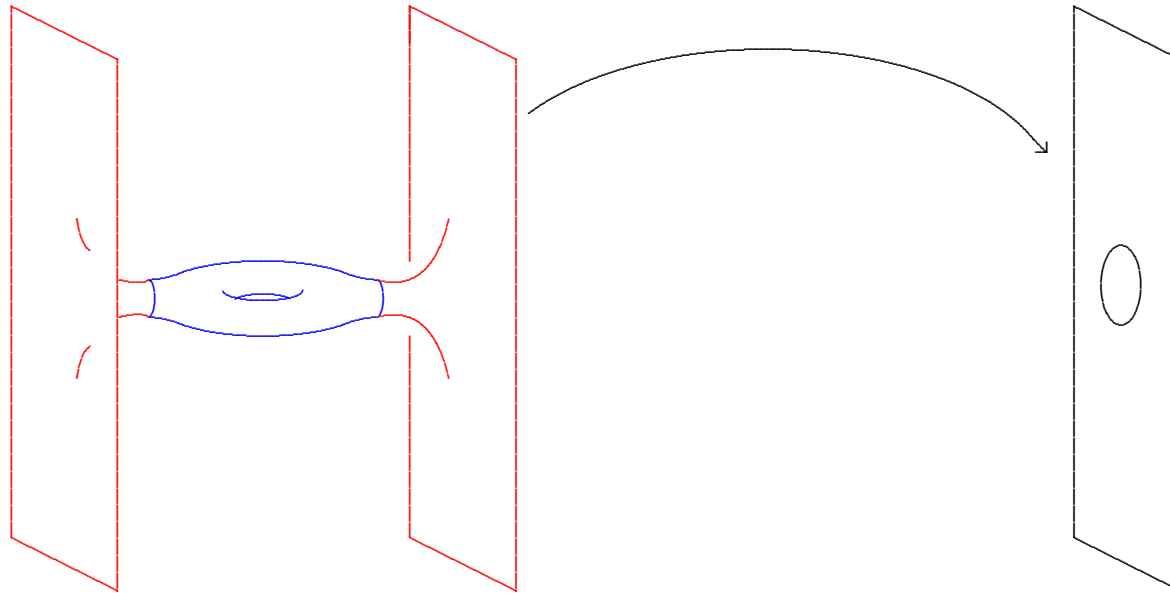

$$g_{jk} = \delta_{jk} + O(|x|^{1-\frac{n}{2}-\varepsilon})$$

$$g_{jk,\ell} = O(|x|^{-\frac{n}{2}-\varepsilon}), \quad s \in L^1$$

Definition. A complete, non-compact Riemannian n -manifold (M^n, g) is called **asymptotically Euclidean (AE)** if there is a compact set $K \subset M$ such that each “end” is diffeomorphic to $\mathbb{R}^n - D^n$ in such a manner that

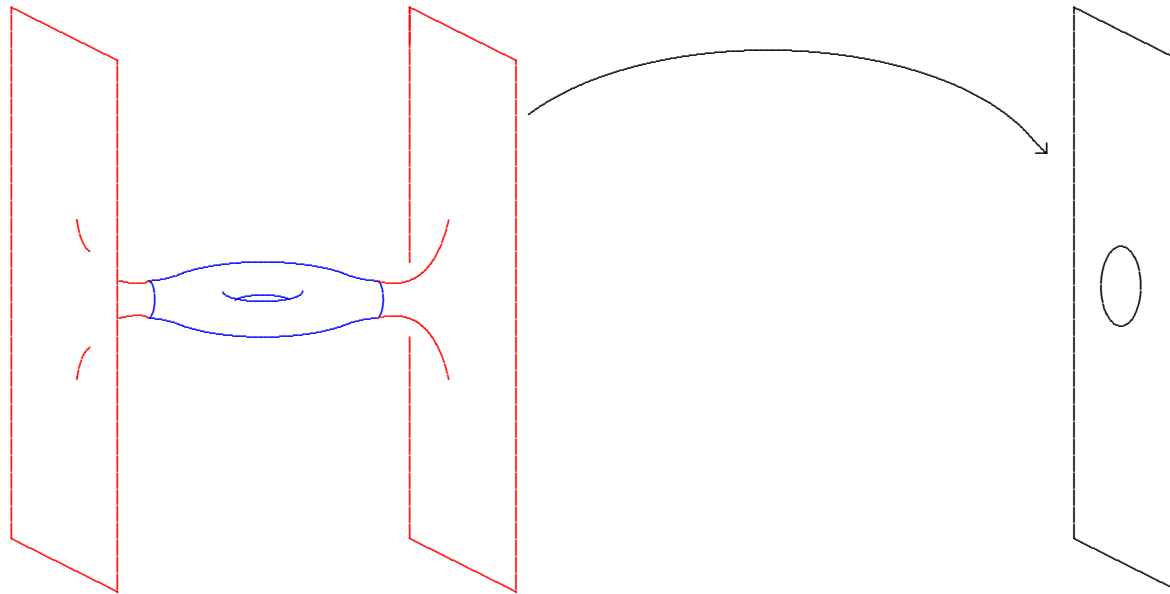

$$g_{jk} = \delta_{jk} + O(|x|^{1-\frac{n}{2}-\varepsilon})$$

$$g_{jk,\ell} = O(|x|^{-\frac{n}{2}-\varepsilon}), \quad s \in L^1$$

Definition. *The mass (at a given end) of an AE n -manifold is defined to be*

$$m(M, g) := [g_{ij,i} - g_{ii,j}]$$

Definition. *The mass (at a given end) of an AE n -manifold is defined to be*

$$m(M, g) := \int [g_{ij,i} - g_{ii,j}] \nu^j$$

Definition. *The mass (at a given end) of an AE n -manifold is defined to be*

$$m(M, g) := \int_{\Sigma(\varrho)} [g_{ij,i} - g_{ii,j}] \nu^j \alpha_E$$

Definition. *The mass (at a given end) of an AE n -manifold is defined to be*

$$m(M, g) := \lim_{\varrho \rightarrow \infty} \int_{\Sigma(\varrho)} [g_{ij,i} - g_{ii,j}] \nu^j \alpha_E$$

Definition. *The mass (at a given end) of an AE n -manifold is defined to be*

$$m(M, g) := \lim_{\varrho \rightarrow \infty} \frac{\Gamma(\frac{n}{2})}{4(n-1)\pi^{n/2}} \int_{\Sigma(\varrho)} [g_{ij,i} - g_{ii,j}] \nu^j \alpha_E$$

Definition. *The mass (at a given end) of an AE n -manifold is defined to be*

$$m(M, g) := \lim_{\varrho \rightarrow \infty} \frac{\Gamma(\frac{n}{2})}{4(n-1)\pi^{n/2}} \int_{\Sigma(\varrho)} [g_{ij,i} - g_{ii,j}] \nu^j \alpha_E$$

where

Definition. *The mass (at a given end) of an AE n -manifold is defined to be*

$$m(M, g) := \lim_{\varrho \rightarrow \infty} \frac{\Gamma(\frac{n}{2})}{4(n-1)\pi^{n/2}} \int_{\Sigma(\varrho)} [g_{ij,i} - g_{ii,j}] \nu^j \alpha_E$$

where

- $\Sigma(\varrho) \approx S^{n-1}$

Definition. *The mass (at a given end) of an AE n -manifold is defined to be*

$$m(M, g) := \lim_{\varrho \rightarrow \infty} \frac{\Gamma(\frac{n}{2})}{4(n-1)\pi^{n/2}} \int_{\Sigma(\varrho)} [g_{ij,i} - g_{ii,j}] \nu^j \alpha_E$$

where

- $\Sigma(\varrho) \approx S^{n-1}$ is given by $|\vec{x}| = \varrho$;

Definition. *The mass (at a given end) of an AE n -manifold is defined to be*

$$m(M, g) := \lim_{\varrho \rightarrow \infty} \frac{\Gamma(\frac{n}{2})}{4(n-1)\pi^{n/2}} \int_{\Sigma(\varrho)} [g_{ij,i} - g_{ii,j}] \nu^j \alpha_E$$

where

- $\Sigma(\varrho) \approx S^{n-1}$ is given by $|\vec{x}| = \varrho$;
- ν is the outpointing Euclidean unit normal;

Definition. *The mass (at a given end) of an AE n -manifold is defined to be*

$$m(M, g) := \lim_{\varrho \rightarrow \infty} \frac{\Gamma(\frac{n}{2})}{4(n-1)\pi^{n/2}} \int_{\Sigma(\varrho)} [g_{ij,i} - g_{ii,j}] \nu^j \alpha_E$$

where

- $\Sigma(\varrho) \approx S^{n-1}$ is given by $|\vec{x}| = \varrho$;
- ν is the outpointing Euclidean unit normal;
and
- α_E is the volume $(n-1)$ -form induced by the Euclidean metric.

Definition. *The mass (at a given end) of an AE n -manifold is defined to be*

$$m(M, g) := \lim_{\varrho \rightarrow \infty} \frac{\Gamma(\frac{n}{2})}{4(n-1)\pi^{n/2}} \int_{\Sigma(\varrho)} [g_{ij,i} - g_{ii,j}] \nu^j \alpha_E$$

where

- $\Sigma(\varrho) \approx S^{n-1}$ is given by $|\vec{x}| = \varrho$;
- ν is the outpointing Euclidean unit normal;
and
- α_E is the volume $(n-1)$ -form induced by the Euclidean metric.

Seems to depend on choice of coordinates!

Definition. *The mass (at a given end) of an AE n -manifold is defined to be*

$$m(M, g) := \lim_{\varrho \rightarrow \infty} \frac{\Gamma(\frac{n}{2})}{4(n-1)\pi^{n/2}} \int_{\Sigma(\varrho)} [g_{ij,i} - g_{ii,j}] \nu^j \alpha_E$$

where

- $\Sigma(\varrho) \approx S^{n-1}$ is given by $|\vec{x}| = \varrho$;
- ν is the outpointing Euclidean unit normal;
and
- α_E is the volume $(n-1)$ -form induced by the Euclidean metric.

Definition. *The mass (at a given end) of an AE n -manifold is defined to be*

$$m(M, g) := \lim_{\varrho \rightarrow \infty} \frac{\Gamma(\frac{n}{2})}{4(n-1)\pi^{n/2}} \int_{\Sigma(\varrho)} [g_{ij,i} - g_{ii,j}] \nu^j \alpha_E$$

where

- $\Sigma(\varrho) \approx S^{n-1}$ is given by $|\vec{x}| = \varrho$;
- ν is the outpointing Euclidean unit normal;
and
- α_E is the volume $(n-1)$ -form induced by the Euclidean metric.

Bartnik/Chruściel (1986):

Definition. *The mass (at a given end) of an AE n -manifold is defined to be*

$$m(M, g) := \lim_{\varrho \rightarrow \infty} \frac{\Gamma(\frac{n}{2})}{4(n-1)\pi^{n/2}} \int_{\Sigma(\varrho)} [g_{ij,i} - g_{ii,j}] \nu^j \alpha_E$$

where

- $\Sigma(\varrho) \approx S^{n-1}$ is given by $|\vec{x}| = \varrho$;
- ν is the outpointing Euclidean unit normal;
and
- α_E is the volume $(n-1)$ -form induced by the Euclidean metric.

Bartnik/Chruściel (1986): With weak fall-off conditions,

Definition. *The mass (at a given end) of an AE n -manifold is defined to be*

$$m(M, g) := \lim_{\varrho \rightarrow \infty} \frac{\Gamma(\frac{n}{2})}{4(n-1)\pi^{n/2}} \int_{\Sigma(\varrho)} [g_{ij,i} - g_{ii,j}] \nu^j \alpha_E$$

where

- $\Sigma(\varrho) \approx S^{n-1}$ is given by $|\vec{x}| = \varrho$;
- ν is the outpointing Euclidean unit normal;
and
- α_E is the volume $(n-1)$ -form induced by the Euclidean metric.

Bartnik/Chruściel (1986): With weak fall-off conditions, the mass is well-defined

Definition. *The mass (at a given end) of an AE n -manifold is defined to be*

$$m(M, g) := \lim_{\varrho \rightarrow \infty} \frac{\Gamma(\frac{n}{2})}{4(n-1)\pi^{n/2}} \int_{\Sigma(\varrho)} [g_{ij,i} - g_{ii,j}] \nu^j \alpha_E$$

where

- $\Sigma(\varrho) \approx S^{n-1}$ is given by $|\vec{x}| = \varrho$;
- ν is the outpointing Euclidean unit normal;
and
- α_E is the volume $(n-1)$ -form induced by the Euclidean metric.

Bartnik/Chruściel (1986): With weak fall-off conditions, the mass is well-defined & coordinate independent.

Definition. *The mass (at a given end) of an AE n -manifold is defined to be*

$$m(M, g) := \lim_{\varrho \rightarrow \infty} \frac{\Gamma(\frac{n}{2})}{4(n-1)\pi^{n/2}} \int_{\Sigma(\varrho)} [g_{ij,i} - g_{ii,j}] \nu^j \alpha_E$$

where

- $\Sigma(\varrho) \approx S^{n-1}$ is given by $|\vec{x}| = \varrho$;
- ν is the outpointing Euclidean unit normal;
and
- α_E is the volume $(n-1)$ -form induced by the Euclidean metric.

Chruściel (1986):

Definition. *The mass (at a given end) of an AE n -manifold is defined to be*

$$m(M, g) := \lim_{\varrho \rightarrow \infty} \frac{\Gamma(\frac{n}{2})}{4(n-1)\pi^{n/2}} \int_{\Sigma(\varrho)} [g_{ij,i} - g_{ii,j}] \nu^j \alpha_E$$

where

- $\Sigma(\varrho) \approx S^{n-1}$ is given by $|\vec{x}| = \varrho$;
- ν is the outpointing Euclidean unit normal;
and
- α_E is the volume $(n-1)$ -form induced by the Euclidean metric.

$$g_{jk} = \delta_{jk} + O(|x|^{1-\frac{n}{2}-\varepsilon})$$

$$g_{jk,\ell} = O(|x|^{-\frac{n}{2}-\varepsilon}), \quad s \in L^1$$

Motivation:

Motivation:

When $n = 3$, ADM mass in general relativity.

Motivation:

When $n = 3$, ADM mass in general relativity.

Reads off “apparent mass” from strength of the gravitational field far from an isolated source.

Motivation:

When $n = 3$, ADM mass in general relativity.

Reads off “apparent mass” from strength of the gravitational field far from an isolated source.

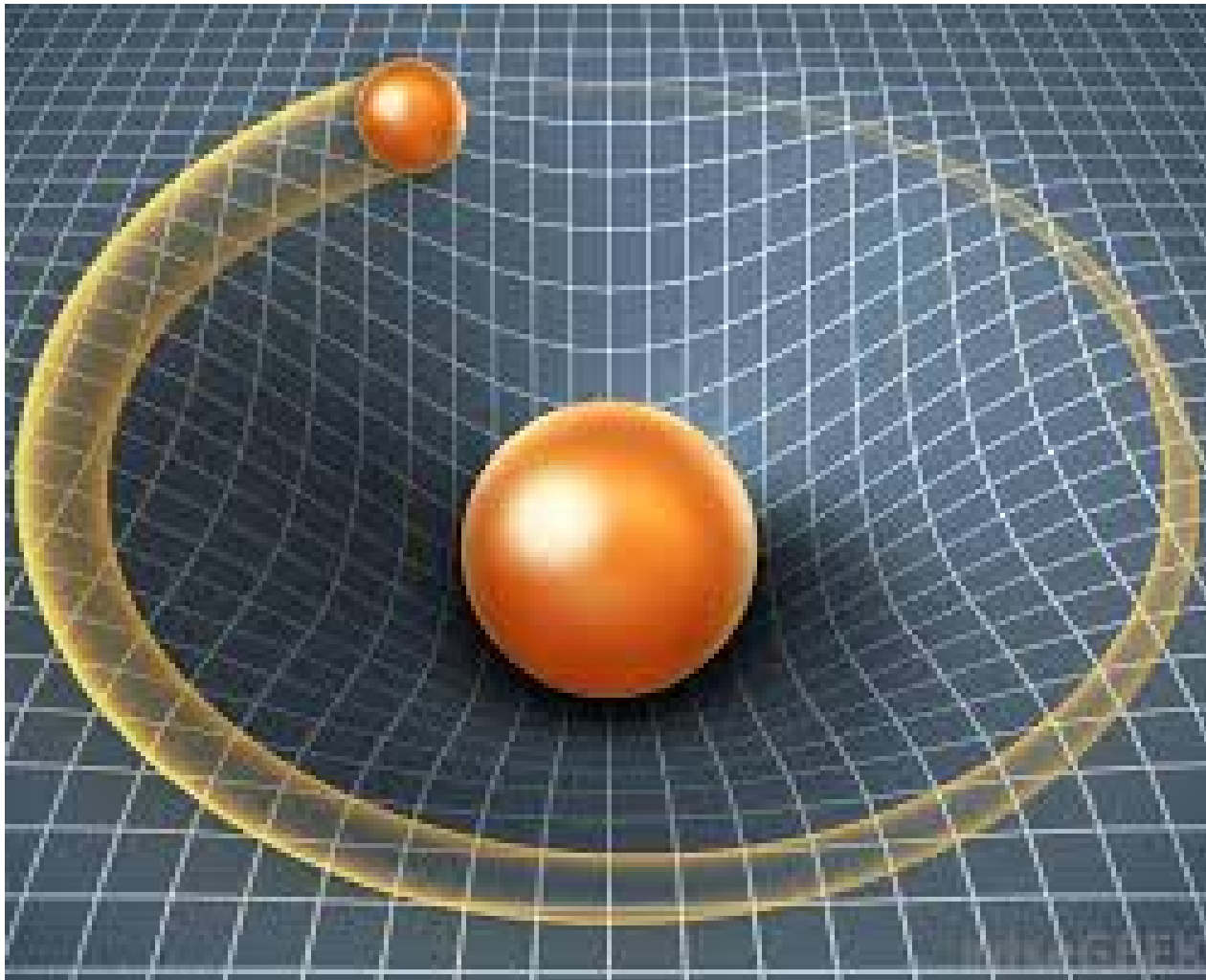

Motivation:

When $n = 3$, ADM mass in general relativity.

Reads off “apparent mass” from strength of the gravitational field far from an isolated source.

Motivation:

When $n = 3$, ADM mass in general relativity.

Reads off “apparent mass” from strength of the gravitational field far from an isolated source.

In any dimension, reproduces “mass” of $t = 0$ hypersurface in $(n + 1)$ -dimensional Schwarzschild

Motivation:

When $n = 3$, ADM mass in general relativity.

Reads off “apparent mass” from strength of the gravitational field far from an isolated source.

In any dimension, reproduces “mass” of $t = 0$ hypersurface in $(n + 1)$ -dimensional Schwarzschild

$$g = - \left(1 - \frac{2m}{\rho^{n-2}} \right) dt^2 + \left(1 - \frac{2m}{\rho^{n-2}} \right)^{-1} d\rho^2 + \rho^2 h_{S^{n-1}}$$

Motivation:

When $n = 3$, ADM mass in general relativity.

Reads off “apparent mass” from strength of the gravitational field far from an isolated source.

In any dimension, reproduces “mass” of $t = 0$ hypersurface in $(n + 1)$ -dimensional Schwarzschild

$$g = \left(1 - \frac{2m}{\varrho^{n-2}}\right)^{-1} d\varrho^2 + \varrho^2 h_{S^{n-1}}$$

Motivation:

When $n = 3$, ADM mass in general relativity.

Reads off “apparent mass” from strength of the gravitational field far from an isolated source.

In any dimension, reproduces “mass” of $t = 0$ hypersurface in $(n + 1)$ -dimensional Schwarzschild

$$g = \left(1 - \frac{2m}{\varrho^{n-2}}\right)^{-1} d\varrho^2 + \varrho^2 h_{S^{n-1}}$$

Two such regions fit together to form the wormhole metric.

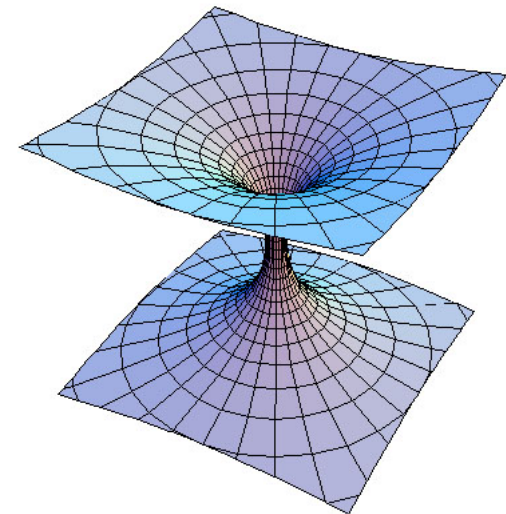

Motivation:

When $n = 3$, ADM mass in general relativity.

Reads off “apparent mass” from strength of the gravitational field far from an isolated source.

In any dimension, reproduces “mass” of $t = 0$ hypersurface in $(n + 1)$ -dimensional Schwarzschild

$$g = \left(1 - \frac{2m}{\varrho^{n-2}}\right)^{-1} d\varrho^2 + \varrho^2 h_{S^{n-1}}$$

Two such regions fit together to form the wormhole metric. Scalar-flat, AE, two ends.

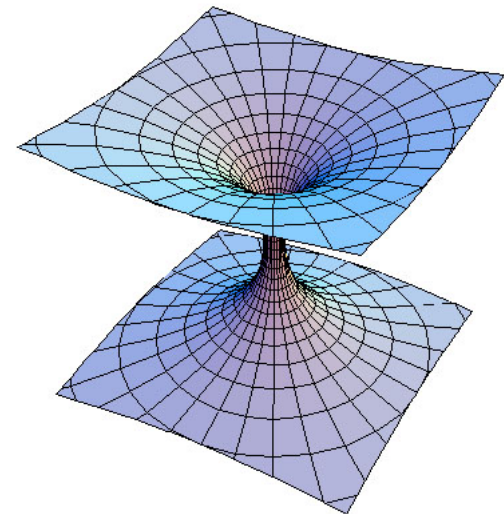

Motivation:

When $n = 3$, ADM mass in general relativity.

Reads off “apparent mass” from strength of the gravitational field far from an isolated source.

In any dimension, reproduces “mass” of $t = 0$ hypersurface in $(n + 1)$ -dimensional Schwarzschild

$$g = \left(1 - \frac{2m}{\varrho^{n-2}}\right)^{-1} d\varrho^2 + \varrho^2 h_{S^{n-1}}$$

Two such regions fit together to form the wormhole metric. Scalar-flat, AE, two ends. Not Ricci-flat, but conformally flat.

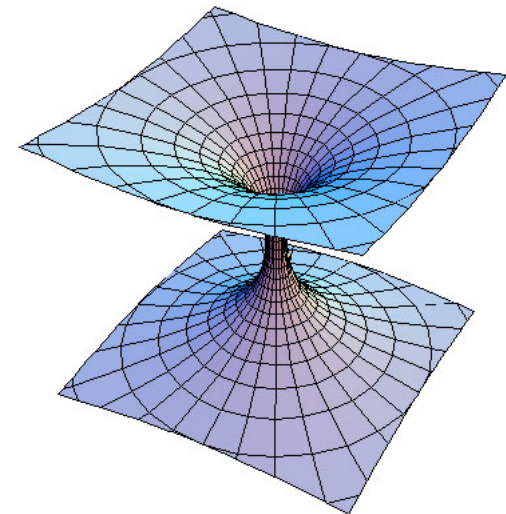

Motivation:

When $n = 3$, ADM mass in general relativity.

Reads off “apparent mass” from strength of the gravitational field far from an isolated source.

In any dimension, reproduces “mass” of $t = 0$ hypersurface in $(n + 1)$ -dimensional Schwarzschild

$$g = \left(1 - \frac{2m}{\varrho^{n-2}}\right)^{-1} d\varrho^2 + \varrho^2 h_{S^{n-1}}$$

Two such regions fit together to form the wormhole metric. Scalar-flat, AE, two ends. Not Ricci-flat, but conformally flat. Same mass m at both ends:

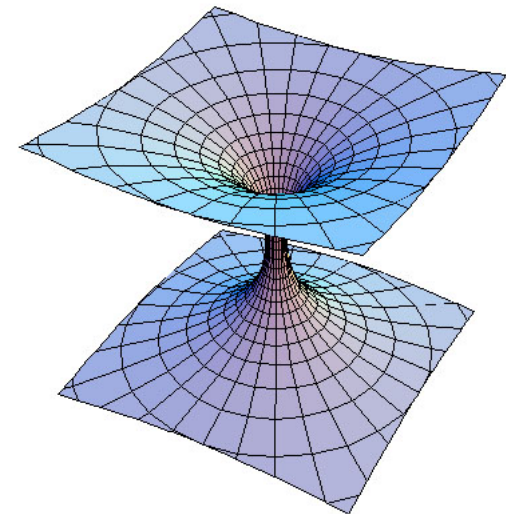

Motivation:

When $n = 3$, ADM mass in general relativity.

Reads off “apparent mass” from strength of the gravitational field far from an isolated source.

In any dimension, reproduces “mass” of $t = 0$ hypersurface in $(n + 1)$ -dimensional Schwarzschild

$$g = \left(1 - \frac{2m}{\varrho^{n-2}}\right)^{-1} d\varrho^2 + \varrho^2 h_{S^{n-1}}$$

Two such regions fit together to form the wormhole metric. Scalar-flat, AE, two ends. Not Ricci-flat, but conformally flat. Same mass m at both ends: “size of throat.”

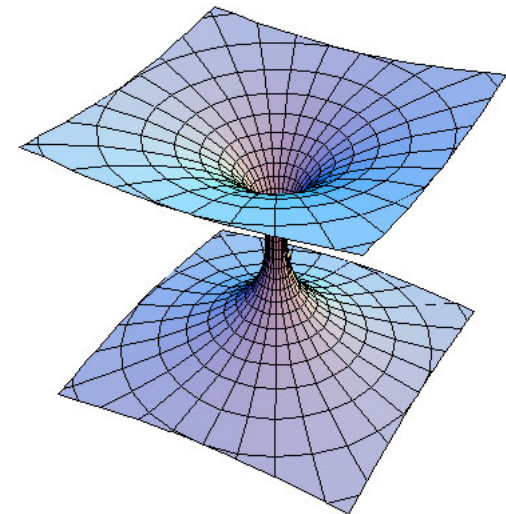

Motivation:

When $n = 3$, ADM mass in general relativity.

Reads off “apparent mass” from strength of the gravitational field far from an isolated source.

In any dimension, reproduces “mass” of $t = 0$ hypersurface in $(n + 1)$ -dimensional Schwarzschild

$$g = \left(1 + \frac{m/2}{r^{n-2}} \right)^{4/(n-2)} \left[\sum (dx^j)^2 \right]$$

Two such regions fit together to form the wormhole metric. Scalar-flat, AE, two ends. Not Ricci-flat, but conformally flat. Same mass m at both ends: “size of throat.”

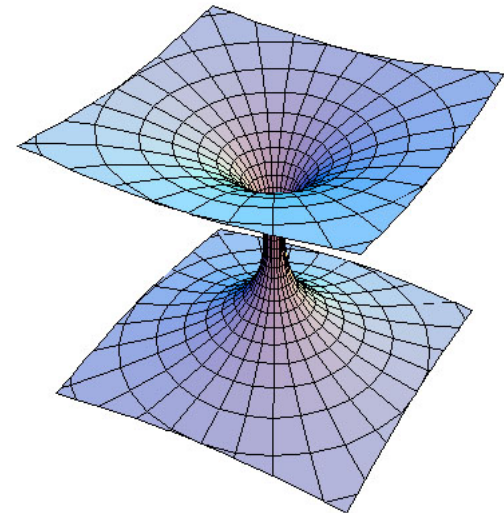

Motivation:

When $n = 3$, ADM mass in general relativity.

Reads off “apparent mass” from strength of the gravitational field far from an isolated source.

In any dimension, reproduces “mass” of $t = 0$ hypersurface in $(n + 1)$ -dimensional Schwarzschild

$$g_{jk} = \left(1 + \frac{2m}{(n-2)r^{n-2}} \right) \delta_{jk} + \dots$$

Motivation:

When $n = 3$, ADM mass in general relativity.

Reads off “apparent mass” from strength of the gravitational field far from an isolated source.

In any dimension, reproduces “mass” of $t = 0$ hypersurface in $(n + 1)$ -dimensional Schwarzschild

$$g = \left(1 - \frac{2m}{\varrho^{n-2}}\right)^{-1} d\varrho^2 + \varrho^2 h_{S^{n-1}}$$

Motivation:

When $n = 3$, ADM mass in general relativity.

Reads off “apparent mass” from strength of the gravitational field far from an isolated source.

In any dimension, reproduces “mass” of $t = 0$ hypersurface in $(n + 1)$ -dimensional Schwarzschild

$$g = \left(1 - \frac{2m}{\varrho^{n-2}}\right)^{-1} d\varrho^2 + \varrho^2 h_{S^{n-1}}$$

Burns metric on $\widetilde{\mathbb{C}^2}$

Motivation:

When $n = 3$, ADM mass in general relativity.

Reads off “apparent mass” from strength of the gravitational field far from an isolated source.

In any dimension, reproduces “mass” of $t = 0$ hypersurface in $(n + 1)$ -dimensional Schwarzschild

$$g = \left(1 - \frac{2m}{\varrho^{n-2}}\right)^{-1} d\varrho^2 + \varrho^2 h_{S^{n-1}}$$

Burns metric on $\widetilde{\mathbb{C}^2} \subset \mathbb{C}^2 \times \mathbb{C}P_1$

Motivation:

When $n = 3$, ADM mass in general relativity.

Reads off “apparent mass” from strength of the gravitational field far from an isolated source.

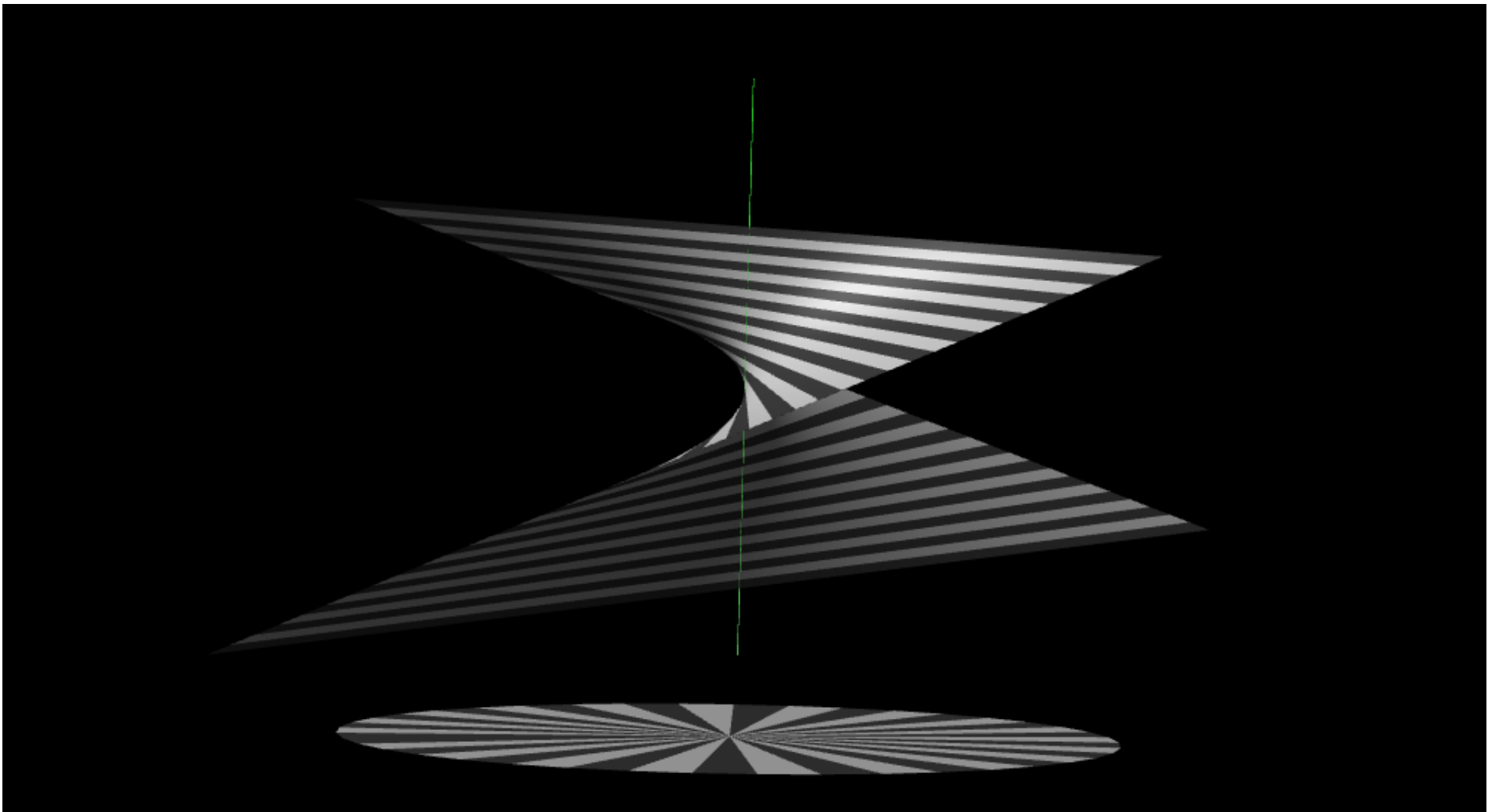

Motivation:

When $n = 3$, ADM mass in general relativity.

Reads off “apparent mass” from strength of the gravitational field far from an isolated source.

In any dimension, reproduces “mass” of $t = 0$ hypersurface in $(n + 1)$ -dimensional Schwarzschild

$$g = \left(1 - \frac{2m}{\varrho^{n-2}}\right)^{-1} d\varrho^2 + \varrho^2 h_{S^{n-1}}$$

Burns metric on $\widetilde{\mathbb{C}^2} \subset \mathbb{C}^2 \times \mathbb{C}P_1$

Motivation:

When $n = 3$, ADM mass in general relativity.

Reads off “apparent mass” from strength of the gravitational field far from an isolated source.

In any dimension, reproduces “mass” of $t = 0$ hypersurface in $(n + 1)$ -dimensional Schwarzschild

$$g = \left(1 - \frac{2m}{\varrho^{n-2}}\right)^{-1} d\varrho^2 + \varrho^2 h_{S^{n-1}}$$

Scalar-flat-Kähler Burns metric on $\widetilde{\mathbb{C}^2} \subset \mathbb{C}^2 \times \mathbb{CP}_1$

(M^n, g) :

holonomy

(M^n, g) :

holonomy

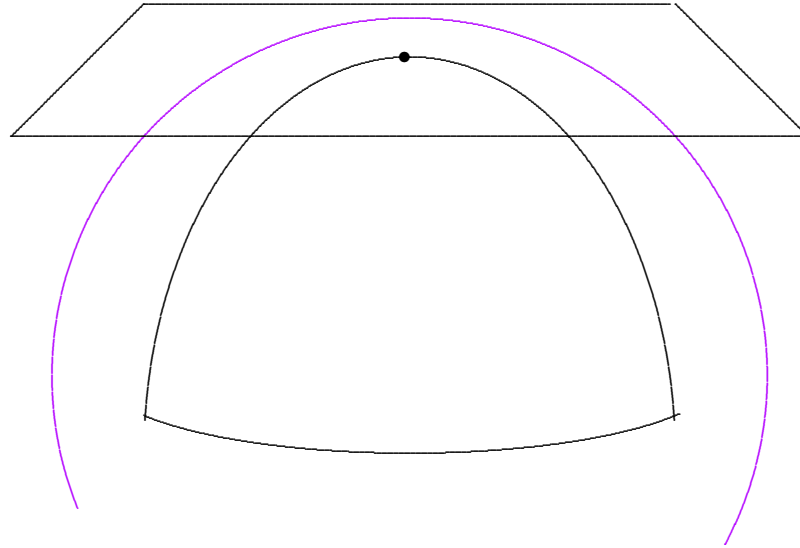

$(M^n, g):$

holonomy

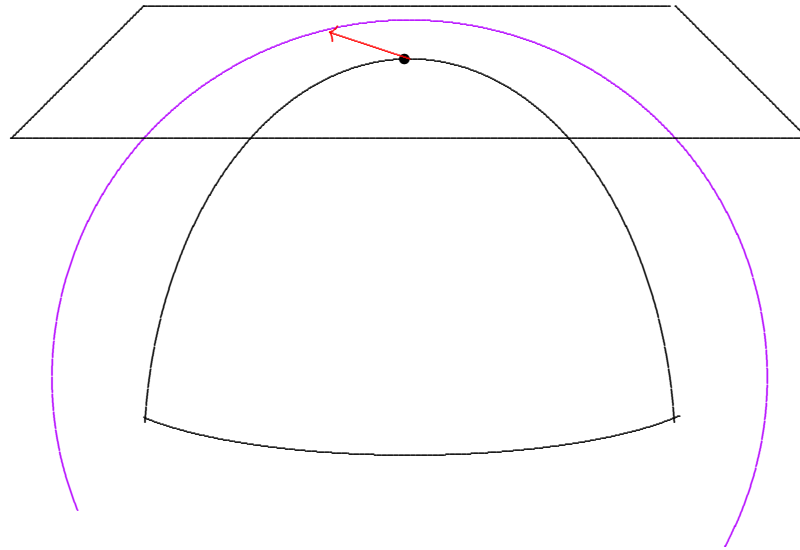

(M^n, g) :

holonomy

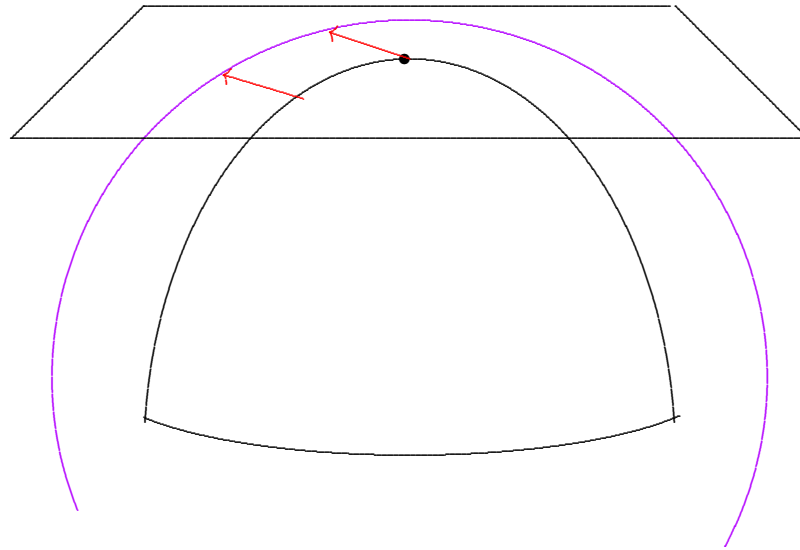

(M^n, g) :

holonomy

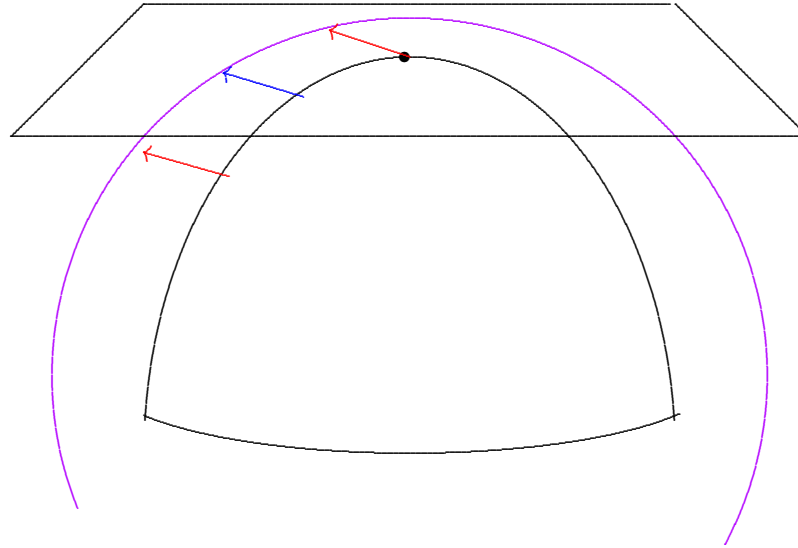

(M^n, g) :

holonomy

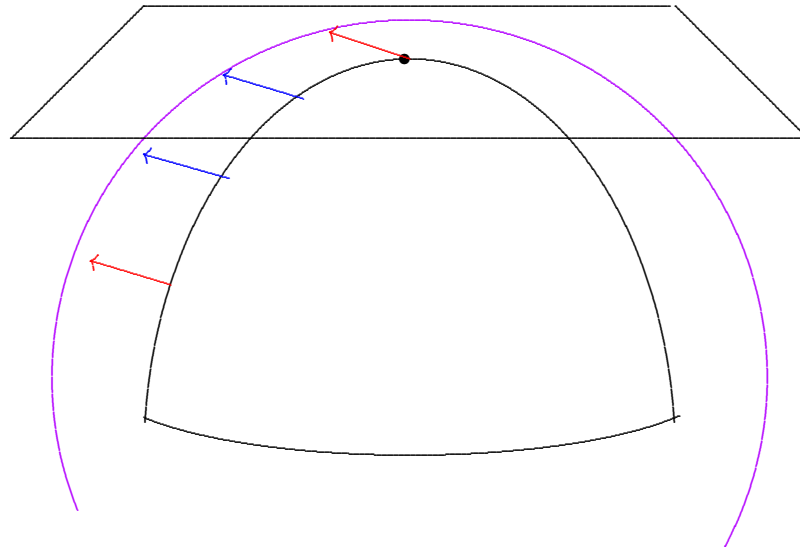

(M^n, g) :

holonomy

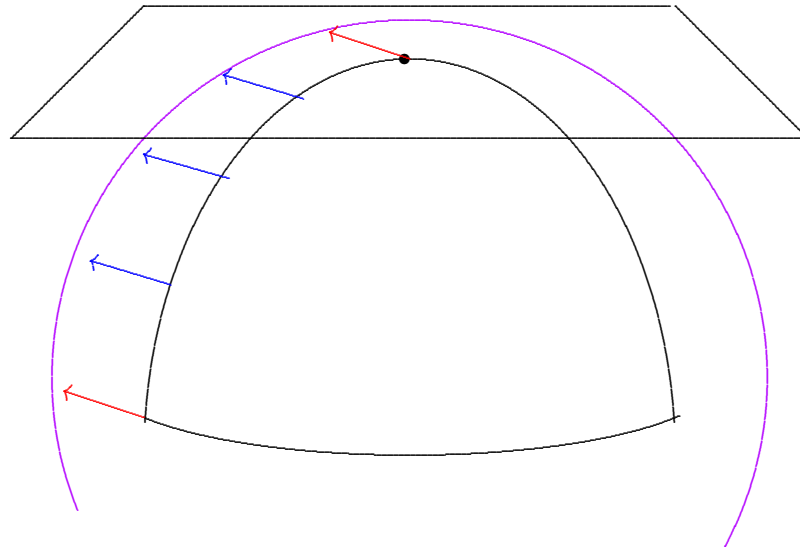

(M^n, g) :

holonomy

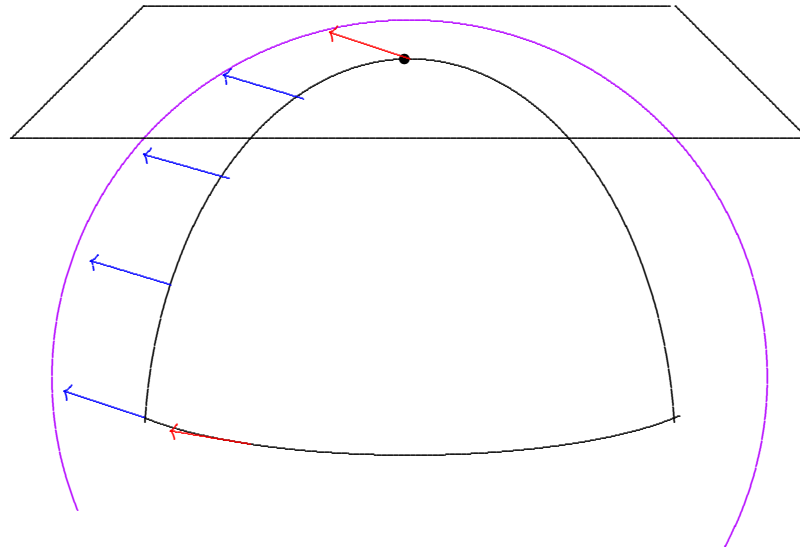

(M^n, g) :

holonomy

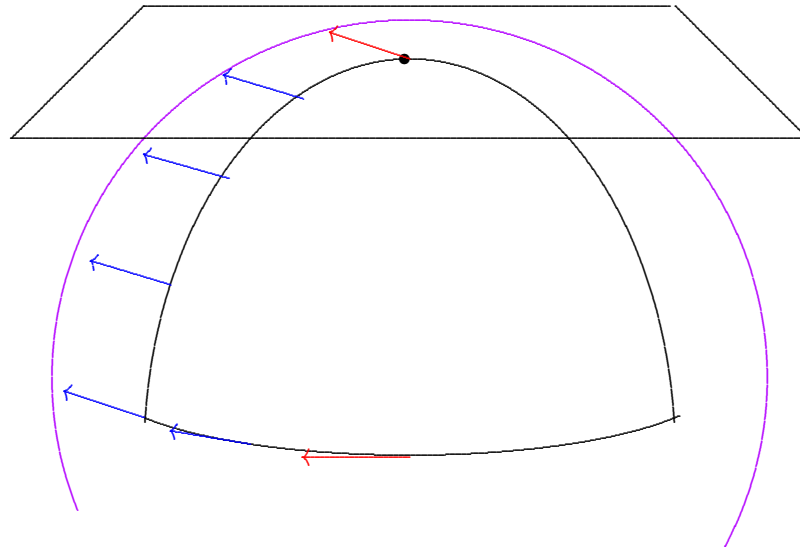

(M^n, g) :

holonomy

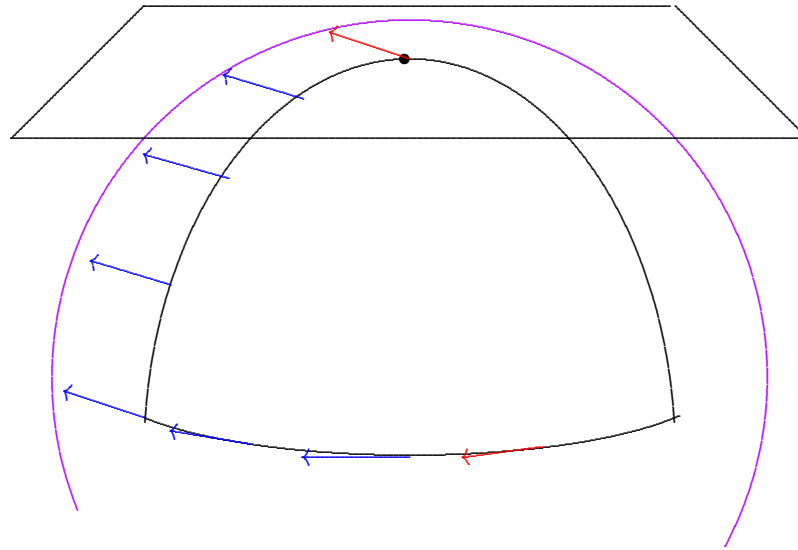

(M^n, g) :

holonomy

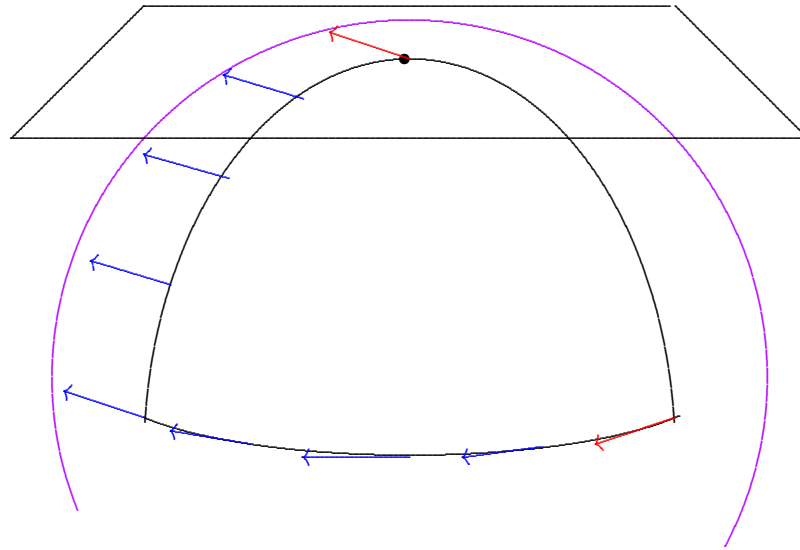

(M^n, g) :

holonomy

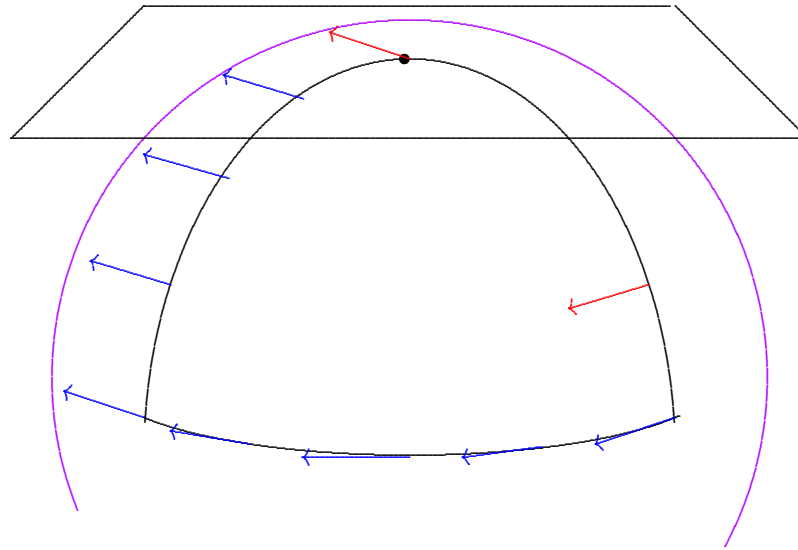

(M^n, g) :

holonomy

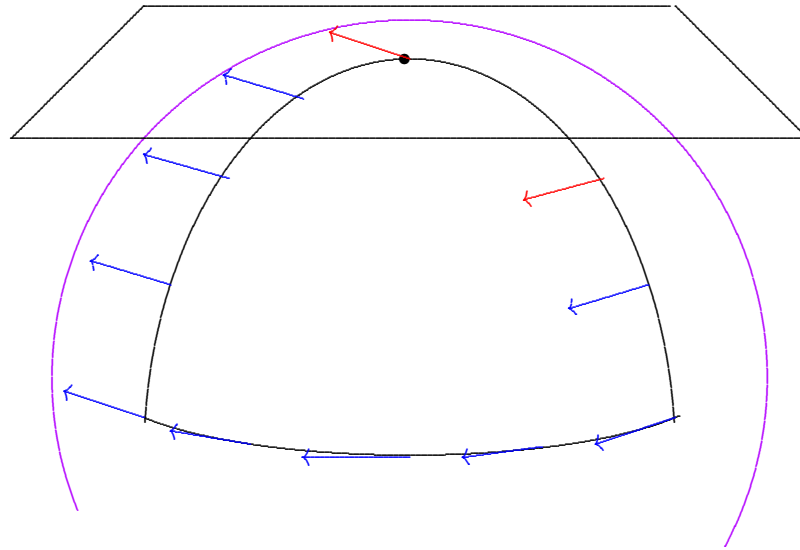

(M^n, g) :

holonomy

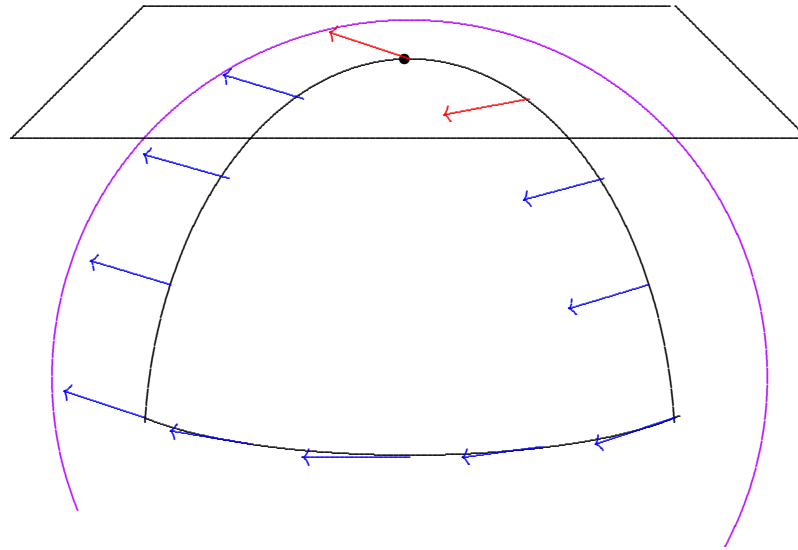

(M^n, g) :

holonomy

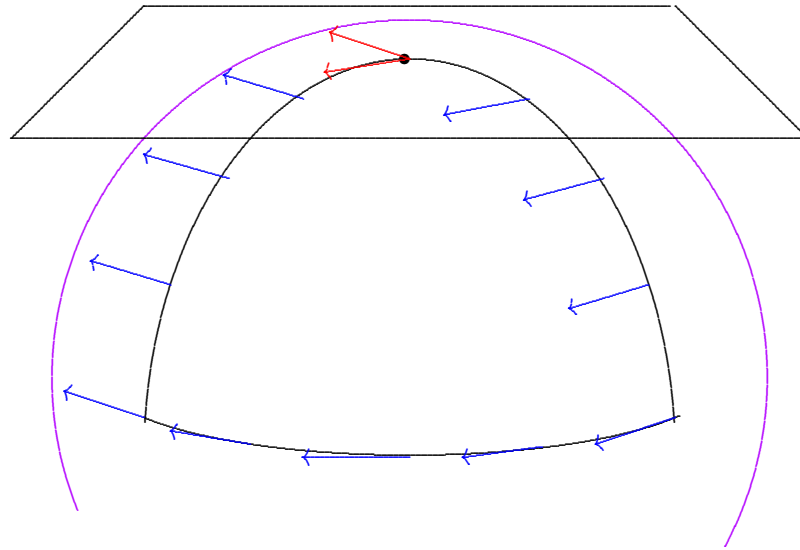

(M^n, g) :

holonomy

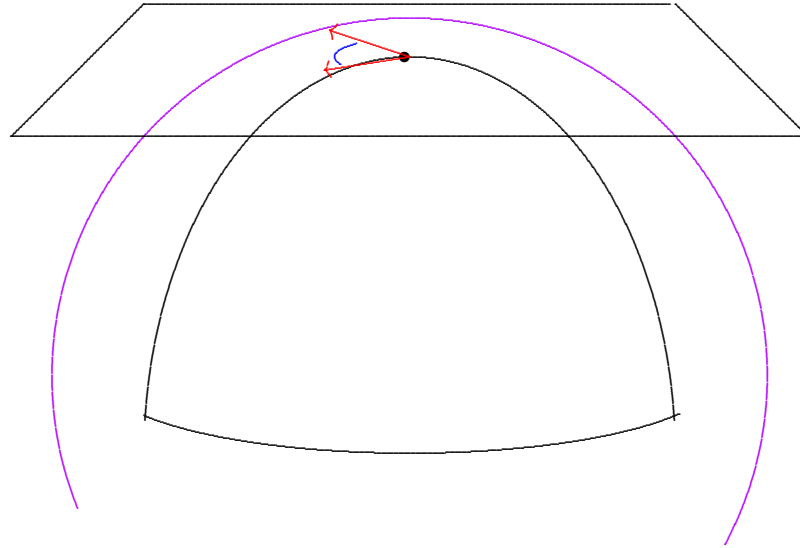

(M^n, g) :

holonomy $\subset \mathbf{O}(n)$

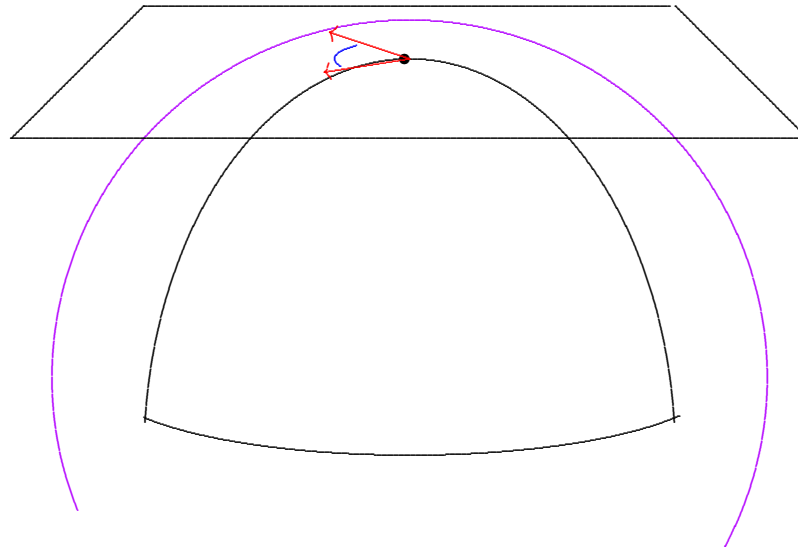

Kähler metrics:

(M^{2m}, g) :

holonomy

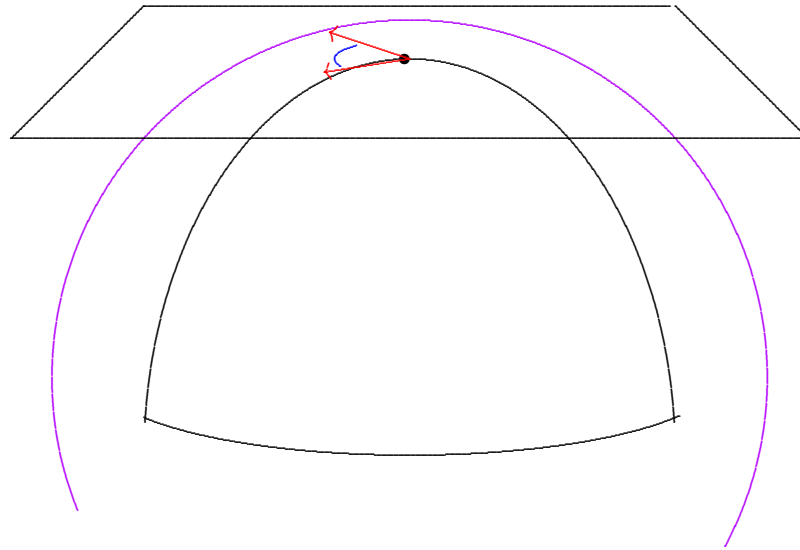

Kähler metrics:

(M^{2m}, g) Kähler \iff holonomy $\subset \mathbf{U}(m)$

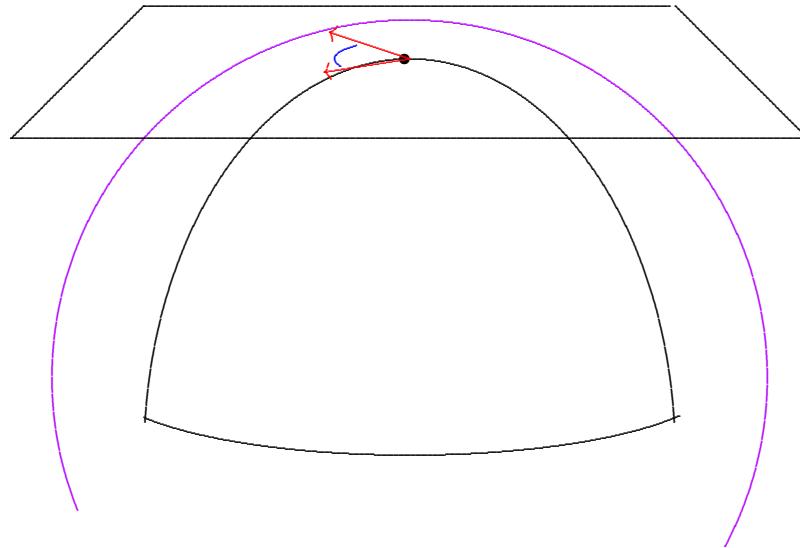

Kähler metrics:

(M^{2m}, g) Kähler \iff holonomy $\subset \mathbf{U}(m)$

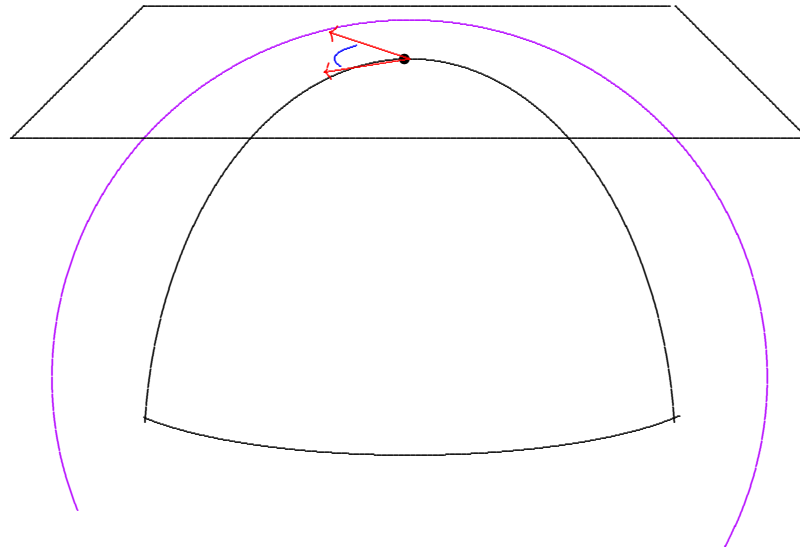

$$\mathbf{U}(m) := \mathbf{O}(2m) \cap \mathbf{GL}(m, \mathbb{C})$$

Kähler metrics:

(M^{2m}, g) Kähler \iff holonomy $\subset \mathbf{U}(m)$

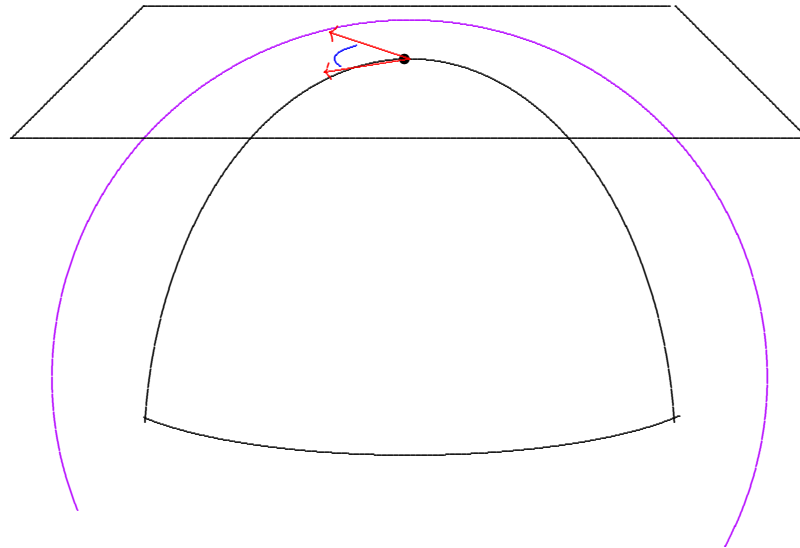

Makes tangent space a complex vector space!

Kähler metrics:

(M^{2m}, g) Kähler \iff holonomy $\subset \mathbf{U}(m)$

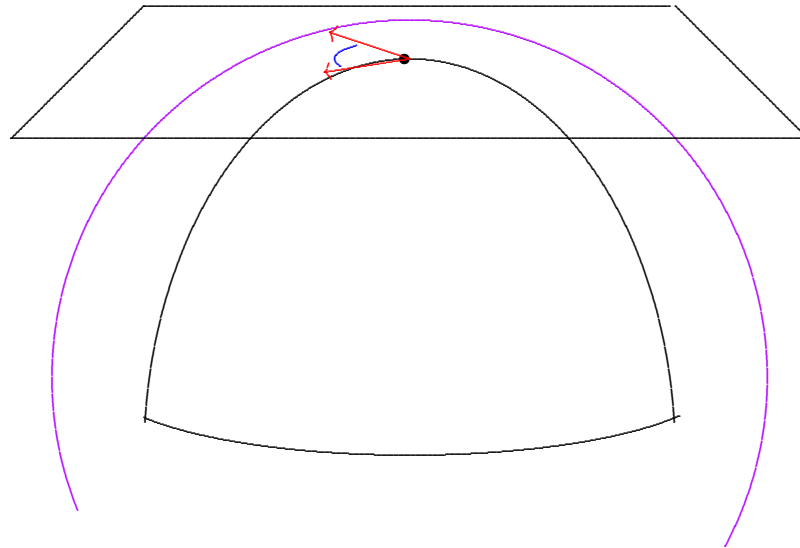

Makes tangent space a complex vector space!

$$J : TM \rightarrow TM, \quad J^2 = -\text{identity}$$

“almost-complex structure”

Kähler metrics:

(M^{2m}, g) Kähler \iff holonomy $\subset \mathbf{U}(m)$

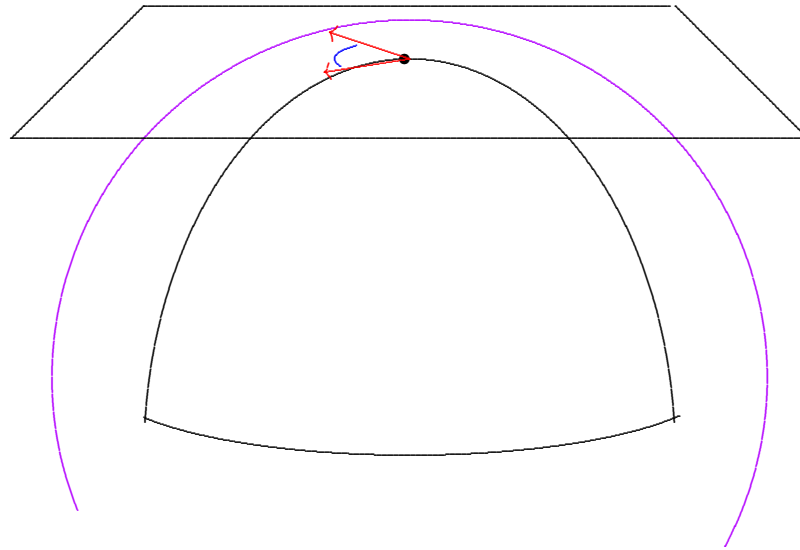

Makes tangent space a complex vector space!

Invariant under parallel transport!

Kähler metrics:

(M^{2m}, g) Kähler \iff holonomy $\subset \mathbf{U}(m)$

$\iff \exists$ almost complex-structure J with $\nabla J = 0$
and $g(J\cdot, J\cdot) = g$.

Kähler metrics:

(M^{2m}, g) Kähler \iff holonomy $\subset \mathbf{U}(m)$

$\iff \exists$ almost complex-structure J with $\nabla J = 0$
and $g(J\cdot, J\cdot) = g$.

$\iff (M^{2m}, g)$ is a complex manifold & $\exists J$ -invariant
closed 2-form ω such that $g = \omega(\cdot, J\cdot)$.

Kähler metrics:

(M^{2m}, g) Kähler \iff holonomy $\subset \mathbf{U}(m)$

$\iff \exists$ almost complex-structure J with $\nabla J = 0$
and $g(J\cdot, J\cdot) = g$.

$\iff (M^{2m}, g)$ is a complex manifold & $\exists J$ -invariant
closed 2-form ω such that $g = \omega(\cdot, J\cdot)$.

ω called “Kähler form.”

Kähler metrics:

(M^{2m}, g) Kähler \iff holonomy $\subset \mathbf{U}(m)$

$\iff \exists$ almost complex-structure J with $\nabla J = 0$
and $g(J\cdot, J\cdot) = g$.

$\iff (M^{2m}, g)$ is a complex manifold & $\exists J$ -invariant
closed 2-form ω such that $g = \omega(\cdot, J\cdot)$.

$$d\omega = 0$$

Kähler metrics:

(M^{2m}, g) Kähler \iff holonomy $\subset \mathbf{U}(m)$

$\iff \exists$ almost complex-structure J with $\nabla J = 0$
and $g(J\cdot, J\cdot) = g$.

$\iff (M^{2m}, g)$ is a complex manifold & $\exists J$ -invariant
closed 2-form ω such that $g = \omega(\cdot, J\cdot)$.

Kähler metrics:

(M^{2m}, g) Kähler \iff holonomy $\subset \mathbf{U}(m)$

$\iff \exists$ almost complex-structure J with $\nabla J = 0$
and $g(J\cdot, J\cdot) = g$.

$\iff (M^{2m}, g)$ is a complex manifold & $\exists J$ -invariant
closed 2-form ω such that $g = \omega(\cdot, J\cdot)$.

\iff In local complex coordinates (z^1, \dots, z^m) ,

$$g = - \sum_{j,k=1}^m \frac{\partial^2 f}{\partial z^j \partial \bar{z}^k} \left[dz^j \otimes d\bar{z}^k + d\bar{z}^k \otimes dz^j \right]$$

Kähler metrics:

(M^{2m}, g) Kähler \iff holonomy $\subset \mathbf{U}(m)$

$\iff \exists$ almost complex-structure J with $\nabla J = 0$
and $g(J\cdot, J\cdot) = g$.

$\iff (M^{2m}, g)$ is a complex manifold & $\exists J$ -invariant
closed 2-form ω such that $g = \omega(\cdot, J\cdot)$.

\iff In local complex coordinates (z^1, \dots, z^m) , $\exists f(z)$

$$g = - \sum_{j,k=1}^m \frac{\partial^2 f}{\partial z^j \partial \bar{z}^k} \left[dz^j \otimes d\bar{z}^k + d\bar{z}^k \otimes dz^j \right]$$

Kähler metrics:

(M^{2m}, g) Kähler \iff holonomy $\subset \mathbf{U}(m)$

$\iff \exists$ almost complex-structure J with $\nabla J = 0$
and $g(J\cdot, J\cdot) = g$.

$\iff (M^{2m}, g)$ is a complex manifold & $\exists J$ -invariant
closed 2-form ω such that $g = \omega(\cdot, J\cdot)$.

\iff In local complex coordinates (z^1, \dots, z^m) , $\exists f(z)$

$$\omega = i \sum_{j,k=1}^m \frac{\partial^2 f}{\partial z^j \partial \bar{z}^k} dz^j \wedge d\bar{z}^k$$

Kähler metrics:

(M^{2m}, g) Kähler \iff holonomy $\subset \mathbf{U}(m)$

$\iff \exists$ almost complex-structure J with $\nabla J = 0$
and $g(J\cdot, J\cdot) = g$.

$\iff (M^{2m}, g)$ is a complex manifold & $\exists J$ -invariant
closed 2-form ω such that $g = \omega(\cdot, J\cdot)$.

\iff In local complex coordinates (z^1, \dots, z^m) , $\exists f(z)$

$$g = - \sum_{j,k=1}^m \frac{\partial^2 f}{\partial z^j \partial \bar{z}^k} \left[dz^j \otimes d\bar{z}^k + d\bar{z}^k \otimes dz^j \right]$$

Kähler metrics:

(M^{2m}, g) Kähler \iff holonomy $\subset \mathbf{U}(m)$

$\iff \exists$ almost complex-structure J with $\nabla J = 0$
and $g(J\cdot, J\cdot) = g$.

$\iff (M^{2m}, g)$ is a complex manifold & $\exists J$ -invariant
closed 2-form ω such that $g = \omega(\cdot, J\cdot)$.

Kähler magic:

$$r = - \sum_{j,k=1}^m \frac{\partial^2}{\partial z^j \partial \bar{z}^k} \log \det[g_{p\bar{q}}] \left[dz^j \otimes d\bar{z}^k + d\bar{z}^k \otimes dz^j \right]$$

Kähler metrics:

(M^{2m}, g) Kähler \iff holonomy $\subset \mathbf{U}(m)$

$\iff \exists$ almost complex-structure J with $\nabla J = 0$
and $g(J\cdot, J\cdot) = g$.

$\iff (M^{2m}, g)$ is a complex manifold & $\exists J$ -invariant
closed 2-form ω such that $g = \omega(\cdot, J\cdot)$.

Kähler magic:

If we define the Ricci form by

$$\rho = r(J\cdot, \cdot)$$

then $i\rho$ is curvature of canonical line bundle $\Lambda^{m,0}$.

Kähler metrics:

(M^{2m}, g) Kähler \iff holonomy $\subset \mathbf{U}(m)$

$\iff \exists$ almost complex-structure J with $\nabla J = 0$
and $g(J\cdot, J\cdot) = g$.

$\iff (M^{2m}, g)$ is a complex manifold & $\exists J$ -invariant
closed 2-form ω such that $g = \omega(\cdot, J\cdot)$.

ω called “Kähler form.”

Kähler metrics:

(M^{2m}, g) Kähler \iff holonomy $\subset \mathbf{U}(m)$

$\iff \exists$ almost complex-structure J with $\nabla J = 0$
and $g(J\cdot, J\cdot) = g$.

$\iff (M^{2m}, g)$ is a complex manifold & $\exists J$ -invariant
closed 2-form ω such that $g = \omega(\cdot, J\cdot)$.

$$d\omega = 0$$

Kähler metrics:

(M^{2m}, g) Kähler \iff holonomy $\subset \mathbf{U}(m)$

$\iff \exists$ almost complex-structure J with $\nabla J = 0$
and $g(J\cdot, J\cdot) = g$.

$\iff (M^{2m}, g)$ is a complex manifold & $\exists J$ -invariant
closed 2-form ω such that $g = \omega(\cdot, J\cdot)$.

$$[\omega] \in H^2(M)$$

“Kähler class”

Kähler metrics:

(M^{2m}, g) Kähler \iff holonomy $\subset \mathbf{U}(m)$

$\iff \exists$ almost complex-structure J with $\nabla J = 0$
and $g(J\cdot, J\cdot) = g$.

$\iff (M^{2m}, g)$ is a complex manifold & $\exists J$ -invariant
closed 2-form ω such that $g = \omega(\cdot, J\cdot)$.

$$d\omega = 0$$

ω non-degenerate closed 2-form:

Kähler metrics:

(M^{2m}, g) Kähler \iff holonomy $\subset \mathbf{U}(m)$

$\iff \exists$ almost complex-structure J with $\nabla J = 0$
and $g(J\cdot, J\cdot) = g$.

$\iff (M^{2m}, g)$ is a complex manifold & $\exists J$ -invariant
closed 2-form ω such that $g = \omega(\cdot, J\cdot)$.

$$d\omega = 0$$

ω non-degenerate closed 2-form: symplectic form

Motivation:

When $n = 3$, ADM mass in general relativity.

Reads off “apparent mass” from strength of the gravitational field far from an isolated source.

In any dimension, reproduces “mass” of $t = 0$ hypersurface in $(n + 1)$ -dimensional Schwarzschild

$$g = \left(1 - \frac{2m}{\varrho^{n-2}}\right)^{-1} d\varrho^2 + \varrho^2 h_{S^{n-1}}$$

Scalar-flat-Kähler Burns metric on $\widetilde{\mathbb{C}^2} \subset \mathbb{C}^2 \times \mathbb{CP}_1$

Motivation:

When $n = 3$, ADM mass in general relativity.

Reads off “apparent mass” from strength of the gravitational field far from an isolated source.

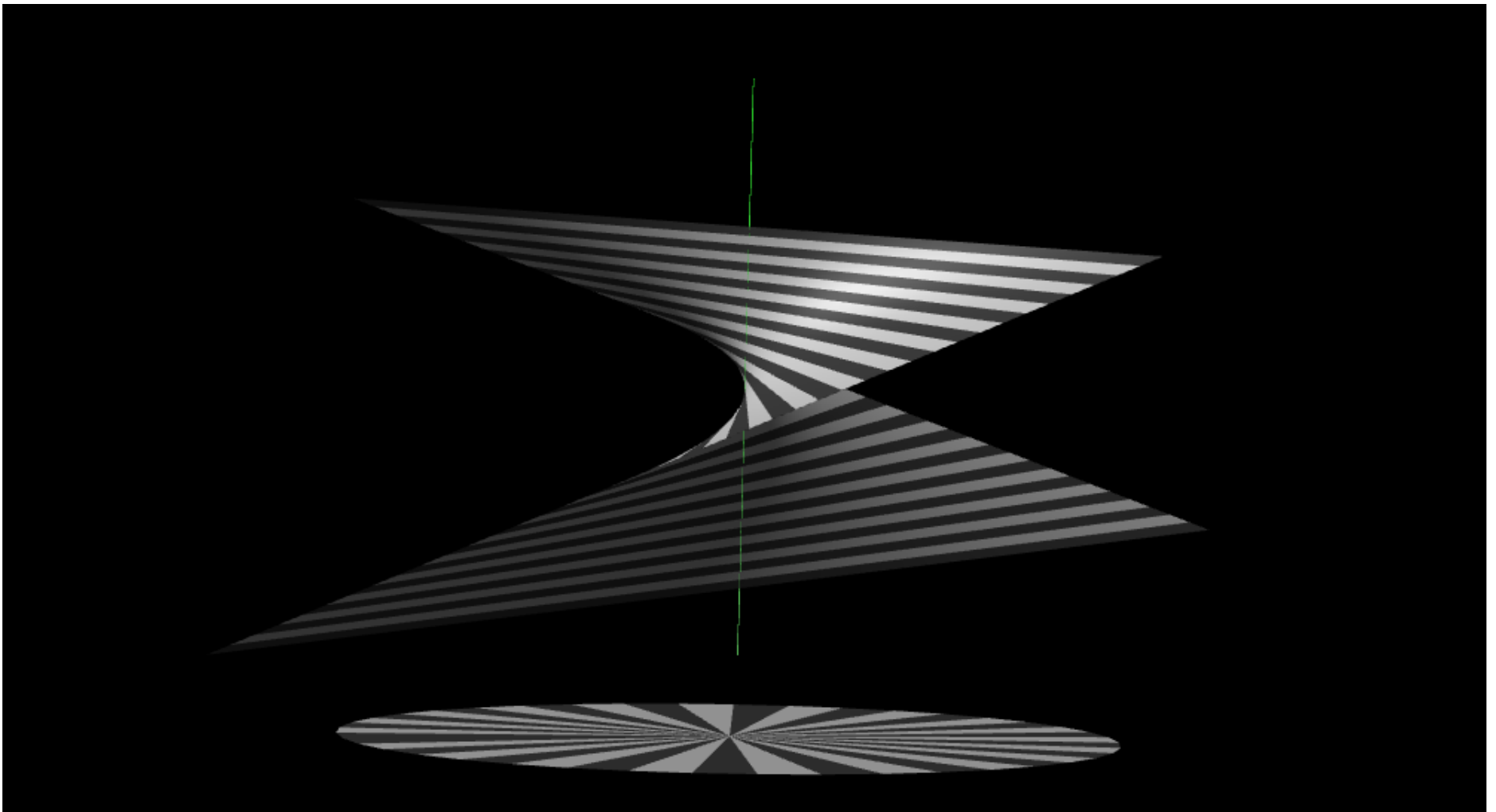

Motivation:

When $n = 3$, ADM mass in general relativity.

Reads off “apparent mass” from strength of the gravitational field far from an isolated source.

In any dimension, reproduces “mass” of $t = 0$ hypersurface in $(n + 1)$ -dimensional Schwarzschild

$$g = \left(1 - \frac{2m}{\rho^{n-2}}\right)^{-1} d\rho^2 + \rho^2 h_{S^{n-1}}$$

Scalar-flat-Kähler Burns metric on $\widetilde{\mathbb{C}^2} \subset \mathbb{C}^2 \times \mathbb{CP}_1$:

Restrict Euclidean \times round metric to $\begin{vmatrix} z_1 & z_2 \\ \zeta_1 & \zeta_2 \end{vmatrix} = 0$.

Motivation:

When $n = 3$, ADM mass in general relativity.

Reads off “apparent mass” from strength of the gravitational field far from an isolated source.

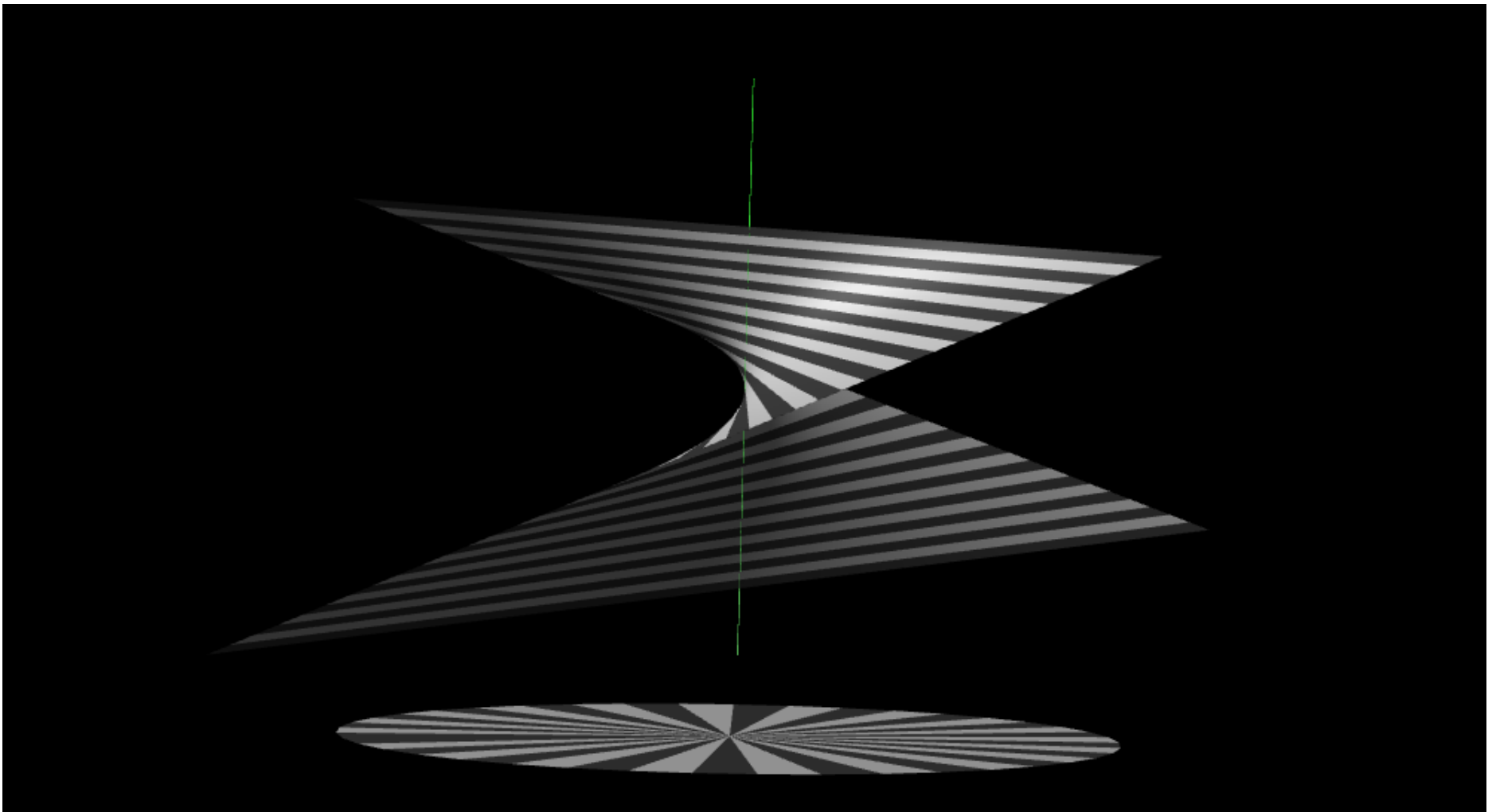

Motivation:

When $n = 3$, ADM mass in general relativity.

Reads off “apparent mass” from strength of the gravitational field far from an isolated source.

In any dimension, reproduces “mass” of $t = 0$ hypersurface in $(n + 1)$ -dimensional Schwarzschild

$$g = \left(1 - \frac{2m}{\varrho^{n-2}}\right)^{-1} d\varrho^2 + \varrho^2 h_{S^{n-1}}$$

Scalar-flat-Kähler Burns metric on $\widetilde{\mathbb{C}^2} \subset \mathbb{C}^2 \times \mathbb{CP}_1$:

Restrict Euclidean \times round metric to $\begin{vmatrix} z_1 & z_2 \\ \zeta_1 & \zeta_2 \end{vmatrix} = 0$.

Motivation:

When $n = 3$, ADM mass in general relativity.

Reads off “apparent mass” from strength of the gravitational field far from an isolated source.

In any dimension, reproduces “mass” of $t = 0$ hypersurface in $(n + 1)$ -dimensional Schwarzschild

$$g = \left(1 - \frac{2m}{\rho^{n-2}}\right)^{-1} d\rho^2 + \rho^2 h_{S^{n-1}}$$

Scalar-flat-Kähler Burns metric on $\widetilde{\mathbb{C}^2} \subset \mathbb{C}^2 \times \mathbb{CP}_1$:

Restrict Euclidean \times round metric to $\begin{vmatrix} z_1 & z_2 \\ \zeta_1 & \zeta_2 \end{vmatrix} = 0$.

Motivation:

When $n = 3$, ADM mass in general relativity.

Reads off “apparent mass” from strength of the gravitational field far from an isolated source.

In any dimension, reproduces “mass” of $t = 0$ hypersurface in $(n + 1)$ -dimensional Schwarzschild

$$g = \left(1 - \frac{2m}{\varrho^{n-2}}\right)^{-1} d\varrho^2 + \varrho^2 h_{S^{n-1}}$$

Scalar-flat-Kähler Burns metric on $\widetilde{\mathbb{C}^2} \subset \mathbb{C}^2 \times \mathbb{CP}_1$:

$$\omega = \frac{i}{2} \partial \bar{\partial} [u + 3m \log u],$$

Motivation:

When $n = 3$, ADM mass in general relativity.

Reads off “apparent mass” from strength of the gravitational field far from an isolated source.

In any dimension, reproduces “mass” of $t = 0$ hypersurface in $(n + 1)$ -dimensional Schwarzschild

$$g = \left(1 - \frac{2m}{\rho^{n-2}}\right)^{-1} d\rho^2 + \rho^2 h_{S^{n-1}}$$

Scalar-flat-Kähler Burns metric on $\widetilde{\mathbb{C}^2} \subset \mathbb{C}^2 \times \mathbb{CP}_1$:

$$\omega = \frac{i}{2} \partial \bar{\partial} [u + 3m \log u], \quad u = |z_1|^2 + |z_2|^2$$

Motivation:

When $n = 3$, ADM mass in general relativity.

Reads off “apparent mass” from strength of the gravitational field far from an isolated source.

In any dimension, reproduces “mass” of $t = 0$ hypersurface in $(n + 1)$ -dimensional Schwarzschild

$$g = \left(1 - \frac{2m}{\varrho^{n-2}}\right)^{-1} d\varrho^2 + \varrho^2 h_{S^{n-1}}$$

Scalar-flat-Kähler Burns metric on $\widetilde{\mathbb{C}^2} \subset \mathbb{C}^2 \times \mathbb{CP}_1$:

$$\omega = \frac{i}{2} \partial \bar{\partial} [u + 3m \log u], \quad u = |z_1|^2 + |z_2|^2$$

also has mass m .

Motivation:

When $n = 3$, ADM mass in general relativity.

Reads off “apparent mass” from strength of the gravitational field far from an isolated source.

In any dimension, reproduces “mass” of $t = 0$ hypersurface in $(n + 1)$ -dimensional Schwarzschild

$$g = \left(1 - \frac{2m}{\varrho^{n-2}}\right)^{-1} d\varrho^2 + \varrho^2 h_{S^{n-1}}$$

Scalar-flat-Kähler Burns metric on $\widetilde{\mathbb{C}^2} \subset \mathbb{C}^2 \times \mathbb{CP}_1$:

$$\omega = \frac{i}{2} \partial \bar{\partial} [u + 3m \log u], \quad u = |z_1|^2 + |z_2|^2$$

also has mass m . Again measures “size of throat.”

Definition. A complete, non-compact Riemannian n -manifold (M^n, g) is called **asymptotically Euclidean (AE)** if there is a compact set $K \subset M$ such that each “end” is diffeomorphic to $\mathbb{R}^n - D^n$ in such a manner that

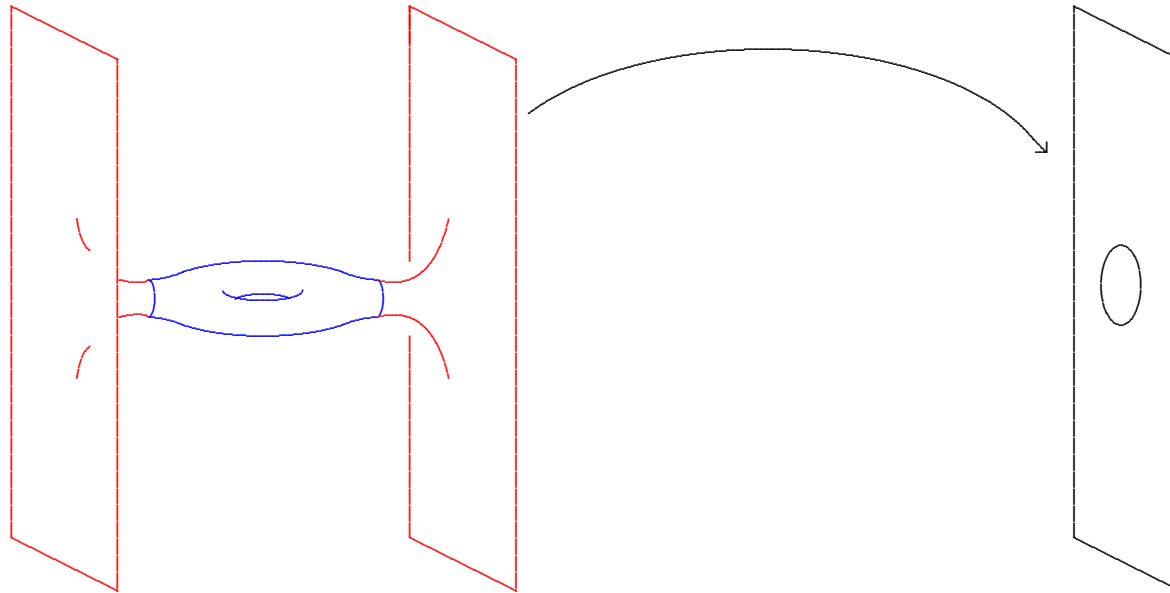

$$g_{jk} = \delta_{jk} + O(|x|^{1-\frac{n}{2}-\varepsilon})$$

$$g_{jk,\ell} = O(|x|^{-\frac{n}{2}-\varepsilon}), \quad s \in L^1$$

Interesting generalization...

Definition. Complete, non-compact n -manifold (M^n, g) is asymptotically locally Euclidean

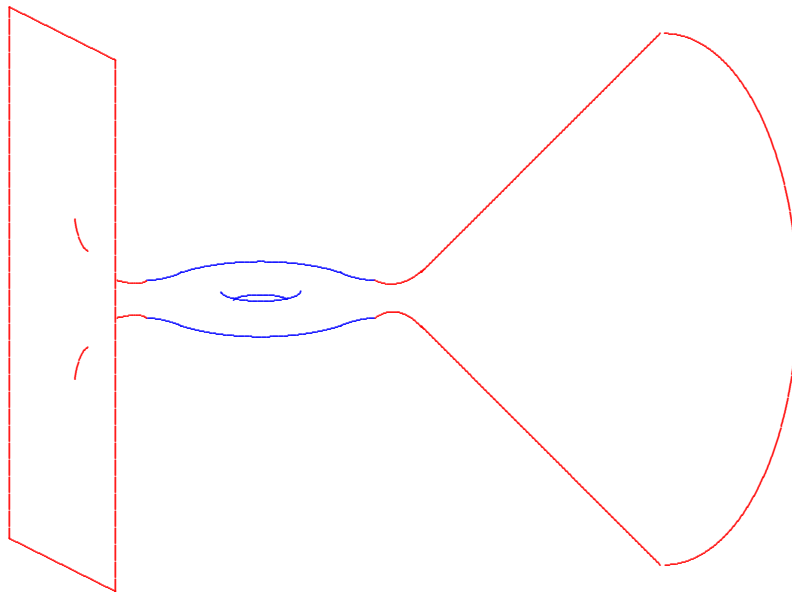

Definition. Complete, non-compact n -manifold (M^n, g) is asymptotically locally Euclidean (ALE)

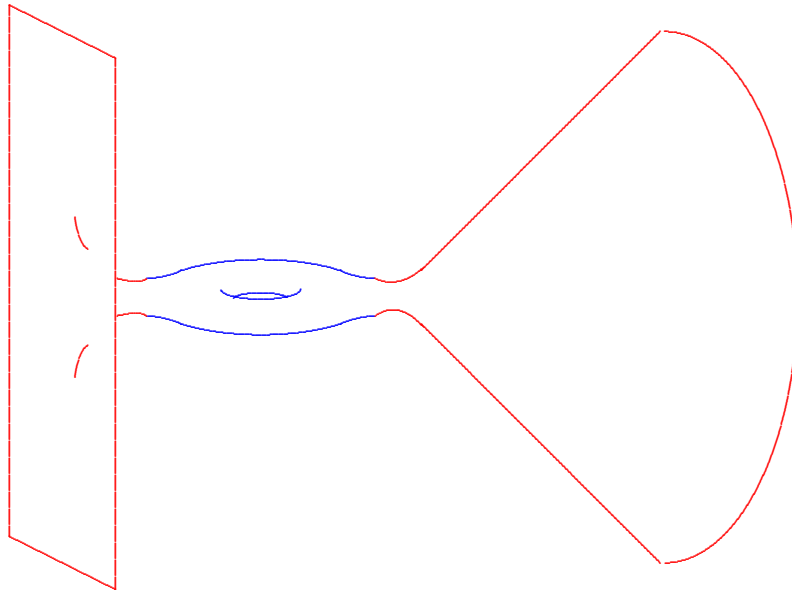

Definition. Complete, non-compact n -manifold (M^n, g) is asymptotically locally Euclidean (ALE) if \exists compact set $K \subset M$

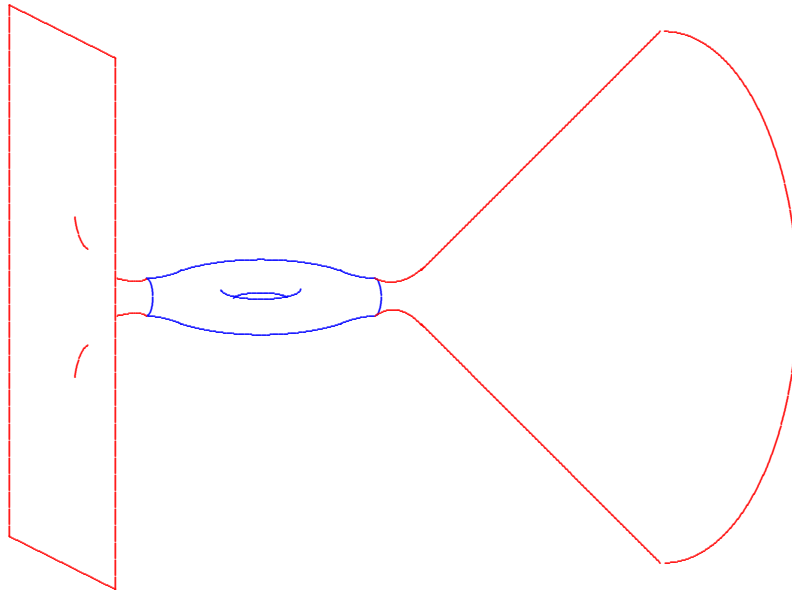

Definition. Complete, non-compact n -manifold (M^n, g) is asymptotically locally Euclidean (ALE) if \exists compact set $K \subset M$ such that $M - K \approx \coprod_i (\mathbb{R}^n - D^n) / \Gamma_i$,

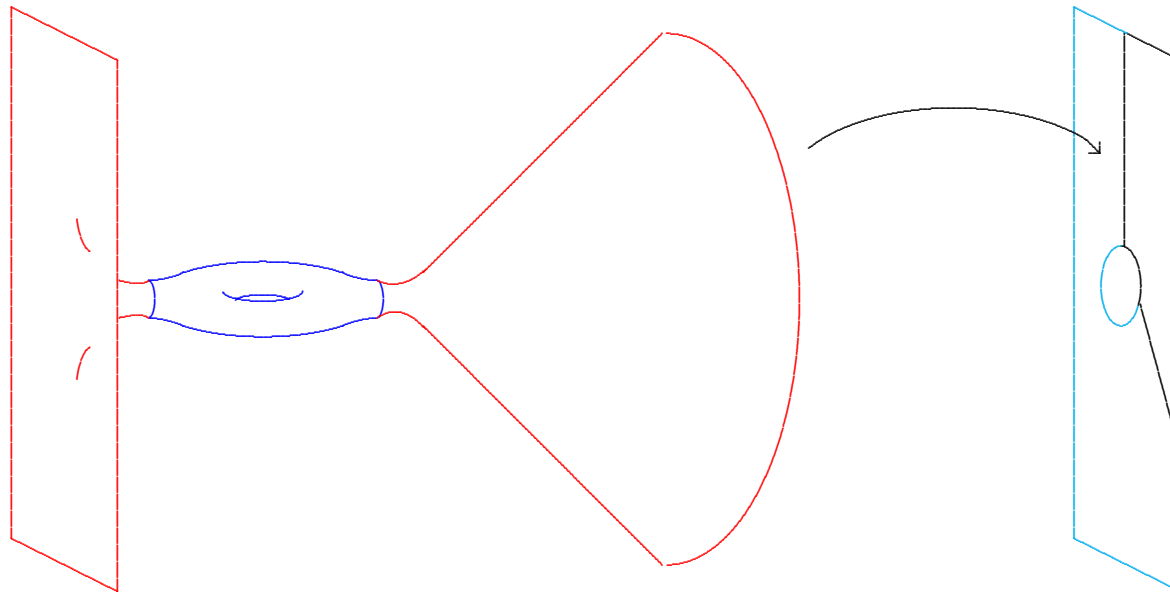

Definition. Complete, non-compact n -manifold (M^n, g) is asymptotically locally Euclidean (ALE) if \exists compact set $K \subset M$ such that $M - K \approx \coprod_i (\mathbb{R}^n - D^n) / \Gamma_i$, where $\Gamma_i \subset \mathbf{O}(n)$,

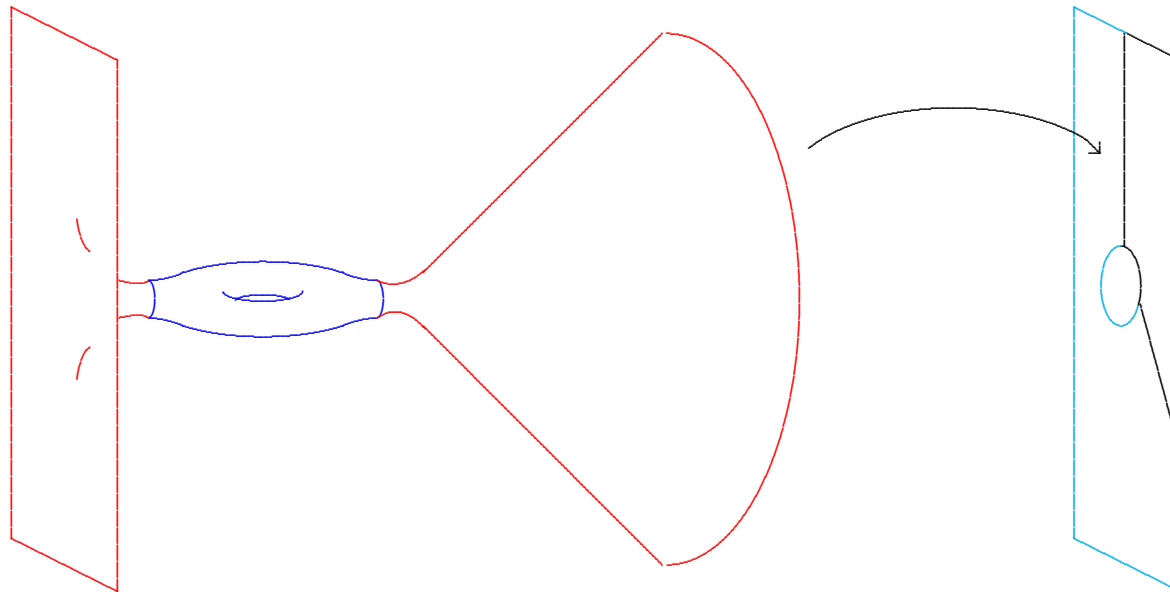

Definition. Complete, non-compact n -manifold (M^n, g) is asymptotically locally Euclidean (ALE) if \exists compact set $K \subset M$ such that $M - K \approx \coprod_i (\mathbb{R}^n - D^n) / \Gamma_i$, where $\Gamma_i \subset \mathbf{O}(n)$,

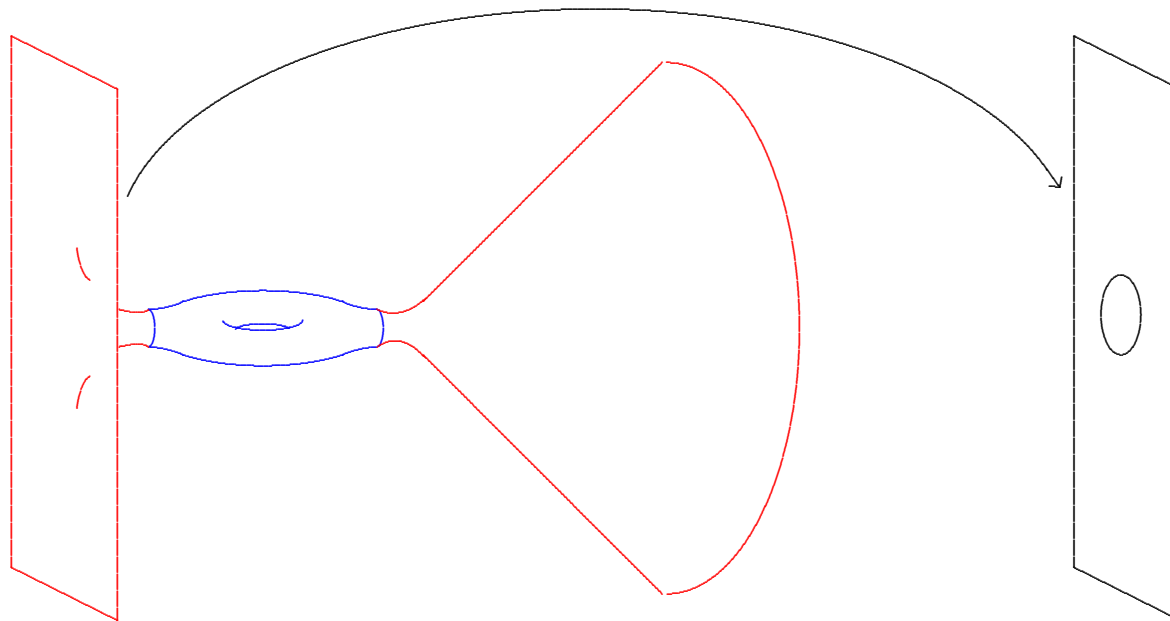

Definition. Complete, non-compact n -manifold (M^n, g) is asymptotically locally Euclidean (ALE) if \exists compact set $K \subset M$ such that $M - K \approx \coprod_i (\mathbb{R}^n - D^n) / \Gamma_i$, where $\Gamma_i \subset \mathbf{O}(n)$,

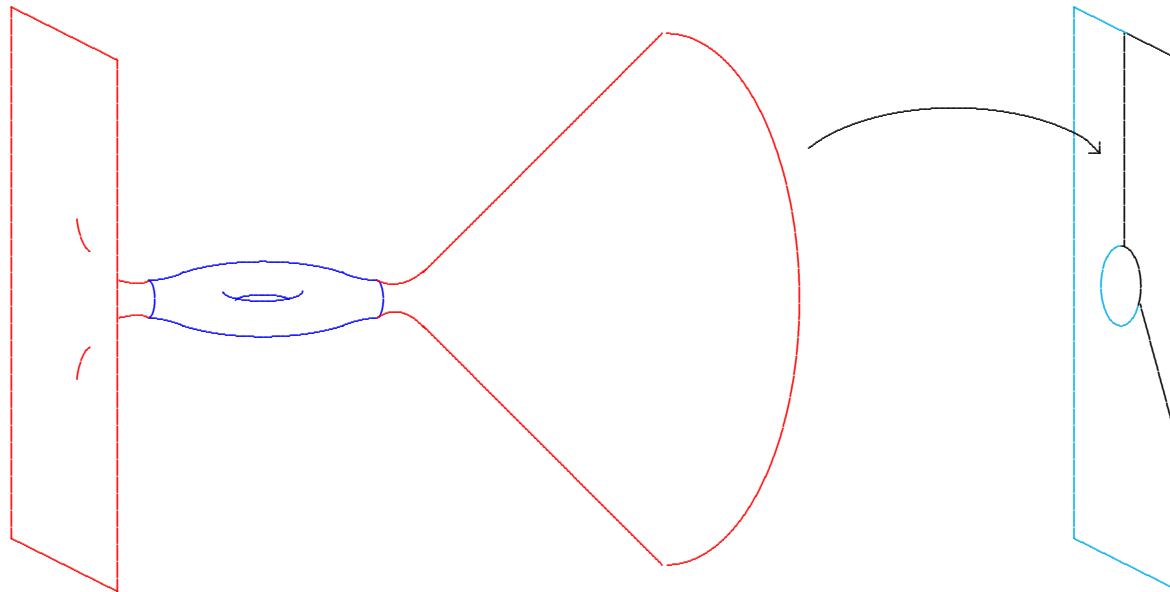

Definition. Complete, non-compact n -manifold (M^n, g) is asymptotically locally Euclidean (ALE) if \exists compact set $K \subset M$ such that $M - K \approx \coprod_i (\mathbb{R}^n - D^n) / \Gamma_i$, where $\Gamma_i \subset \mathbf{O}(n)$, such that

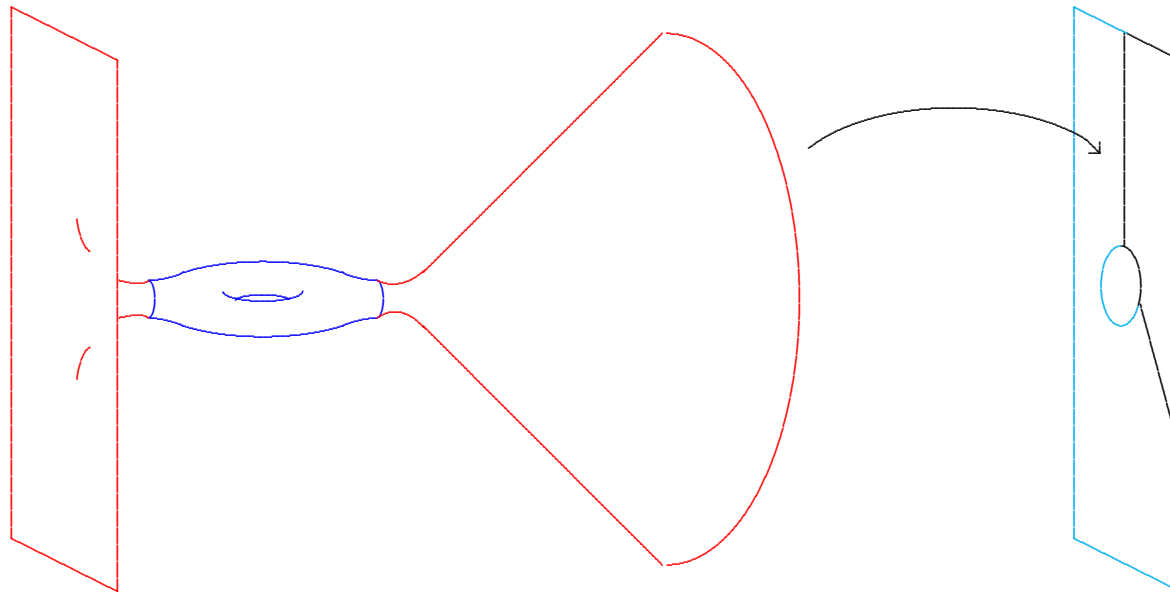

$$g_{jk} = \delta_{jk} + O(|x|^{1-\frac{n}{2}-\varepsilon})$$

$$g_{jk,\ell} = O(|x|^{-\frac{n}{2}-\varepsilon}), \quad s \in L^1$$

Why consider *ALE* spaces?

Key examples:

Key examples:

Gravitational Instantons:

Key examples:

Gravitational Instantons:

ALE Ricci-flat Kähler manifolds.

Key examples:

Gravitational Instantons:

Bubbling modes for sequences of Einstein metrics.

Key examples:

Gravitational Instantons:

Bubbling modes for sequences of Einstein metrics.

ALE scalar-flat Kähler surfaces:

Key examples:

Gravitational Instantons:

Bubbling modes for sequences of Einstein metrics.

ALE scalar-flat Kähler surfaces:

Bubbling modes for extremal Kähler metrics.

Key examples:

Gravitational Instantons:

Bubbling modes for sequences of Einstein metrics.

ALE scalar-flat Kähler surfaces:

Bubbling modes for extremal Kähler metrics.

Theory used to construct compact Einstein 4-manifolds.

Key examples:

Gravitational Instantons:

Bubbling modes for sequences of Einstein metrics.

ALE scalar-flat Kähler surfaces:

Bubbling modes for extremal Kähler metrics.

Theory used to construct compact Einstein 4-manifolds.

Chen-L-Weber '08.

Definition. Complete, non-compact n -manifold (M^n, g) is asymptotically locally Euclidean (ALE) if \exists compact set $K \subset M$ such that $M - K \approx \coprod_i (\mathbb{R}^n - D^n) / \Gamma_i$, where $\Gamma_i \subset \mathbf{O}(n)$, such that

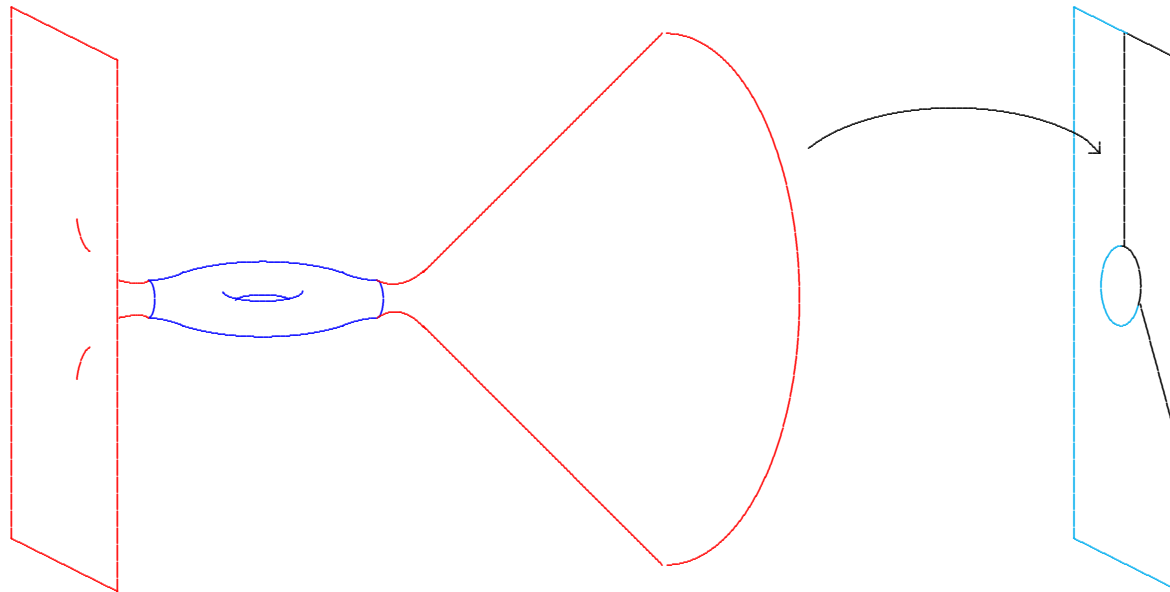

$$g_{jk} = \delta_{jk} + O(|x|^{1-\frac{n}{2}-\varepsilon})$$

$$g_{jk,\ell} = O(|x|^{-\frac{n}{2}-\varepsilon}), \quad s \in L^1$$

Mass still meaningful in this context...

Definition. *The mass (at a given end) of an ALE n -manifold is defined to be*

$$m(M, g) := [g_{ij,i} - g_{ii,j}]$$

Definition. *The mass (at a given end) of an ALE n -manifold is defined to be*

$$m(M, g) := \int_{\partial M} [g_{ij,i} - g_{ii,j}] \nu^j$$

Definition. *The mass (at a given end) of an ALE n -manifold is defined to be*

$$m(M, g) := \int_{\Sigma(\varrho)} [g_{ij,i} - g_{ii,j}] \nu^j \alpha_E$$

Definition. *The mass (at a given end) of an ALE n -manifold is defined to be*

$$m(M, g) := \lim_{\varrho \rightarrow \infty} \int_{\Sigma(\varrho)} [g_{ij,i} - g_{ii,j}] \nu^j \alpha_E$$

Definition. *The mass (at a given end) of an ALE n -manifold is defined to be*

$$m(M, g) := \lim_{\varrho \rightarrow \infty} \frac{\Gamma(\frac{n}{2})}{4(n-1)\pi^{n/2}} \int_{\Sigma(\varrho)} [g_{ij,i} - g_{ii,j}] \nu^j \alpha_E$$

Definition. *The mass (at a given end) of an ALE n -manifold is defined to be*

$$m(M, g) := \lim_{\varrho \rightarrow \infty} \frac{\Gamma(\frac{n}{2})}{4(n-1)\pi^{n/2}} \int_{\Sigma(\varrho)} [g_{ij,i} - g_{ii,j}] \nu^j \alpha_E$$

where

Definition. The mass (at a given end) of an *ALE* n -manifold is defined to be

$$m(M, g) := \lim_{\varrho \rightarrow \infty} \frac{\Gamma(\frac{n}{2})}{4(n-1)\pi^{n/2}} \int_{\Sigma(\varrho)} [g_{ij,i} - g_{ii,j}] \nu^j \alpha_E$$

where

- $\Sigma(\varrho) \approx S^{n-1}/\Gamma_i$

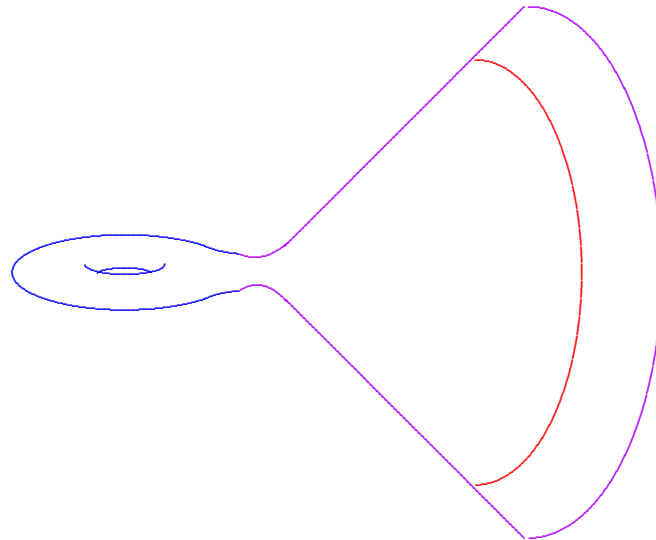

Definition. *The mass (at a given end) of an ALE n -manifold is defined to be*

$$m(M, g) := \lim_{\varrho \rightarrow \infty} \frac{\Gamma(\frac{n}{2})}{4(n-1)\pi^{n/2}} \int_{\Sigma(\varrho)} [g_{ij,i} - g_{ii,j}] \nu^j \alpha_E$$

where

- $\Sigma(\varrho) \approx S^{n-1}/\Gamma_i$ is given by $|\vec{x}| = \varrho$;

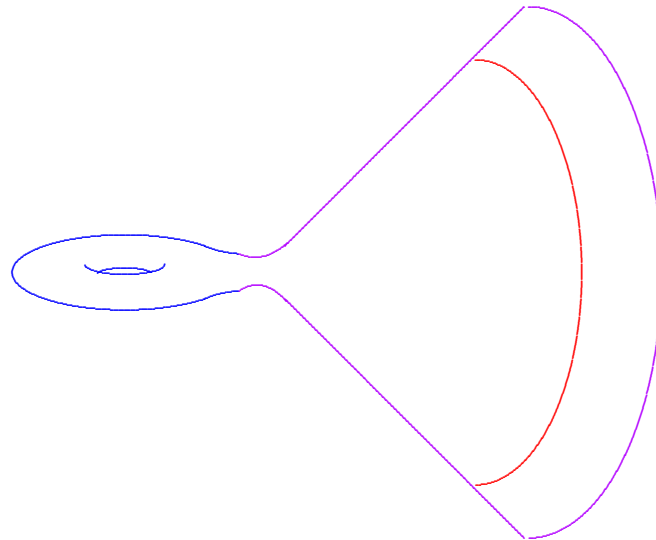

Definition. *The mass (at a given end) of an ALE n -manifold is defined to be*

$$m(M, g) := \lim_{\varrho \rightarrow \infty} \frac{\Gamma(\frac{n}{2})}{4(n-1)\pi^{n/2}} \int_{\Sigma(\varrho)} [g_{ij,i} - g_{ii,j}] \nu^j \alpha_E$$

where

- $\Sigma(\varrho) \approx S^{n-1}/\Gamma_i$ is given by $|\vec{x}| = \varrho$;
- ν is the outpointing Euclidean unit normal;

Definition. *The mass (at a given end) of an ALE n -manifold is defined to be*

$$m(M, g) := \lim_{\varrho \rightarrow \infty} \frac{\Gamma(\frac{n}{2})}{4(n-1)\pi^{n/2}} \int_{\Sigma(\varrho)} [g_{ij,i} - g_{ii,j}] \nu^j \alpha_E$$

where

- $\Sigma(\varrho) \approx S^{n-1}/\Gamma_i$ is given by $|\vec{x}| = \varrho$;
- ν is the outpointing Euclidean unit normal;
and
- α_E is the volume $(n-1)$ -form induced by the Euclidean metric.

Definition. *The mass (at a given end) of an ALE n -manifold is defined to be*

$$m(M, g) := \lim_{\varrho \rightarrow \infty} \frac{\Gamma(\frac{n}{2})}{4(n-1)\pi^{n/2}} \int_{\Sigma(\varrho)} [g_{ij,i} - g_{ii,j}] \nu^j \alpha_E$$

where

- $\Sigma(\varrho) \approx S^{n-1}/\Gamma_i$ is given by $|\vec{x}| = \varrho$;
- ν is the outpointing Euclidean unit normal;
and
- α_E is the volume $(n-1)$ -form induced by the Euclidean metric.

Bartnik/Chruściel (1986): With weak fall-off conditions, the mass is well-defined & coordinate independent.

Definition. *The mass (at a given end) of an ALE n -manifold is defined to be*

$$m(M, g) := \lim_{\varrho \rightarrow \infty} \frac{\Gamma(\frac{n}{2})}{4(n-1)\pi^{n/2}} \int_{\Sigma(\varrho)} [g_{ij,i} - g_{ii,j}] \nu^j \alpha_E$$

where

- $\Sigma(\varrho) \approx S^{n-1}/\Gamma_i$ is given by $|\vec{x}| = \varrho$;
- ν is the outpointing Euclidean unit normal;
and
- α_E is the volume $(n-1)$ -form induced by the Euclidean metric.

Chruściel:

$$g_{jk} = \delta_{jk} + O(|x|^{1-\frac{n}{2}-\varepsilon})$$

$$g_{jk,\ell} = O(|x|^{-\frac{n}{2}-\varepsilon}), \quad s \in L^1$$

Positive Mass Conjecture:

Positive Mass Conjecture:

Any AE manifold

Positive Mass Conjecture:

Any AE manifold with $s \geq 0$

Positive Mass Conjecture:

Any AE manifold with $s \geq 0$ has $m \geq 0$.

Positive Mass Conjecture:

Any AE manifold with $s \geq 0$ has $m \geq 0$.

Physical intuition:

Positive Mass Conjecture:

Any AE manifold with $s \geq 0$ has $m \geq 0$.

Physical intuition:

Local matter density ≥ 0

Positive Mass Conjecture:

Any AE manifold with $s \geq 0$ has $m \geq 0$.

Physical intuition:

Local matter density $\geq 0 \implies$ total mass ≥ 0 .

Positive Mass Conjecture:

Any AE manifold with $s \geq 0$ has $m \geq 0$.

Positive Mass Conjecture:

Any AE manifold with $s \geq 0$ has $m \geq 0$.

Schoen-Yau 1979:

Positive Mass Conjecture:

Any AE manifold with $s \geq 0$ has $m \geq 0$.

Schoen-Yau 1979:

Proved in dimension $n \leq 7$.

Positive Mass Conjecture:

Any AE manifold with $s \geq 0$ has $m \geq 0$.

Schoen-Yau 1979:

Proved in dimension $n \leq 7$.

Witten 1981:

Positive Mass Conjecture:

Any AE manifold with $s \geq 0$ has $m \geq 0$.

Schoen-Yau 1979:

Proved in dimension $n \leq 7$.

Witten 1981:

Proved for spin manifolds

Positive Mass Conjecture:

Any AE manifold with $s \geq 0$ has $m \geq 0$.

Schoen-Yau 1979:

Proved in dimension $n \leq 7$.

Witten 1981:

Proved for spin manifolds (implicitly, for any n).

Positive Mass Conjecture:

Any AE manifold with $s \geq 0$ has $m \geq 0$.

Schoen-Yau 1979:

Proved in dimension $n \leq 7$.

Witten 1981:

Proved for spin manifolds (implicitly, for any n).

Schoen-Yau 2018:

Positive Mass Conjecture:

Any AE manifold with $s \geq 0$ has $m \geq 0$.

Schoen-Yau 1979:

Proved in dimension $n \leq 7$.

Witten 1981:

Proved for spin manifolds (implicitly, for any n).

Schoen-Yau 2018:

General case in arbitrary dimension n .

Positive Mass Conjecture:

Any AE manifold with $s \geq 0$ has $m \geq 0$.

Schoen-Yau 1979:

Proved in dimension $n \leq 7$.

Witten 1981:

Proved for spin manifolds (implicitly, for any n).

Positive Mass Conjecture:

Any AE manifold with $s \geq 0$ has $m \geq 0$.

Schoen-Yau 1979:

Proved in dimension $n \leq 7$.

Witten 1981:

Proved for spin manifolds (implicitly, for any n).

Hawking-Pope 1978:

Positive Mass Conjecture:

Any AE manifold with $s \geq 0$ has $m \geq 0$.

Schoen-Yau 1979:

Proved in dimension $n \leq 7$.

Witten 1981:

Proved for spin manifolds (implicitly, for any n).

Hawking-Pope 1978:

Conjectured true in ALE case, too.

Positive Mass Conjecture:

Any AE manifold with $s \geq 0$ has $m \geq 0$.

Schoen-Yau 1979:

Proved in dimension $n \leq 7$.

Witten 1981:

Proved for spin manifolds (implicitly, for any n).

Hawking-Pope 1978:

Conjectured true in ALE case, too.

L 1986:

Positive Mass Conjecture:

Any AE manifold with $s \geq 0$ has $m \geq 0$.

Schoen-Yau 1979:

Proved in dimension $n \leq 7$.

Witten 1981:

Proved for spin manifolds (implicitly, for any n).

Hawking-Pope 1978:

Conjectured true in ALE case, too.

L 1986:

ALE counter-examples.

Positive Mass Conjecture:

Any AE manifold with $s \geq 0$ has $m \geq 0$.

Schoen-Yau 1979:

Proved in dimension $n \leq 7$.

Witten 1981:

Proved for spin manifolds (implicitly, for any n).

Hawking-Pope 1978:

Conjectured true in ALE case, too.

L 1986:

ALE counter-examples.

Scalar-flat Kähler metrics

Positive Mass Conjecture:

Any AE manifold with $s \geq 0$ has $m \geq 0$.

Schoen-Yau 1979:

Proved in dimension $n \leq 7$.

Witten 1981:

Proved for spin manifolds (implicitly, for any n).

Hawking-Pope 1978:

Conjectured true in ALE case, too.

L 1986:

ALE counter-examples.

Scalar-flat Kähler metrics

on line bundles $L \rightarrow \mathbb{C}P_1$ of Chern-class ≤ -3 .

Mass of **ALE** Kähler manifolds?

Mass of **ALE Kähler** manifolds?

Lemma.

Mass of **ALE Kähler** manifolds?

Lemma. *Any ALE Kähler manifold*

Mass of **ALE Kähler** manifolds?

Lemma. *Any ALE Kähler manifold has only one end.*

Mass of **ALE Kähler** manifolds?

Lemma. *Any **ALE Kähler** manifold has only one end.*

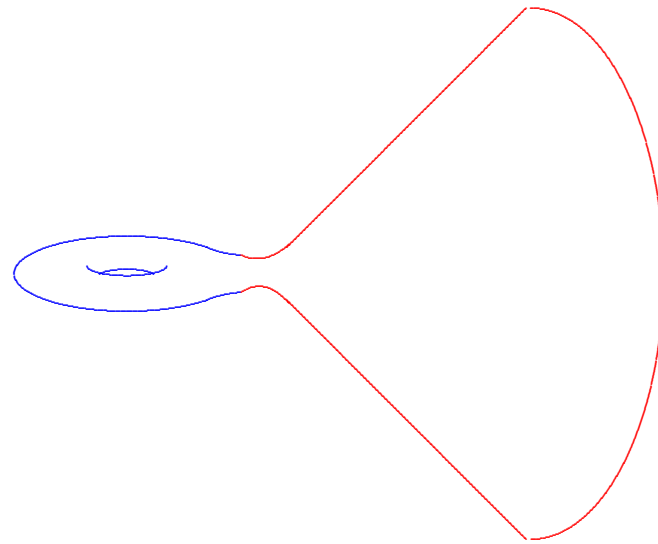

Mass of **ALE Kähler** manifolds?

Lemma. *Any ALE Kähler manifold has only one end.*

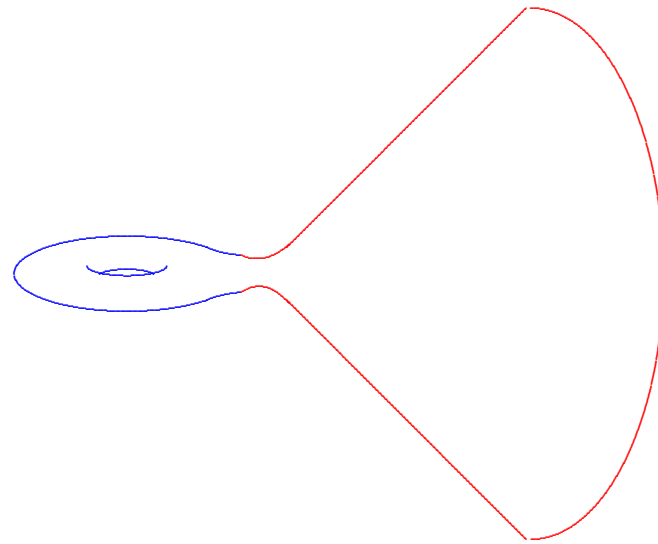

$$n = 2m \geq 4$$

Mass of **ALE Kähler** manifolds?

Lemma. *Any ALE Kähler manifold has only one end.*

Mass of **ALE Kähler** manifolds?

Lemma. *Any ALE Kähler manifold has only one end.*

Proof is particularly subtle in real dimension 4!

Mass of **ALE Kähler** manifolds?

Lemma. *Any ALE Kähler manifold has only one end.*

Proof is particularly subtle in real dimension 4!

Chruściel fall-off is weakest in this dimension.

Mass of **ALE Kähler** manifolds?

Lemma. *Any ALE Kähler manifold has only one end.*

Proof is particularly subtle in real dimension 4!

Proof uses methods of symplectic topology.

Mass of **ALE Kähler** manifolds?

Lemma. *Any ALE Kähler manifold has only one end.*

Mass of **ALE Kähler** manifolds?

Lemma. *Any ALE Kähler manifold has only one end.*

Upshot:

Mass of **ALE Kähler** manifolds?

Lemma. *Any ALE Kähler manifold has only one end.*

Upshot:

Mass of an **ALE Kähler** manifold is unambiguous.

Mass of **ALE Kähler** manifolds?

Lemma. *Any **ALE Kähler** manifold has only one end.*

Upshot:

Mass of an **ALE Kähler** manifold is unambiguous.

Does not depend on the choice of an end!

We begin with the scalar-flat Kähler case.

We begin with the scalar-flat Kähler case.

Theorem A.

We begin with the scalar-flat Kähler case.

Theorem A. *The mass*

We begin with the scalar-flat Kähler case.

Theorem A. *The mass of an ALE*

We begin with the scalar-flat Kähler case.

Theorem A. *The mass of an ALE scalar-flat Kähler manifold*

We begin with the scalar-flat Kähler case.

Theorem A. *The mass of an ALE scalar-flat Kähler manifold is a topological invariant.*

We begin with the scalar-flat Kähler case.

Theorem A. *The mass of an ALE scalar-flat Kähler manifold is a topological invariant.*

That is, $m(M, g, J)$

We begin with the scalar-flat Kähler case.

Theorem A. *The mass of an ALE scalar-flat Kähler manifold is a topological invariant.*

That is, $m(M, g, J)$ is completely determined by

We begin with the scalar-flat Kähler case.

Theorem A. *The mass of an ALE scalar-flat Kähler manifold is a topological invariant.*

That is, $m(M, g, J)$ is completely determined by

- *the smooth manifold M ,*

We begin with the scalar-flat Kähler case.

Theorem A. *The mass of an ALE scalar-flat Kähler manifold is a topological invariant.*

That is, $m(M, g, J)$ is completely determined by

- *the smooth manifold M ,*
- *the first Chern class $c_1 = c_1(M, J) \in H^2(M)$ of the complex structure, and*

We begin with the scalar-flat Kähler case.

Theorem A. *The mass of an ALE scalar-flat Kähler manifold is a topological invariant.*

That is, $m(M, g, J)$ is completely determined by

- *the smooth manifold M ,*
- *the first Chern class $c_1 = c_1(M, J) \in H^2(M)$ of the complex structure, and*
- *the Kähler class $[\omega] \in H^2(M)$ of the metric.*

We begin with the scalar-flat Kähler case.

Theorem A. *The mass of an ALE scalar-flat Kähler manifold is a topological invariant.*

That is, $m(M, g, J)$ is completely determined by

- *the smooth manifold M ,*
- *the first Chern class $c_1 = c_1(M, J) \in H^2(M)$ of the complex structure, and*
- *the Kähler class $[\omega] \in H^2(M)$ of the metric.*

In fact, we will see that there is an explicit formula for the mass in terms of these data!

The explicit formula reproduces the mass in cases where it previously had been laboriously computed from the definition.

The explicit formula reproduces the mass in cases where it previously had been laboriously computed from the definition. But it also allows one to quickly read it off quite generally.

The explicit formula reproduces the mass in cases where it previously had been laboriously computed from the definition. But it also allows one to quickly read it off quite generally.

Negative mass theorem in the ALE case:

The explicit formula reproduces the mass in cases where it previously had been laboriously computed from the definition. But it also allows one to quickly read it off quite generally.

Negative mass theorem in the ALE case:

Theorem B.

The explicit formula reproduces the mass in cases where it previously had been laboriously computed from the definition. But it also allows one to quickly read it off quite generally.

Negative mass theorem in the ALE case:

Theorem B. *Let (M^4, g, J) be an ALE scalar-flat Kähler surface,*

The explicit formula reproduces the mass in cases where it previously had been laboriously computed from the definition. But it also allows one to quickly read it off quite generally.

Negative mass theorem in the ALE case:

Theorem B. *Let (M^4, g, J) be an ALE scalar-flat Kähler surface, and suppose that (M, J) is the minimal resolution of a surface singularity.*

The explicit formula reproduces the mass in cases where it previously had been laboriously computed from the definition. But it also allows one to quickly read it off quite generally.

Negative mass theorem in the ALE case:

Theorem B. *Let (M^4, g, J) be an ALE scalar-flat Kähler surface, and suppose that (M, J) is the minimal resolution of a surface singularity.*

minimal: containing no (-1) -curves

The explicit formula reproduces the mass in cases where it previously had been laboriously computed from the definition. But it also allows one to quickly read it off quite generally.

Negative mass theorem in the ALE case:

Theorem B. *Let (M^4, g, J) be an ALE scalar-flat Kähler surface, and suppose that (M, J) is the minimal resolution of a surface singularity.*

minimal: not the blow-up of another resolution

The explicit formula reproduces the mass in cases where it previously had been laboriously computed from the definition. But it also allows one to quickly read it off quite generally.

Negative mass theorem in the ALE case:

Theorem B. *Let (M^4, g, J) be an ALE scalar-flat Kähler surface, and suppose that (M, J) is the minimal resolution of a surface singularity.*

The explicit formula reproduces the mass in cases where it previously had been laboriously computed from the definition. But it also allows one to quickly read it off quite generally.

Negative mass theorem in the ALE case:

Theorem B. *Let (M^4, g, J) be an ALE scalar-flat Kähler surface, and suppose that (M, J) is the minimal resolution of a surface singularity. Then $m(M, g) \leq 0$,*

The explicit formula reproduces the mass in cases where it previously had been laboriously computed from the definition. But it also allows one to quickly read it off quite generally.

Negative mass theorem in the ALE case:

Theorem B. *Let (M^4, g, J) be an ALE scalar-flat Kähler surface, and suppose that (M, J) is the minimal resolution of a surface singularity. Then $m(M, g) \leq 0$, with $=$ iff g is Ricci-flat.*

The explicit formula reproduces the mass in cases where it previously had been laboriously computed from the definition. But it also allows one to quickly read it off quite generally.

Negative mass theorem in the ALE case:

Theorem B. *Let (M^4, g, J) be an ALE scalar-flat Kähler surface, and suppose that (M, J) is the minimal resolution of a surface singularity. Then $m(M, g) \leq 0$, with $=$ iff g is Ricci-flat.*

Note that **minimality** is essential here.

The explicit formula reproduces the mass in cases where it previously had been laboriously computed from the definition. But it also allows one to quickly read it off quite generally.

Negative mass theorem in the ALE case:

Theorem B. *Let (M^4, g, J) be an ALE scalar-flat Kähler surface, and suppose that (M, J) is the minimal resolution of a surface singularity. Then $m(M, g) \leq 0$, with $=$ iff g is Ricci-flat.*

Note that **minimality** is essential here.

Non-minimal resolutions typically admit families of such metrics for which the mass can be continuously deformed from negative to positive.

Explicit formula depends on a topological fact:

Explicit formula depends on a topological fact:

Lemma.

Explicit formula depends on a topological fact:

Lemma. *Let (M, g) be any ALE manifold*

Explicit formula depends on a topological fact:

Lemma. *Let (M, g) be any ALE manifold of real dimension $n \geq 4$.*

Explicit formula depends on a topological fact:

Lemma. *Let (M, g) be any ALE manifold of real dimension $n \geq 4$. Then the natural map*

Explicit formula depends on a topological fact:

Lemma. *Let (M, g) be any ALE manifold of real dimension $n \geq 4$. Then the natural map*

$$H_c^2(M) \rightarrow H_{dR}^2(M)$$

Explicit formula depends on a topological fact:

Lemma. *Let (M, g) be any ALE manifold of real dimension $n \geq 4$. Then the natural map*

$$H_c^2(M) \rightarrow H_{dR}^2(M)$$

is an isomorphism.

Explicit formula depends on a topological fact:

Lemma. *Let (M, g) be any ALE manifold of real dimension $n \geq 4$. Then the natural map*

$$H_c^2(M) \rightarrow H_{dR}^2(M)$$

is an isomorphism.

Here

$$H_c^p(M) := \frac{\ker d : \mathcal{E}_c^p(M) \rightarrow \mathcal{E}_c^{p+1}(M)}{d\mathcal{E}_c^{p-1}(M)}$$

Explicit formula depends on a topological fact:

Lemma. *Let (M, g) be any ALE manifold of real dimension $n \geq 4$. Then the natural map*

$$H_c^2(M) \rightarrow H_{dR}^2(M)$$

is an isomorphism.

Here

$$H_c^p(M) := \frac{\ker d : \mathcal{E}_c^p(M) \rightarrow \mathcal{E}_c^{p+1}(M)}{d\mathcal{E}_c^{p-1}(M)}$$

where

$$\mathcal{E}_c^p(M) := \{\text{Smooth, compactly supported } p\text{-forms on } M\}.$$

Explicit formula depends on a topological fact:

Lemma. *Let (M, g) be any ALE manifold of real dimension $n \geq 4$. Then the natural map*

$$H_c^2(M) \rightarrow H_{dR}^2(M)$$

is an isomorphism.

Explicit formula depends on a topological fact:

Lemma. *Let (M, g) be any ALE manifold of real dimension $n \geq 4$. Then the natural map*

$$H_c^2(M) \rightarrow H_{dR}^2(M)$$

is an isomorphism.

Definition.

Explicit formula depends on a topological fact:

Lemma. *Let (M, g) be any ALE manifold of real dimension $n \geq 4$. Then the natural map*

$$H_c^2(M) \rightarrow H_{dR}^2(M)$$

is an isomorphism.

Definition. *If (M, g, J) is any ALE Kähler manifold,*

Explicit formula depends on a topological fact:

Lemma. *Let (M, g) be any ALE manifold of real dimension $n \geq 4$. Then the natural map*

$$H_c^2(M) \rightarrow H_{dR}^2(M)$$

is an isomorphism.

Definition. *If (M, g, J) is any ALE Kähler manifold, we will use*

Explicit formula depends on a topological fact:

Lemma. *Let (M, g) be any ALE manifold of real dimension $n \geq 4$. Then the natural map*

$$H_c^2(M) \rightarrow H_{dR}^2(M)$$

is an isomorphism.

Definition. *If (M, g, J) is any ALE Kähler manifold, we will use*

$$\clubsuit : H_{dR}^2(M) \rightarrow H_c^2(M)$$

Explicit formula depends on a topological fact:

Lemma. *Let (M, g) be any ALE manifold of real dimension $n \geq 4$. Then the natural map*

$$H_c^2(M) \rightarrow H_{dR}^2(M)$$

is an isomorphism.

Definition. *If (M, g, J) is any ALE Kähler manifold, we will use*

$$\clubsuit : H_{dR}^2(M) \rightarrow H_c^2(M)$$

to denote the inverse of the natural map

Explicit formula depends on a topological fact:

Lemma. *Let (M, g) be any ALE manifold of real dimension $n \geq 4$. Then the natural map*

$$H_c^2(M) \rightarrow H_{dR}^2(M)$$

is an isomorphism.

Definition. *If (M, g, J) is any ALE Kähler manifold, we will use*

$$\clubsuit : H_{dR}^2(M) \rightarrow H_c^2(M)$$

to denote the inverse of the natural map

$$H_c^2(M) \rightarrow H_{dR}^2(M)$$

Explicit formula depends on a topological fact:

Lemma. *Let (M, g) be any ALE manifold of real dimension $n \geq 4$. Then the natural map*

$$H_c^2(M) \rightarrow H_{dR}^2(M)$$

is an isomorphism.

Definition. *If (M, g, J) is any ALE Kähler manifold, we will use*

$$\clubsuit : H_{dR}^2(M) \rightarrow H_c^2(M)$$

to denote the inverse of the natural map

$$H_c^2(M) \rightarrow H_{dR}^2(M)$$

induced by the inclusion of compactly supported smooth forms into all forms.

We can now state our mass formula:

Theorem C.

We can now state our mass formula:

Theorem C. *Any ALE Kähler manifold (M, g, J)*

We can now state our mass formula:

Theorem C. *Any ALE Kähler manifold (M, g, J) of complex dimension m*

We can now state our mass formula:

Theorem C. *Any ALE Kähler manifold (M, g, J) of complex dimension m has mass given by*

We can now state our mass formula:

Theorem C. *Any ALE Kähler manifold (M, g, J) of complex dimension m has mass given by*

$$m(M, g) = \quad +$$

We can now state our mass formula:

Theorem C. *Any ALE Kähler manifold (M, g, J) of complex dimension m has mass given by*

$$m(M, g) = \quad + \quad \int_M s_g d\mu_g$$

We can now state our mass formula:

Theorem C. Any *ALE Kähler manifold* (M, g, J) of complex dimension m has mass given by

$$m(M, g) = + \frac{(m-1)!}{4(2m-1)\pi^m} \int_M s_g d\mu_g$$

We can now state our mass formula:

Theorem C. Any *ALE Kähler manifold* (M, g, J) of complex dimension m has mass given by

$$m(M, g) = - \langle \clubsuit(c_1), [\omega]^{m-1} \rangle + \frac{(m-1)!}{4(2m-1)\pi^m} \int_M s_g d\mu_g$$

We can now state our mass formula:

Theorem C. Any *ALE Kähler manifold* (M, g, J) of complex dimension m has mass given by

$$m(M, g) = -\frac{\langle \clubsuit(c_1), [\omega]^{m-1} \rangle}{(2m-1)\pi^{m-1}} + \frac{(m-1)!}{4(2m-1)\pi^m} \int_M s_g d\mu_g$$

We can now state our mass formula:

Theorem C. Any *ALE Kähler manifold* (M, g, J) of complex dimension m has mass given by

$$m(M, g) = -\frac{\langle \clubsuit(c_1), [\omega]^{m-1} \rangle}{(2m-1)\pi^{m-1}} + \frac{(m-1)!}{4(2m-1)\pi^m} \int_M s_g d\mu_g$$

where

We can now state our mass formula:

Theorem C. Any *ALE Kähler manifold* (M, g, J) of complex dimension m has mass given by

$$m(M, g) = -\frac{\langle \clubsuit(c_1), [\omega]^{m-1} \rangle}{(2m-1)\pi^{m-1}} + \frac{(m-1)!}{4(2m-1)\pi^m} \int_M s_g d\mu_g$$

where

- s = scalar curvature;

We can now state our mass formula:

Theorem C. Any *ALE Kähler manifold* (M, g, J) of complex dimension m has mass given by

$$m(M, g) = -\frac{\langle \clubsuit(c_1), [\omega]^{m-1} \rangle}{(2m-1)\pi^{m-1}} + \frac{(m-1)!}{4(2m-1)\pi^m} \int_M s_g d\mu_g$$

where

- s = scalar curvature;
- $d\mu$ = metric volume form;

We can now state our mass formula:

Theorem C. Any *ALE Kähler manifold* (M, g, J) of complex dimension m has mass given by

$$m(M, g) = -\frac{\langle \clubsuit(c_1), [\omega]^{m-1} \rangle}{(2m-1)\pi^{m-1}} + \frac{(m-1)!}{4(2m-1)\pi^m} \int_M s_g d\mu_g$$

where

- s = scalar curvature;
- $d\mu$ = metric volume form;
- $c_1 = c_1(M, J) \in H^2(M)$ is first Chern class;

We can now state our mass formula:

Theorem C. Any ALE Kähler manifold (M, g, J) of complex dimension m has mass given by

$$m(M, g) = -\frac{\langle \clubsuit(c_1), [\omega]^{m-1} \rangle}{(2m-1)\pi^{m-1}} + \frac{(m-1)!}{4(2m-1)\pi^m} \int_M s_g d\mu_g$$

where

- s = scalar curvature;
- $d\mu$ = metric volume form;
- $c_1 = c_1(M, J) \in H^2(M)$ is first Chern class;
- $[\omega] \in H^2(M)$ is Kähler class of (g, J) ; and

We can now state our mass formula:

Theorem C. Any *ALE Kähler manifold* (M, g, J) of complex dimension m has mass given by

$$m(M, g) = -\frac{\langle \clubsuit(c_1), [\omega]^{m-1} \rangle}{(2m-1)\pi^{m-1}} + \frac{(m-1)!}{4(2m-1)\pi^m} \int_M s_g d\mu_g$$

where

- s = scalar curvature;
- $d\mu$ = metric volume form;
- $c_1 = c_1(M, J) \in H^2(M)$ is first Chern class;
- $[\omega] \in H^2(M)$ is Kähler class of (g, J) ; and
- $\langle \cdot, \cdot \rangle$ is pairing between $H_c^2(M)$ and $H^{2m-2}(M)$.

$$m(M, g) = -\frac{\langle \clubsuit(c_1), [\omega]^{m-1} \rangle}{(2m-1)\pi^{m-1}} + \frac{(m-1)!}{4(2m-1)\pi^m} \int_M s_g d\mu_g$$

$$\frac{4\pi^m(2m-1)}{(m-1)!} \mathfrak{m}(M, g) = -\frac{4\pi}{(m-1)!} \langle \clubsuit(c_1), [\omega]^{m-1} \rangle + \int_M s_g d\mu_g$$

For a compact Kähler manifold (M^{2m}, g, J) ,

$$\int_M s_g d\mu_g = \frac{4\pi}{(m-1)!} \langle c_1, [\omega]^{m-1} \rangle$$

For a compact Kähler manifold (M^{2m}, g, J) ,

$$0 = -\frac{4\pi}{(m-1)!} \langle c_1, [\omega]^{m-1} \rangle + \int_M s_g d\mu_g$$

For an ALE Kähler manifold (M^{2m}, g, J) ,

$$m(M, g) = -\frac{\langle \clubsuit(c_1), [\omega]^{m-1} \rangle}{(2m-1)\pi^{m-1}} + \frac{(m-1)!}{4(2m-1)\pi^m} \int_M s_g d\mu_g$$

For an ALE Kähler manifold (M^{2m}, g, J) ,

$$\frac{4\pi^m(2m-1)}{(m-1)!} m(M, g) = -\frac{4\pi}{(m-1)!} \langle \clubsuit(c_1), [\omega]^{m-1} \rangle + \int_M s_g d\mu_g$$

So the mass is a “boundary correction” to the topological formula for the total scalar curvature.

Theorem C. Any *ALE Kähler manifold* (M, g, J) of complex dimension m has mass given by

$$m(M, g) = -\frac{\langle \clubsuit(c_1), [\omega]^{m-1} \rangle}{(2m-1)\pi^{m-1}} + \frac{(m-1)!}{4(2m-1)\pi^m} \int_M s_g d\mu_g$$

Corollary. Any ALE scalar-flat Kähler manifold (M, g, J) of complex dimension m has mass given by

$$m(M, g) = -\frac{\langle \clubsuit(c_1), [\omega]^{m-1} \rangle}{(2m-1)\pi^{m-1}}.$$

Corollary. Any ALE scalar-flat Kähler manifold (M, g, J) of complex dimension m has mass given by

$$m(M, g) = -\frac{\langle \clubsuit(c_1), [\omega]^{m-1} \rangle}{(2m-1)\pi^{m-1}}.$$

So **Theorem A** is an immediate consequence!

Corollary. Any ALE scalar-flat Kähler manifold (M, g, J) of complex dimension m has mass given by

$$m(M, g) = -\frac{\langle \clubsuit(c_1), [\omega]^{m-1} \rangle}{(2m-1)\pi^{m-1}}.$$

Corollary. Any ALE scalar-flat Kähler manifold (M, g, J) of complex dimension m has mass given by

$$m(M, g) = -\frac{\langle \clubsuit(c_1), [\omega]^{m-1} \rangle}{(2m-1)\pi^{m-1}}.$$

Example. Blow up Chern class $-\ell$ line bundle over $\mathbb{C}P_1$ at k points on zero section Σ .

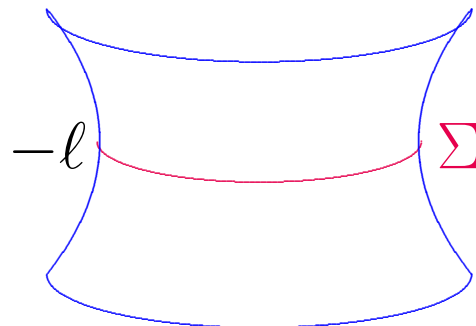

Corollary. Any ALE scalar-flat Kähler manifold (M, g, J) of complex dimension m has mass given by

$$m(M, g) = -\frac{\langle \clubsuit(c_1), [\omega]^{m-1} \rangle}{(2m-1)\pi^{m-1}}.$$

Example. Blow up Chern class $-\ell$ line bundle over $\mathbb{C}P_1$ at k points on zero section Σ .

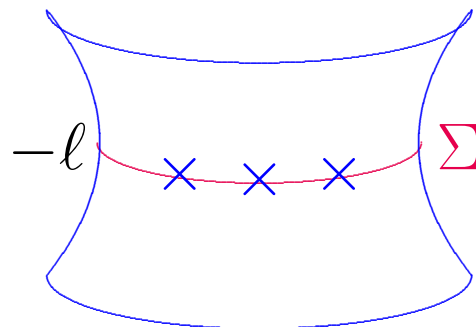

Corollary. Any ALE scalar-flat Kähler manifold (M, g, J) of complex dimension m has mass given by

$$m(M, g) = -\frac{\langle \clubsuit(c_1), [\omega]^{m-1} \rangle}{(2m-1)\pi^{m-1}}.$$

Example. Blow up Chern class $-\ell$ line bundle over $\mathbb{C}P_1$ at k points on zero section Σ .

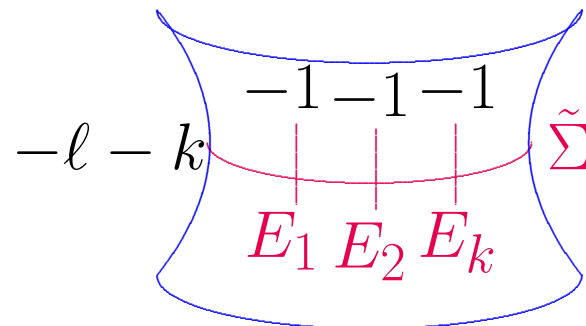

Corollary. Any ALE scalar-flat Kähler manifold (M, g, J) of complex dimension m has mass given by

$$m(M, g) = -\frac{\langle \clubsuit(c_1), [\omega]^{m-1} \rangle}{(2m-1)\pi^{m-1}}.$$

Example. Blow up Chern class $-\ell$ line bundle over $\mathbb{C}P_1$ at k points on zero section Σ .

$$m(M, g) = \frac{1}{3\pi\ell} \left[(2-\ell) \int_{\tilde{\Sigma}} \omega \right].$$

Corollary. Any ALE scalar-flat Kähler manifold (M, g, J) of complex dimension m has mass given by

$$m(M, g) = -\frac{\langle \clubsuit(c_1), [\omega]^{m-1} \rangle}{(2m-1)\pi^{m-1}}.$$

Example. Blow up Chern class $-\ell$ line bundle over $\mathbb{C}P_1$ at k points on zero section Σ .

$$m(M, g) = \frac{1}{3\pi\ell} \left[(2-\ell) \int_{\tilde{\Sigma}} \omega + 2 \sum_{j=1}^k \int_{E_j} \omega \right].$$

Corollary. Any ALE scalar-flat Kähler manifold (M, g, J) of complex dimension m has mass given by

$$m(M, g) = -\frac{\langle \clubsuit(c_1), [\omega]^{m-1} \rangle}{(2m-1)\pi^{m-1}}.$$

Theorem D (Positive Mass Theorem).

Theorem D (Positive Mass Theorem). *Any AE
Kähler manifold with*

Theorem D (Positive Mass Theorem). *Any AE Kähler manifold with non-negative scalar curvature*

Theorem D (Positive Mass Theorem). *Any AE Kähler manifold with non-negative scalar curvature has non-negative mass:*

Theorem D (Positive Mass Theorem). *Any AE Kähler manifold with non-negative scalar curvature has non-negative mass:*

$$AE \ \& \ \text{Kähler} \ \& \ s \geq 0 \quad \implies \quad m(M, g) \geq 0.$$

Theorem D (Positive Mass Theorem). *Any AE Kähler manifold with non-negative scalar curvature has non-negative mass:*

$$AE \ \& \ \text{Kähler} \ \& \ s \geq 0 \quad \implies \quad m(M, g) \geq 0.$$

Moreover, $m = 0 \iff$

Theorem D (Positive Mass Theorem). *Any AE Kähler manifold with non-negative scalar curvature has non-negative mass:*

$$AE \ \& \ \text{Kähler} \ \& \ s \geq 0 \implies m(M, g) \geq 0.$$

Moreover, $m = 0 \iff (M, g)$ is Euclidean space.

Theorem D (Positive Mass Theorem). *Any AE Kähler manifold with non-negative scalar curvature has non-negative mass:*

$$AE \ \& \ \text{Kähler} \ \& \ s \geq 0 \implies m(M, g) \geq 0.$$

Moreover, $m = 0 \iff (M, g)$ is Euclidean space.

Proof actually shows something stronger!

Theorem E (Penrose Inequality).

Theorem E (Penrose Inequality). *Let (M^{2m}, g, J) be an AE Kähler manifold*

Theorem E (Penrose Inequality). *Let (M^{2m}, g, J) be an AE Kähler manifold with scalar curvature $s \geq 0$.*

Theorem E (Penrose Inequality). *Let (M^{2m}, g, J) be an AE Kähler manifold with scalar curvature $s \geq 0$. Then (M, J) carries a canonical divisor D*

Theorem E (Penrose Inequality). *Let (M^{2m}, g, J) be an **AE** Kähler manifold with scalar curvature $s \geq 0$. Then (M, J) carries a **canonical** divisor D*

numerically **canonical** \iff Poincaré dual to $-c_1$.

Theorem E (Penrose Inequality). *Let (M^{2m}, g, J) be an AE Kähler manifold with scalar curvature $s \geq 0$. Then (M, J) carries a canonical divisor D*

Theorem E (Penrose Inequality). *Let (M^{2m}, g, J) be an AE Kähler manifold with scalar curvature $s \geq 0$. Then (M, J) carries a canonical divisor D that is expressed as a sum $\sum_j \mathbf{n}_j D_j$ of compact complex hypersurfaces with positive integer coefficients,*

Theorem E (Penrose Inequality). *Let (M^{2m}, g, J) be an **AE** Kähler manifold with scalar curvature $s \geq 0$. Then (M, J) carries a canonical divisor D that is expressed as a sum $\sum_j \mathbf{n}_j D_j$ of compact complex hypersurfaces with positive integer coefficients, with the property that $\bigcup_j D_j \neq \emptyset$*

Theorem E (Penrose Inequality). *Let (M^{2m}, g, J) be an **AE** Kähler manifold with scalar curvature $s \geq 0$. Then (M, J) carries a canonical divisor D that is expressed as a sum $\sum_j \mathbf{n}_j D_j$ of compact complex hypersurfaces with positive integer coefficients, with the property that $\bigcup_j D_j \neq \emptyset$ whenever $M \not\cong \mathbb{R}^{2m}$.*

Theorem E (Penrose Inequality). *Let (M^{2m}, g, J) be an AE Kähler manifold with scalar curvature $s \geq 0$. Then (M, J) carries a canonical divisor D that is expressed as a sum $\sum_j \mathbf{n}_j D_j$ of compact complex hypersurfaces with positive integer coefficients, with the property that $\bigcup_j D_j \neq \emptyset$ whenever $M \not\cong \mathbb{R}^{2m}$. In terms of this divisor, we then have*

Theorem E (Penrose Inequality). *Let (M^{2m}, g, J) be an **AE** Kähler manifold with scalar curvature $s \geq 0$. Then (M, J) carries a canonical divisor D that is expressed as a sum $\sum_j \mathbf{n}_j D_j$ of compact complex hypersurfaces with positive integer coefficients, with the property that $\bigcup_j D_j \neq \emptyset$ whenever $M \not\cong \mathbb{R}^{2m}$. In terms of this divisor, we then have*

$$m(M, g) \geq \sum \text{Vol}(D_j)$$

Theorem E (Penrose Inequality). *Let (M^{2m}, g, J) be an **AE** Kähler manifold with scalar curvature $s \geq 0$. Then (M, J) carries a canonical divisor D that is expressed as a sum $\sum_j \mathbf{n}_j D_j$ of compact complex hypersurfaces with positive integer coefficients, with the property that $\bigcup_j D_j \neq \emptyset$ whenever $M \not\cong \mathbb{R}^{2m}$. In terms of this divisor, we then have*

$$m(M, g) \geq \frac{(m-1)!}{(2m-1)\pi^{m-1}} \sum \mathbf{n}_j \text{Vol}(D_j)$$

Theorem E (Penrose Inequality). *Let (M^{2m}, g, J) be an **AE** Kähler manifold with scalar curvature $s \geq 0$. Then (M, J) carries a canonical divisor D that is expressed as a sum $\sum_j \mathbf{n}_j D_j$ of compact complex hypersurfaces with positive integer coefficients, with the property that $\bigcup_j D_j \neq \emptyset$ whenever $M \not\cong \mathbb{R}^{2m}$. In terms of this divisor, we then have*

$$m(M, g) \geq \frac{(m-1)!}{(2m-1)\pi^{m-1}} \sum \mathbf{n}_j \text{Vol}(D_j)$$

with $= \iff (M, g, J)$ is scalar-flat Kähler.

$$m(M, g) = -\frac{\langle \clubsuit(c_1), [\omega]^{m-1} \rangle}{(2m-1)\pi^{m-1}} + \frac{(m-1)!}{4(2m-1)\pi^m} \int_M s_g d\mu_g$$

$$m(M, g) = -\frac{\langle \clubsuit(c_1), [\omega]^{m-1} \rangle}{(2m-1)\pi^{m-1}} + \frac{(m-1)!}{4(2m-1)\pi^m} \int_M s_g d\mu_g$$

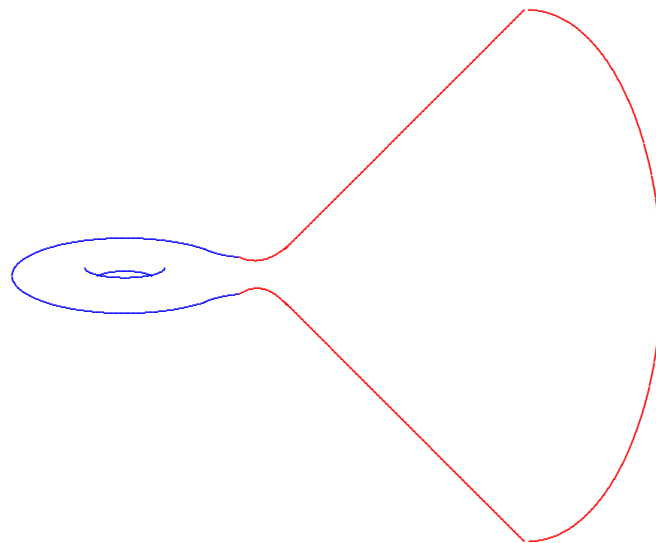

$$m(M, g) = -\frac{\langle \clubsuit(c_1), [\omega]^{m-1} \rangle}{(2m-1)\pi^{m-1}} + \frac{(m-1)!}{4(2m-1)\pi^m} \int_M s_g d\mu_g$$

$$m(M, g) = -\frac{\langle \clubsuit(c_1), [\omega]^{m-1} \rangle}{(2m-1)\pi^{m-1}} + \frac{(m-1)!}{4(2m-1)\pi^m} \int_M s_g d\mu_g$$

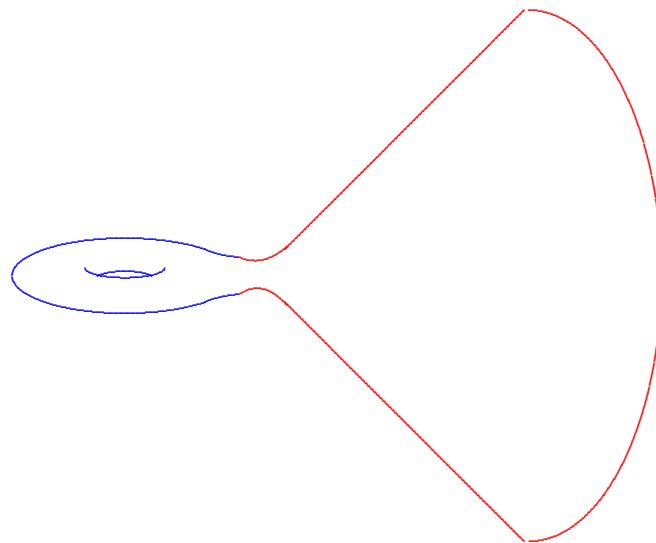

In fine,

Infine, vorrei ringraziare gli
organizzatori,

Infine, vorrei ringraziare gli
organizzatori, ed il dipartimento di
Matematica e Fisica,

Infine, vorrei ringraziare gli
organizzatori, ed il dipartimento di
Matematica e Fisica, per avermi invitato!

