

# CONFORMAL MAPS AND OPTIMAL MESHES

Christopher J. Bishop  
Stony Brook University

Georgia Tech, Feb. 18, 2015

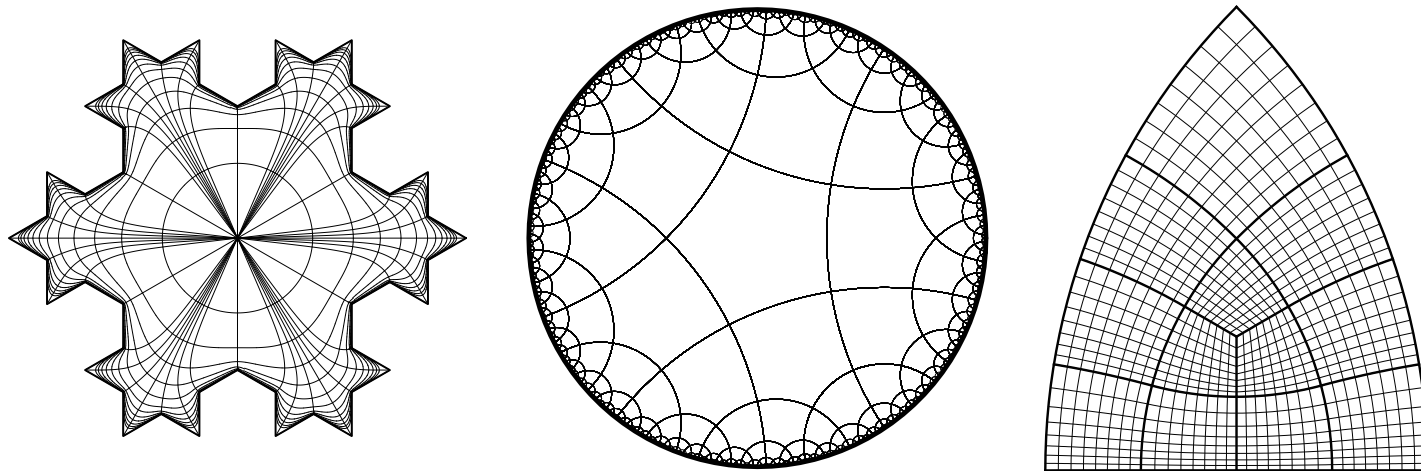

[www.math.sunysb.edu/~bishop/lectures](http://www.math.sunysb.edu/~bishop/lectures)

**Riemann Mapping Theorem:** If  $\Omega \subsetneq \mathbb{R}^2$  is simply connected, then there is a conformal map  $f : \mathbb{D} \rightarrow \Omega$ .

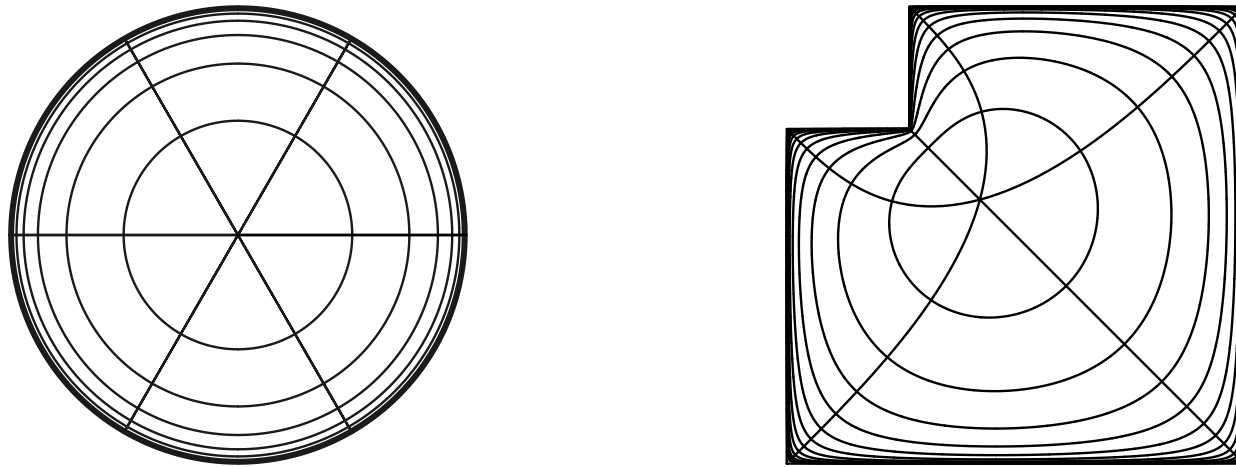

Conformal = angle preserving

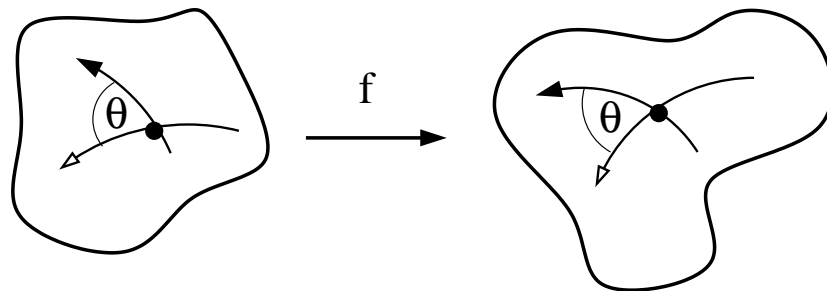



Georg Friedrich Bernhard Riemann  
Stated RMT in 1851



William Fogg Osgood  
First proof of RMT  
Transactions of AMS, vol. 1, 1900

*The proof of Osgood represented, in my opinion, the “coming of age” of mathematics in America. Until then, . . . the mathematical productivity in this country in quality lagged behind that of Europe, and no American before 1900 had reached the heights that Osgood then reached.*

J.L. Walsh, “History of the Riemann mapping theorem”,  
Amer. Math. Monthly, 1973.

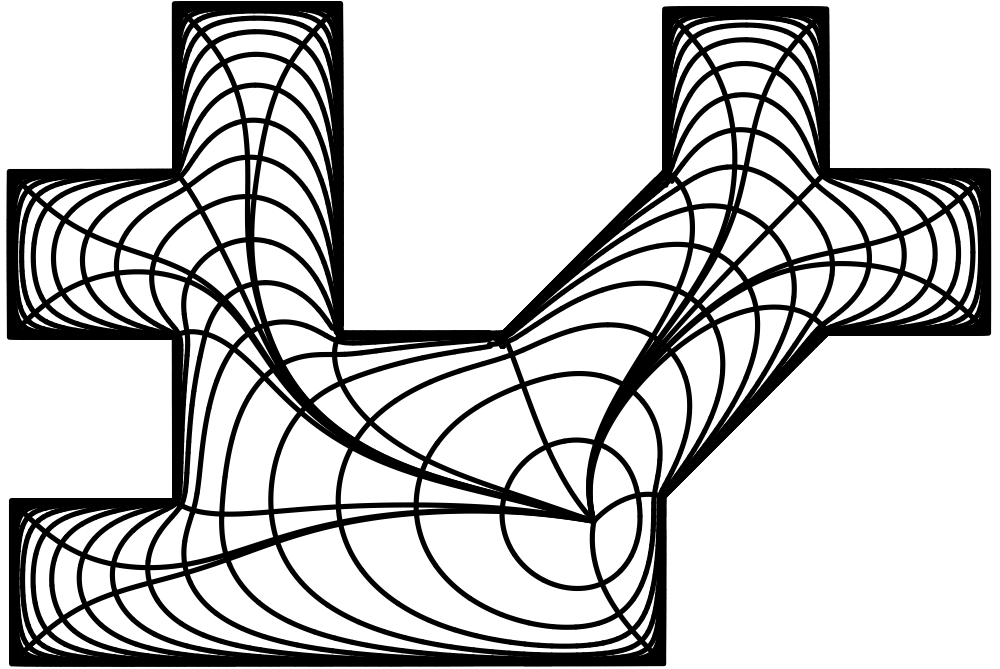
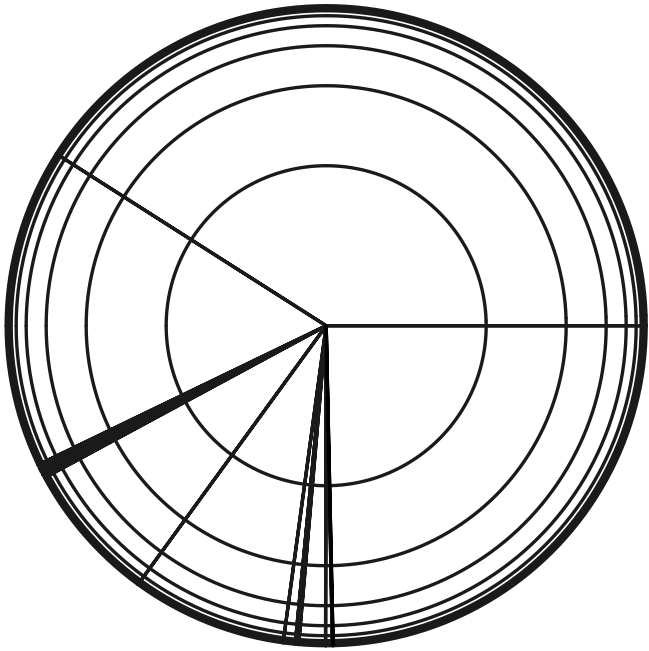

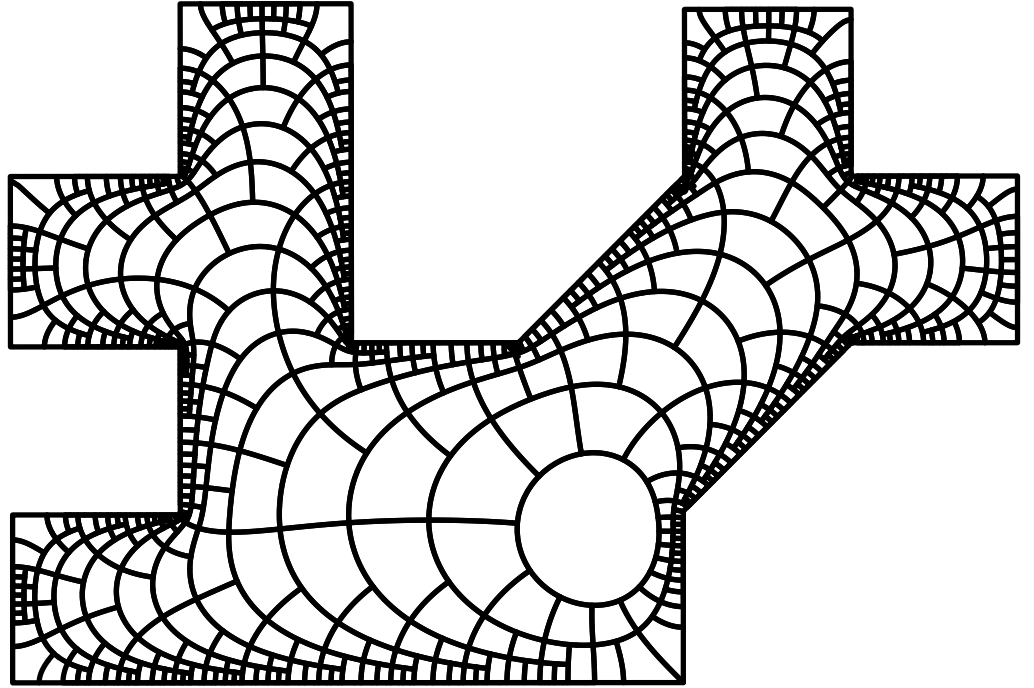
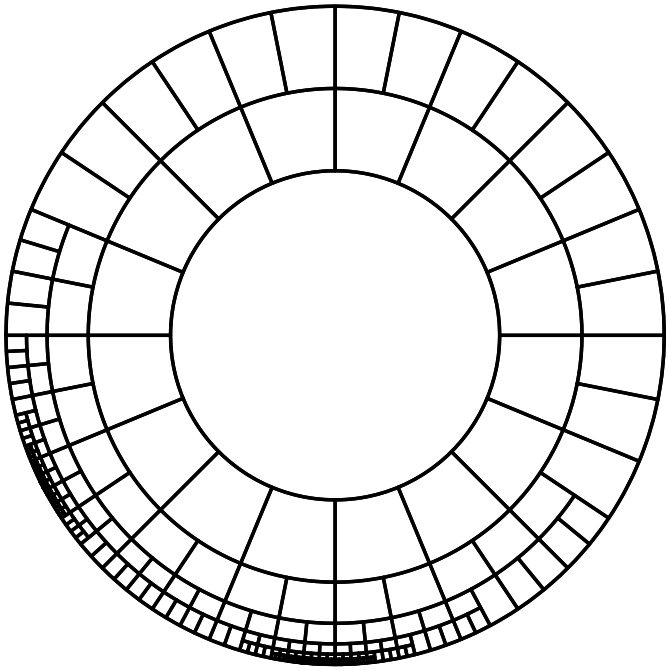

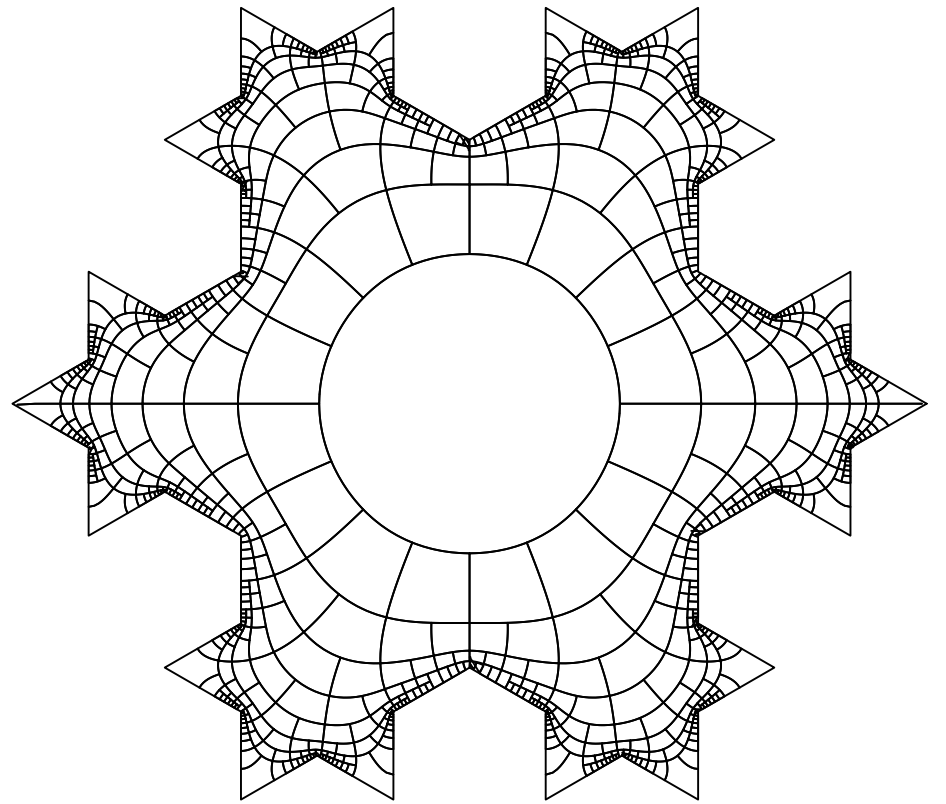
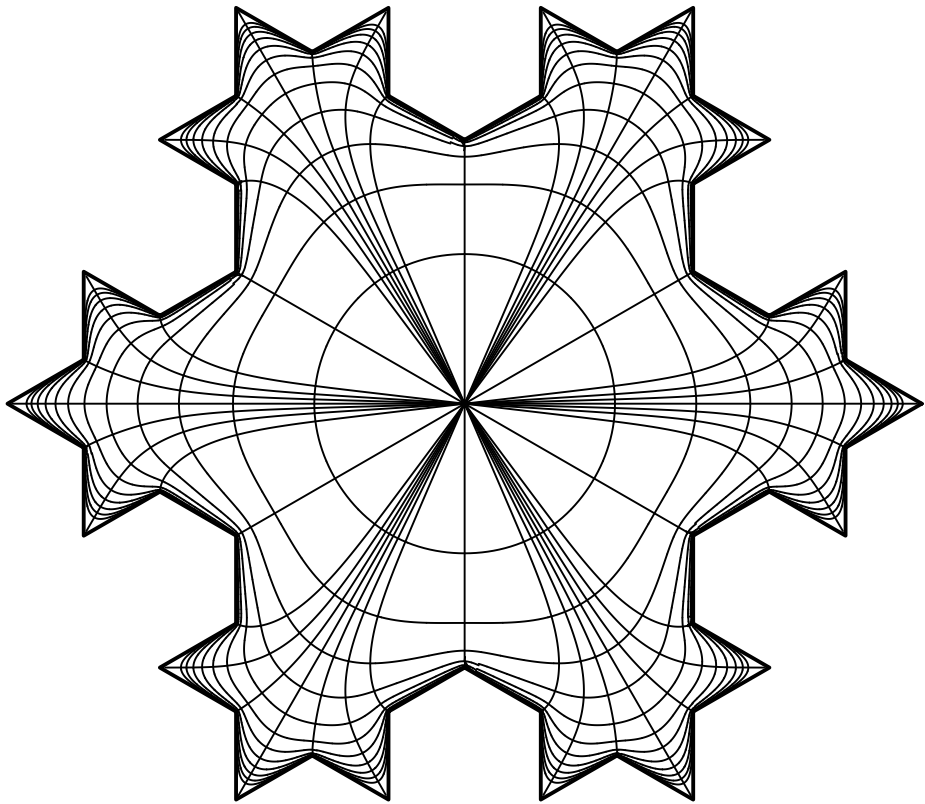



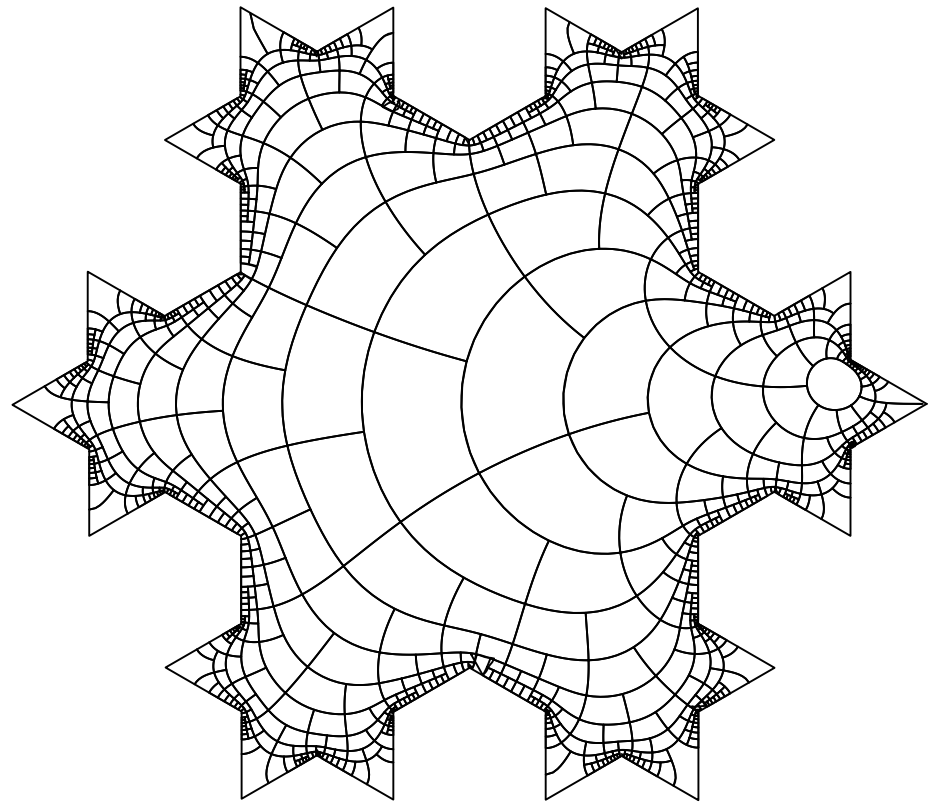
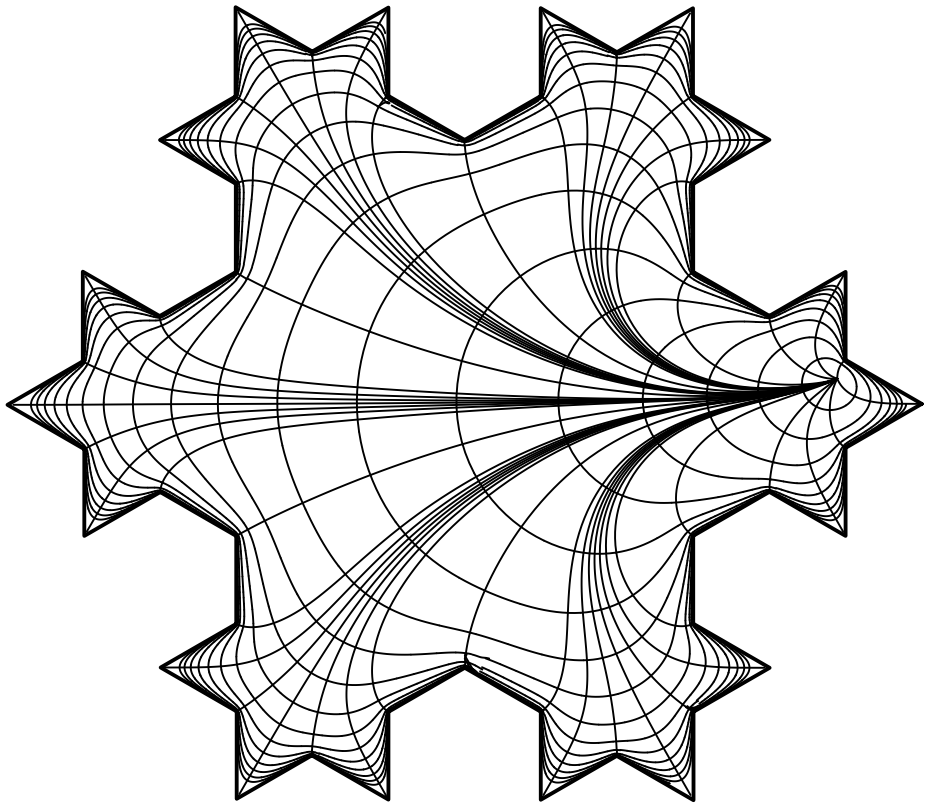

## Schwarz-Christoffel formula (1867):

$$f(z) = A + C \int^z \prod_{k=1}^n \left(1 - \frac{w}{z_k}\right)^{\alpha_k - 1} dw,$$

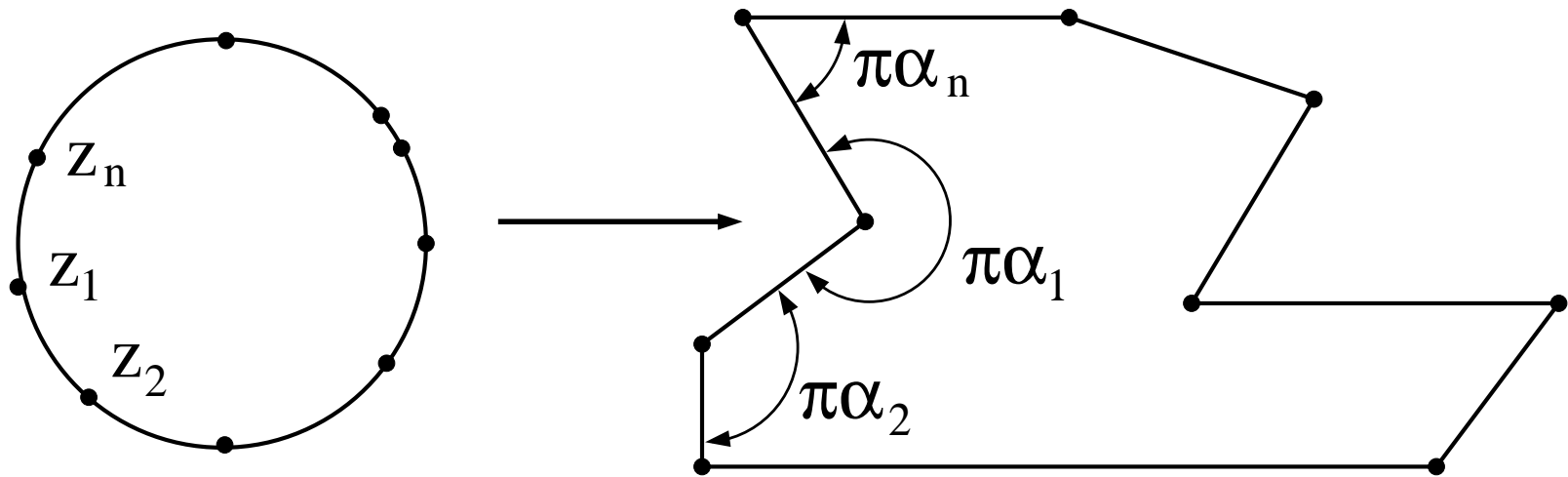

$\alpha$ 's known

$z$ 's unknown (= **SC-parameters** = pre-vertices)

## Schwarz-Christoffel formula (1867):

$$f(z) = A + C \int^z \prod_{k=1}^n \left(1 - \frac{w}{z_k}\right)^{\alpha_k - 1} dw,$$



Christoffel



Schwarz

**Fact:** Conformal map to a polygon is determined by the points on circle that map to the vertices.

**Problem:** given  $n$ -gon, compute these  $n$  points.

How fast can we do this?

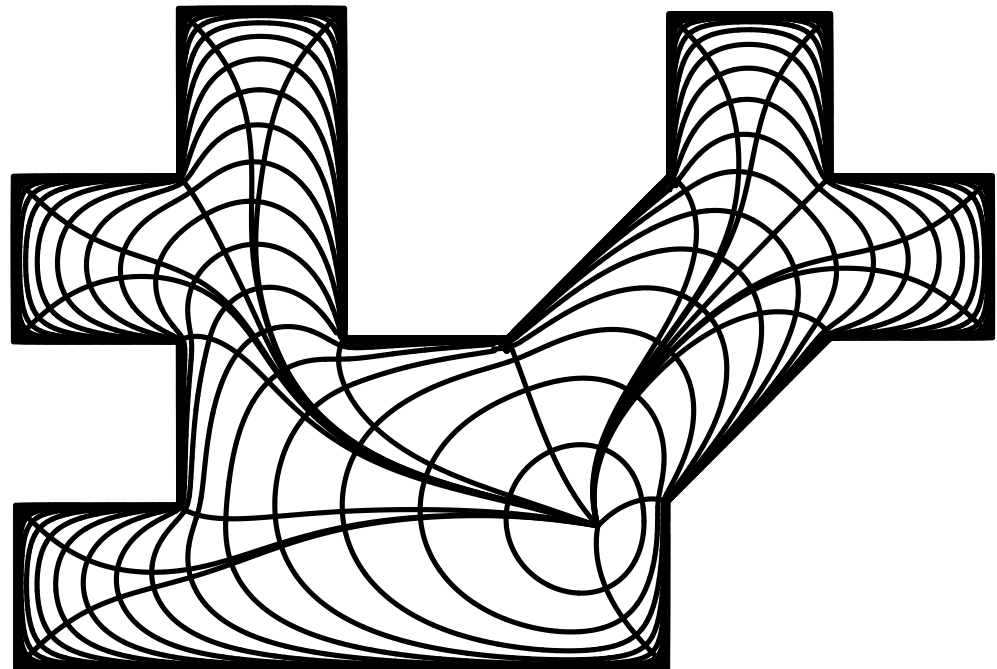
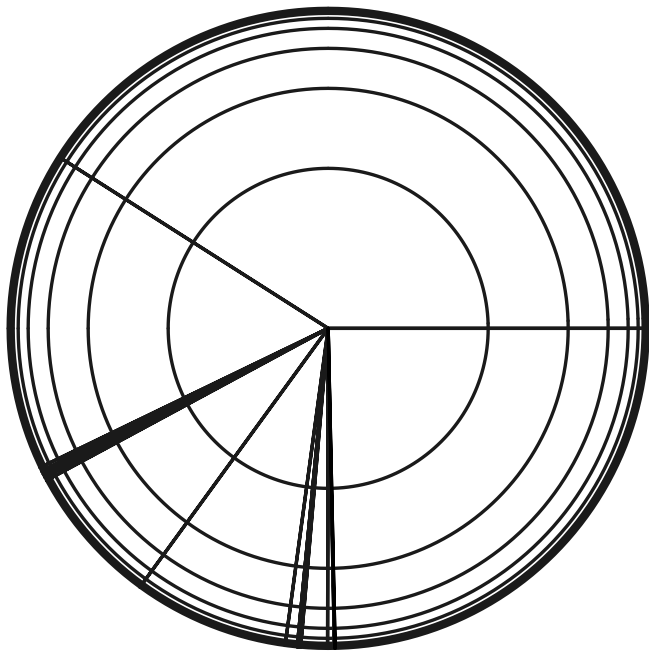

**Theorem:** Can compute SC-parameters in time  $C_\epsilon \cdot n$ .

**Theorem:** Can compute SC-parameters in time  $C_\epsilon \cdot n$ .

$\epsilon$  = error in quasiconformal sense.

$$C_\epsilon = O\left(\log \frac{1}{\epsilon} \log \log \frac{1}{\epsilon}\right).$$

**Quasiconformal maps:** bounded angle distortion

Roughly, a  $K$ -QC map multiplies angles by  $\leq K$ .

More precisely: tangent map sends circles to ellipses a.e.

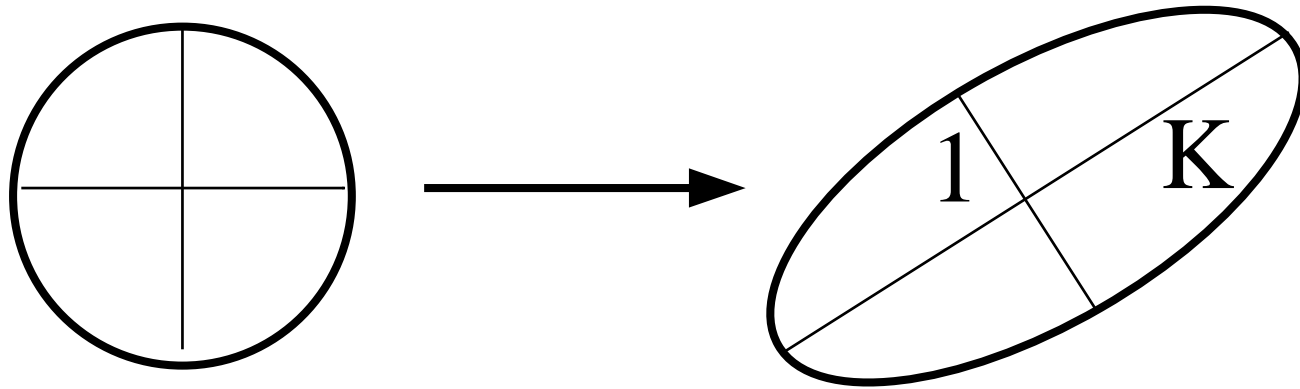

1-QC = conformal

$d_{QC}(z, w) = \inf \log K$  s.t.  $\exists K$ -QC map  $h(z) = w$ .

QC approximation implies Euclidean approximation.

## Measurable Riemann Mapping Theorem:

Given QC map  $g : \mathbb{D} \rightarrow \Omega$ , there is a QC  $f : \mathbb{D} \rightarrow \mathbb{D}$  so that  $g \circ f$  is conformal.

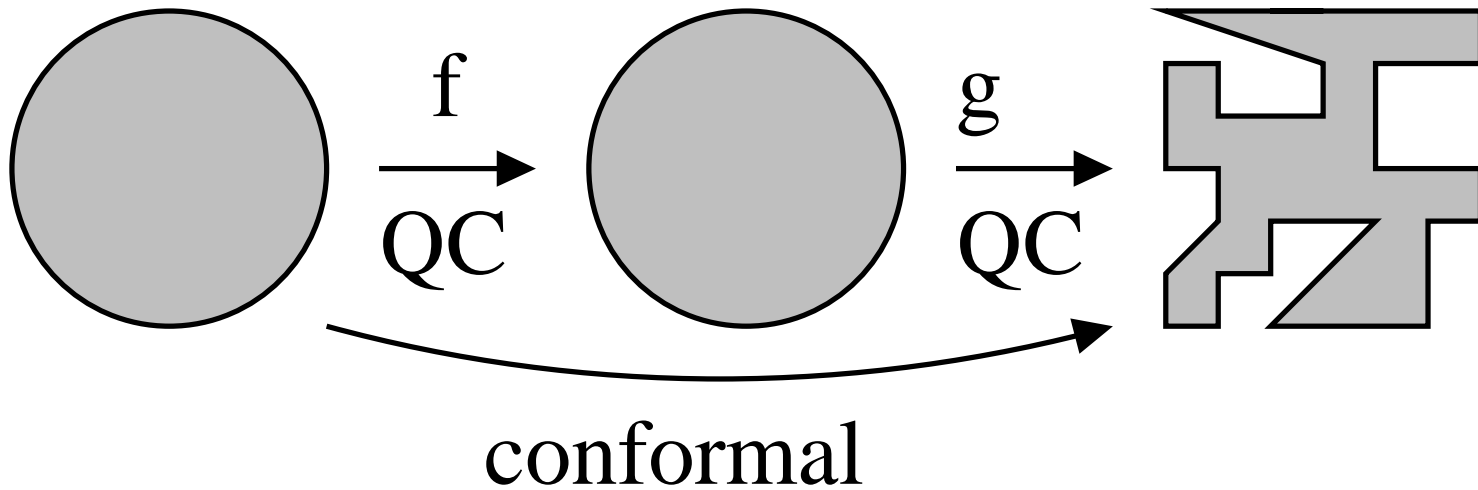



## Measurable Riemann Mapping Theorem:

Given QC map  $g : \mathbb{D} \rightarrow \Omega$ , there is a QC  $f : \mathbb{D} \rightarrow \mathbb{D}$  so that  $g \circ f$  is conformal.

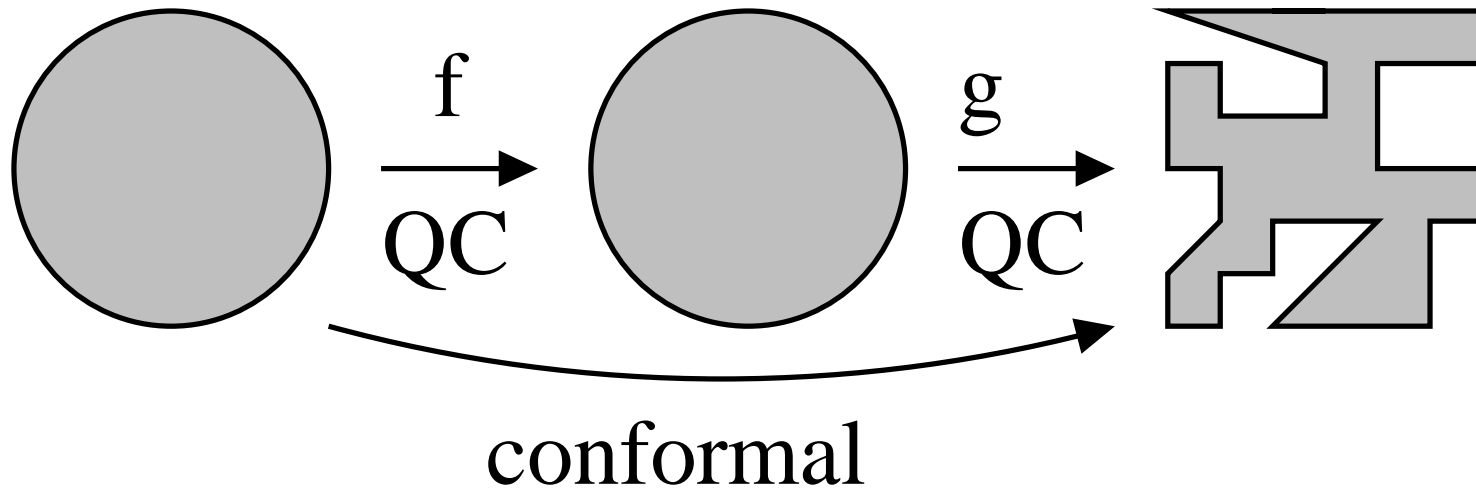

- Find initial QC map  $g$  to polygon.
- Solve a PDE for  $f : \mathbb{D} \rightarrow \mathbb{D}$ .

This talk is about finding a good  $g$ .

RIETMANN

RIETMANN

RIETMANN

RIETMANN

RIETMANN

RIETMANN

RIETMANN

RIETMANN

RIETMANN

RIETMANN

Need initial guess that is **fast** to compute and guaranteed **close** to correct answer.

Need initial guess that is **fast** to compute and guaranteed **close** to correct answer.

- **fast** comes from computational geometry.
- **close** comes from hyperbolic geometry.

## Medial axis:

centers of disks that hit boundary in at least two points.

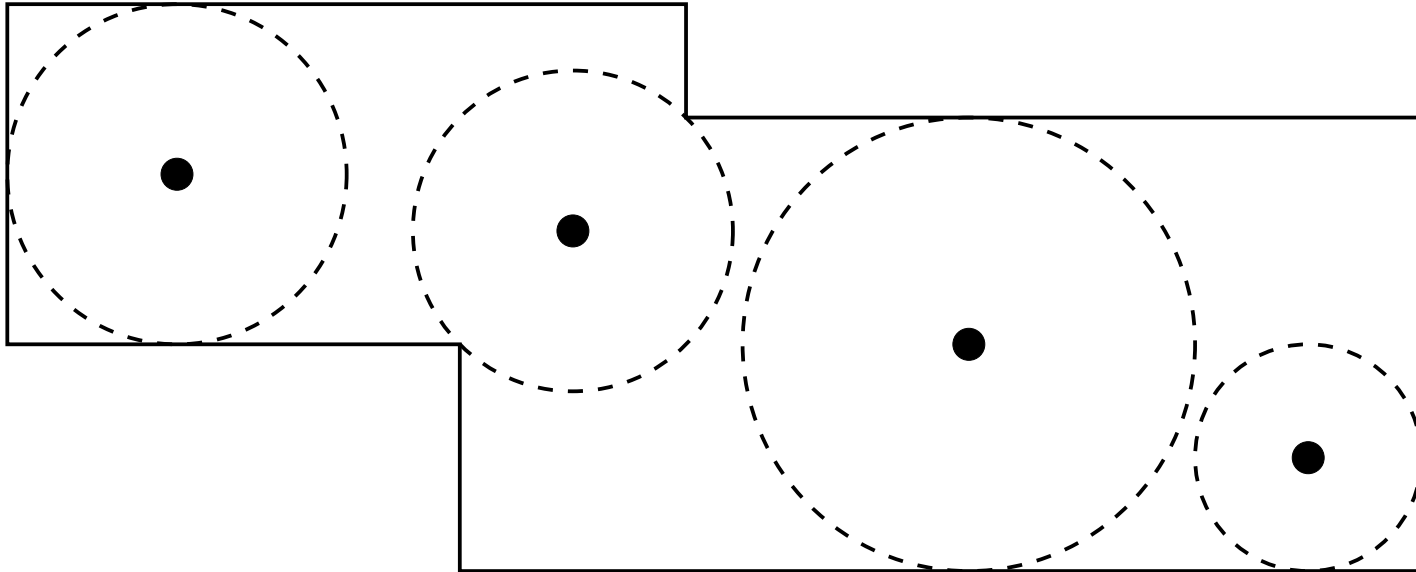

## Medial axis:

centers of disks that hit boundary in at least two points.

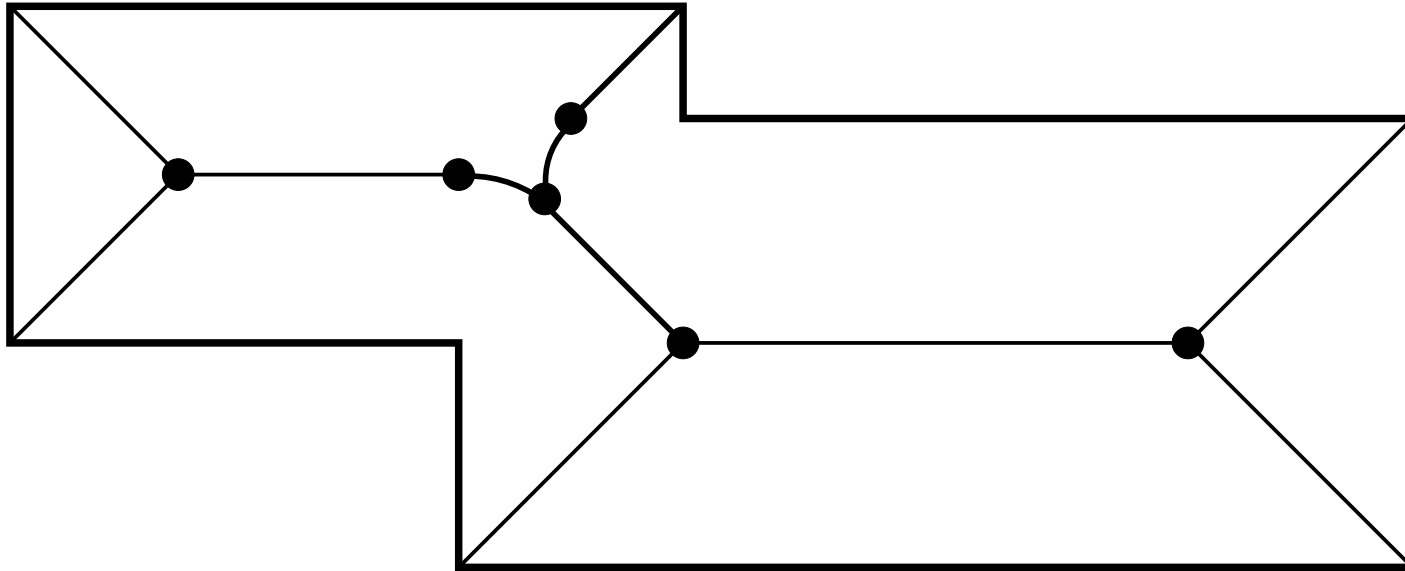

Medial axis of a polygon is a finite tree.

Computable in  $O(n)$ , Chin-Snoeyink-Wang (1999).

Related to Voronoi diagrams: medial axis divides polygon interior according to nearest edge.

**Medial axis:**

centers of disks that hit boundary in at least two points.

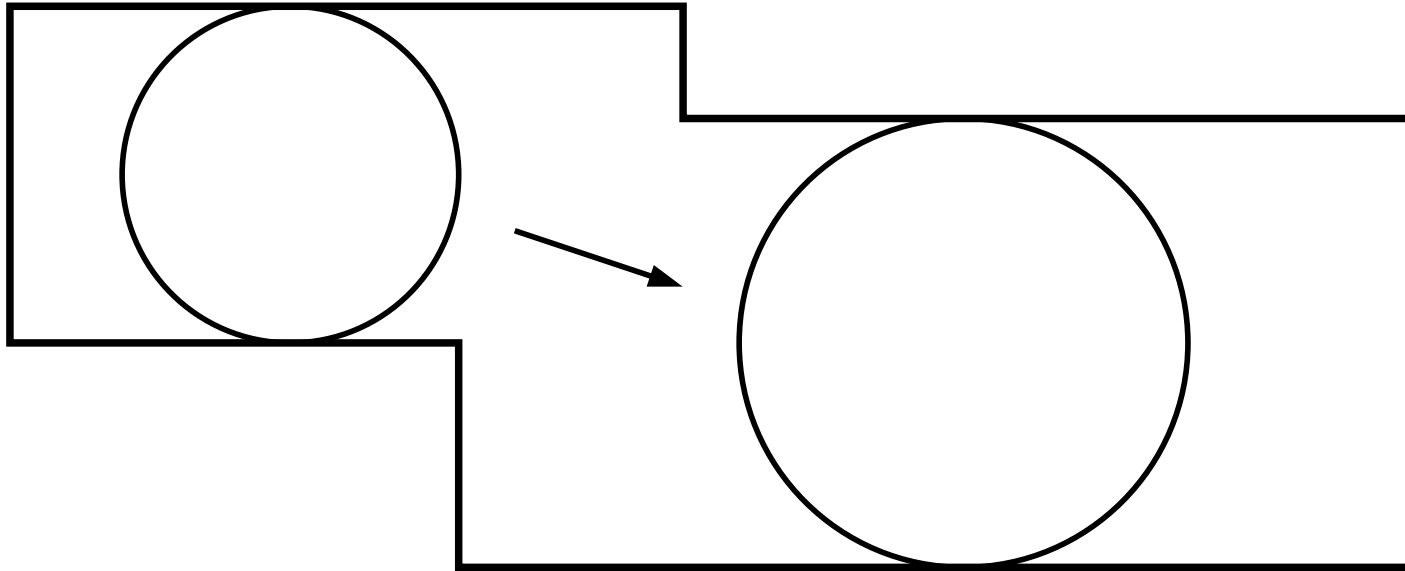

**Claim:** there is a “natural” choice of conformal map between any two medial axis disks.

A **Möbius transformation** is a map of the form

$$z \rightarrow \frac{az + b}{cz + d}.$$

Conformally maps disks to disks (or half-planes).

Form a group under composition.

Uniquely determined by images of 3 distinct points.

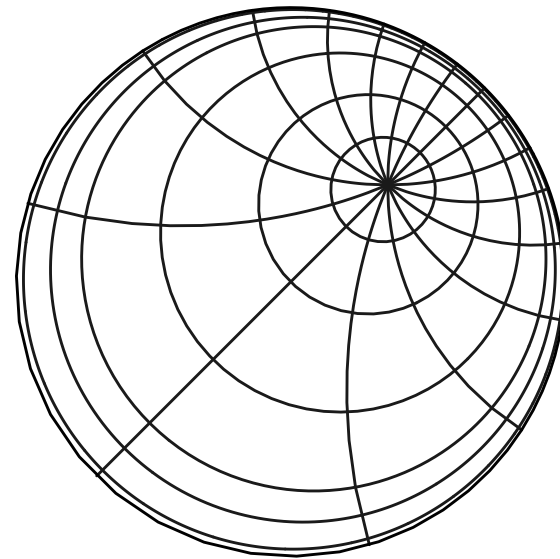
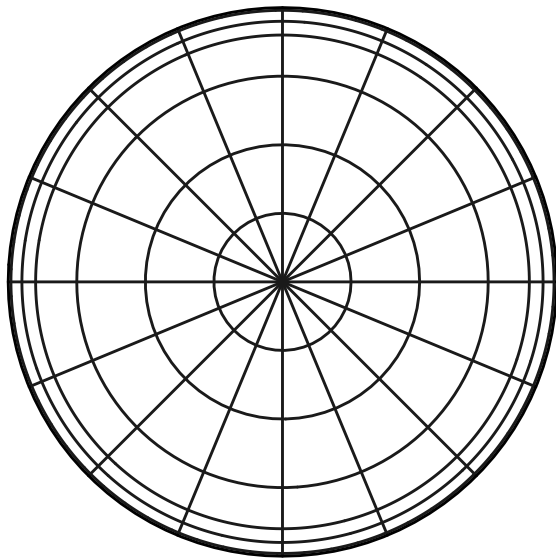



Intersecting circles:

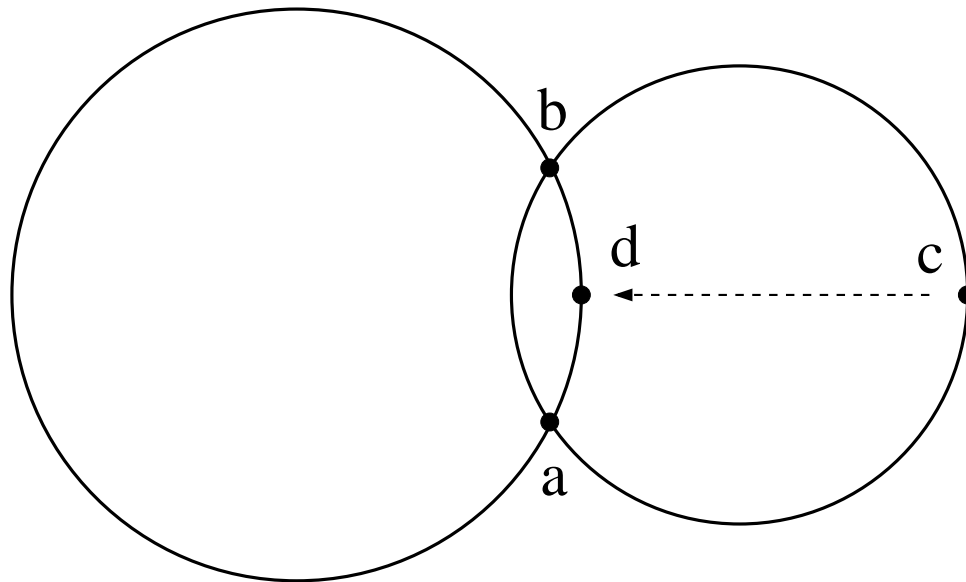

Fix intersection points  $a, b$  and map  $c \rightarrow d$  as shown.

Determines unique Möbius map between disks.

Part of 1-parameter symmetric family fixing  $a, b$ .

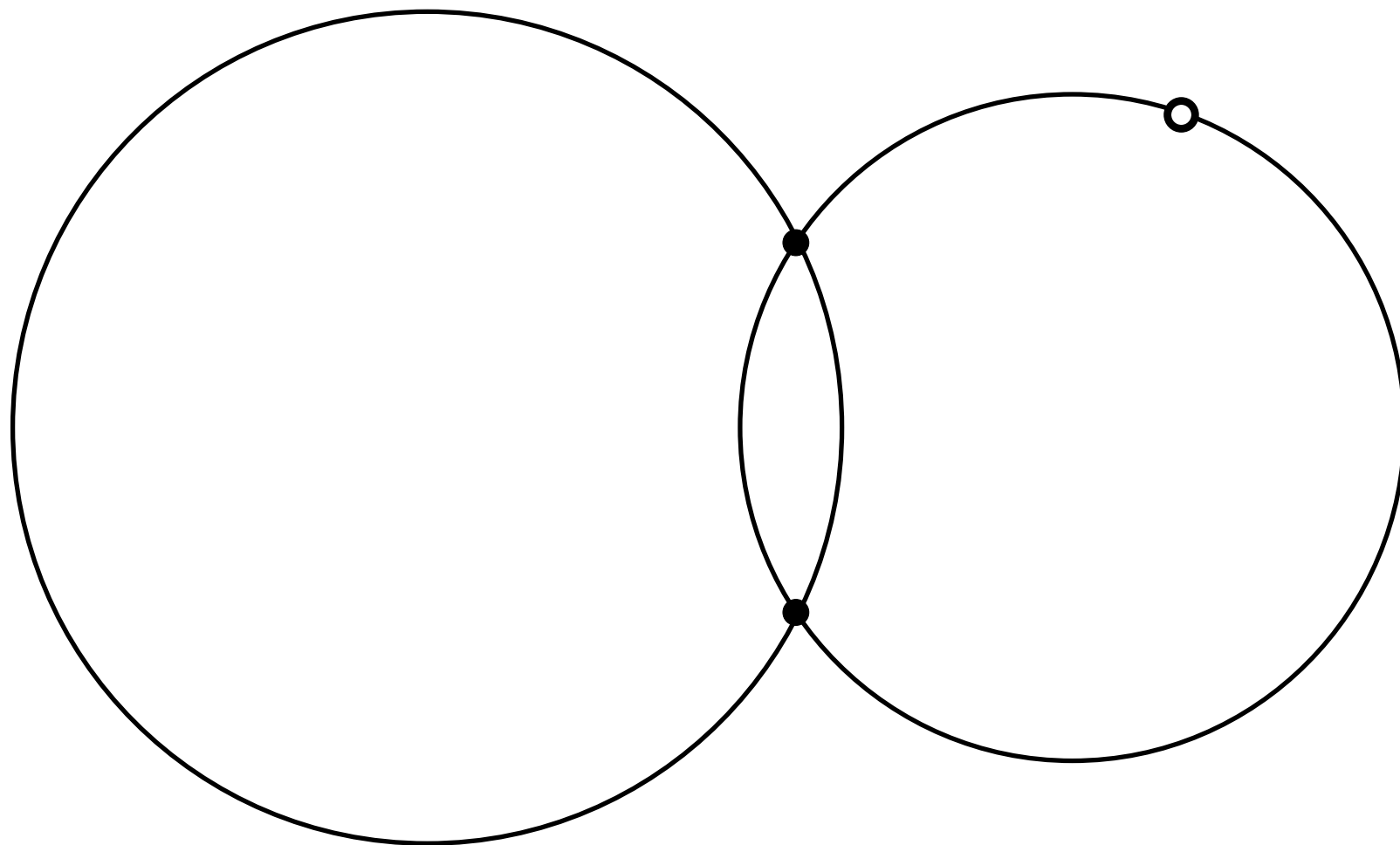

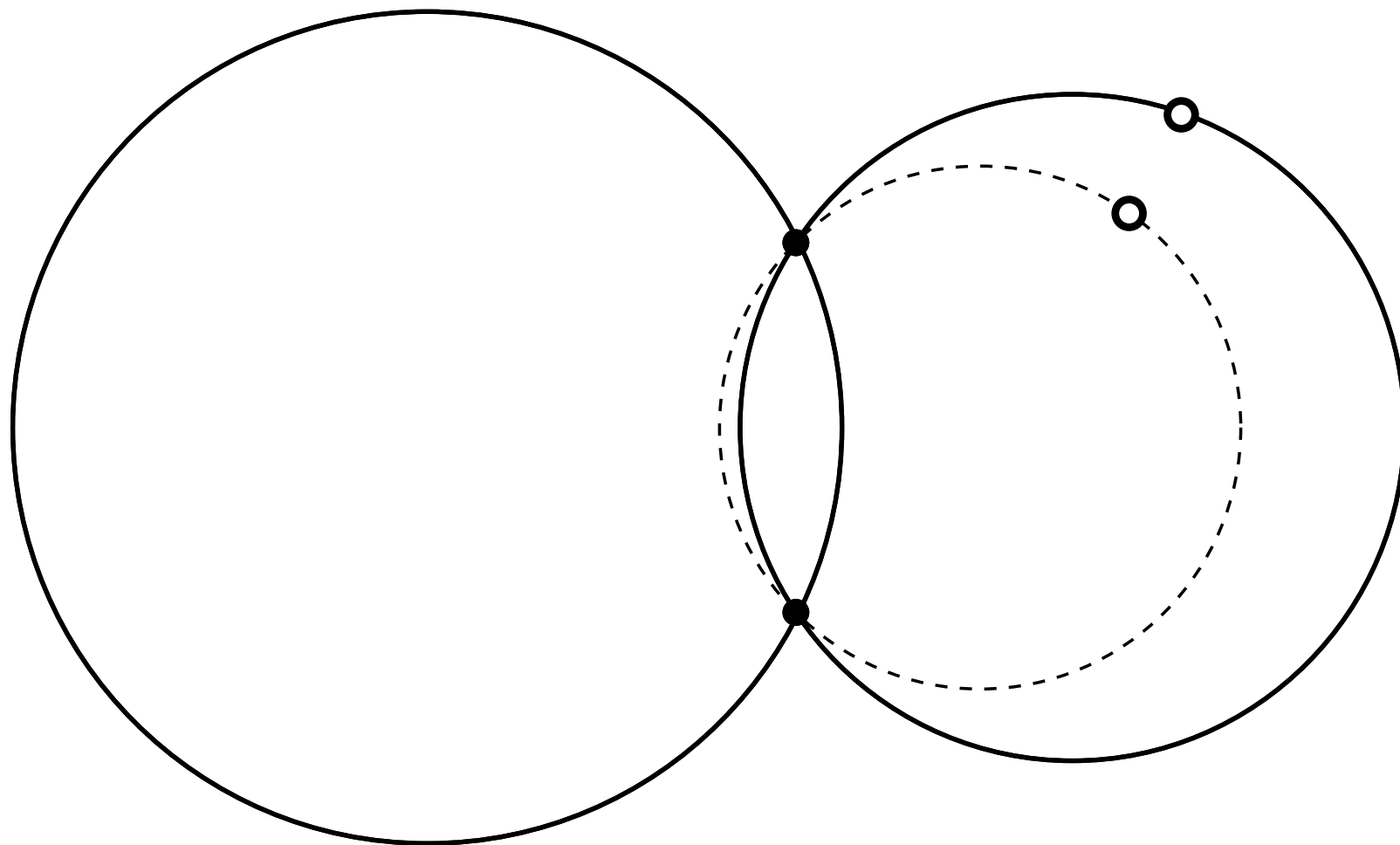

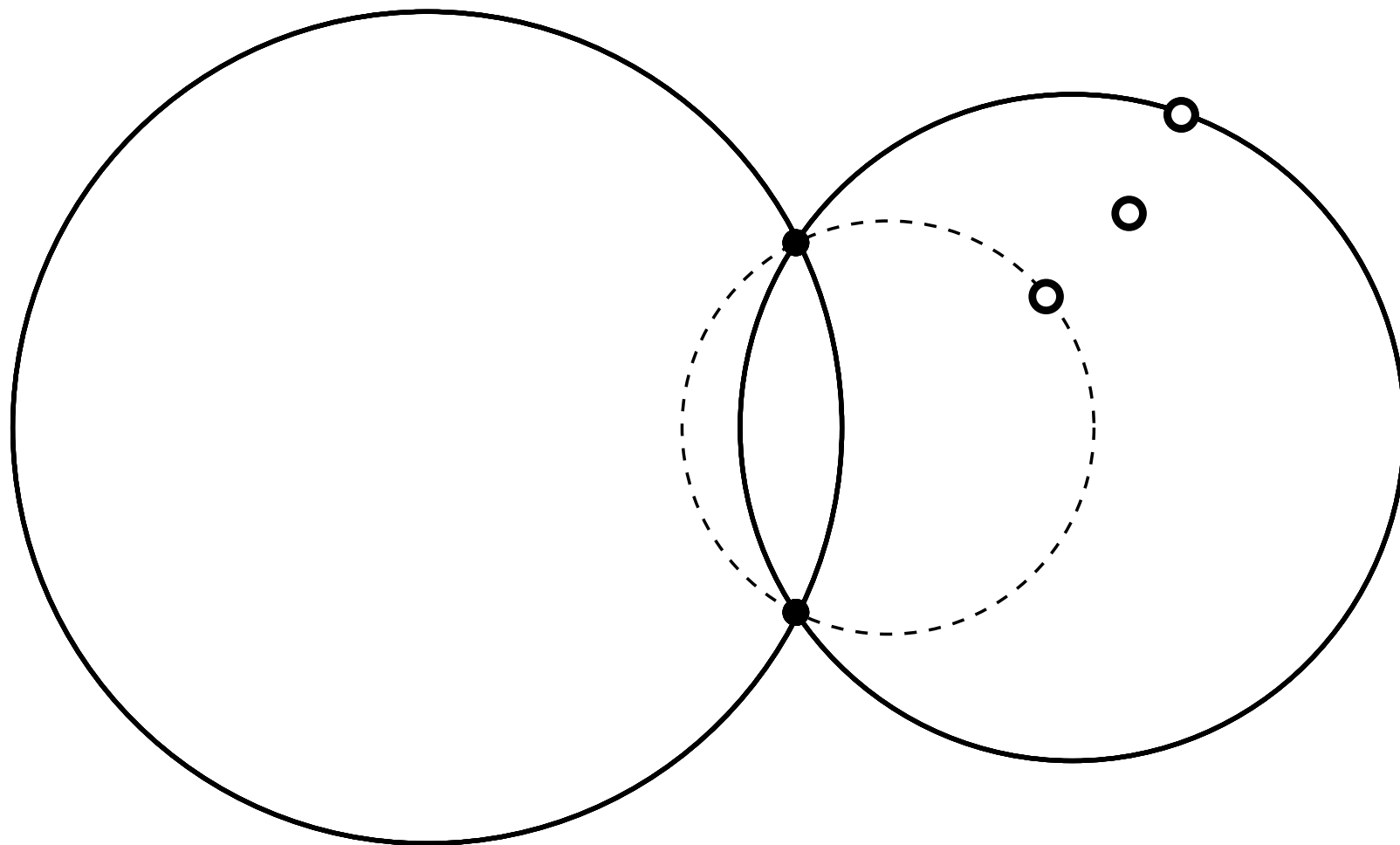

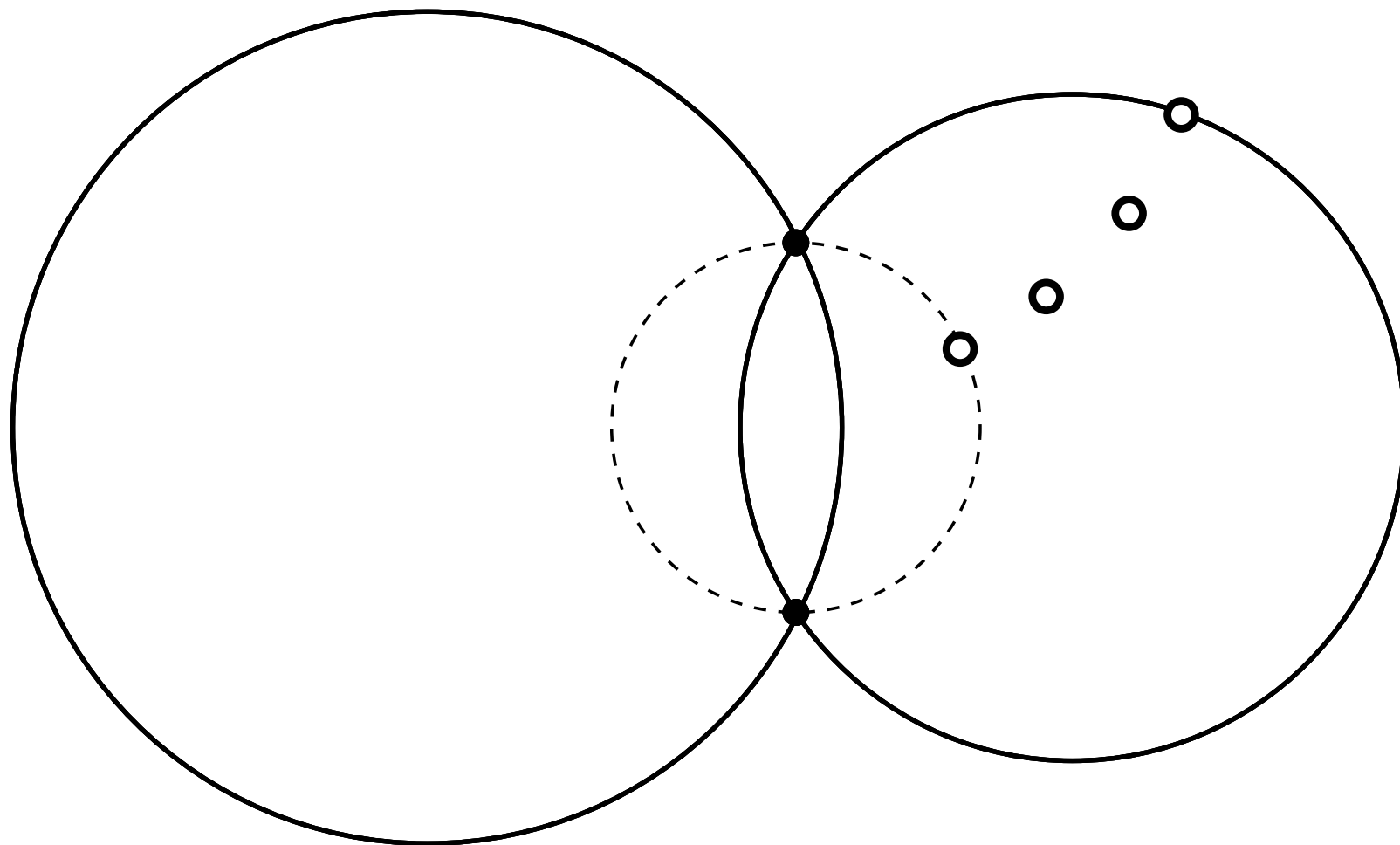

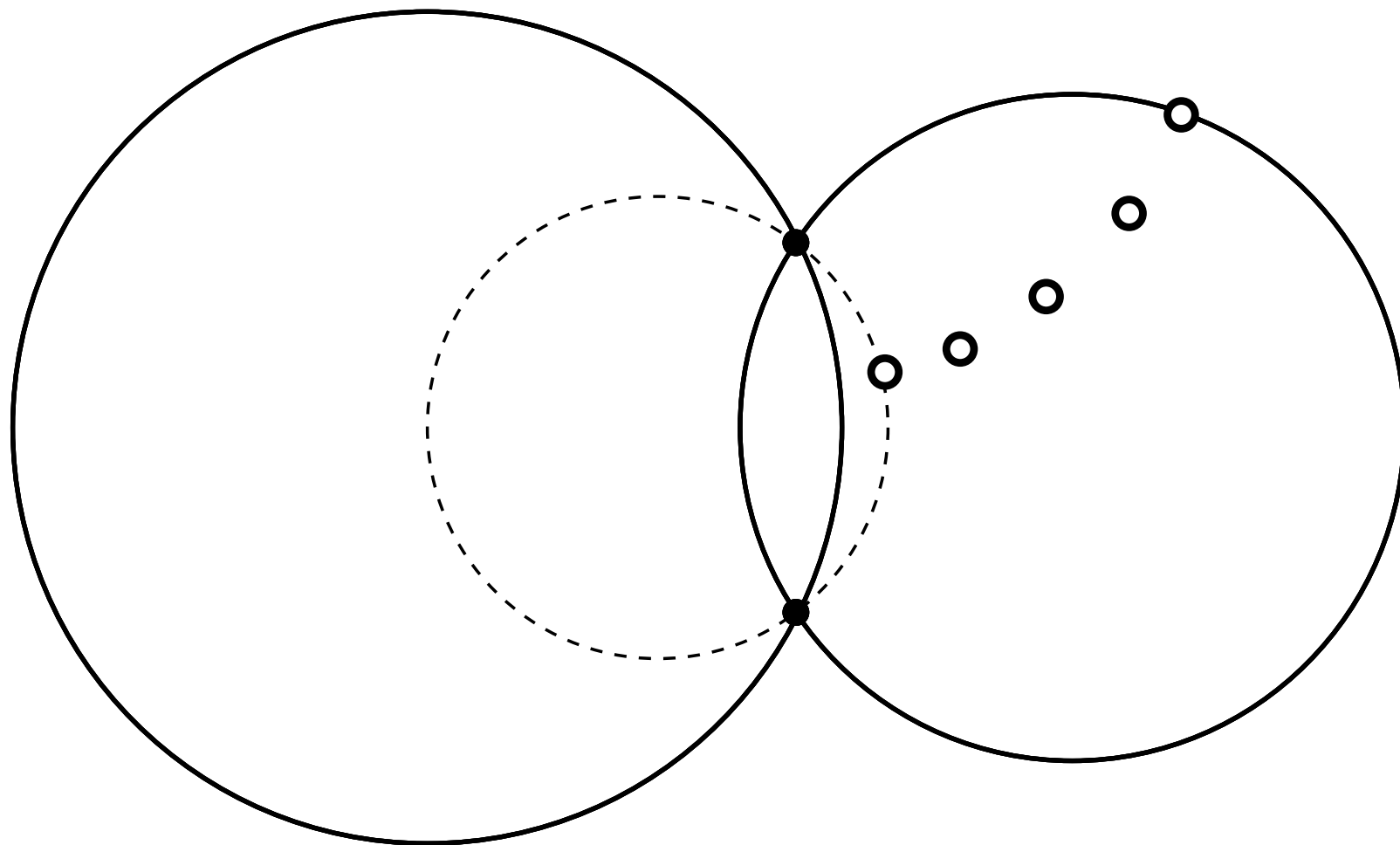

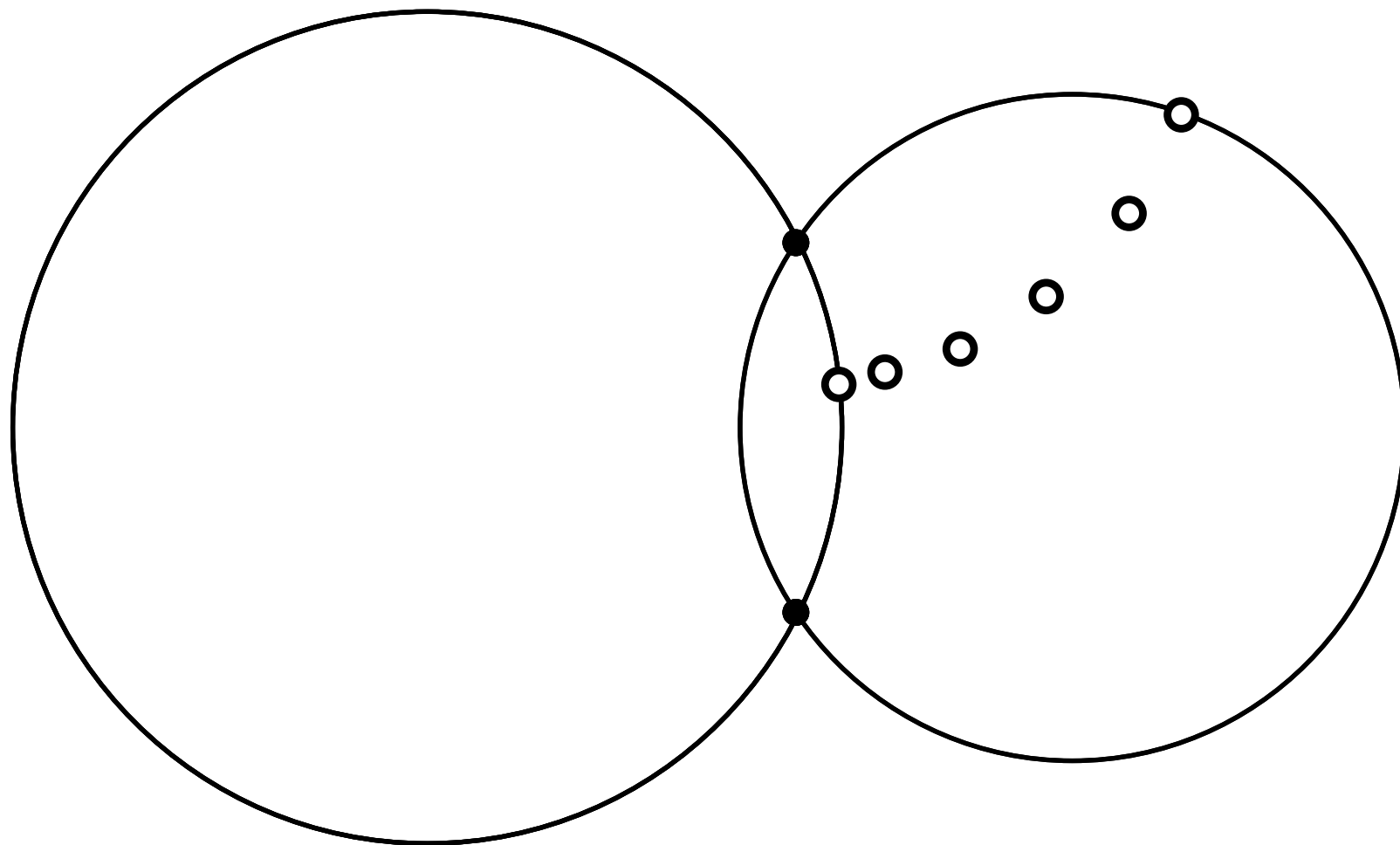

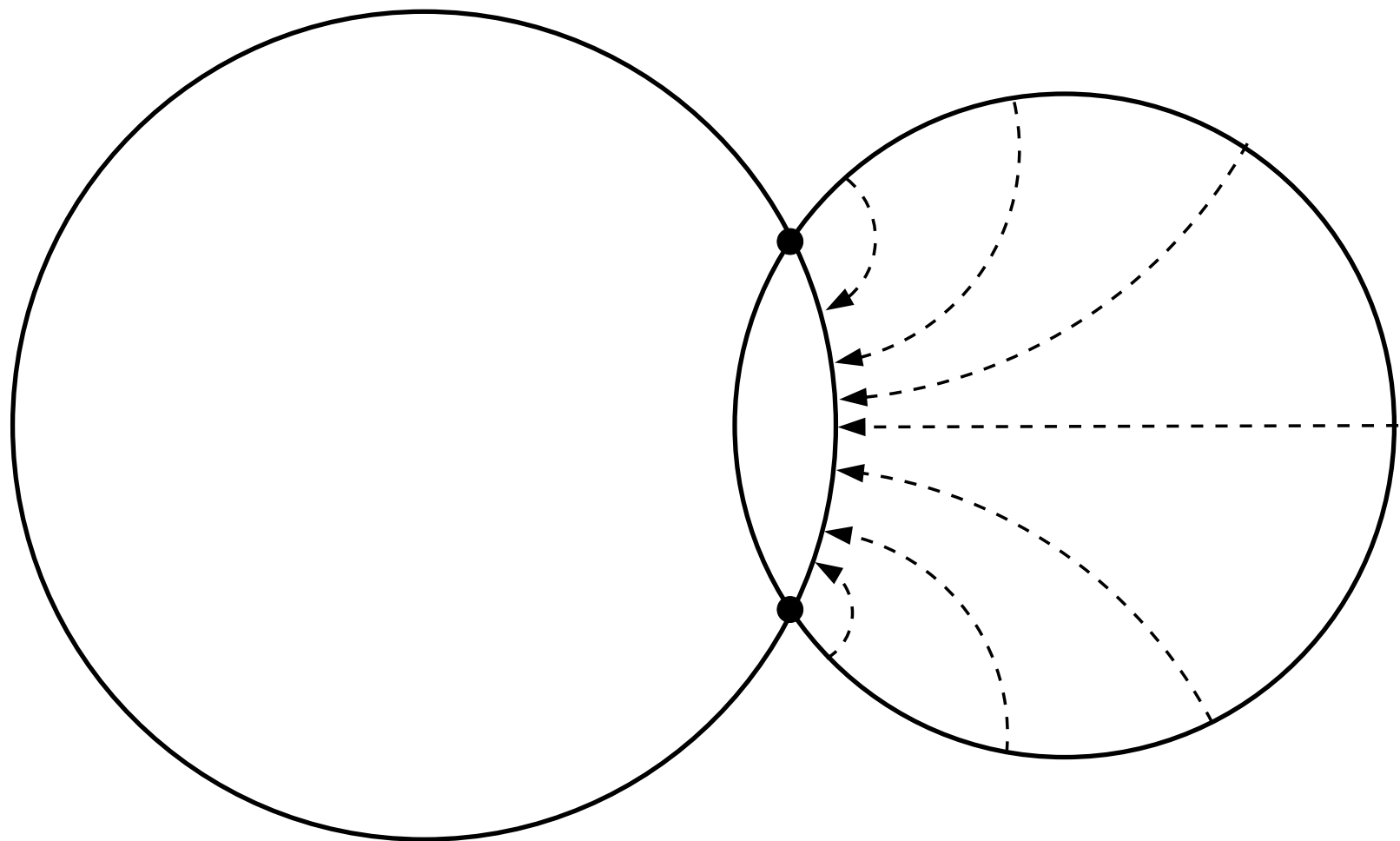

Points follow circular paths, perpendicular to boundary.



How does this give a map from polygon  $P$  to a circle?

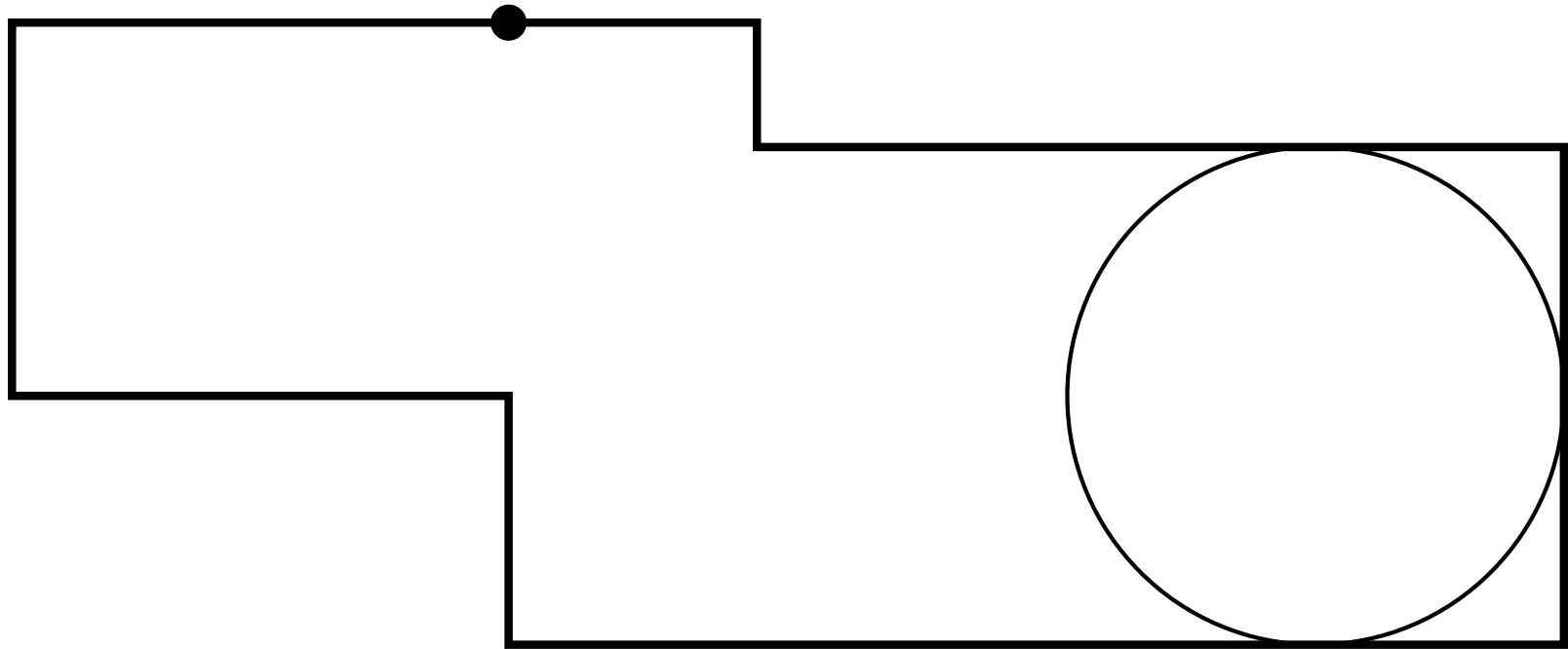

- Fix a “root” MA disk  $D$ .

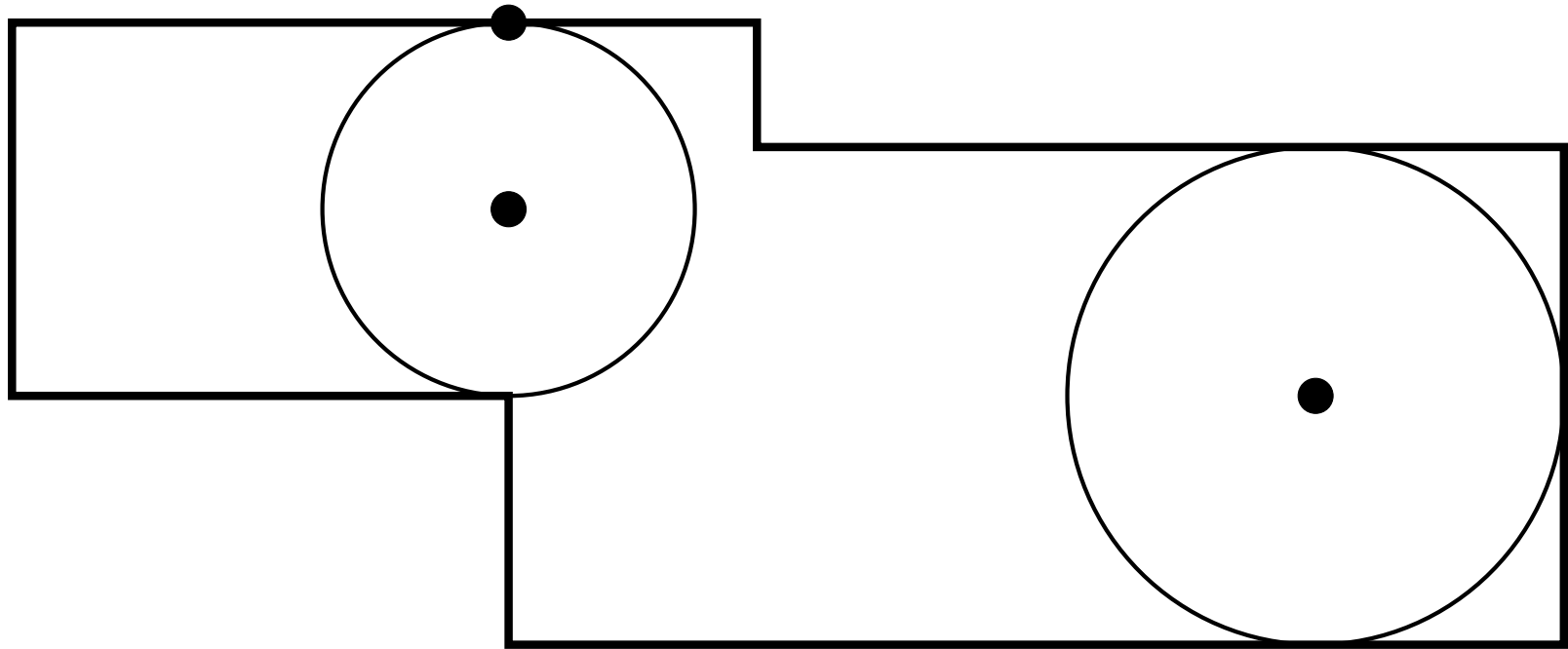

- For any  $z \in P$ , take MA disk  $D_z$  touching  $z$ .

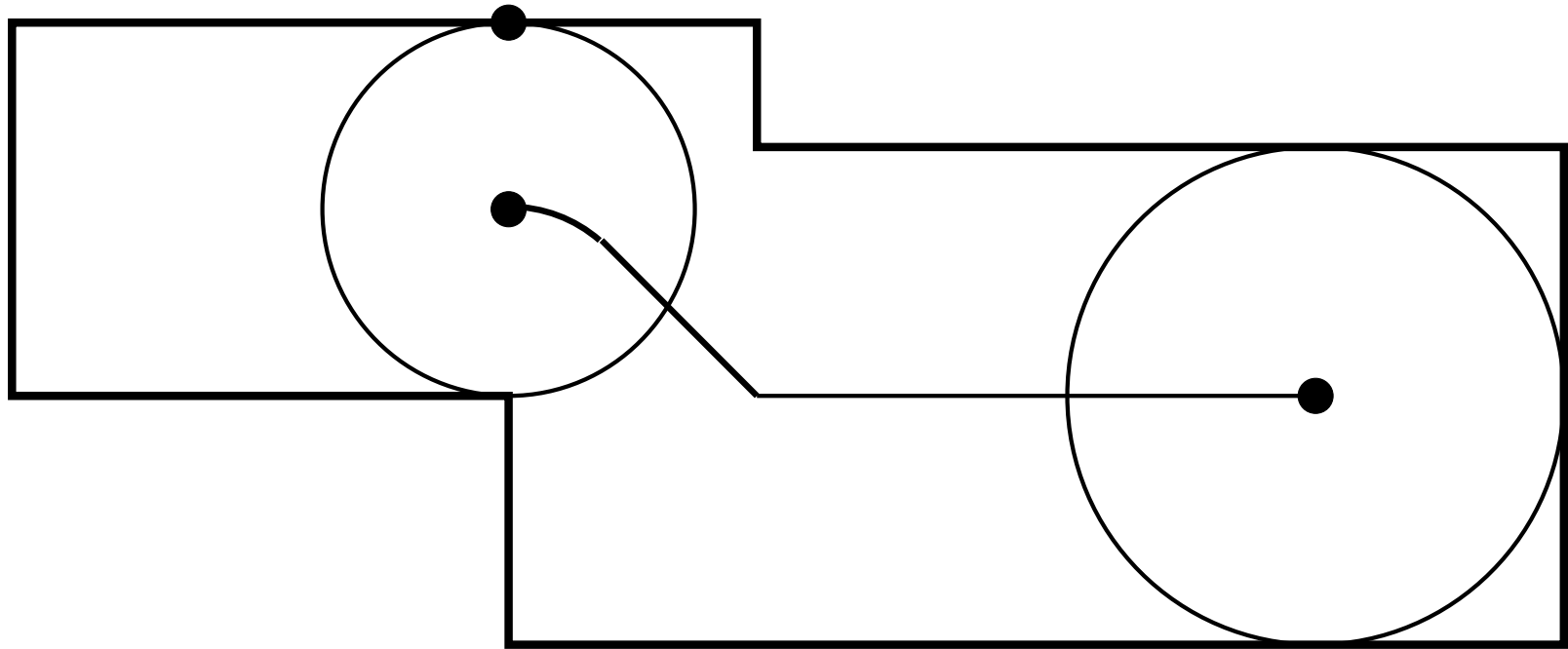

- Connect  $D_z$  to  $D$  on MA.

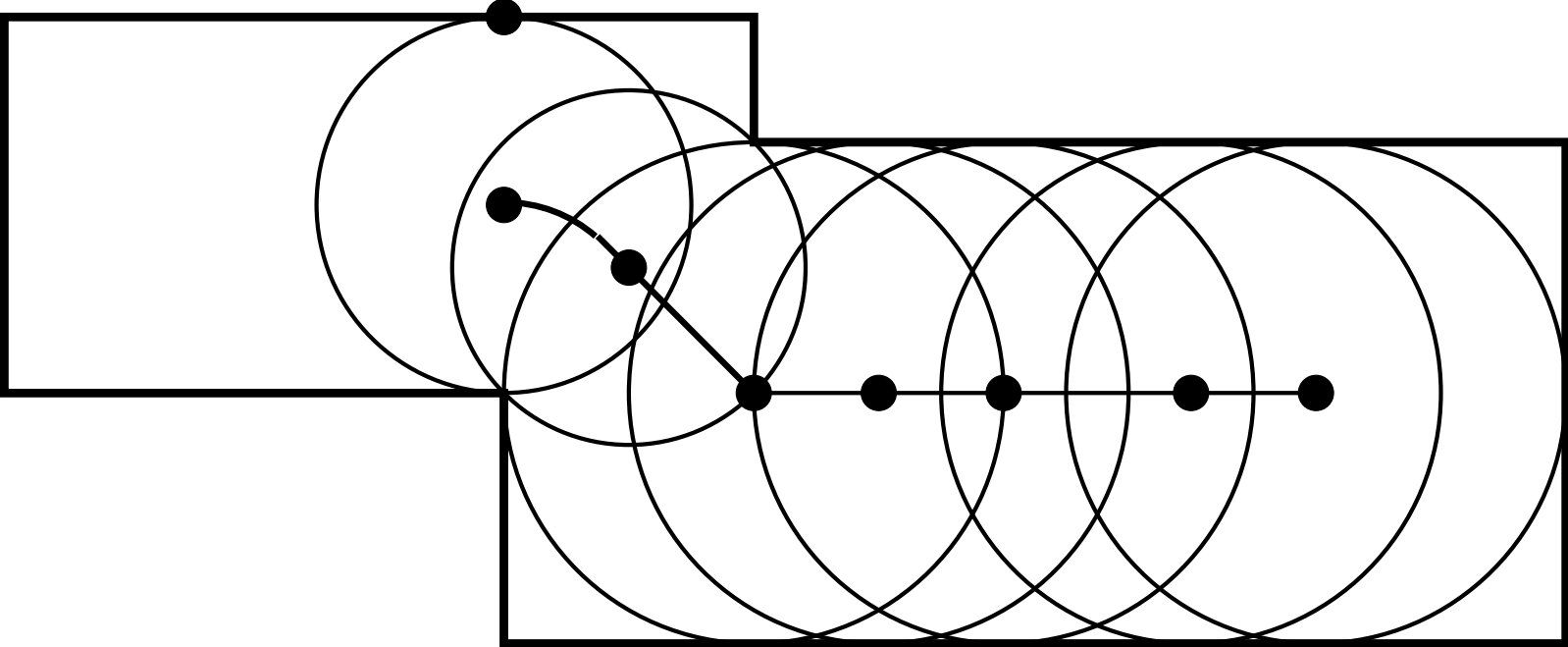

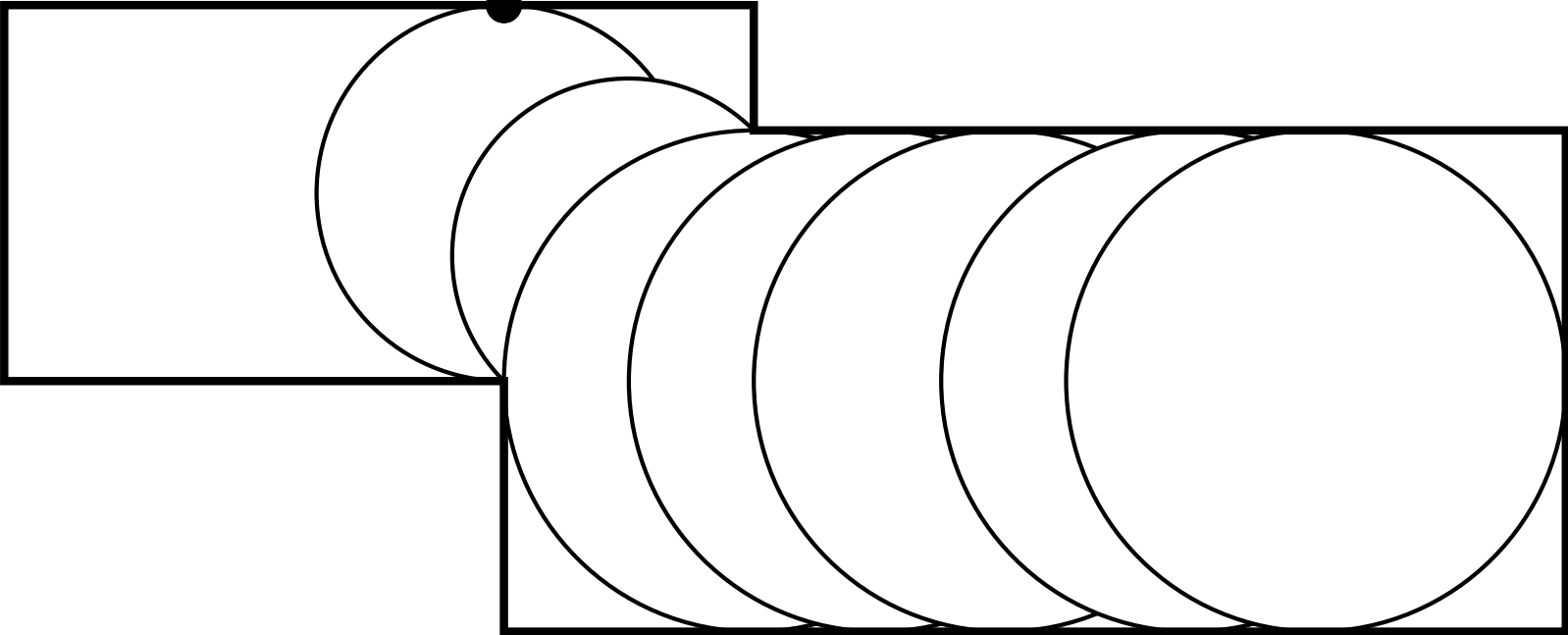

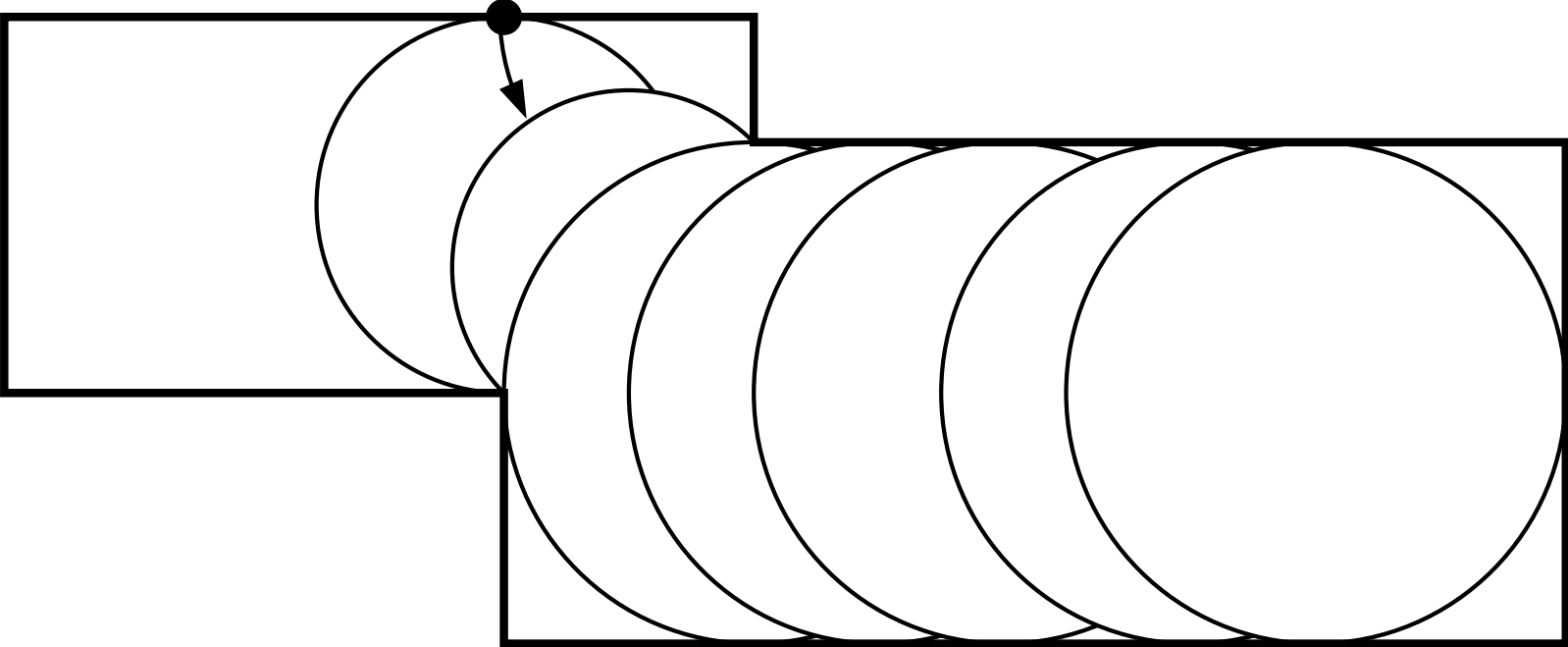

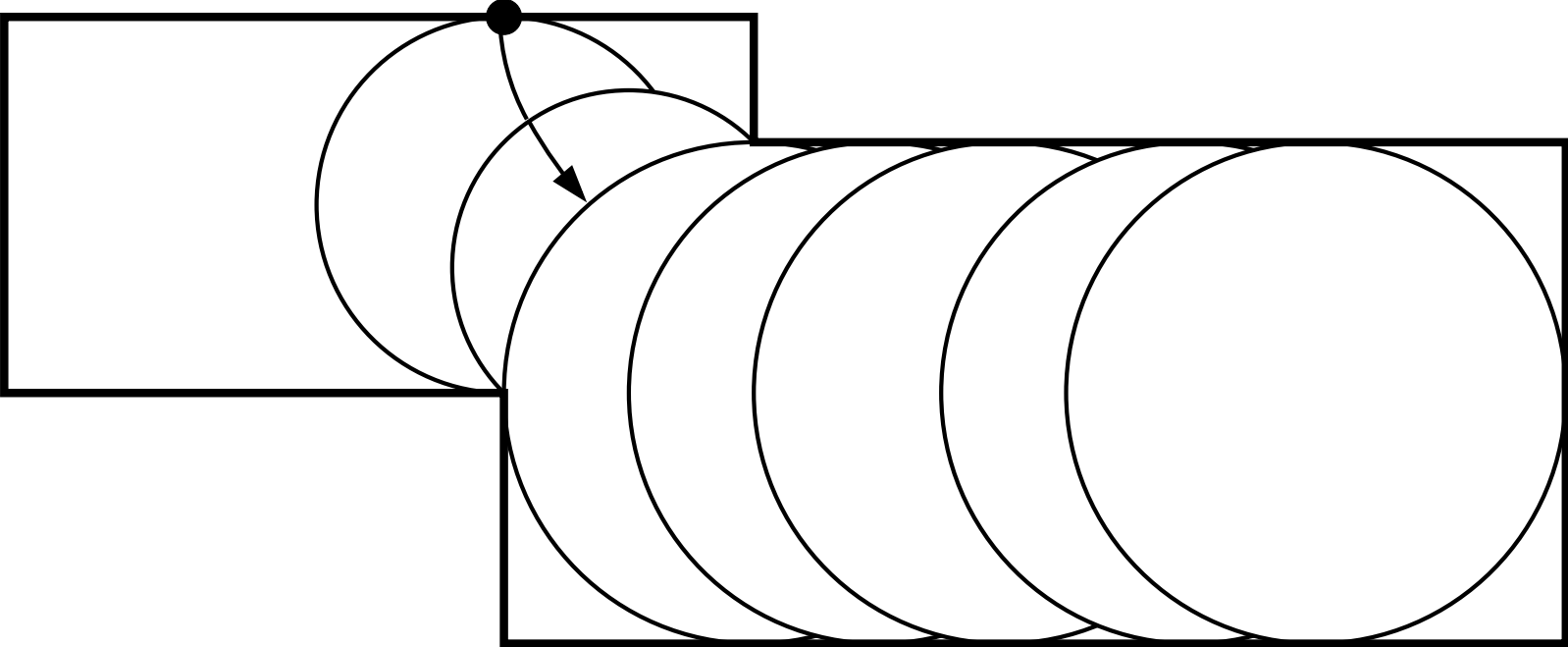



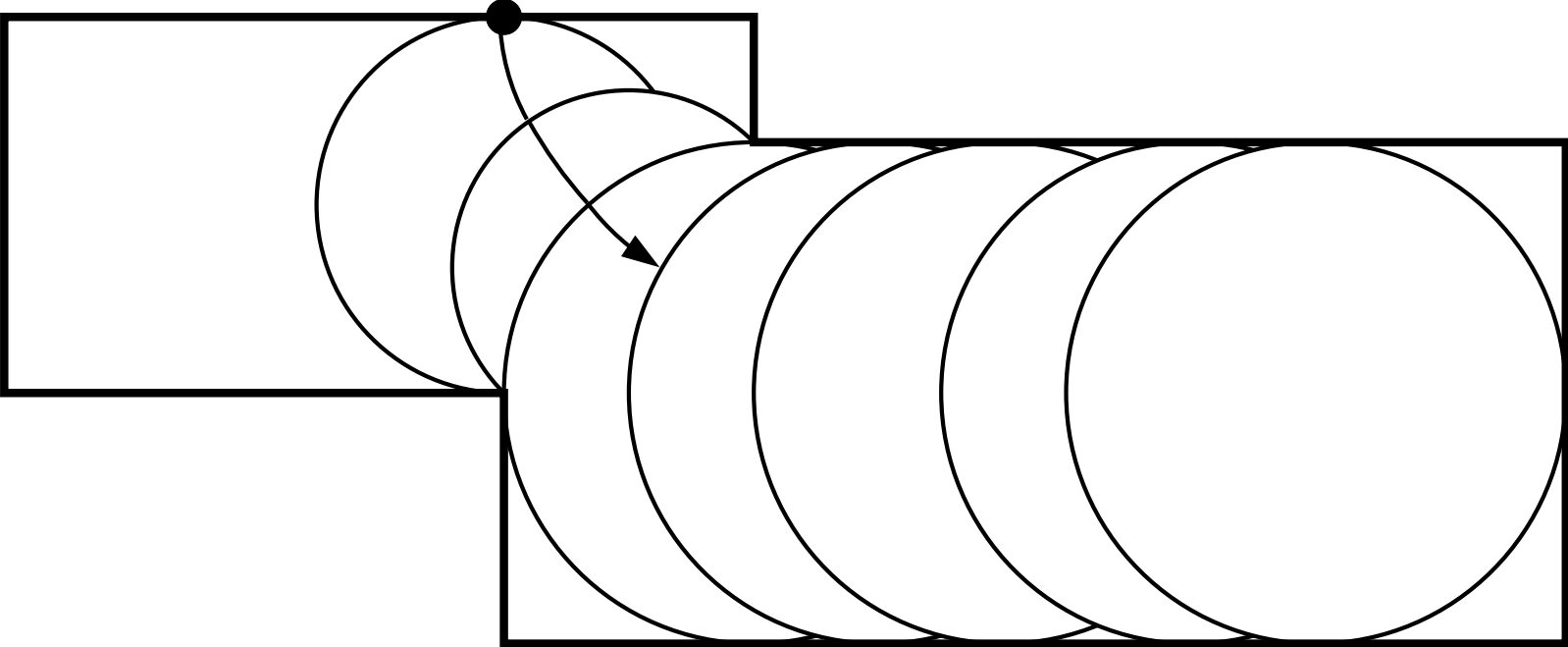

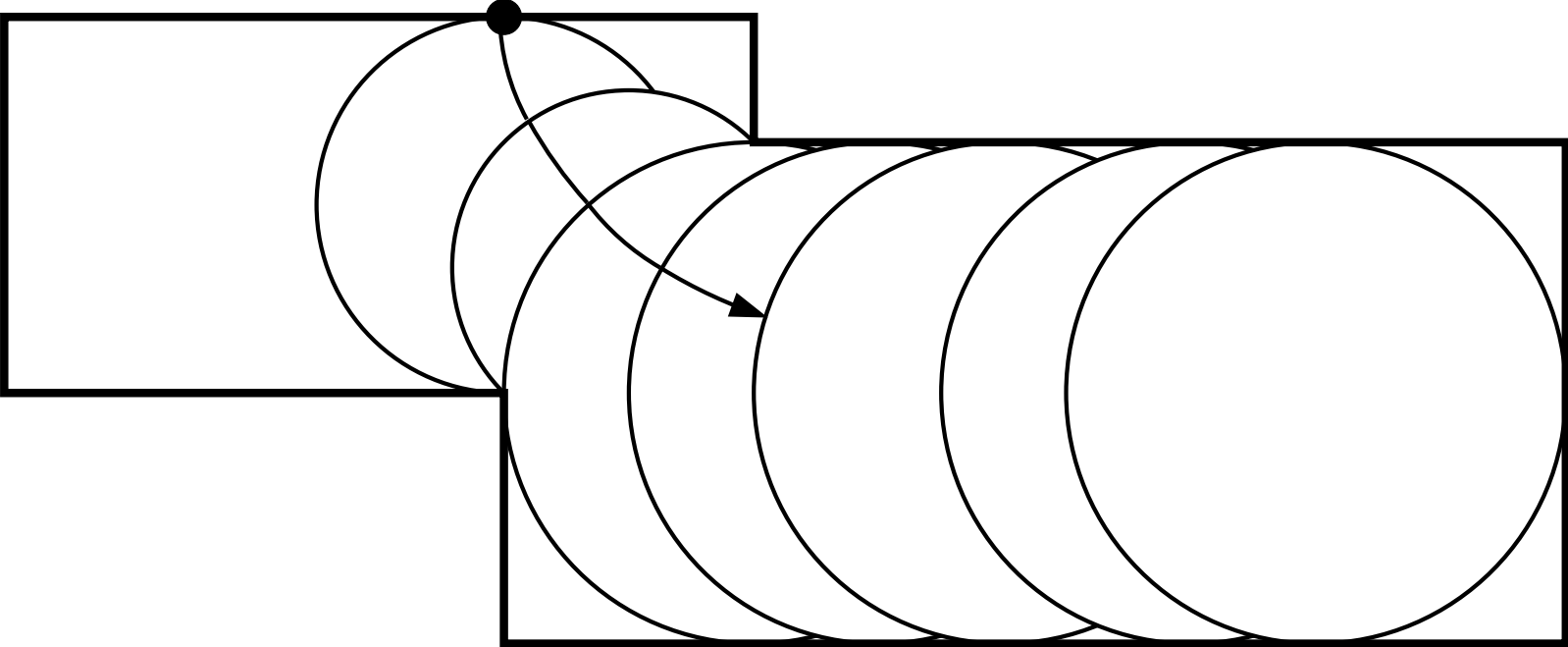

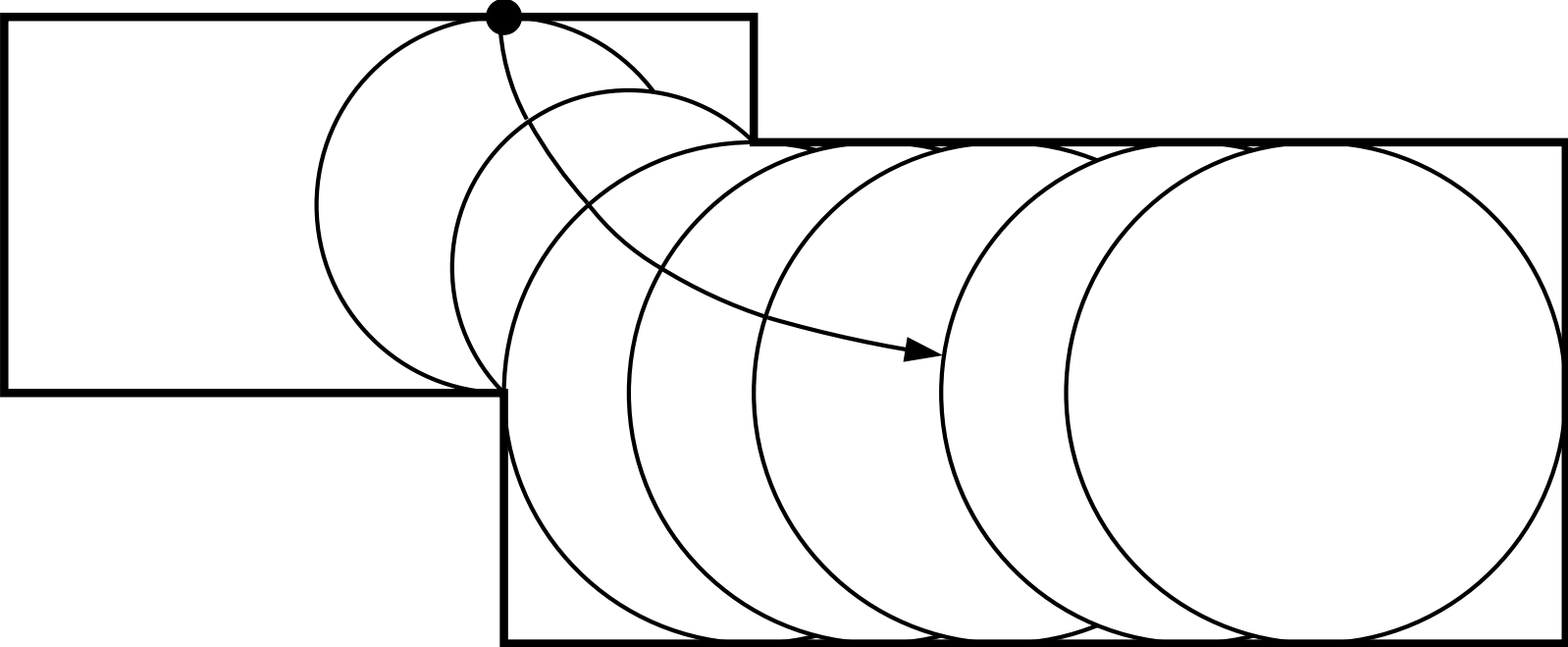

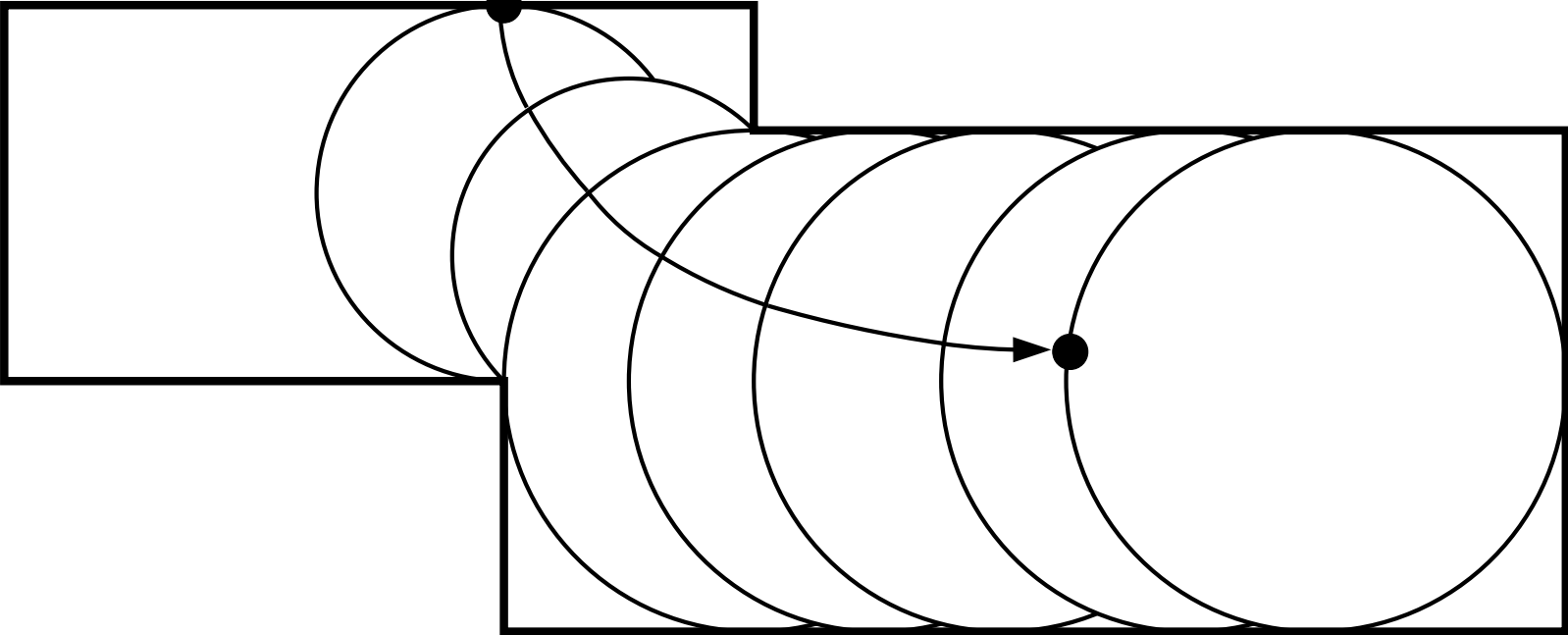

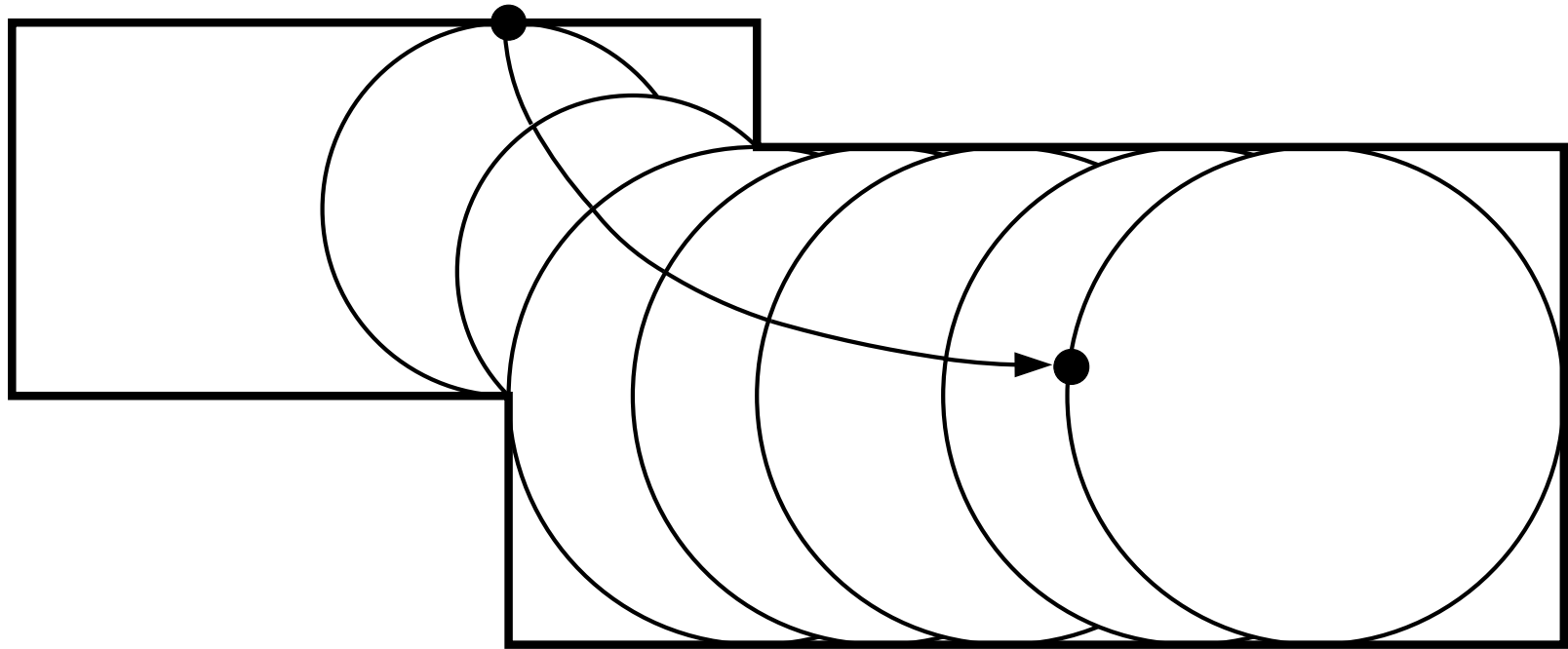

We discretize only to draw picture.

Limiting map has **formula** in terms of medial axis.

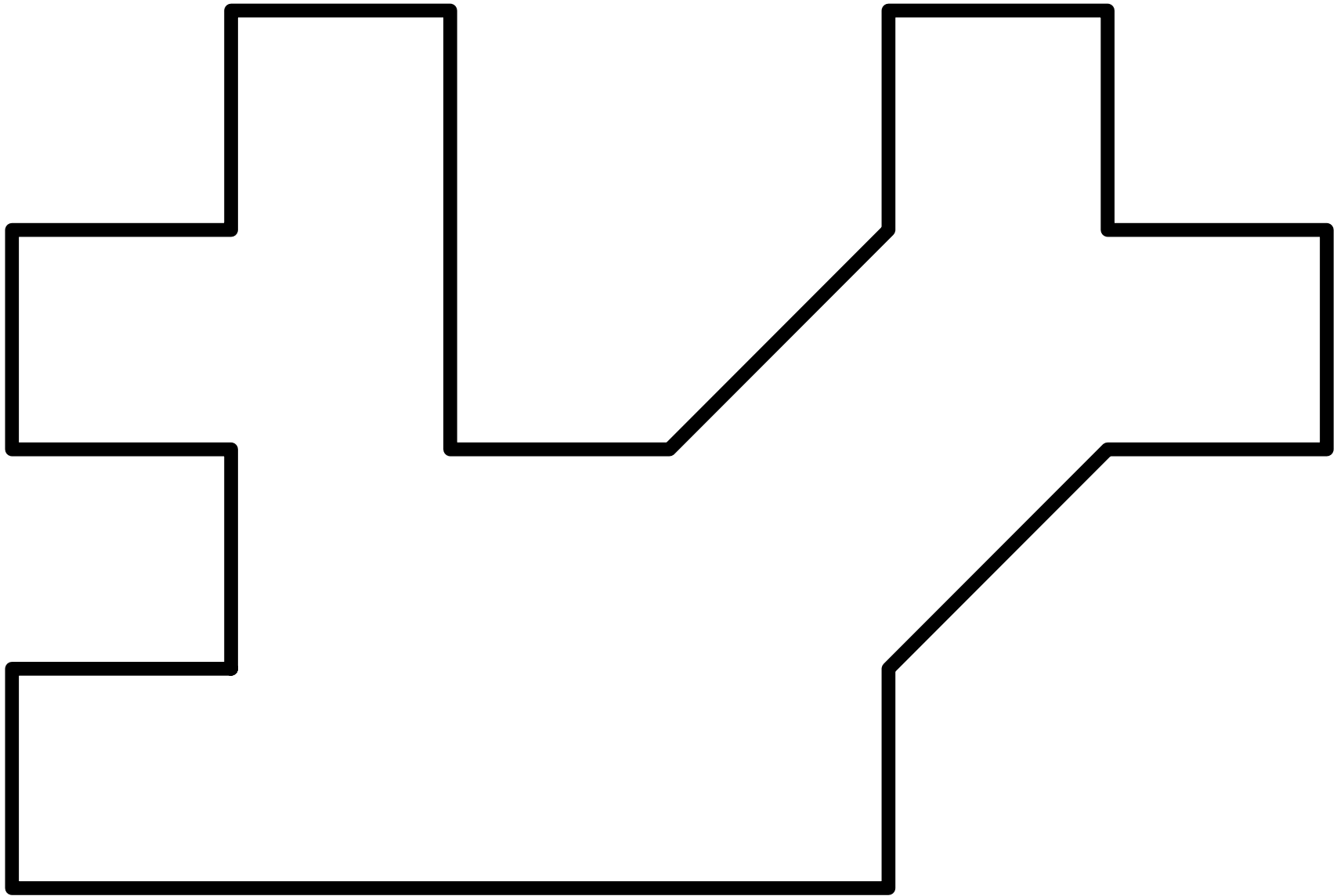

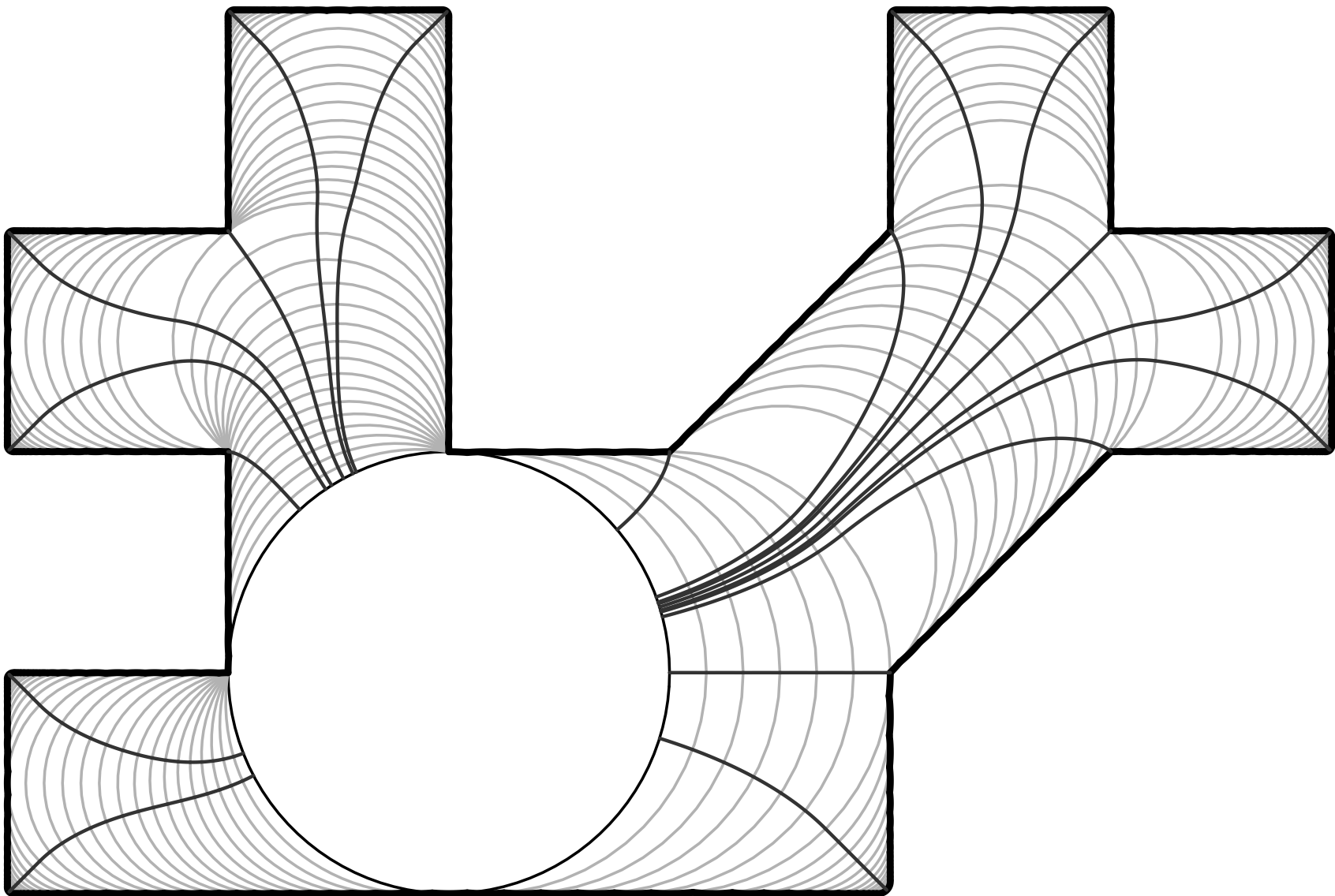

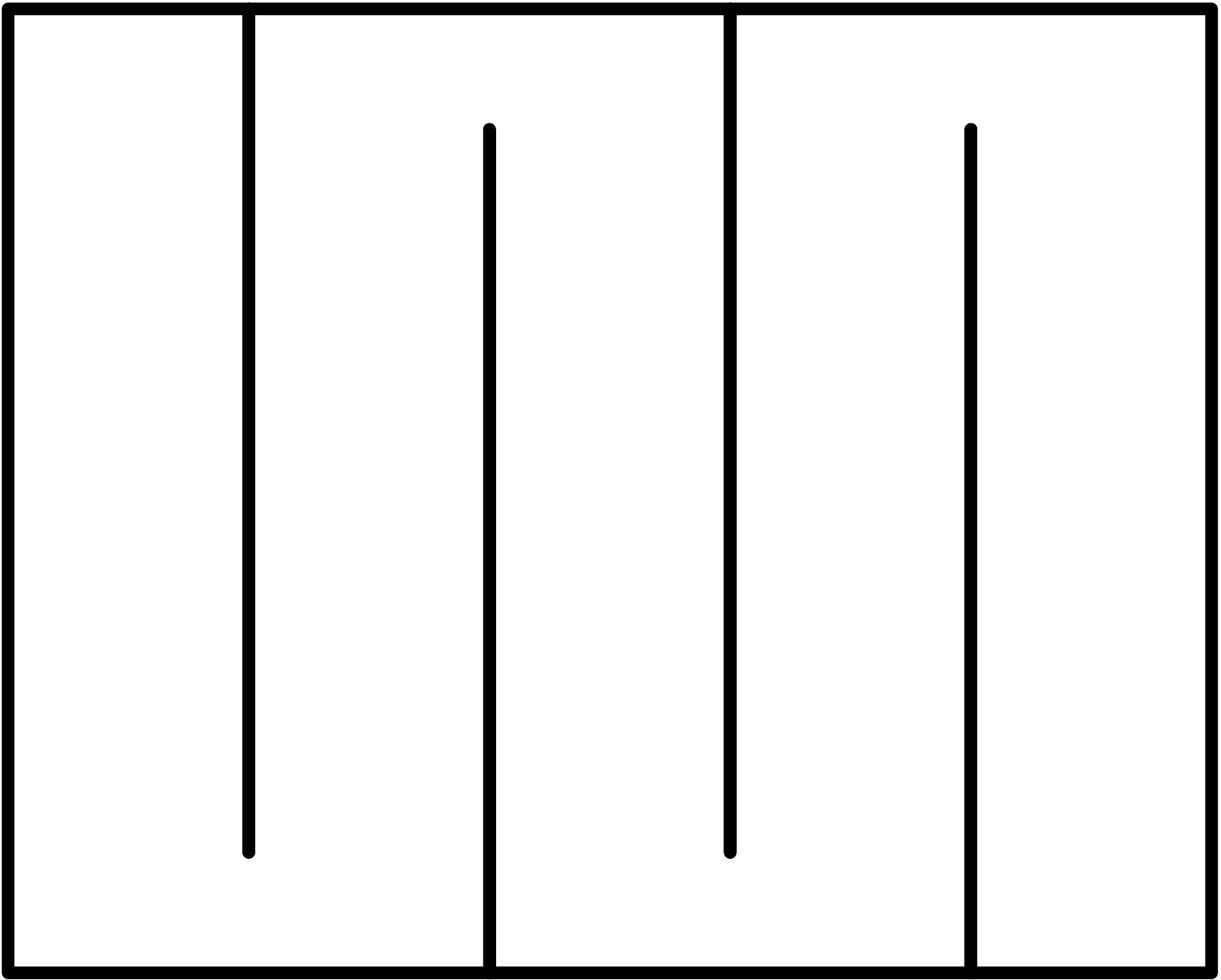



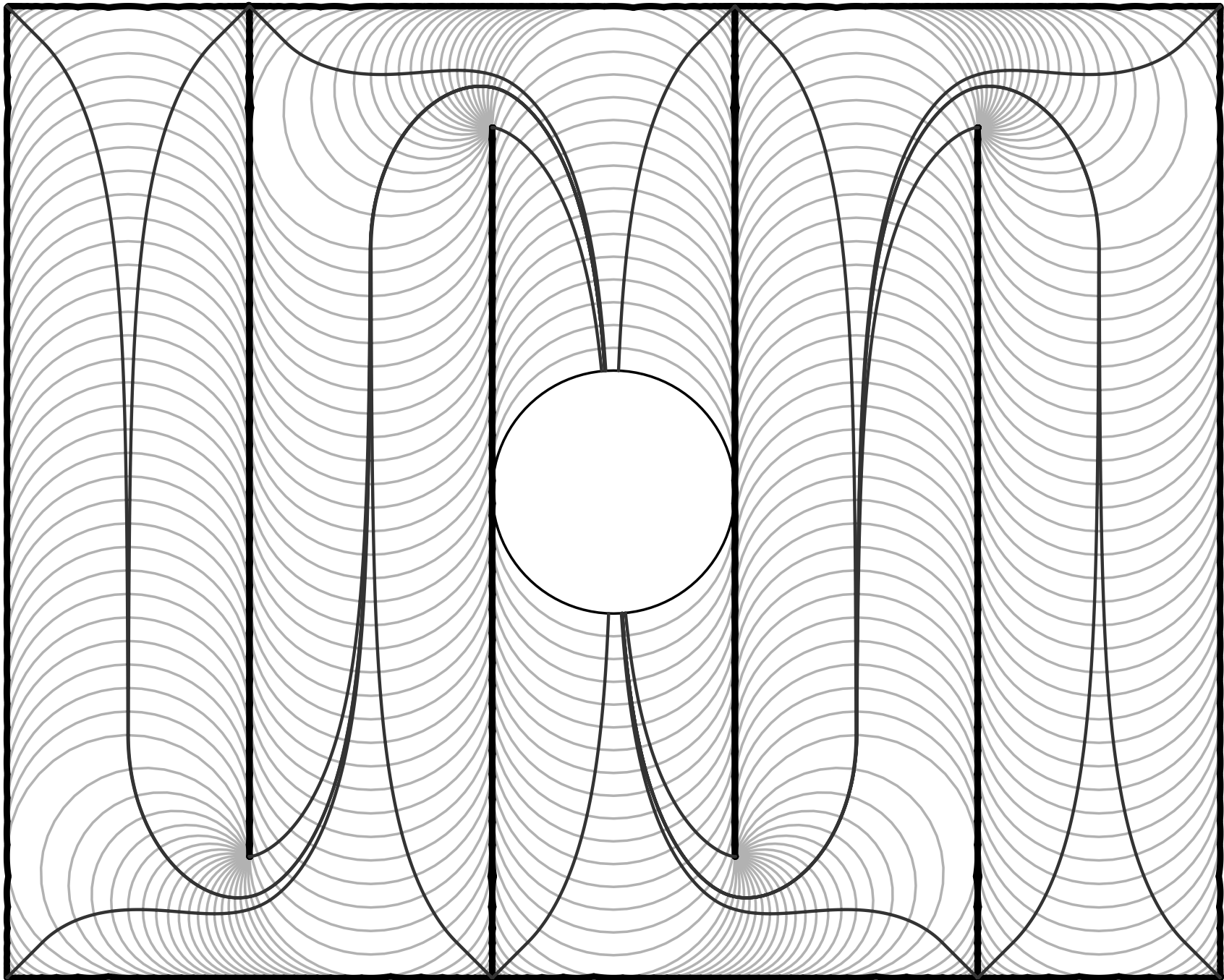

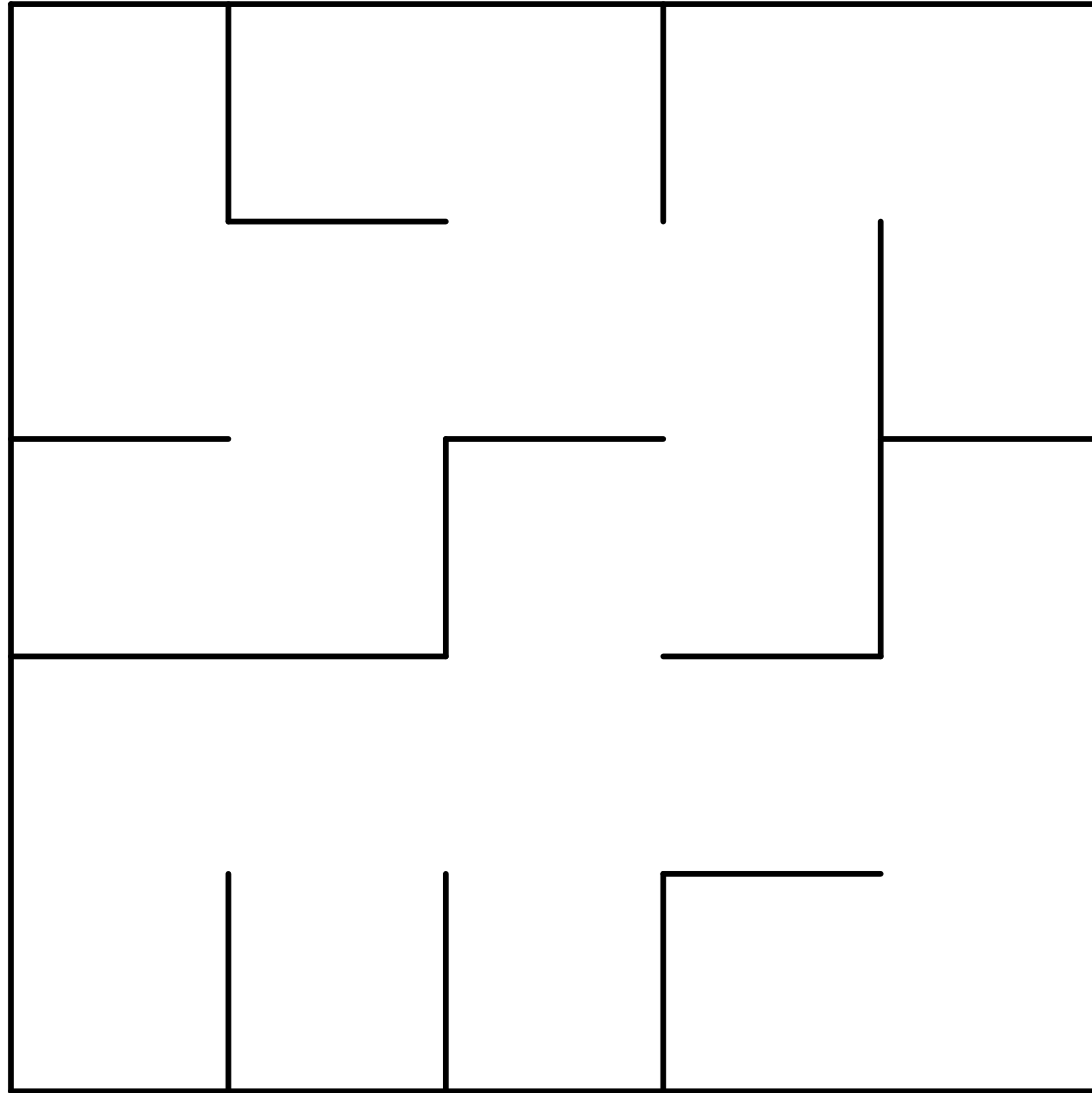

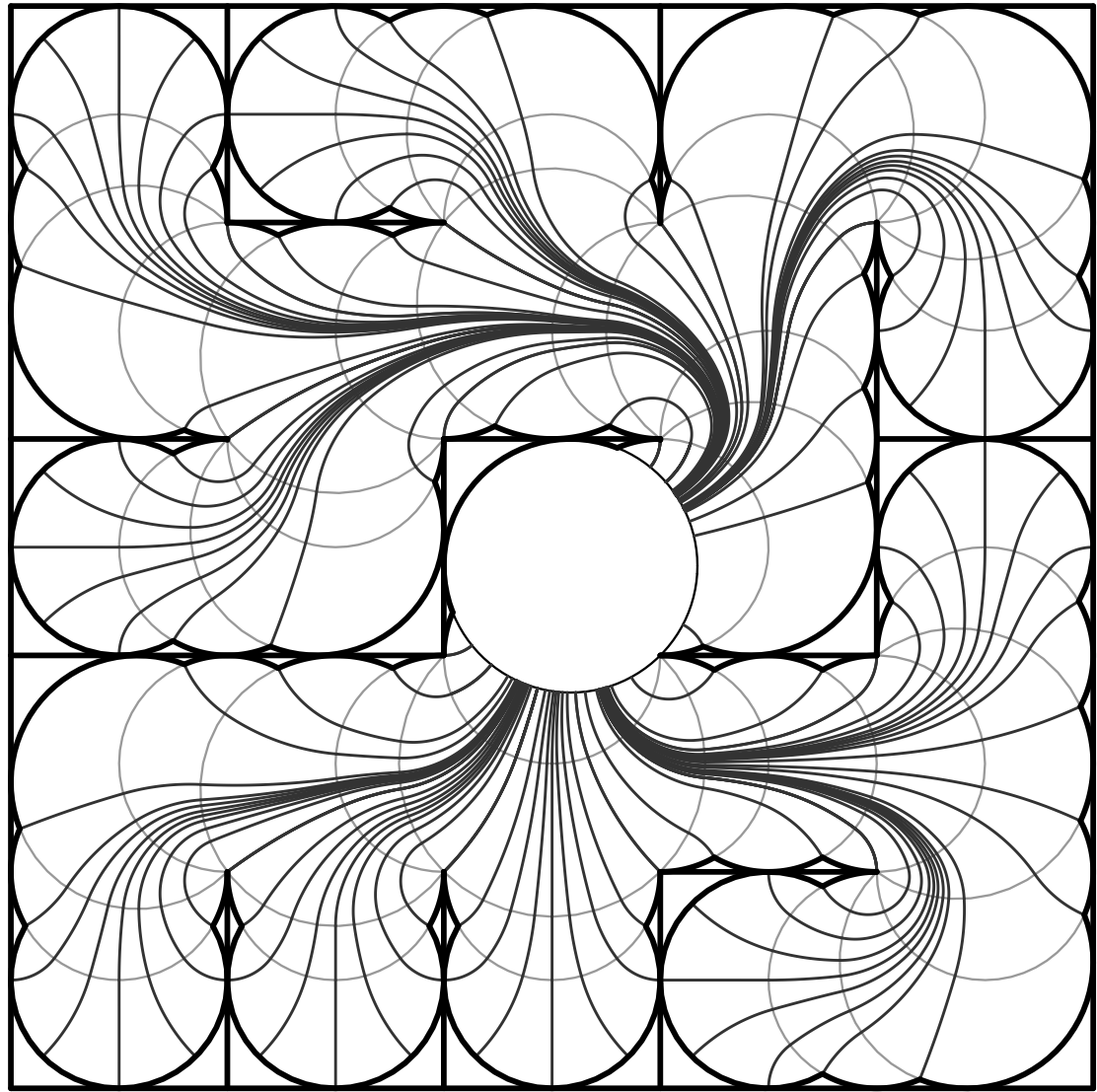

**Theorem:** Mapping all  $n$  vertices takes  $O(n)$  time.

Uses linear time computation of MA (Chin-Snoeyink-Wang) and book-keeping with cross ratios.

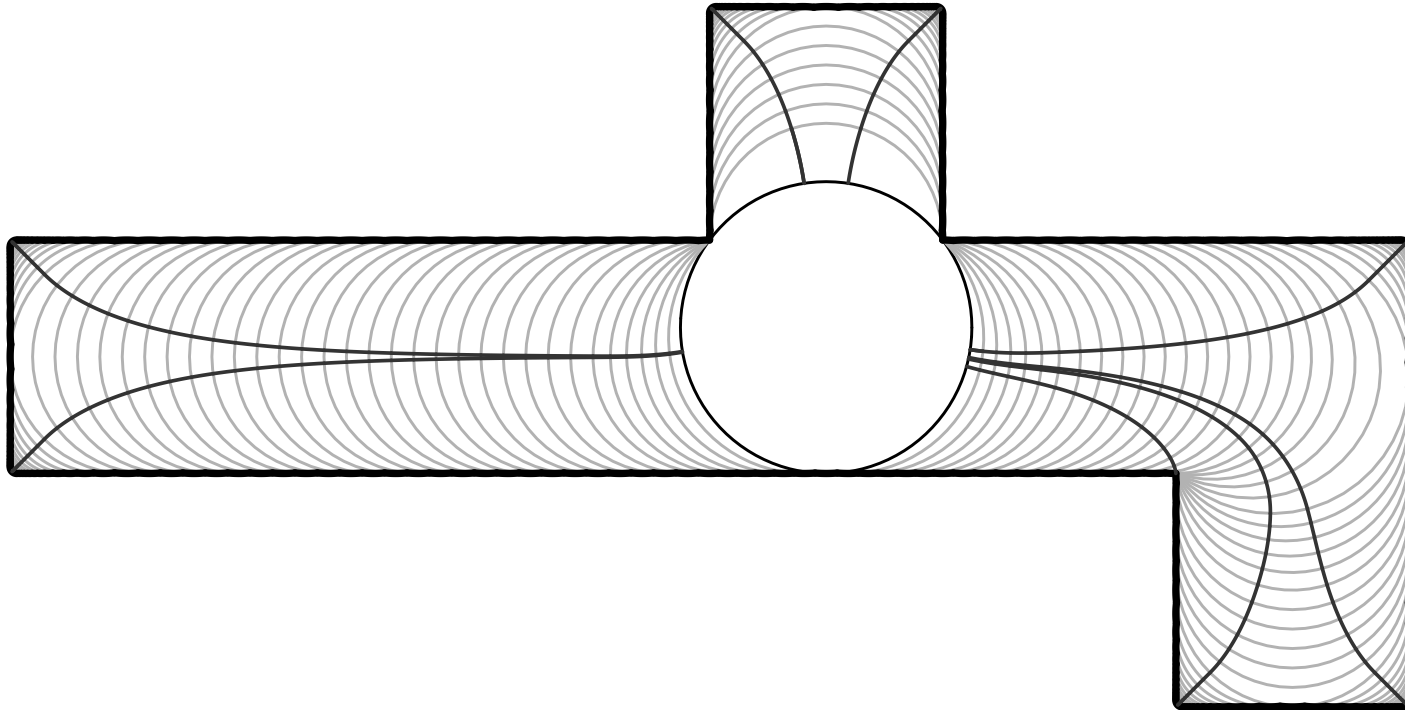

How close is medial axis map to conformal map?

How close is medial axis map to conformal map?

Use “MA-parameters” in Schwarz-Christoffel formula.

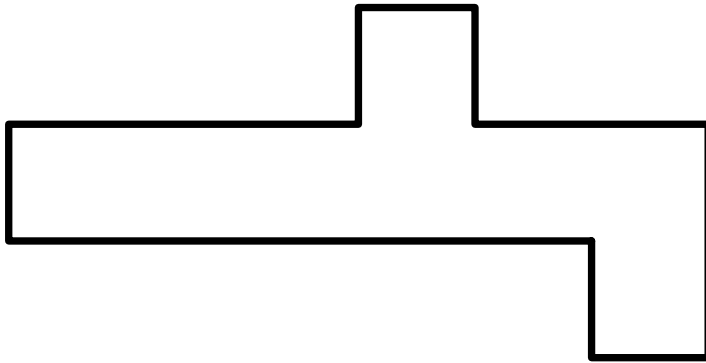

Target Polygon

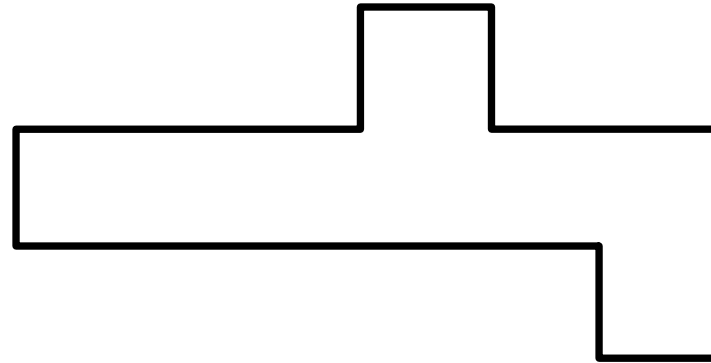

MA Parameters

How close is medial axis map to conformal map?

Use “MA-parameters” in Schwarz-Christoffel formula.

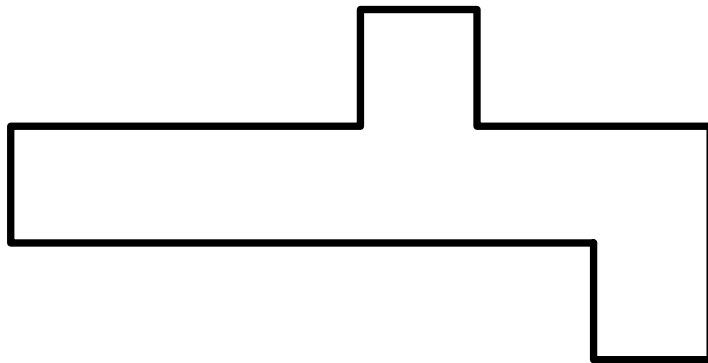

Target Polygon

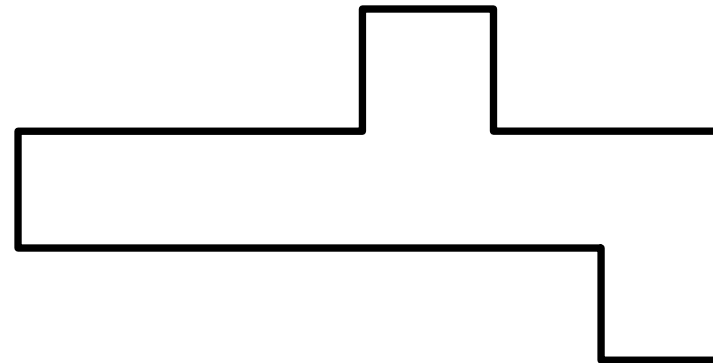

MA Parameters

Looks pretty close. How do we measure error?

How close is medial axis map to conformal map?

Use “MA-parameters” in Schwarz-Christoffel formula.

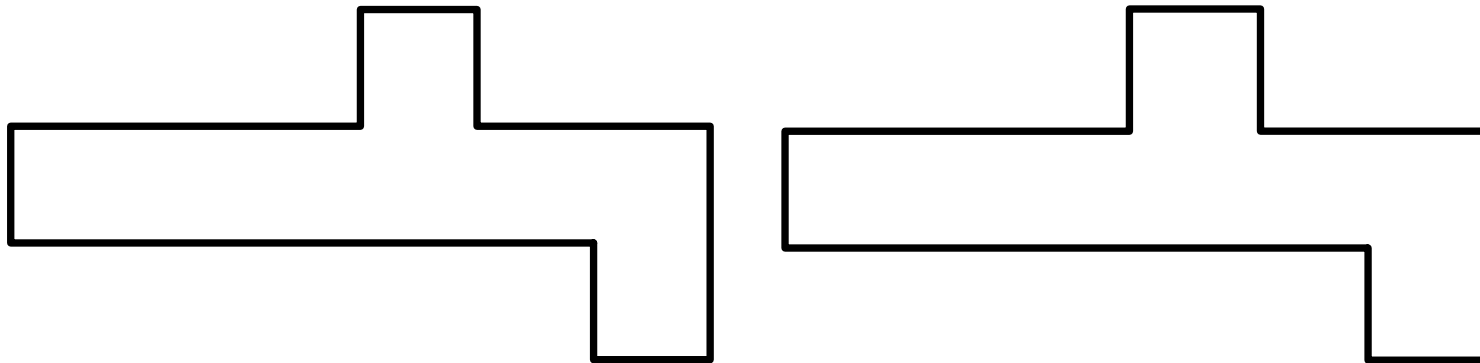

Target Polygon

MA Parameters

Looks pretty close. How do we measure error?

By minimal  $K$ -QC map mapping vertices to vertices.

Any example gives upper bound, e.g., piecewise linear.



## Upper bound for QC-distance:

- Find compatible triangulation
- Compute affine map between triangles
- Take largest  $K$ .

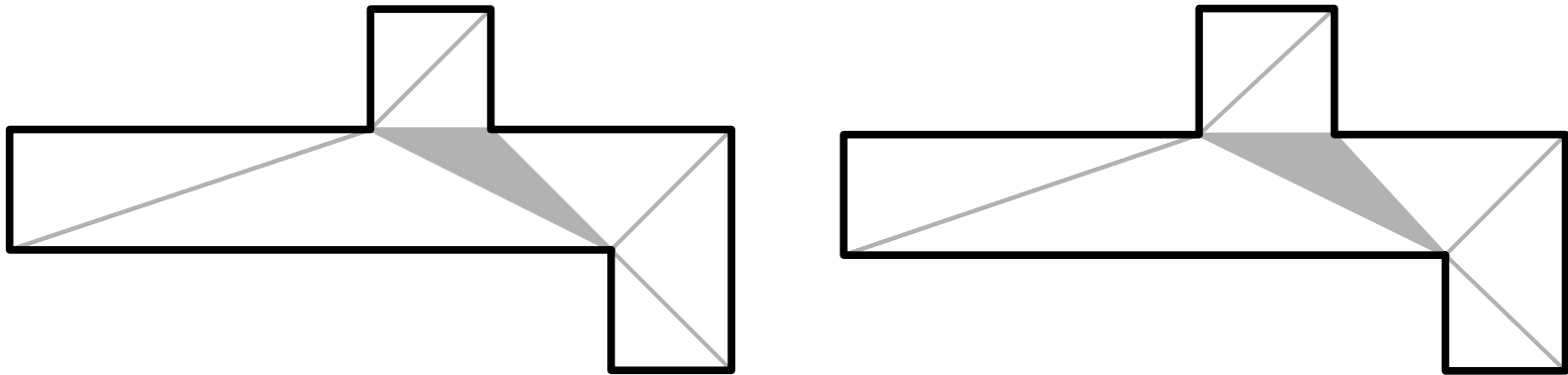

The most distorted triangle is shaded. Here  $K = 1.24$ .

## Upper bound for QC-distance:

- Find compatible triangulation
- Compute affine map between triangles
- Take largest  $K$ .

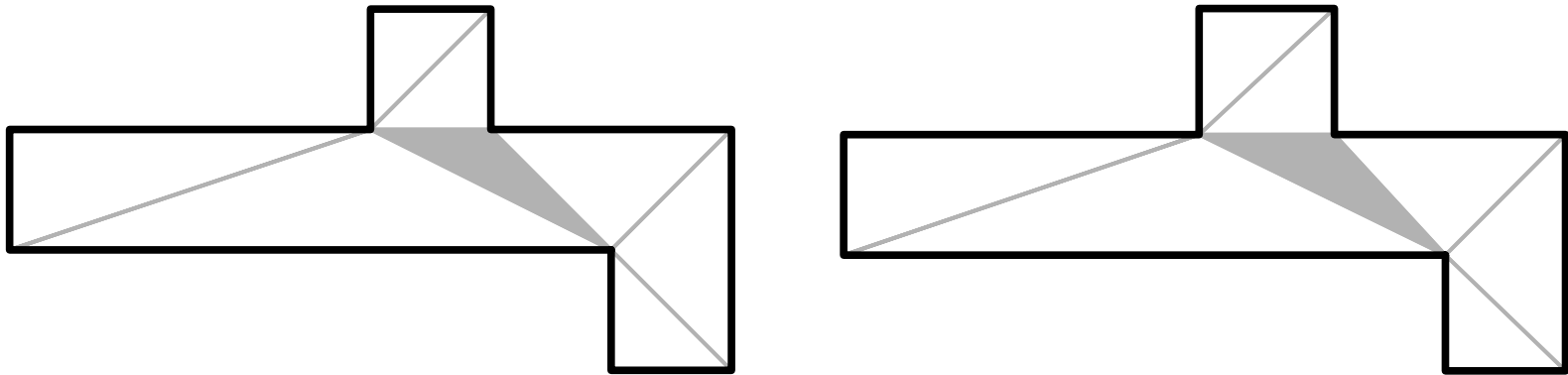

The most distorted triangle is shaded. Here  $K = 1.24$ .

**Bounds QC-error of guessed parameters without needing to know the true SC-parameters.**

**Theorem:** Medial axis map gives QC-error  $< 8$ .

**Theorem:** Medial axis map gives QC-error  $< 8$ .

Why is this theorem true?

**Theorem:** Medial axis map gives QC-error  $< 8$ .

Why is this theorem true?

**Short answer:** hyperbolic 3-manifold theory

**Theorem:** Medial axis map gives QC-error  $< 8$ .

Why is this theorem true?

**Longer answer:** because MA-map has conformal extension to different region with same boundary.

**Theorem:** Medial axis map gives QC-error  $< 8$ .

Why is this theorem true?

**Longer answer:** because MA-map has conformal extension to different region with same boundary.

- Other region is a surface in upper 3-space.
- The surface can be mapped conformally to disk.
- Medial axis map = boundary values of this map.

The **dome** of a domain is upper envelope of all hemispheres whose base disk is in  $\Omega$ .

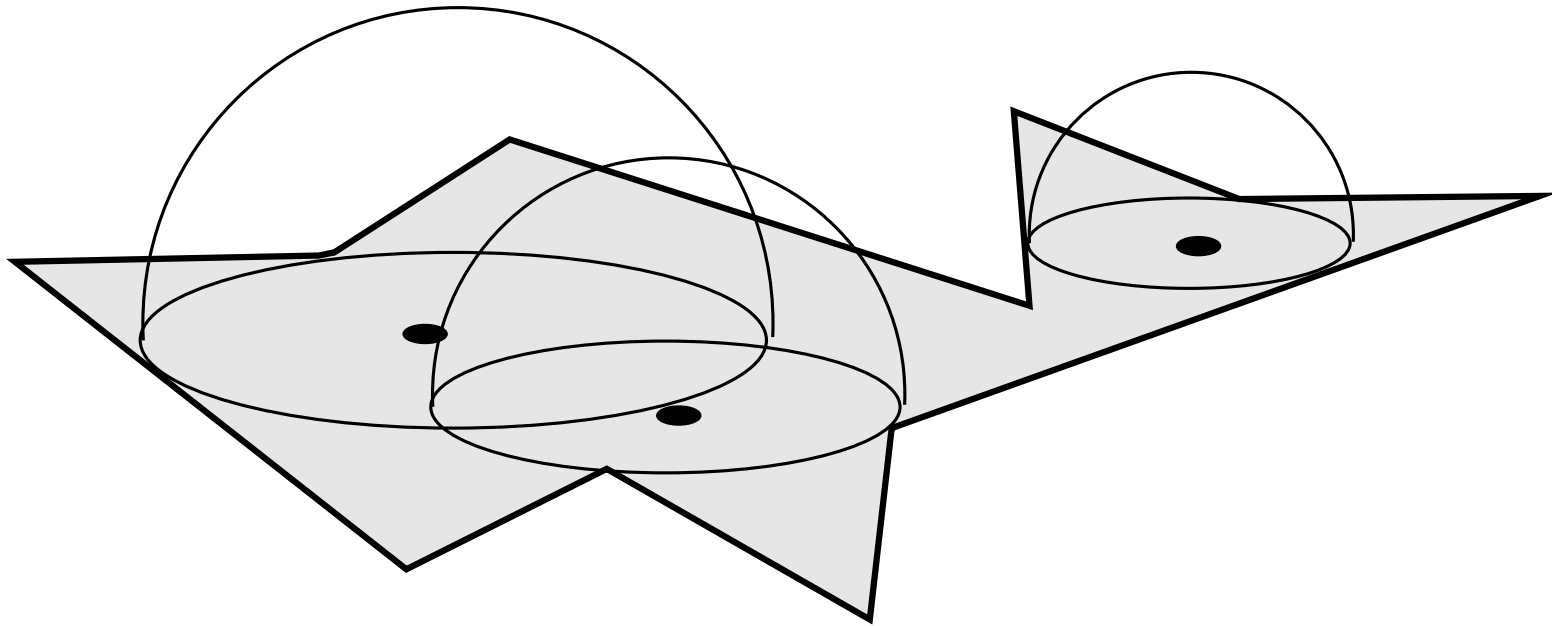

Suffices to take medial axis disks (= maximal disks).



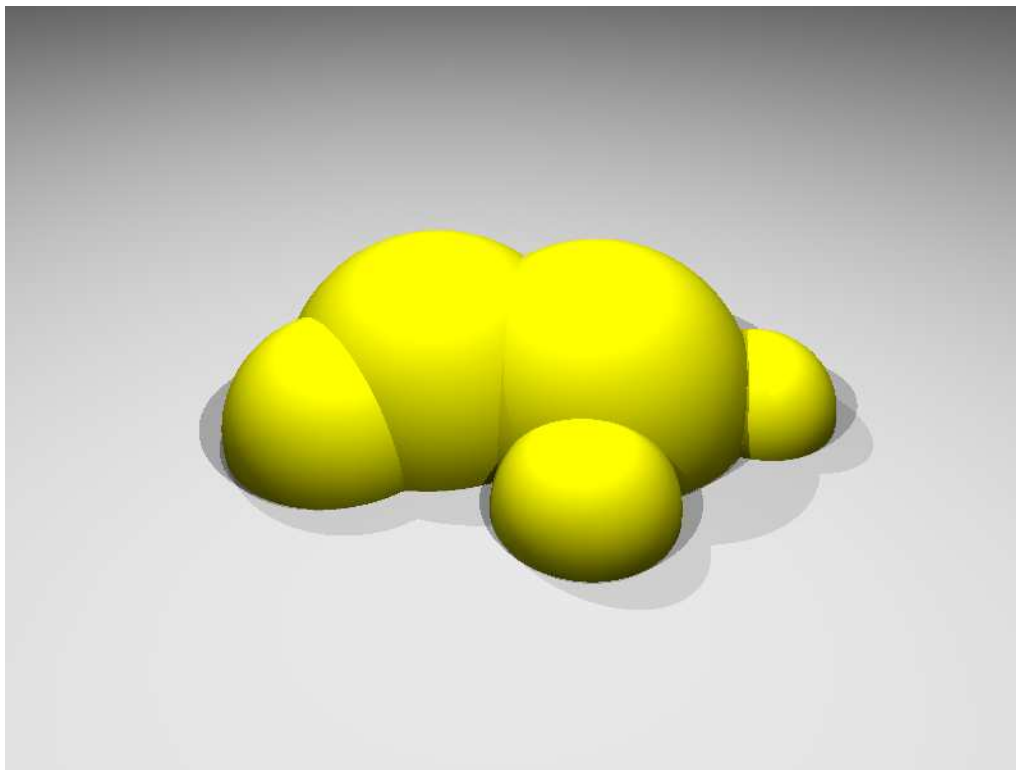
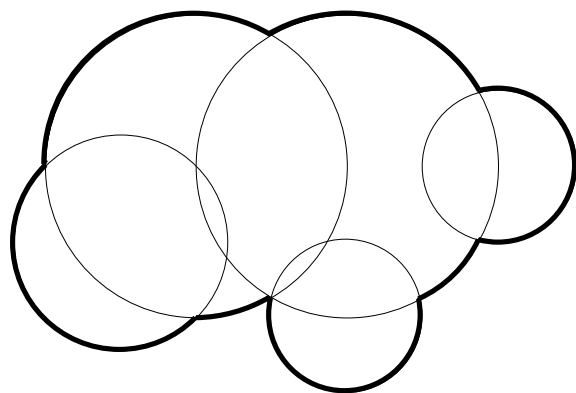

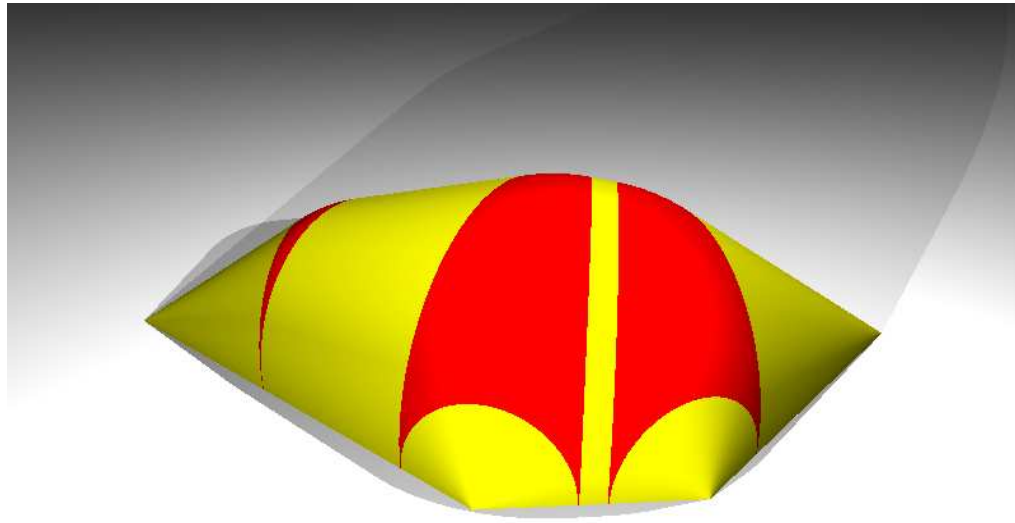
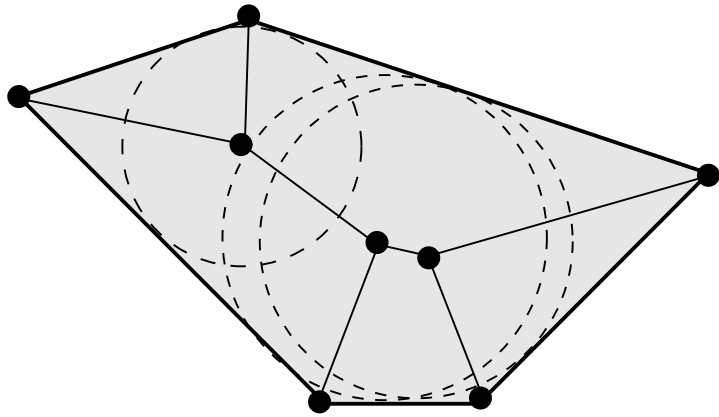

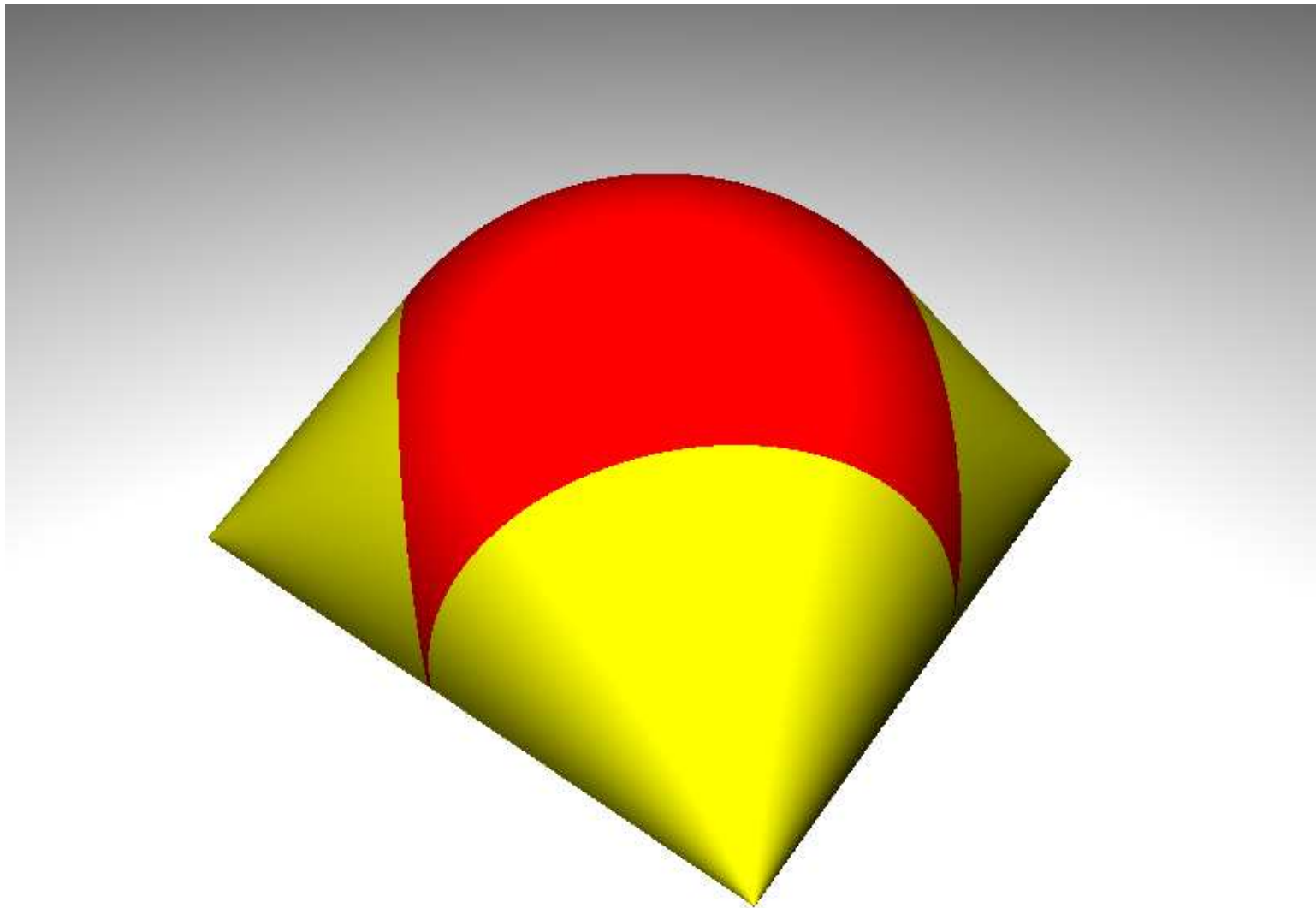

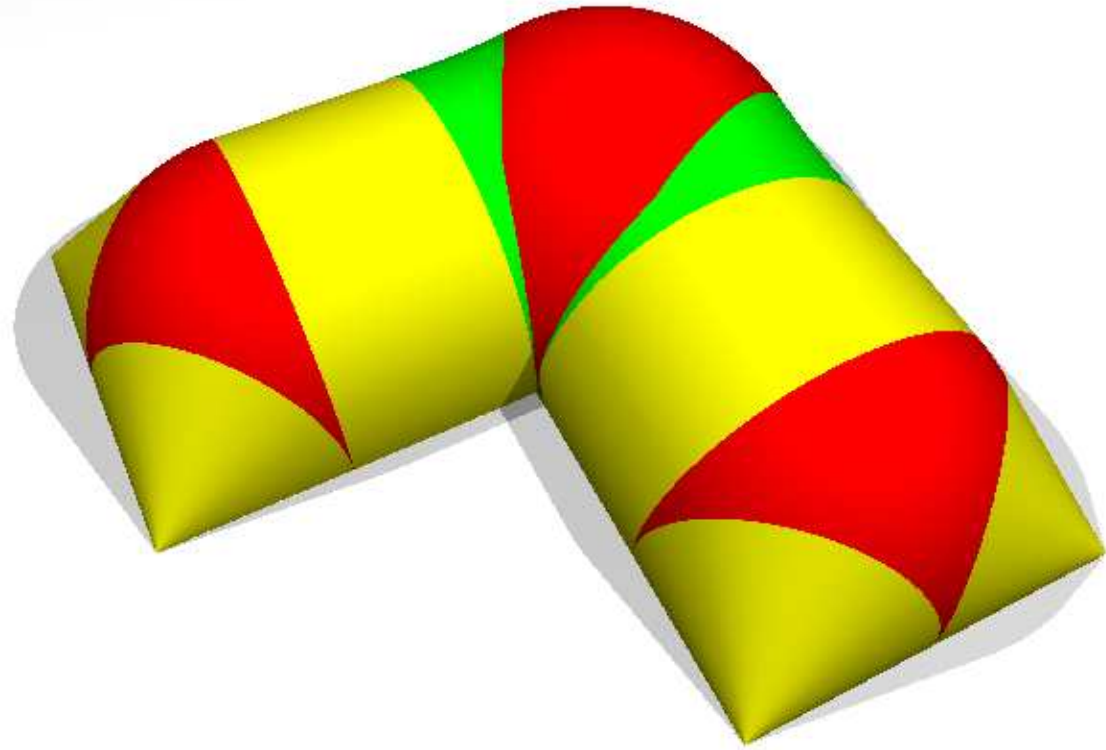

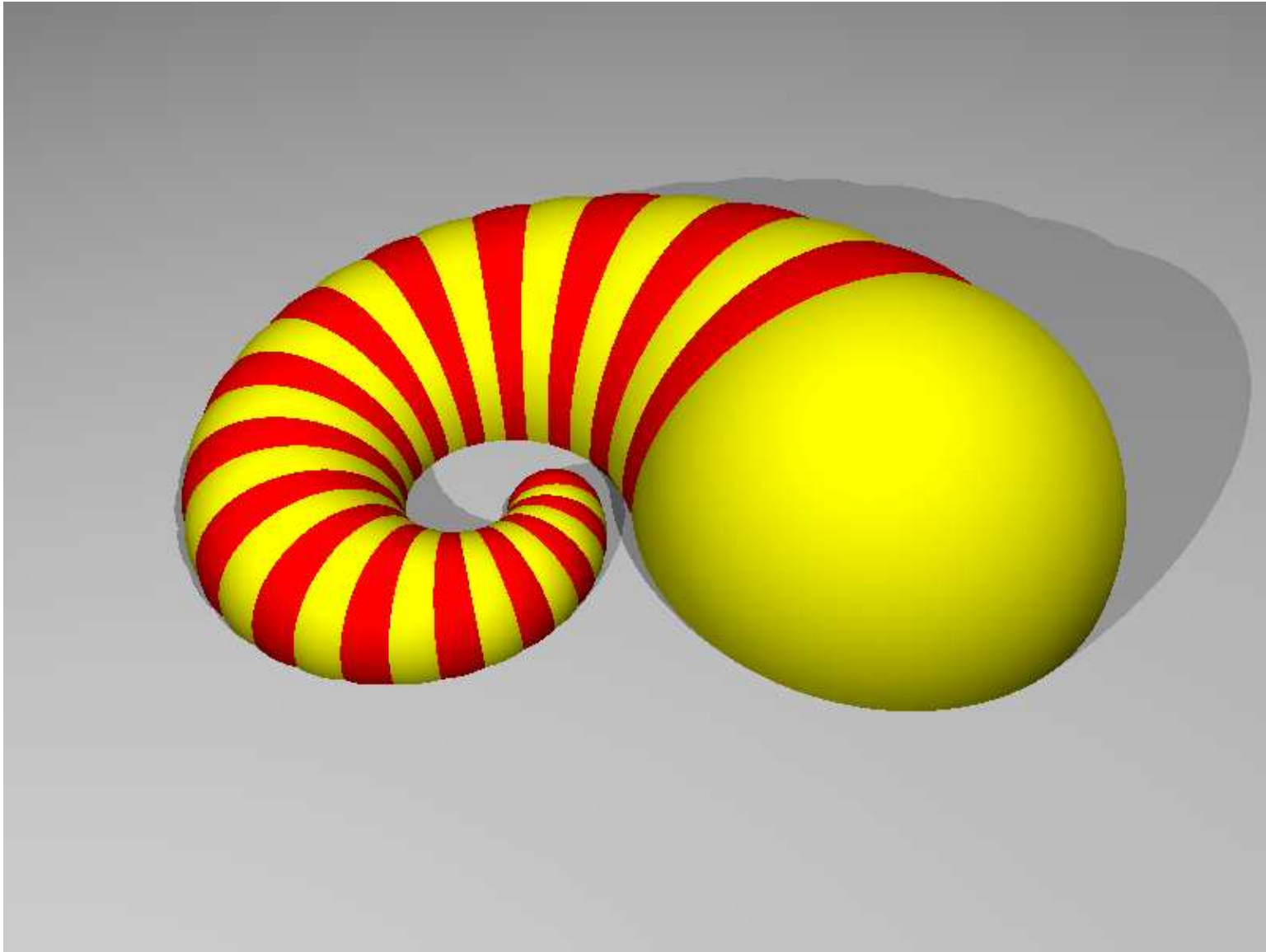

Every dome has conformal map to disk by “flattening”.

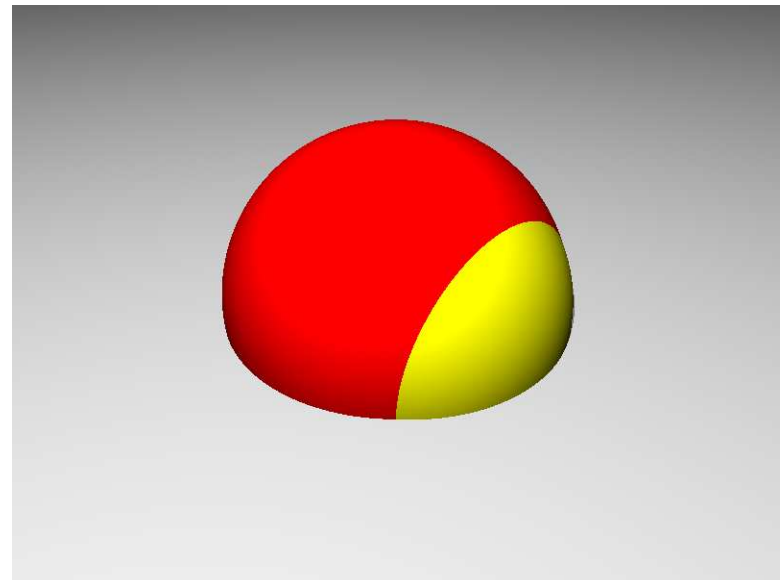
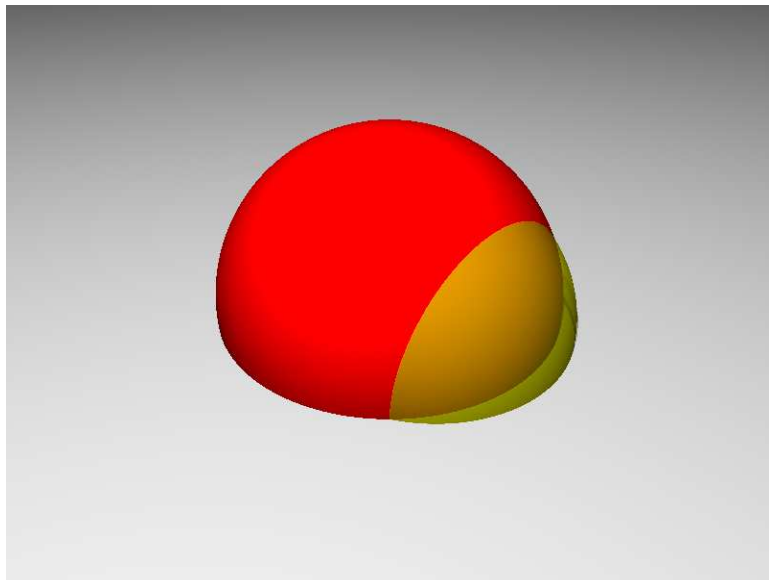
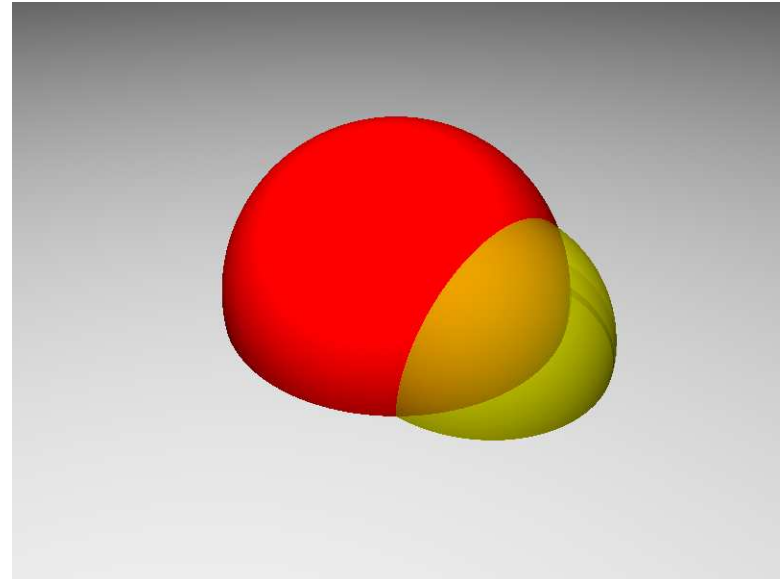
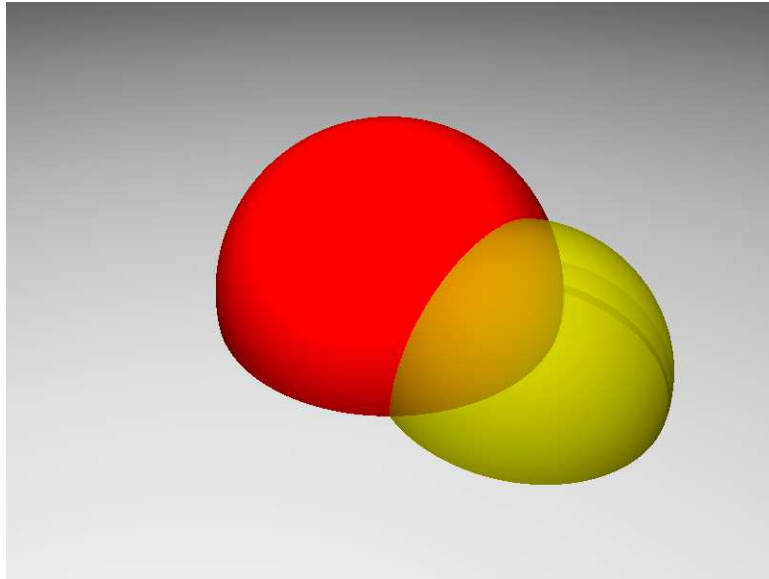

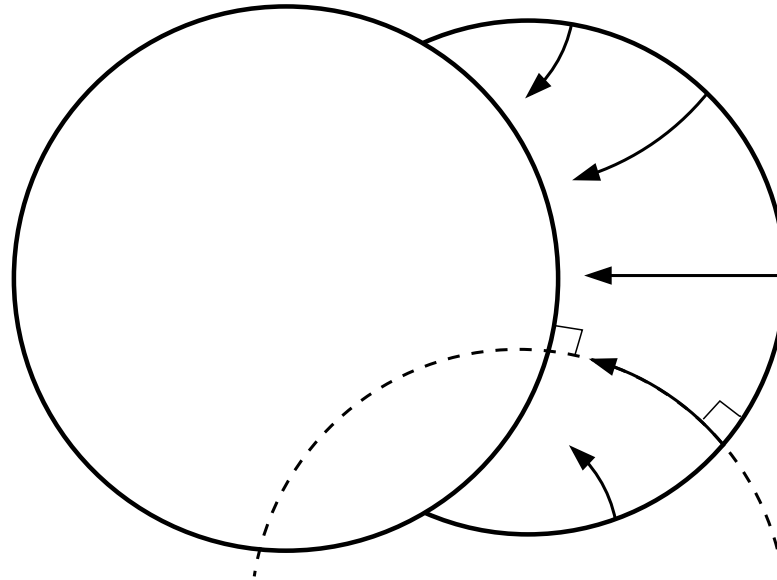

Medial axis map = boundary of flattening map (iota)

= boundary of conformal map of dome to hemisphere

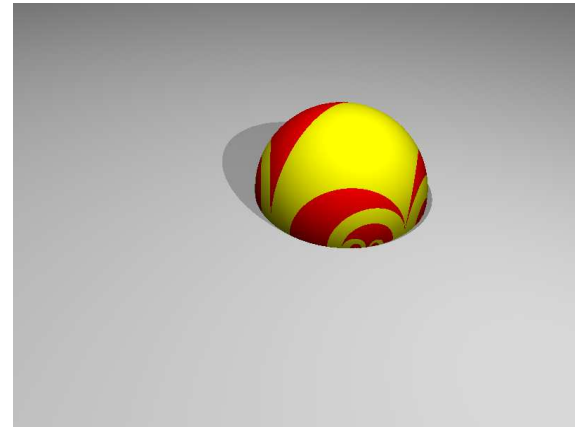
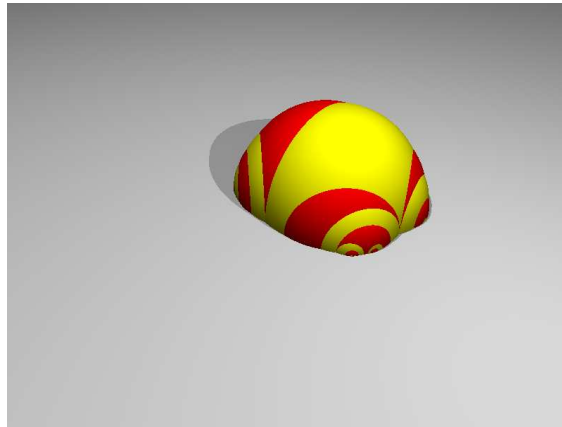
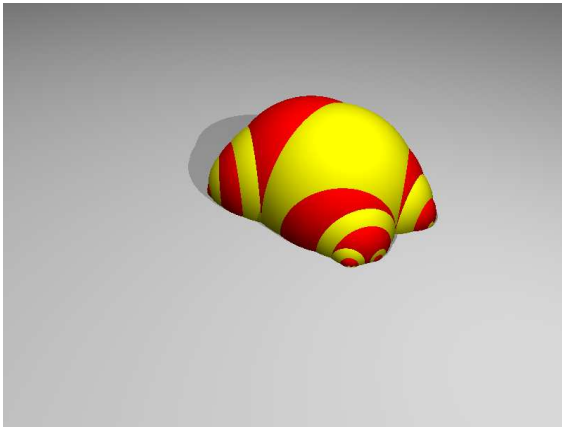
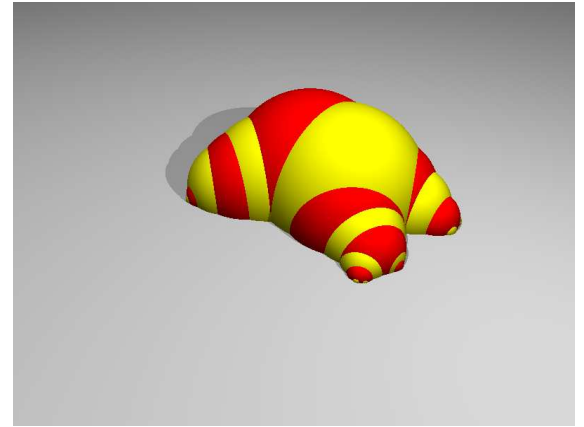
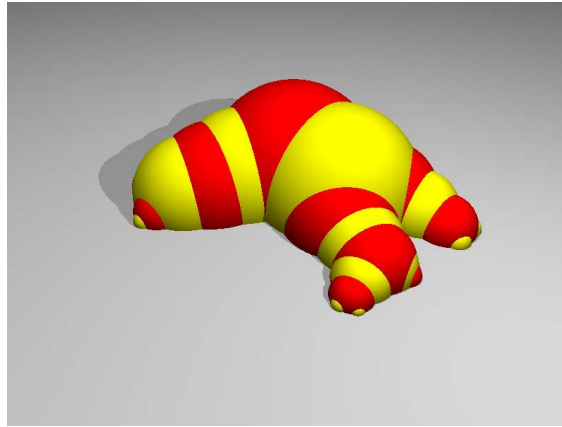
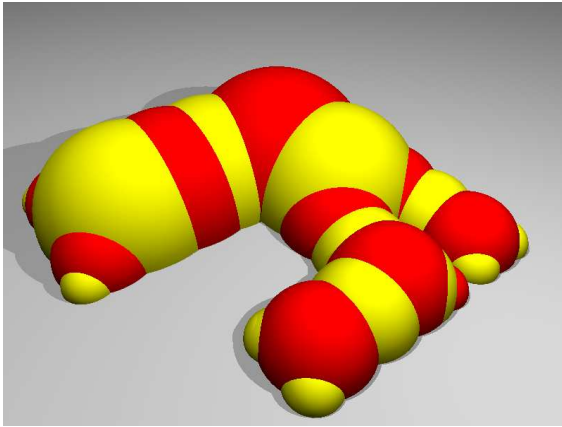

Map dome to hemisphere by making sides flush.



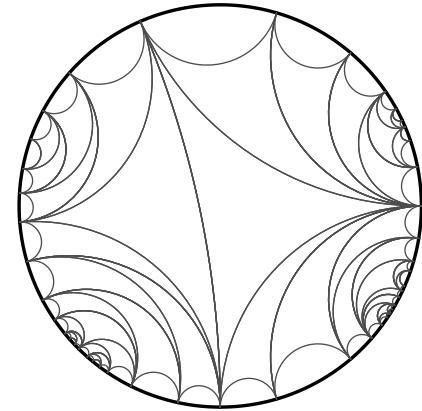
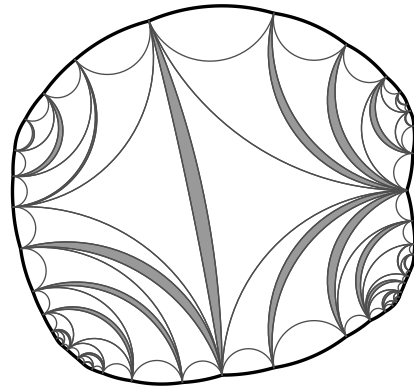
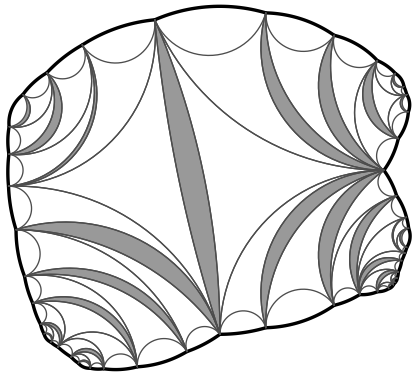
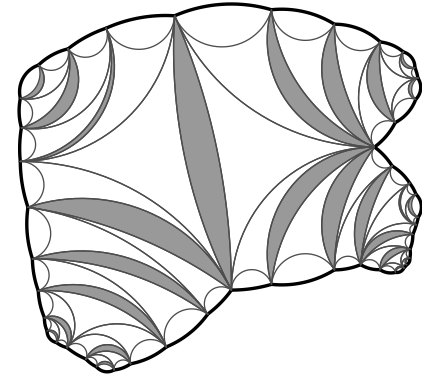
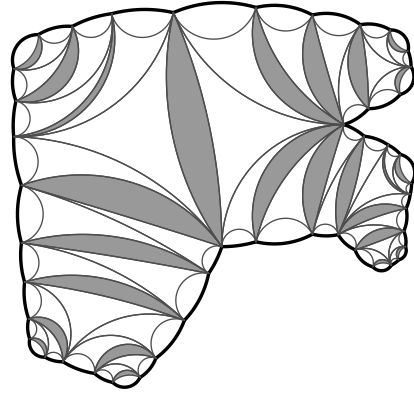
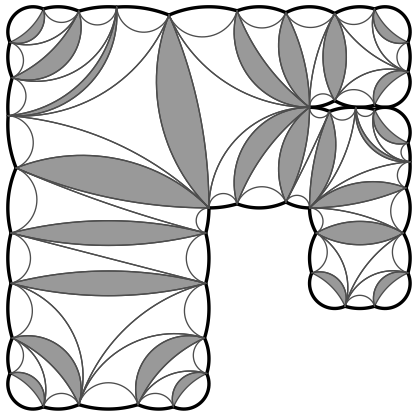

Planar version of previous figure.

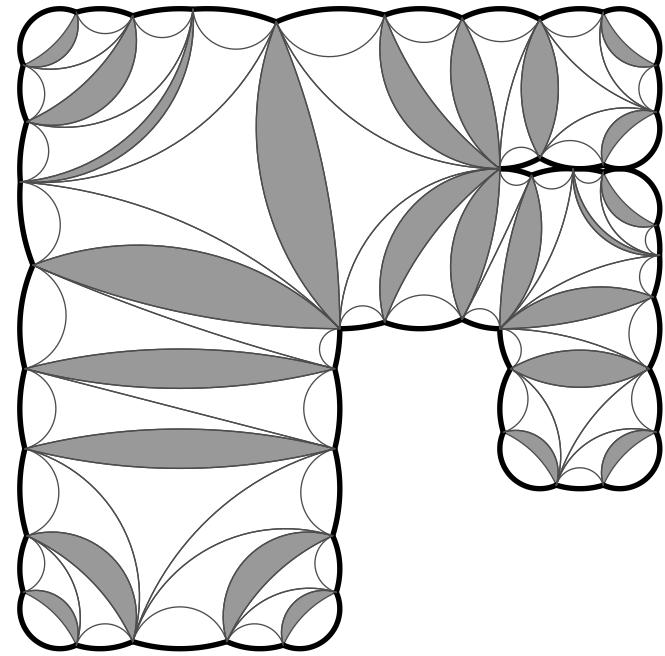
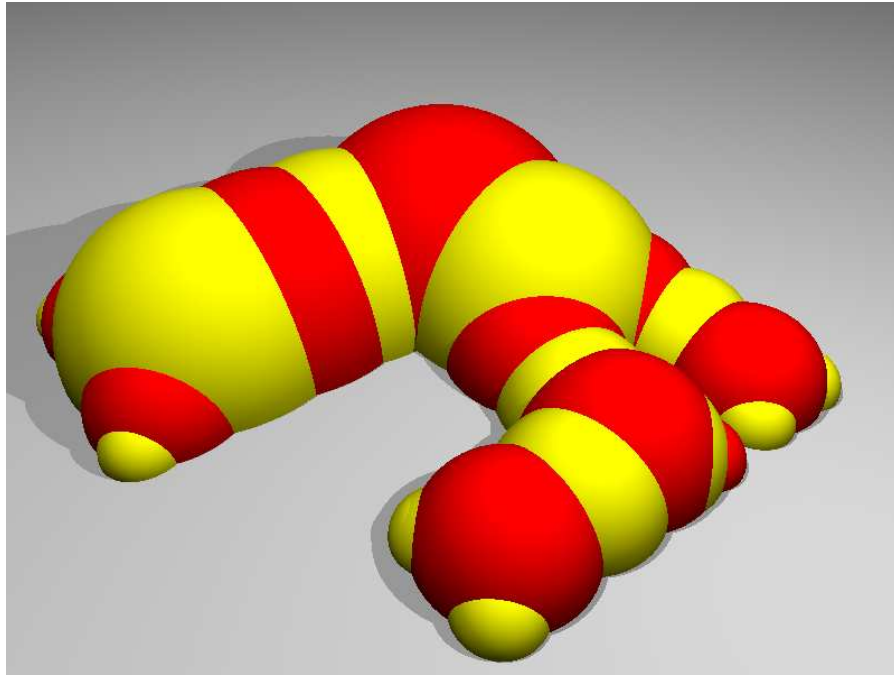

How are these connected?

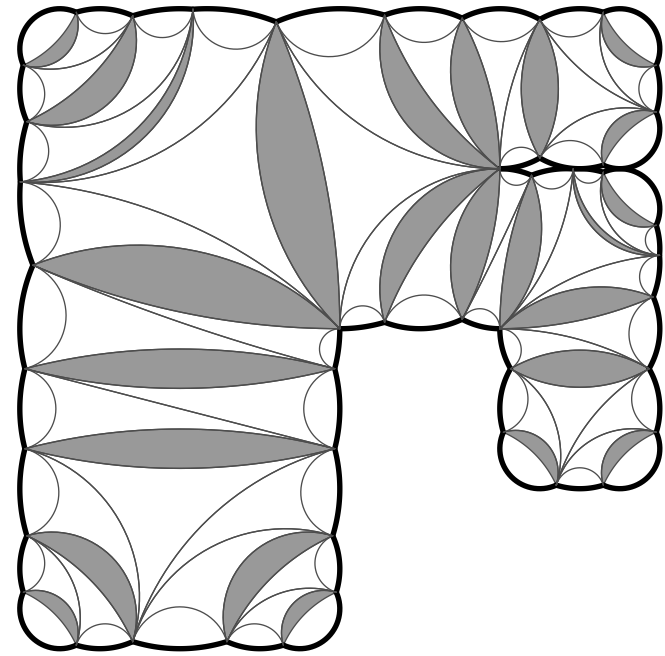
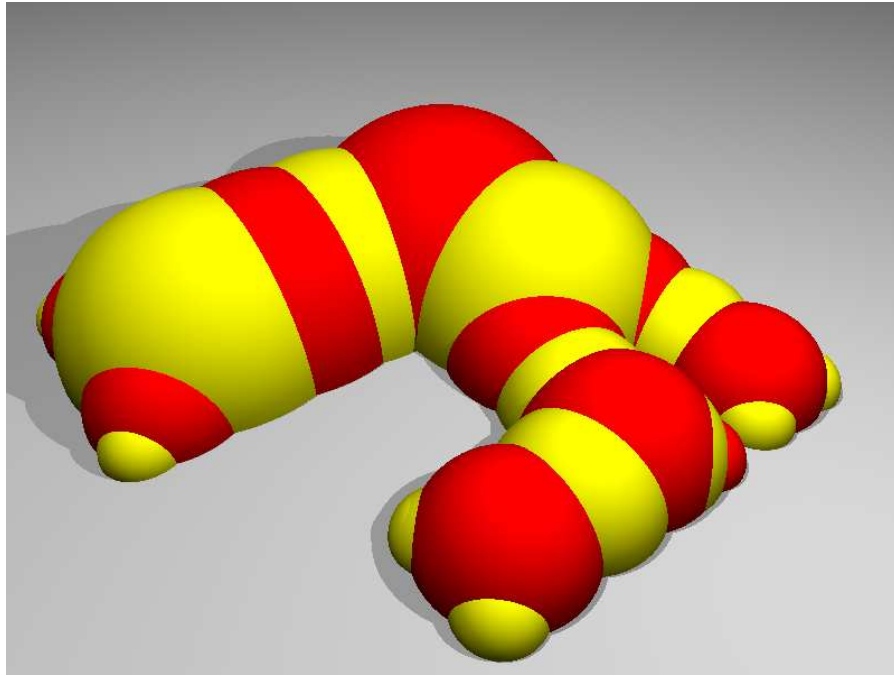

How are these connected? By projection.

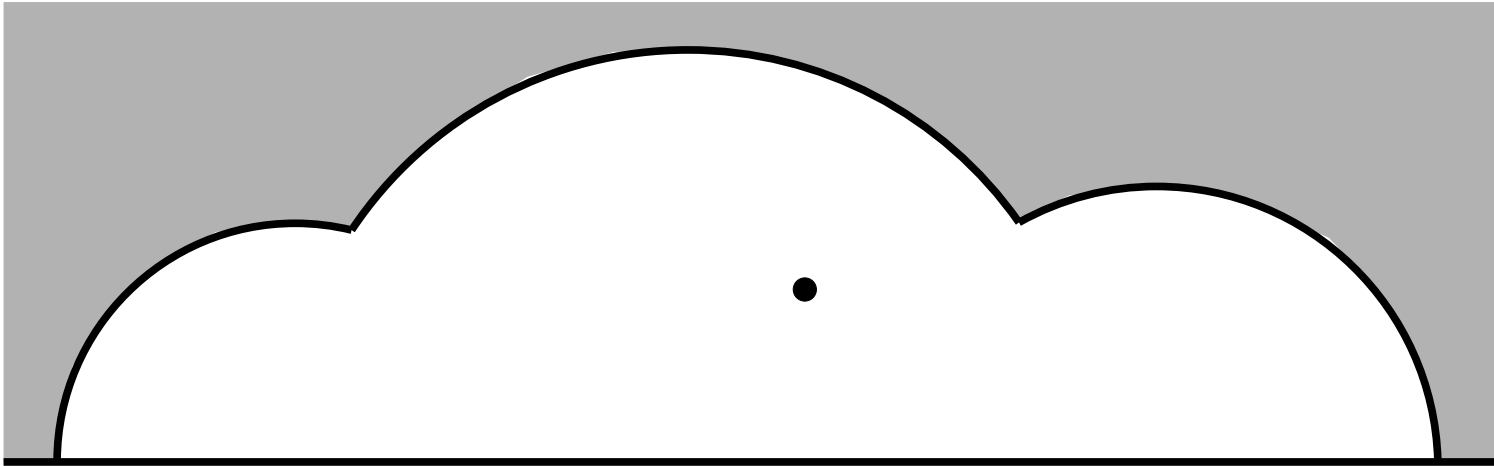

Region below dome is union of hemispheres

Hemispheres = hyperbolic half-spaces.

Region above dome is hyperbolically convex.

Consider nearest point retraction onto this convex set.

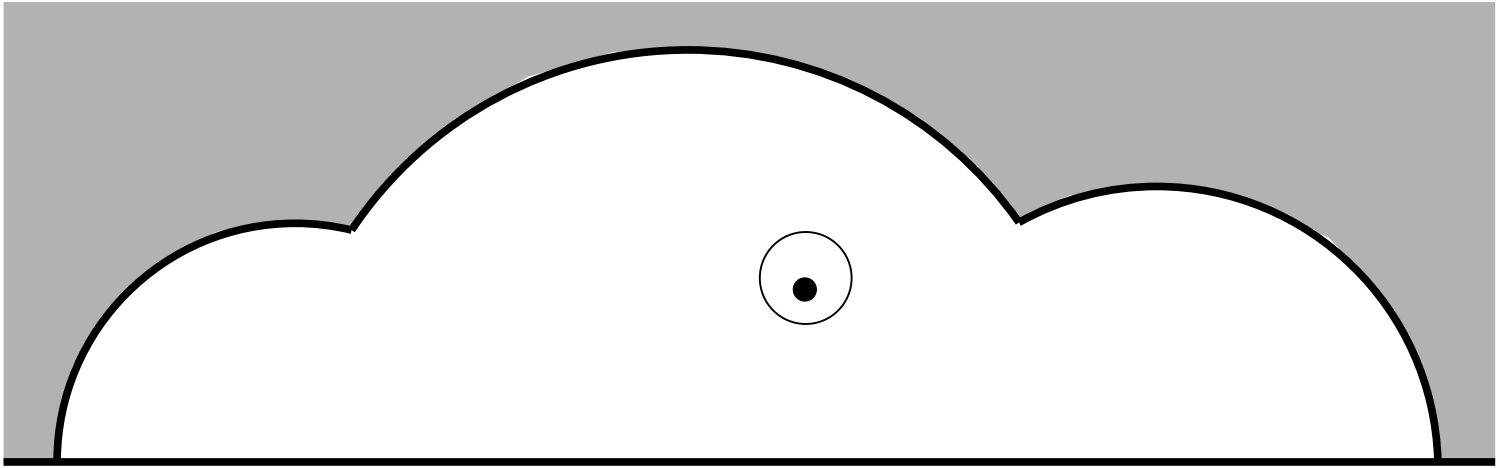

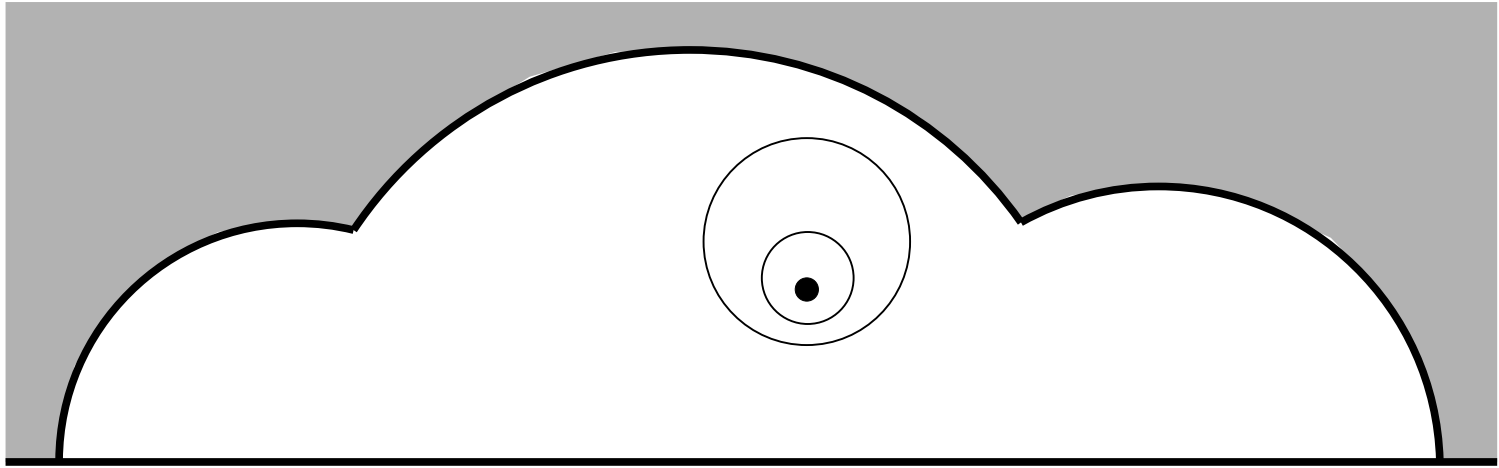

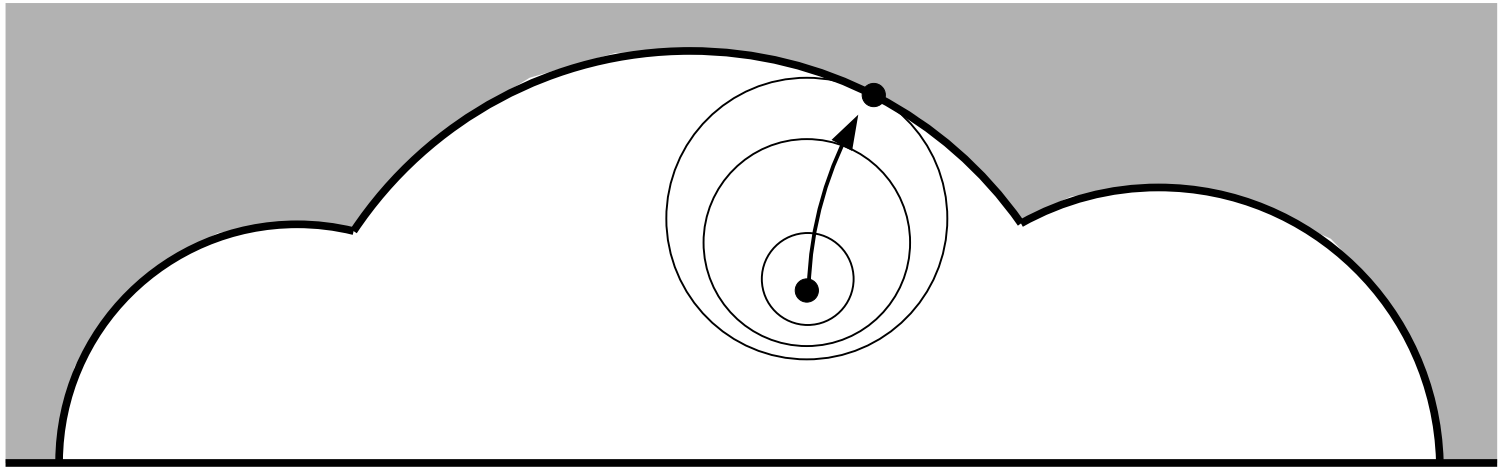

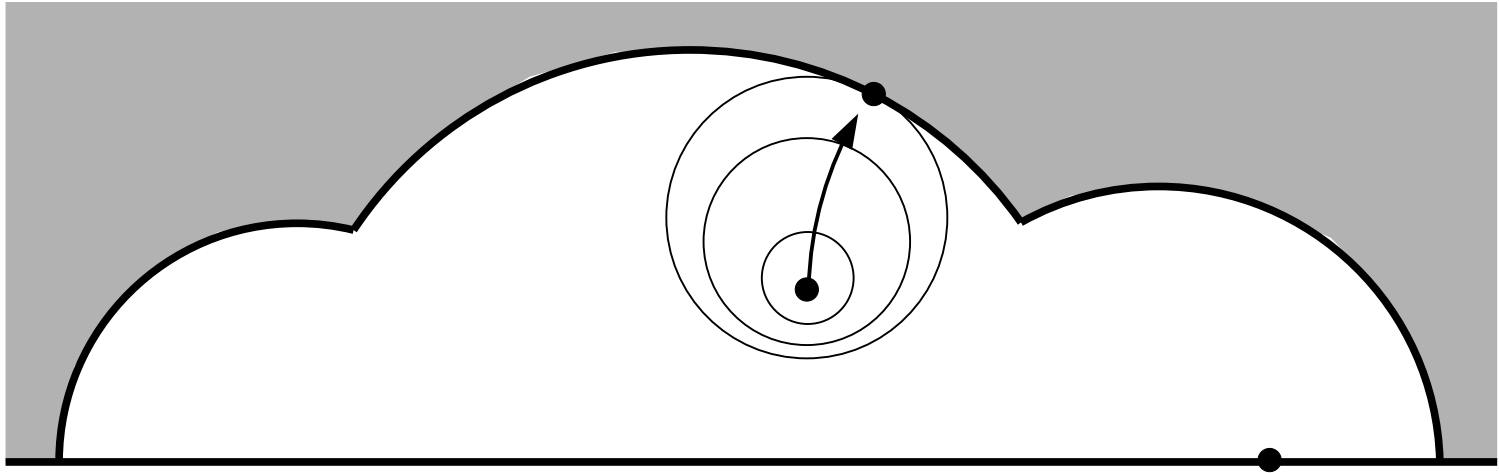



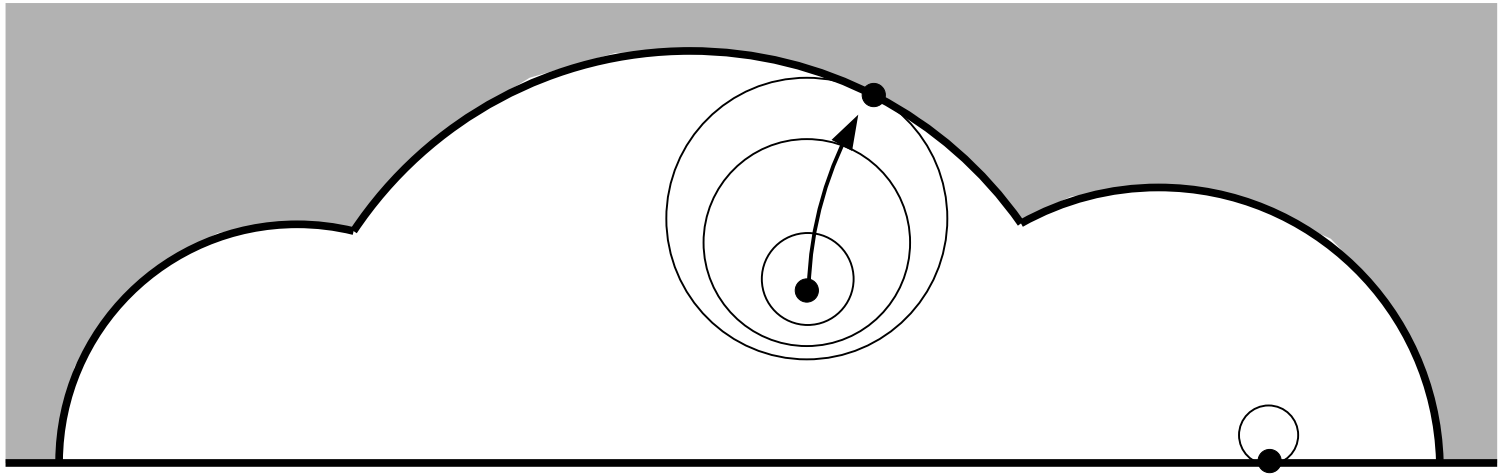

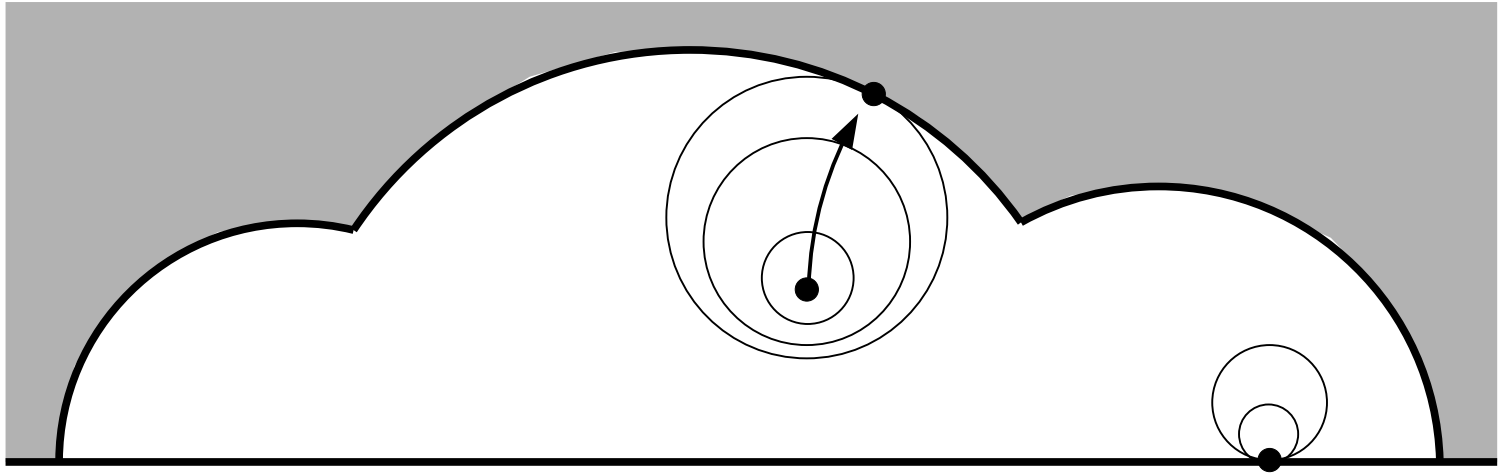

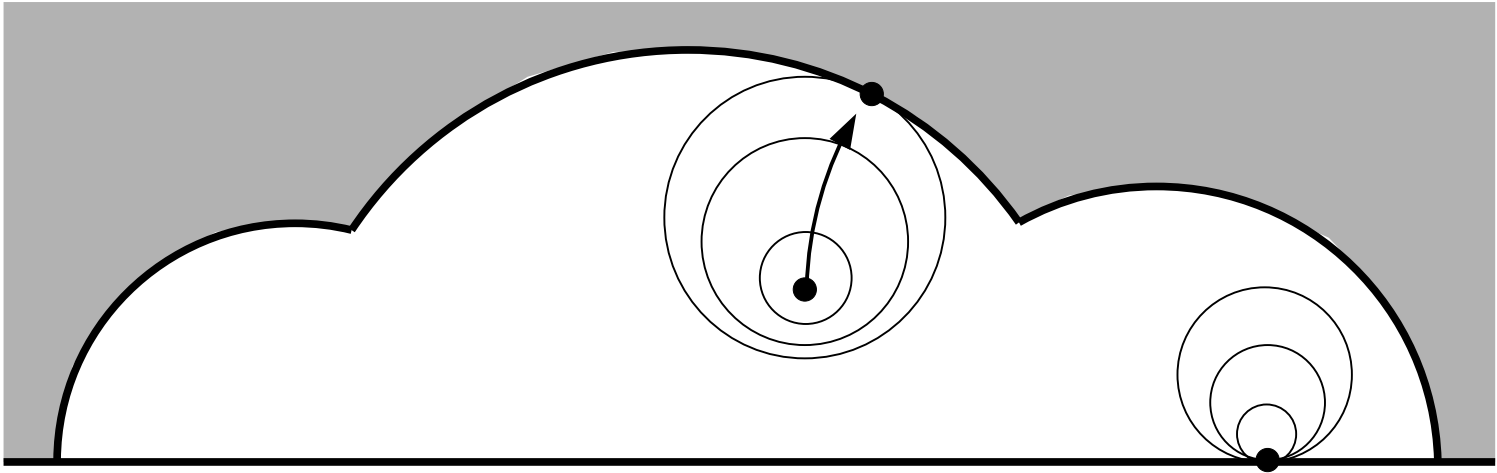

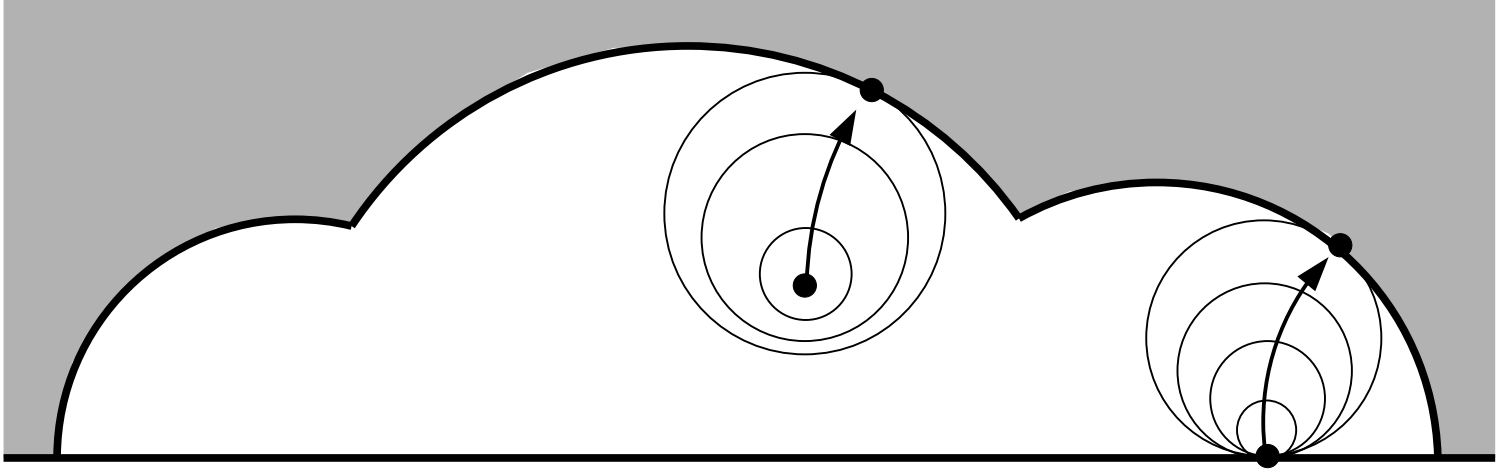

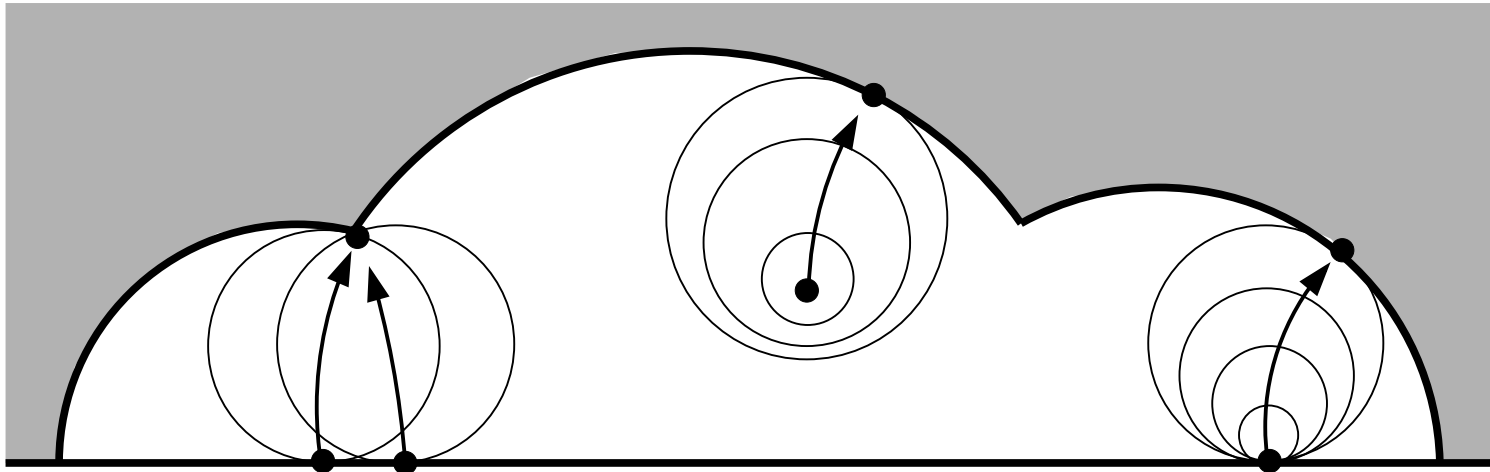

Need not be a homeomorphism, but ...

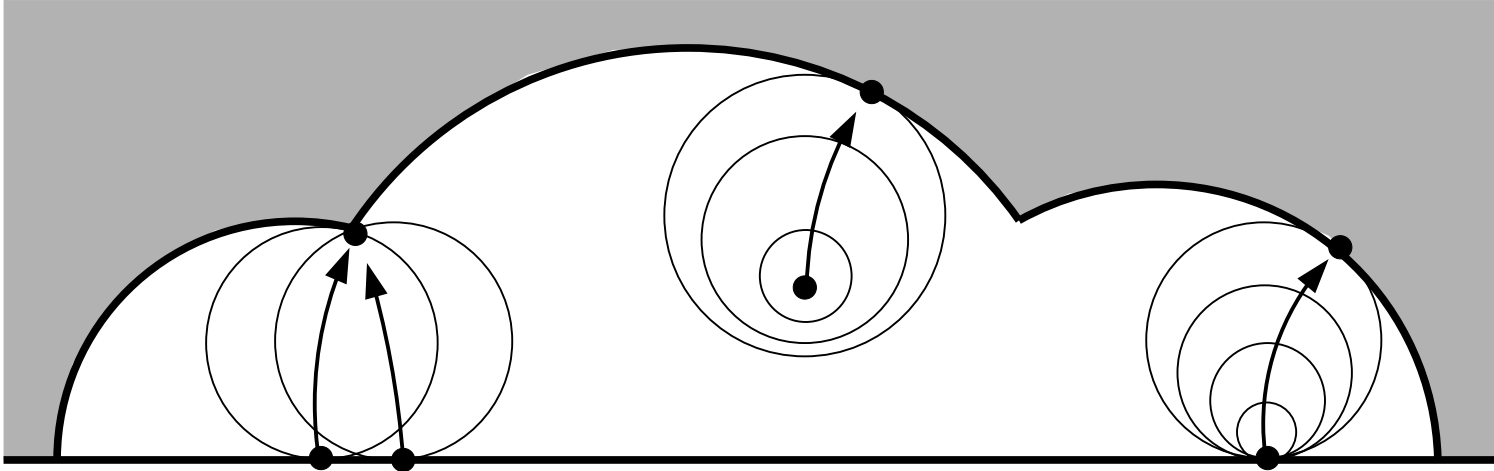

Need not be a homeomorphism, but it is a **quasi-isometry**

$$\frac{1}{A} \leq \frac{\rho(R(x), R(y))}{\rho(x, y)} \leq A, \quad \text{if } \rho(x, y) \geq B.$$

i.e.,  $R$  is bi-Lipschitz on large scales.

Metrics are hyperbolic metrics on  $\Omega$  and  $S$ .

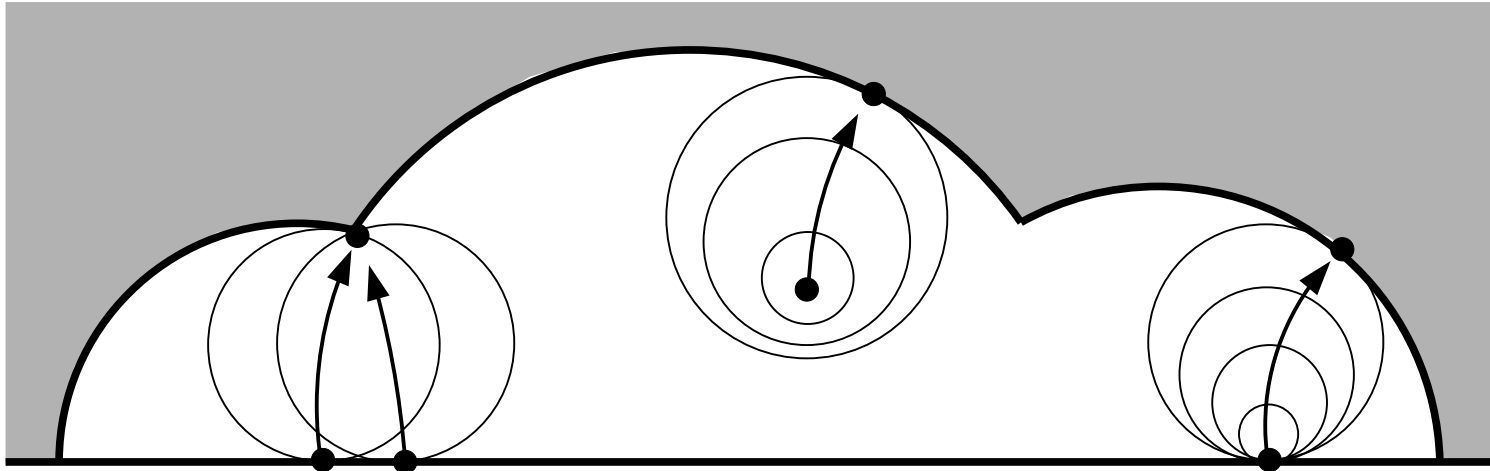

“Smoothing” gives  $K$ -QC map fixing boundary points.

Sullivan’s theorem:  $K$  is independent of domain.

Dennis Sullivan, David Epstein and Al Marden, C.B.

Best value unknown,  $2.1 < K < 7.82$ .



Dennis Sullivan



David Epstein



Al Marden



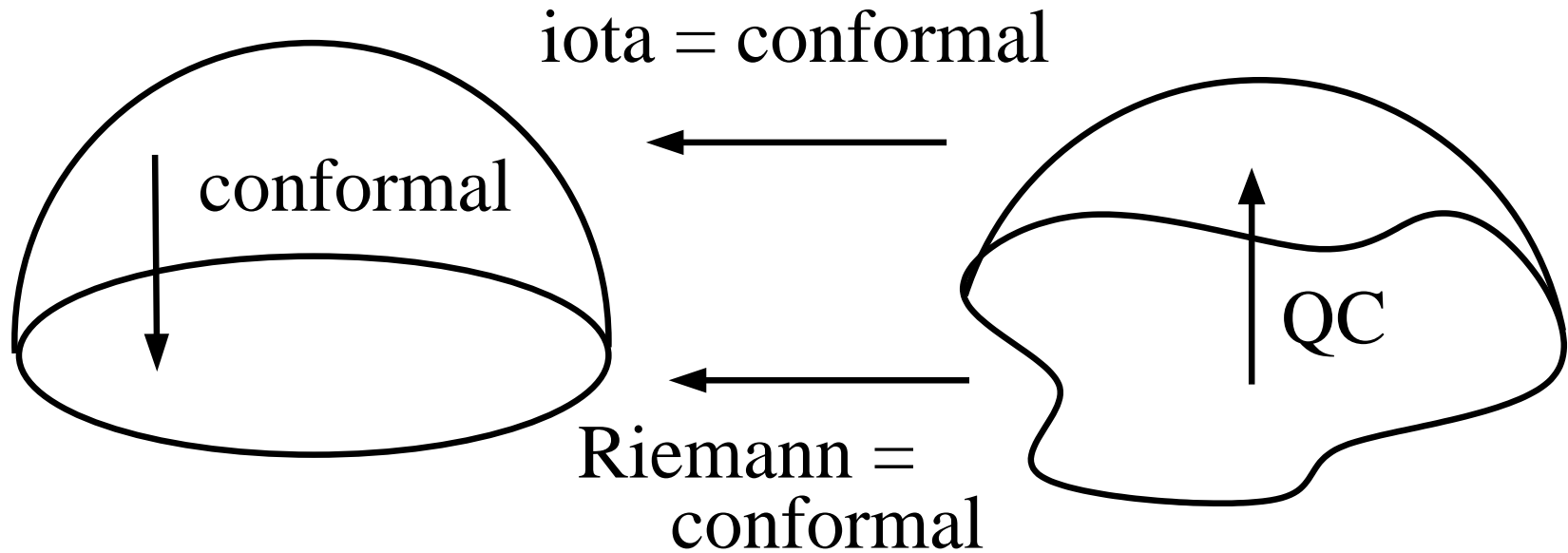

Iota = conformal from dome to disk.

Medial axis flow = boundary values of iota

Riemann map = conformal from base to disk

Sullivan's thm  $\Rightarrow$  MA-map has  $K$ -QC extension

Crescents in base can map to geodesics on surface.

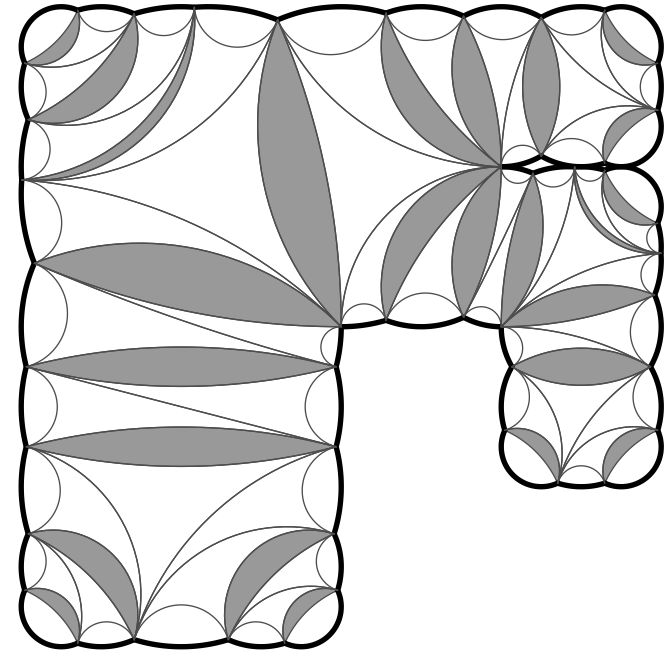
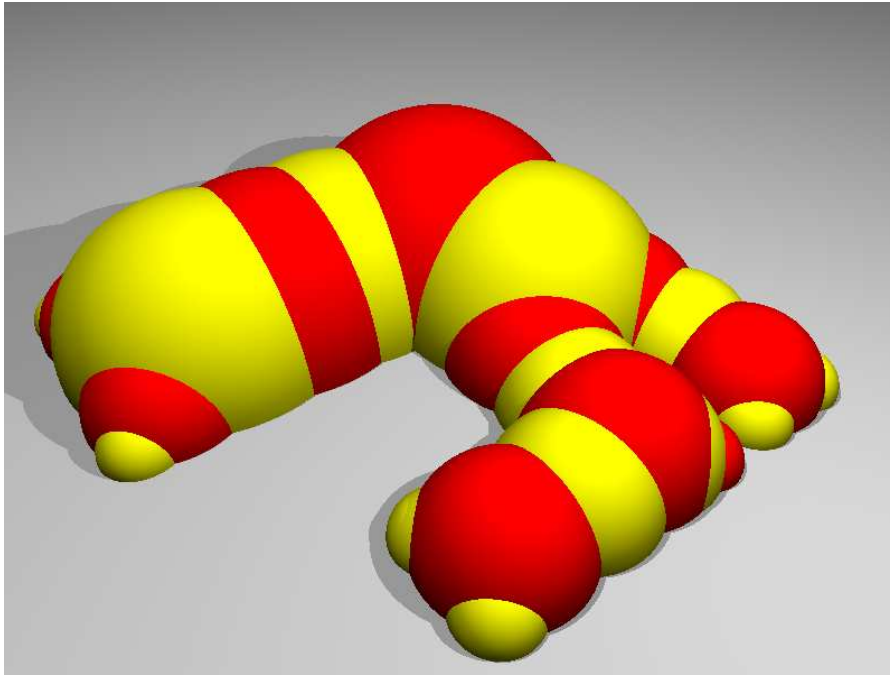

Gray collapses to bending lines, “width = angle”.

White maps isometrically to dome.

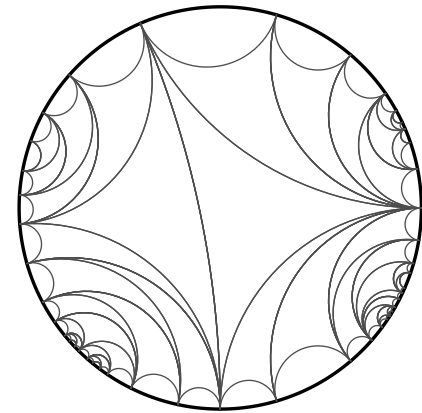
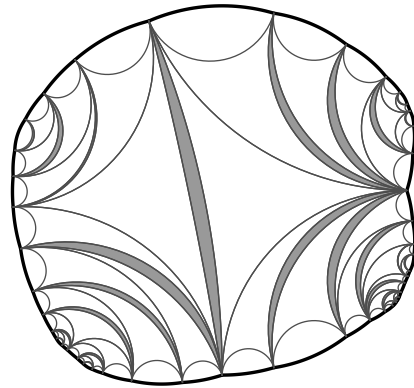
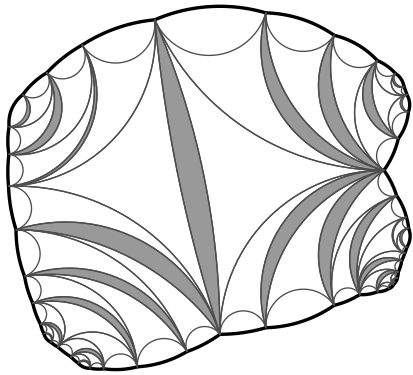
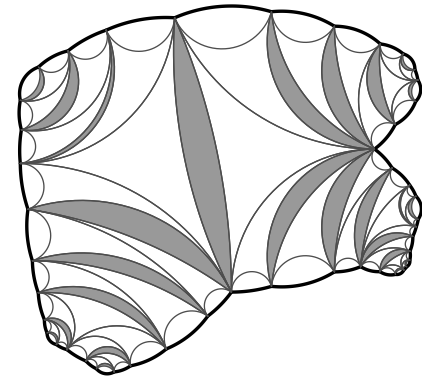
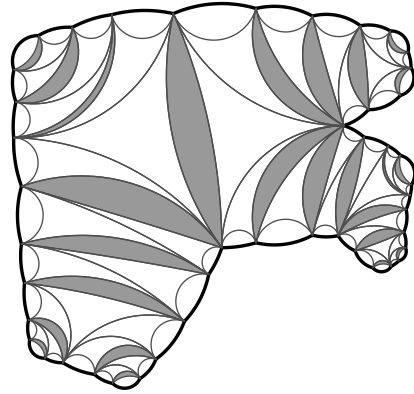
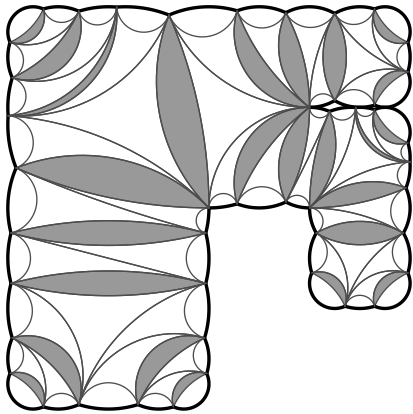

Angle scaling family - crescent angles decrease

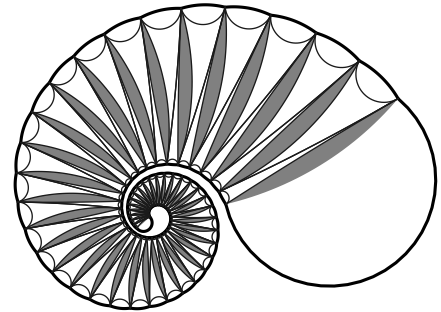
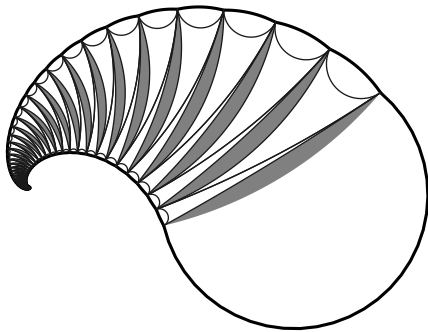
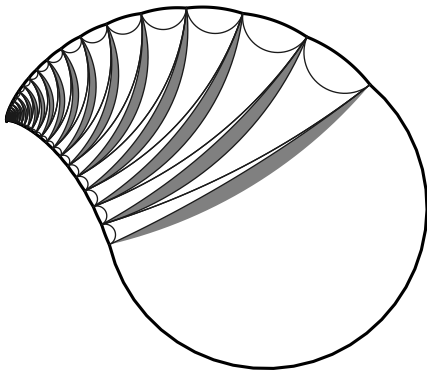
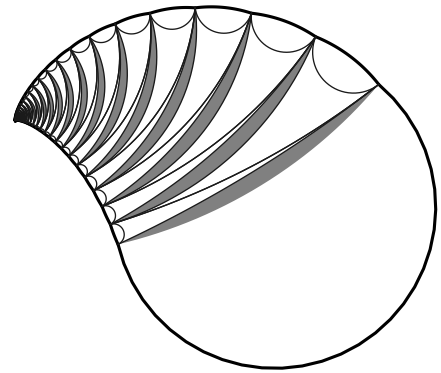
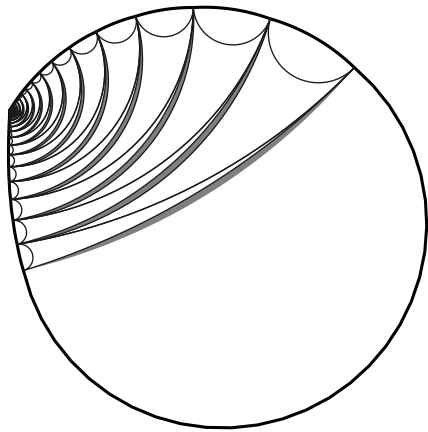
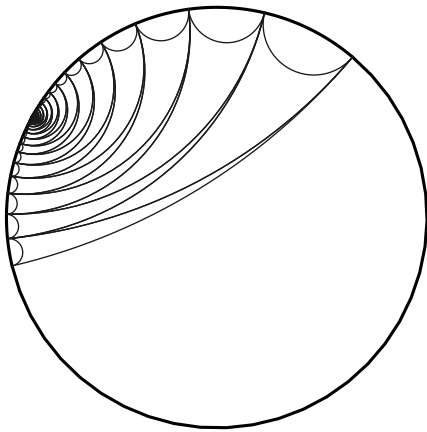

# Application to computational geometry: Quadrilateral meshes

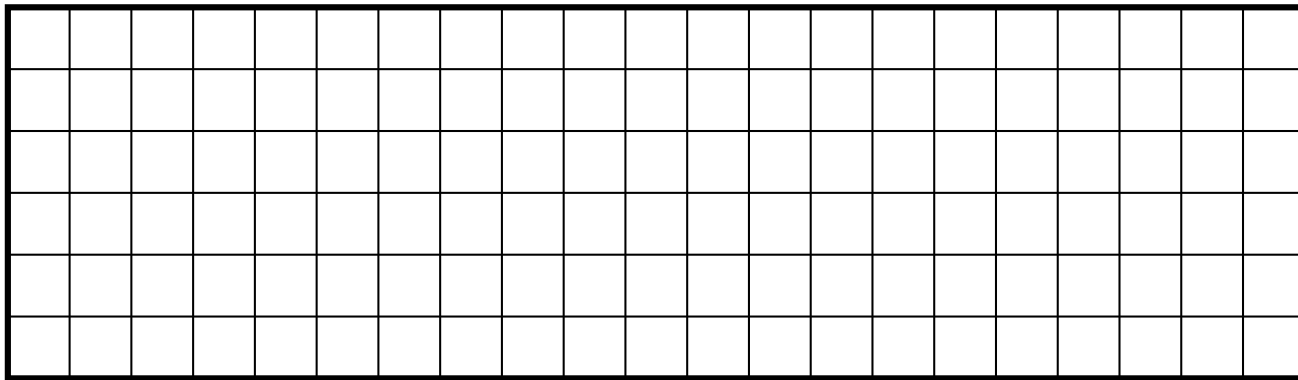
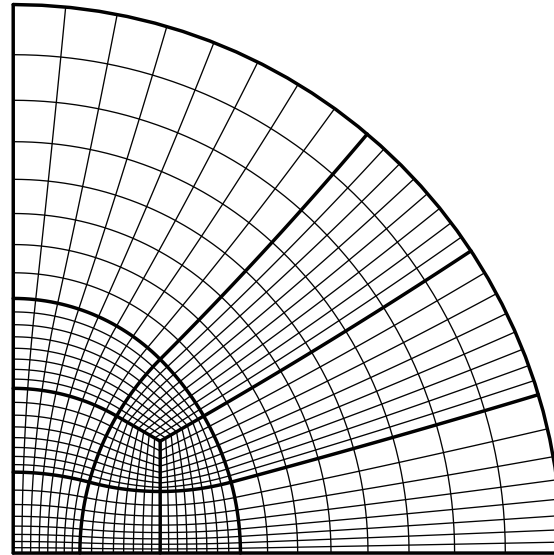
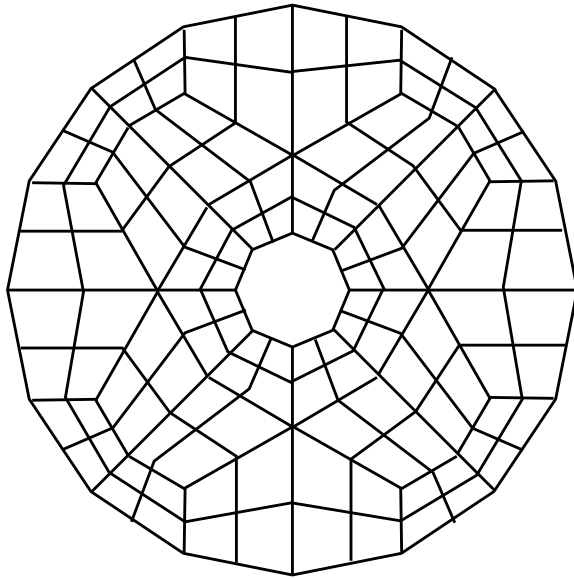

Marshall Bern and David Eppstein, 2000.

- $n$ -gons have  $O(n)$  quad mesh with angles  $\leq 120^\circ$ .
- $O(n \log n)$  work.
- Regular hexagon shows  $120^\circ$  is sharp.

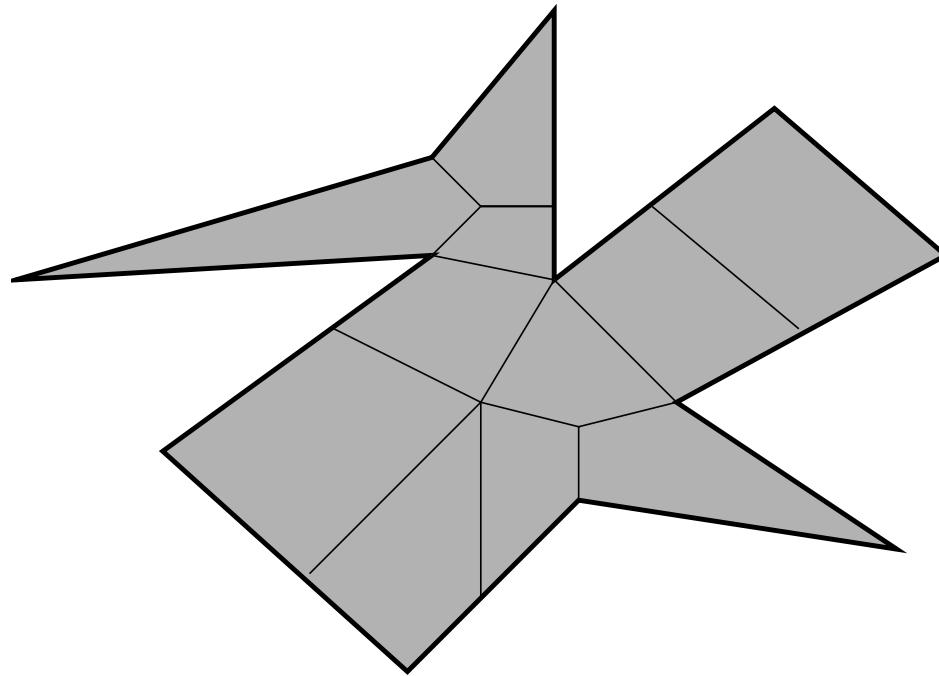



Marshal Bern



David Eppstein



David Epstein



David Eppstein

$P$  = hyperbolic geometry, University of Warwick

$P^2$  = computational geometry, UC Irvine



Bern asked: can we bound angles from below?

Bern asked: can we bound angles from below?

**Theorem:** Every  $n$ -gon has  $O(n)$  quad mesh with all angles  $\leq 120^\circ$  and new angles  $\geq 60^\circ$ .  $O(n)$  work.

Bern asked: can we bound angles from below?

**Theorem:** Every  $n$ -gon has  $O(n)$  quad mesh with all angles  $\leq 120^\circ$  and new angles  $\geq 60^\circ$ .  $O(n)$  work.

Original angles  $< 60^\circ$  remain unchanged.  $60^\circ$  is sharp.

Proof uses conformal mapping, plus an idea from hyperbolic manifolds: **thick/thin decompositions**.

Surface **thin part** is union of short non-trivial loops.

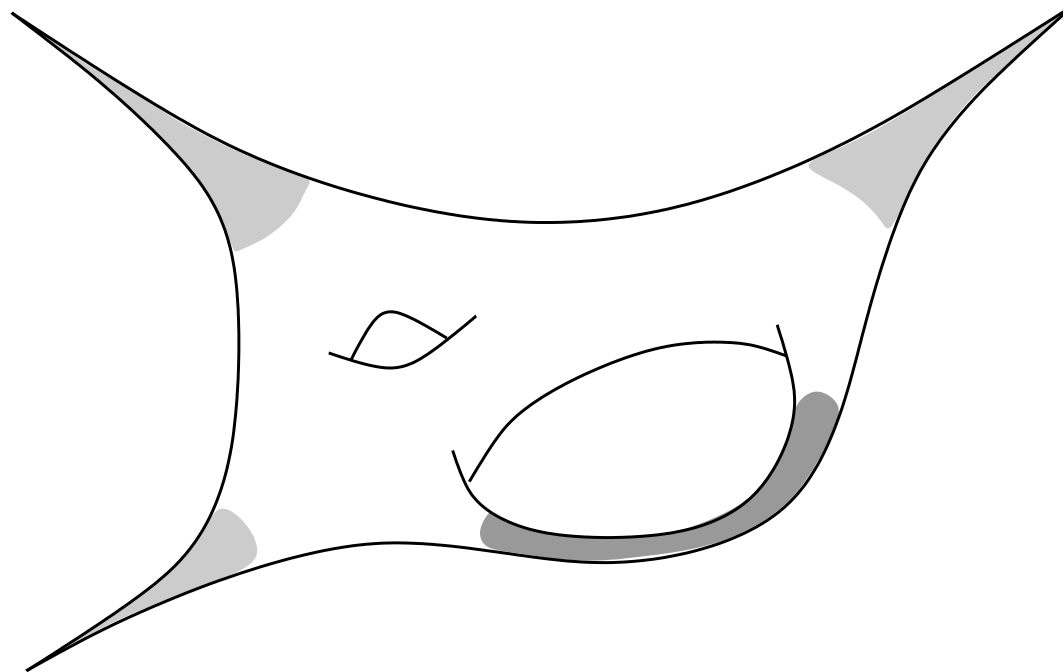

parabolic = puncture,      hyperbolic = handle

## Thick and Thin parts of a polygon

**Thin part** is union of short curves between edges.

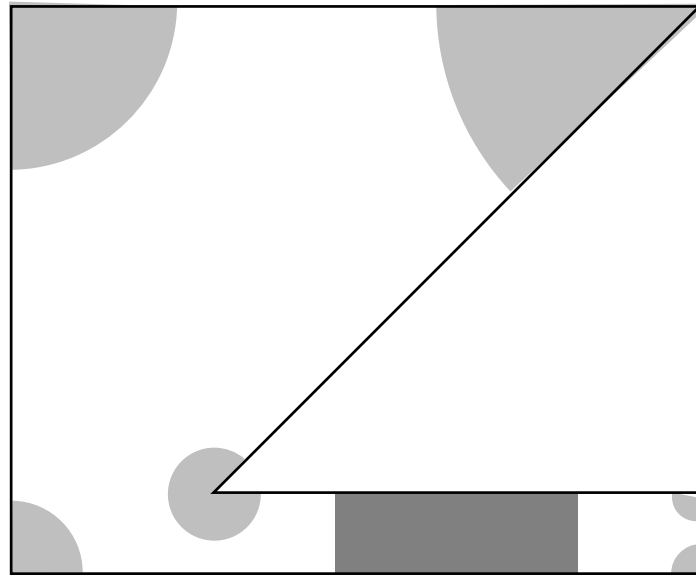

Parabolic = adjacent,      Hyperbolic = non-adjacent

**Rough idea:** sides  $I, J$  so  $\text{dist}(I, J) \ll \min(|I|, |J|)$ .

Thick parts = remaining components (white)

More examples of hyperbolic thin parts.

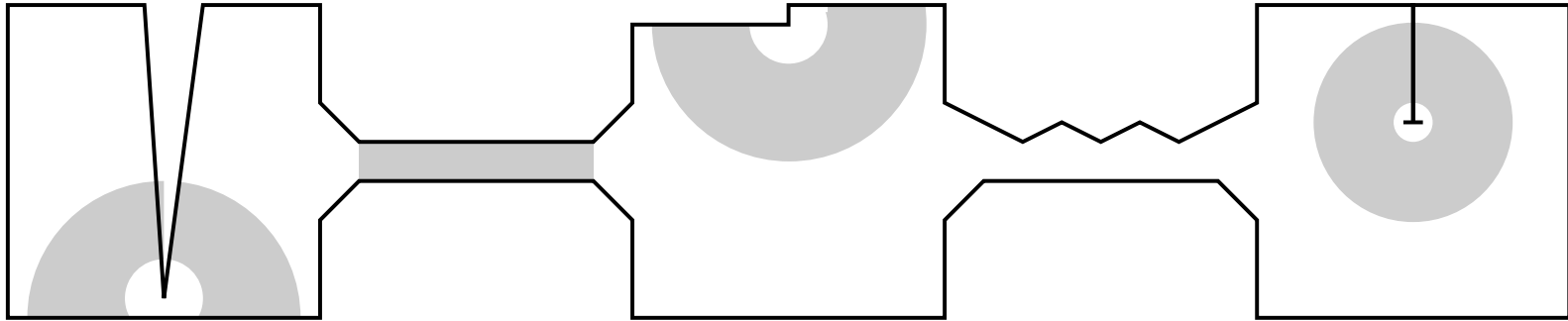

Inside thick regions (white) conformal pre-vertices are well separated on circle (no clusters).

Implies good estimates for conformal map.

Find thick parts in  $O(n)$  by conformal mapping.

Pre-vertices of thick parts form clusters on unit circle.

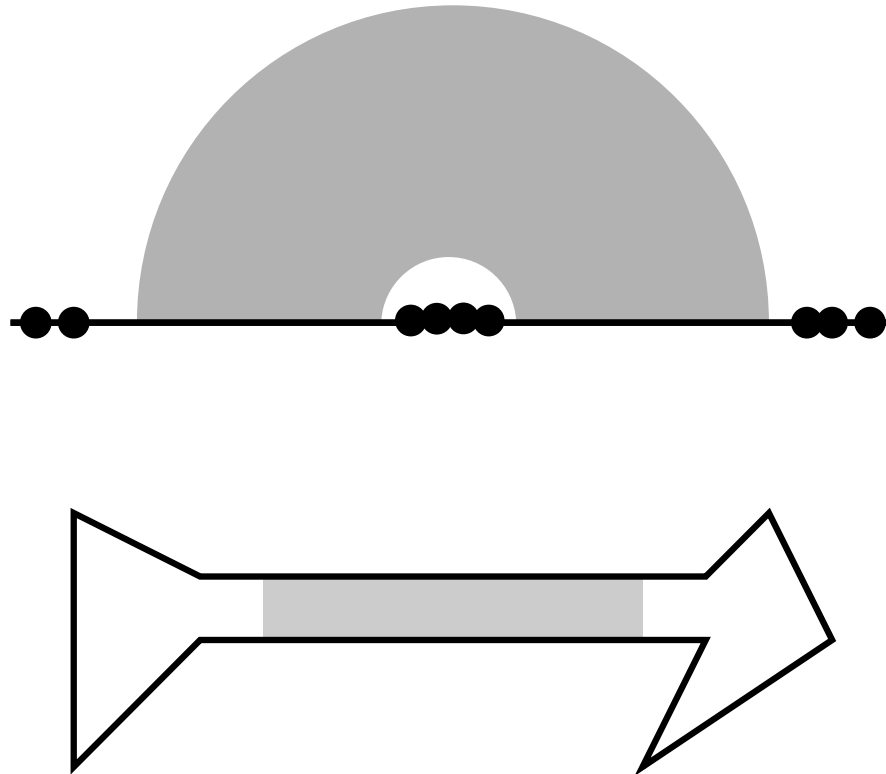

Clusters can be found in  $O(n)$  using medial axis.

## Idea for quad mesh theorem:

- Decompose polygon into  $O(n)$  thick and thin parts.
- Mesh thin parts “by hand”.
- Conformally map mesh on disk to thick parts.



**Thick parts:** transfer mesh from disk

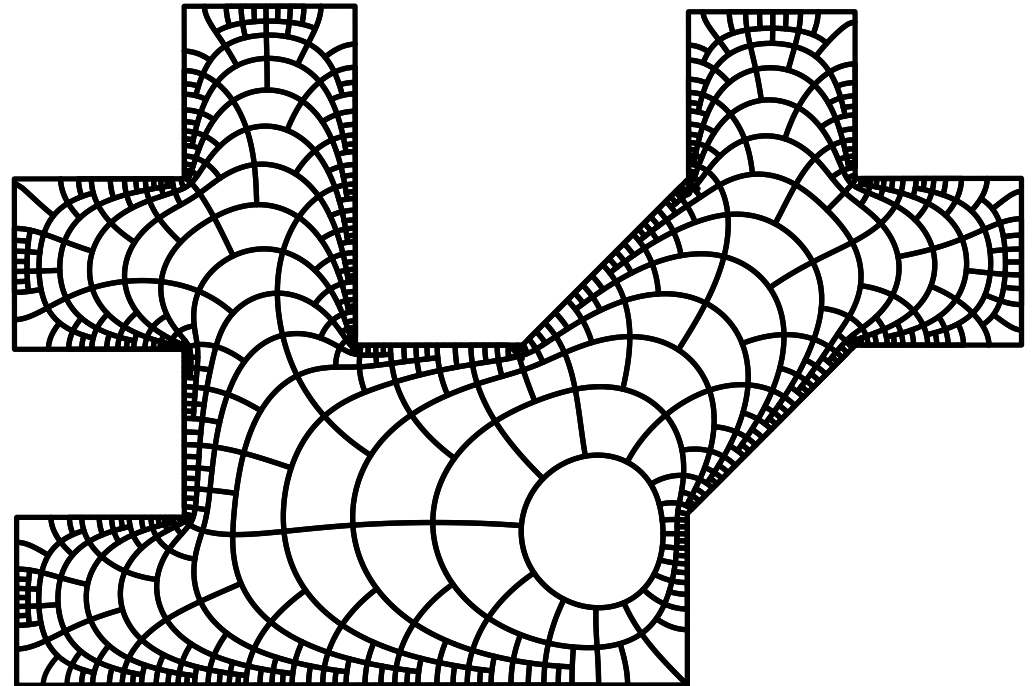
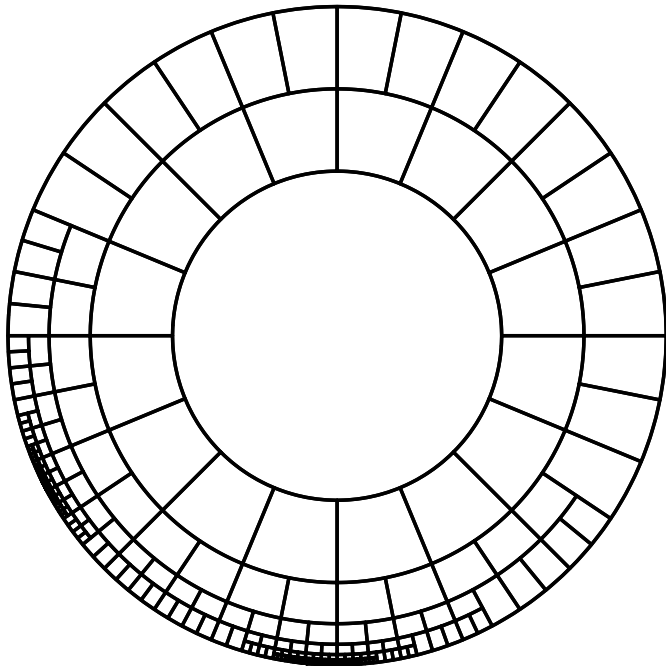

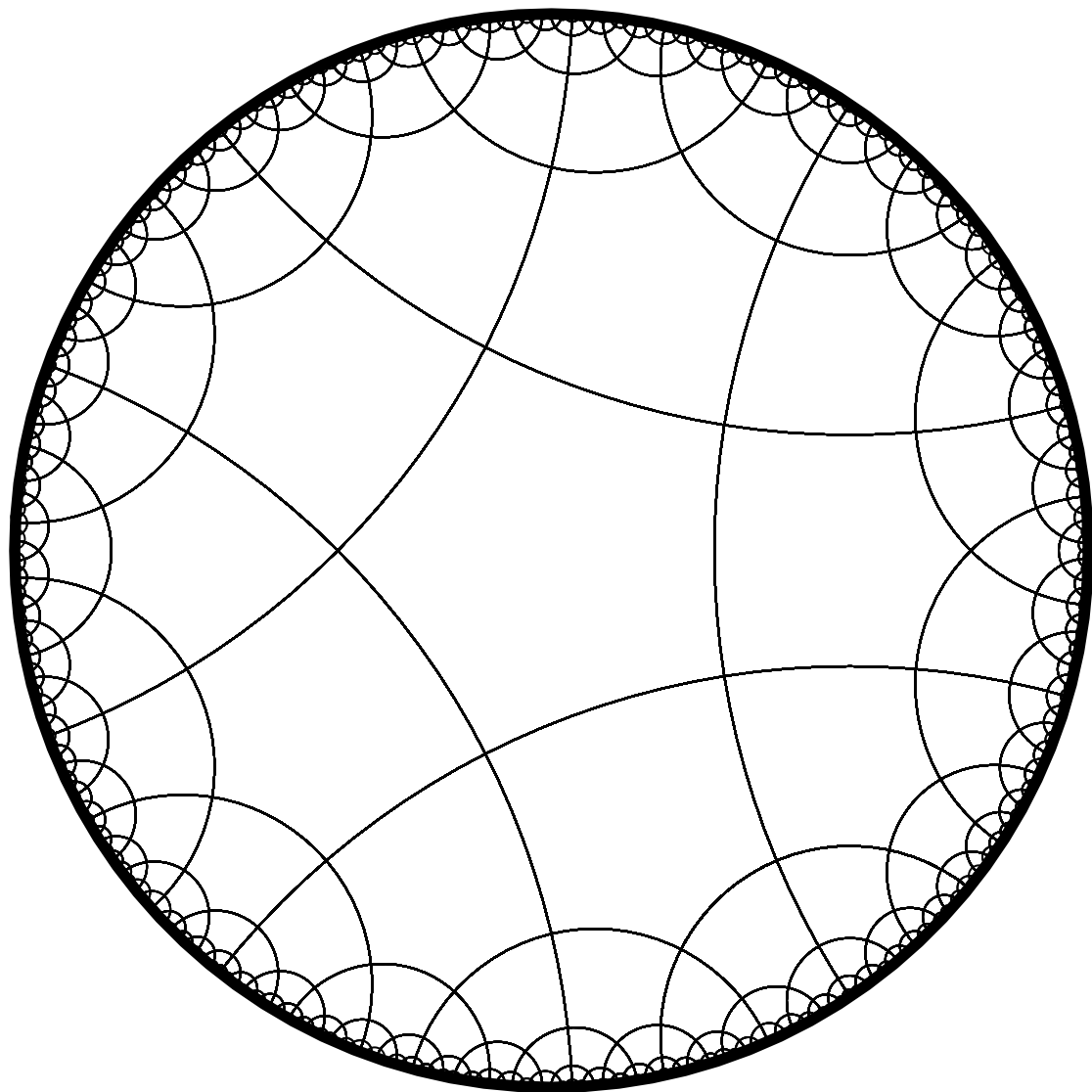

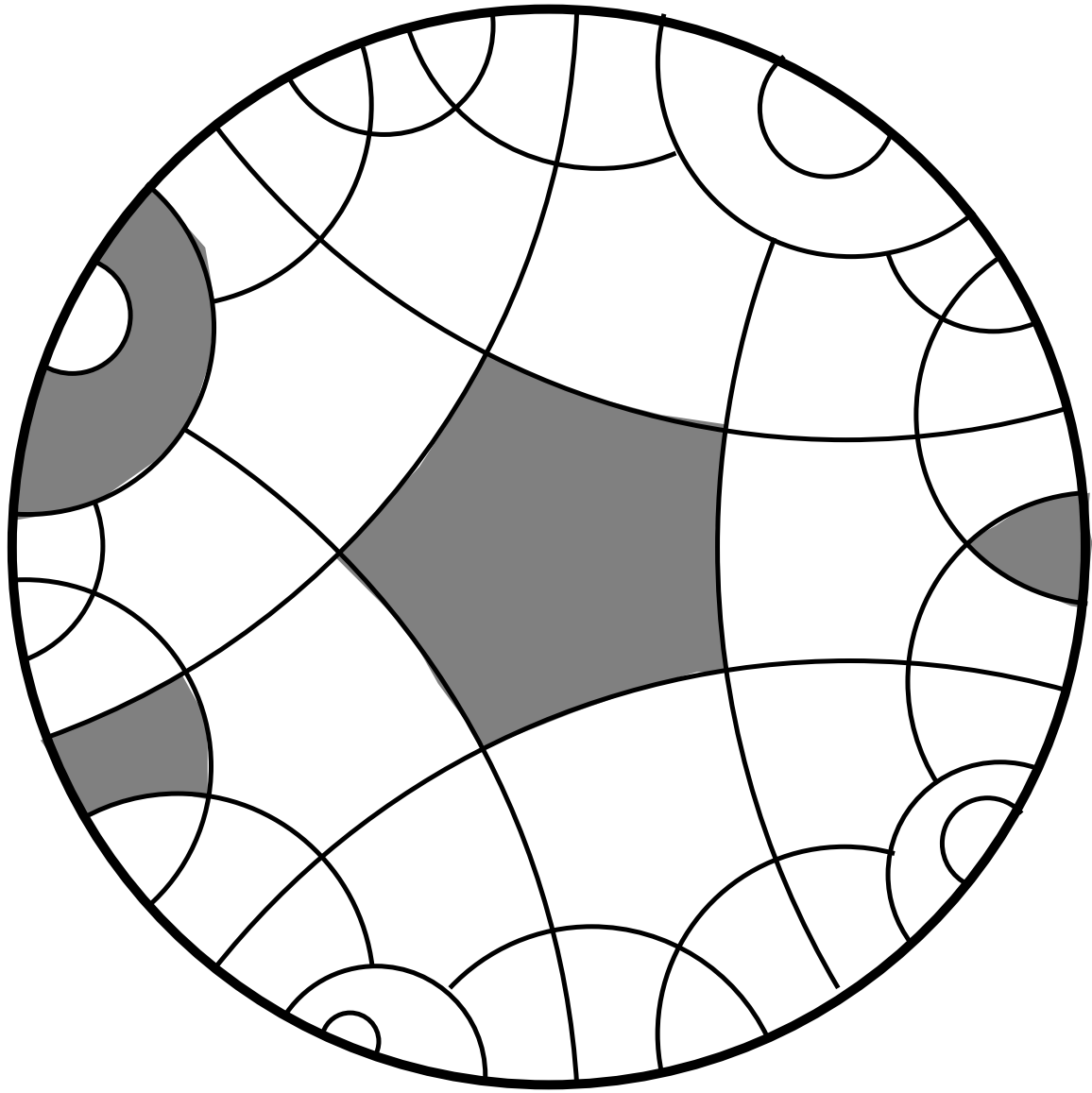

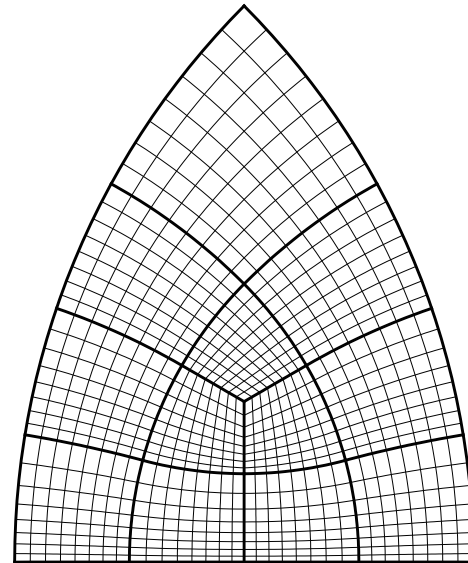
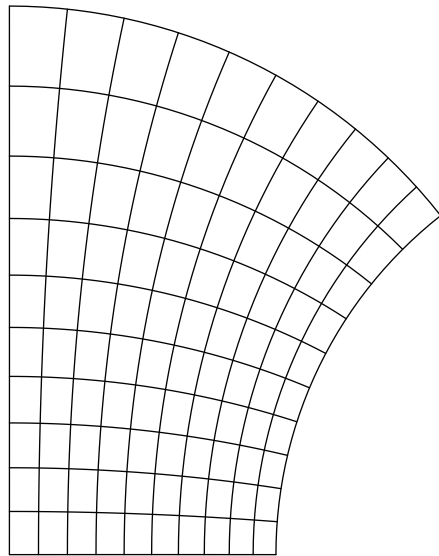
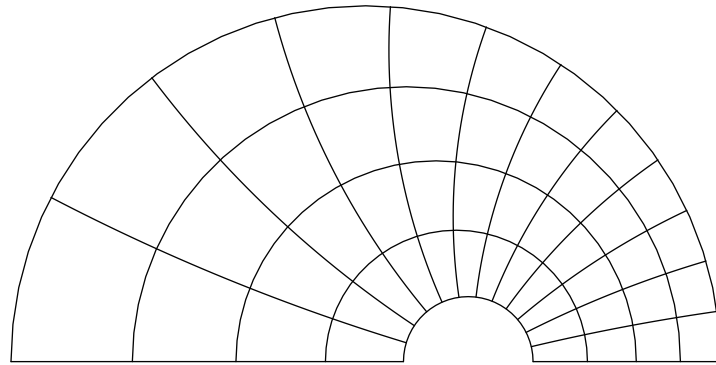
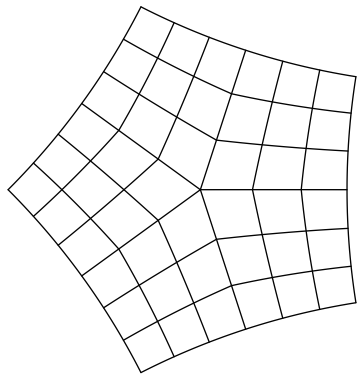

Meshes designed to match along common edges.

A **Planar Straight Line Graph** (PSLG) is a finite point set plus a set of disjoint edges between them.

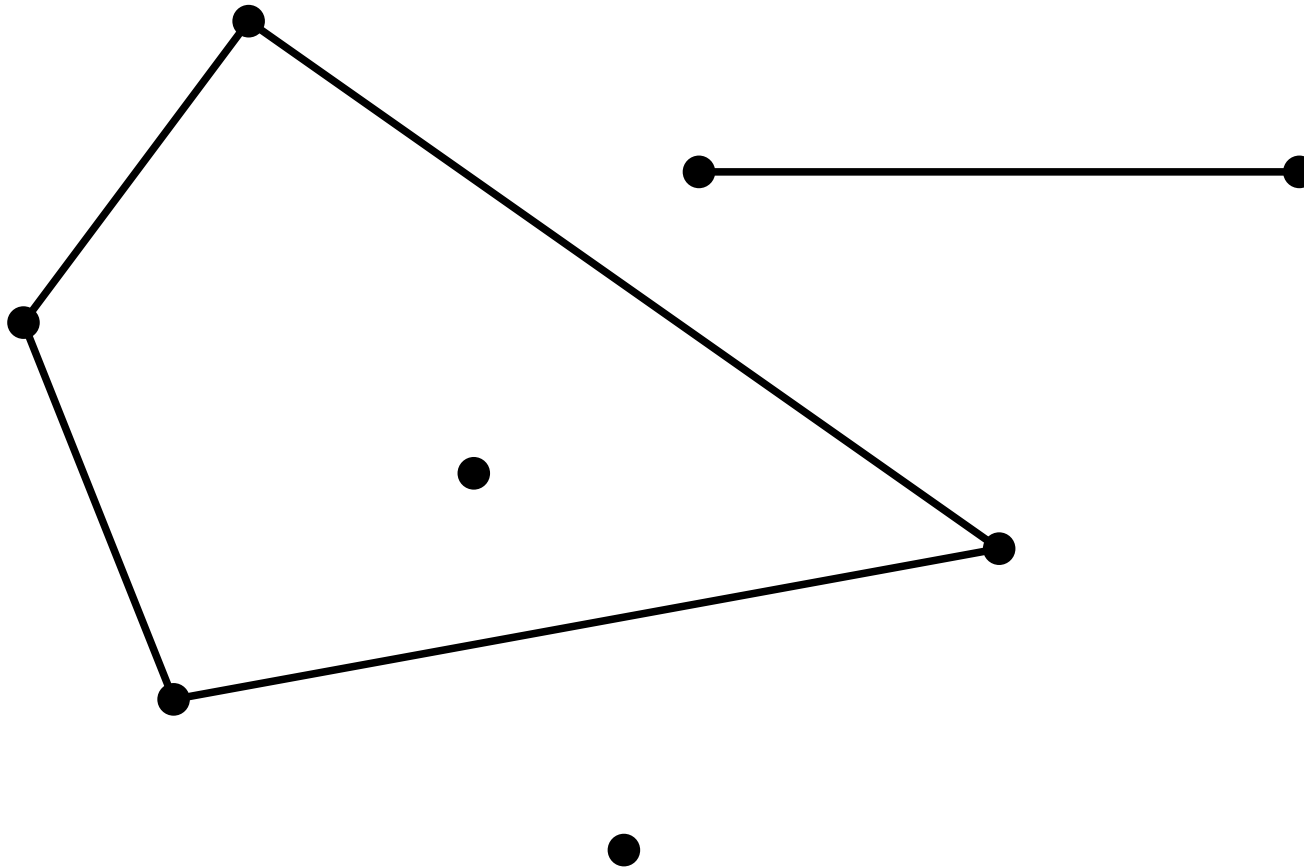

A **triangulation** is a maximal set of disjoint edges.

A **Planar Straight Line Graph** (PSLG) is a finite point set plus a set of disjoint edges between them.

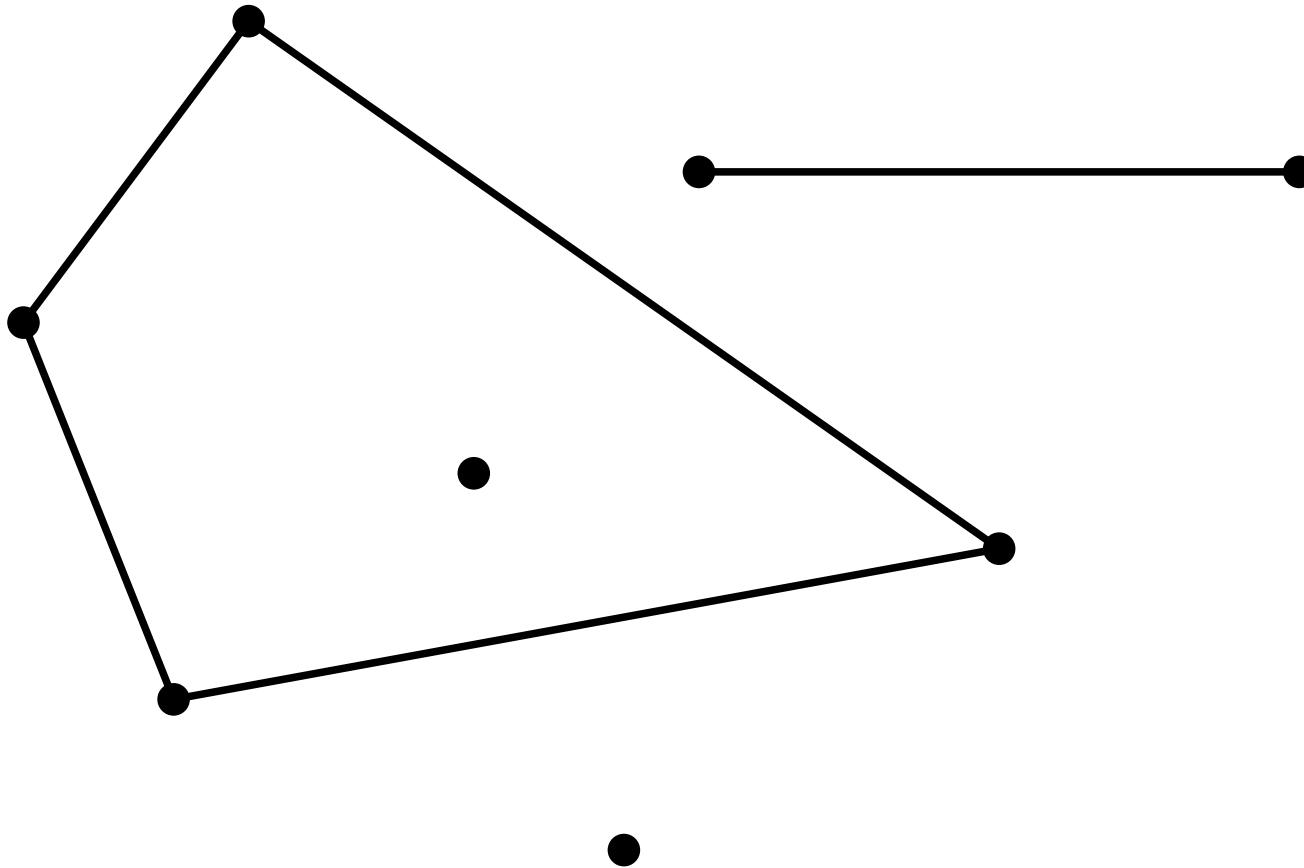

Size = number of vertices =  $n$ .

A **Planar Straight Line Graph** (PSLG) is a finite point set plus a set of disjoint edges between them.

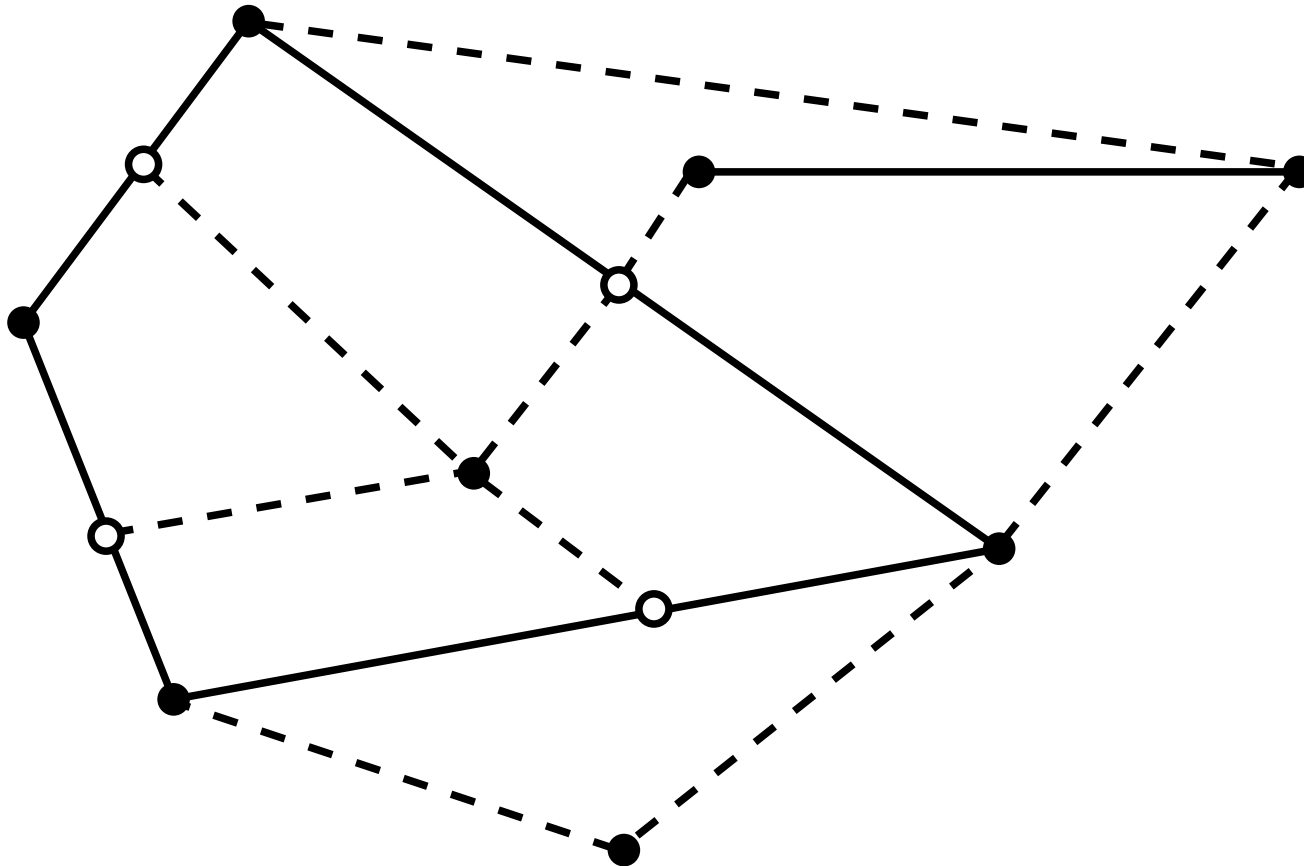

Mesh convex hull conforming to PSLG.

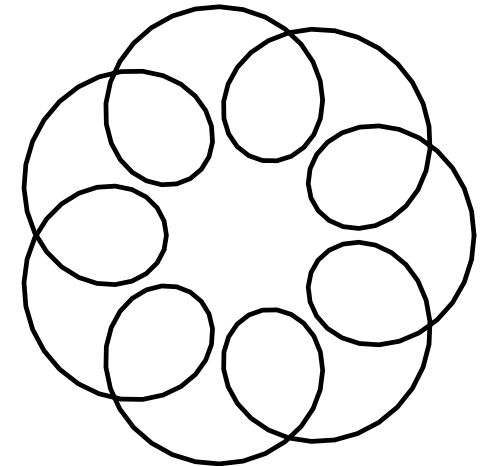
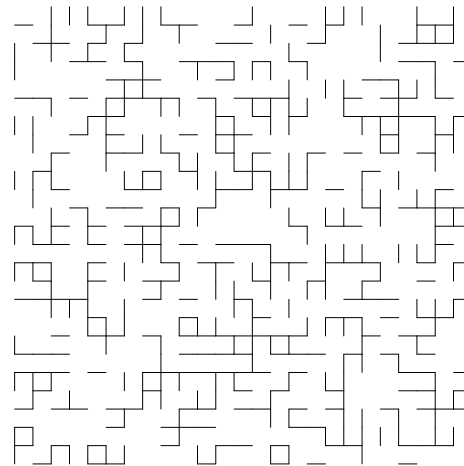
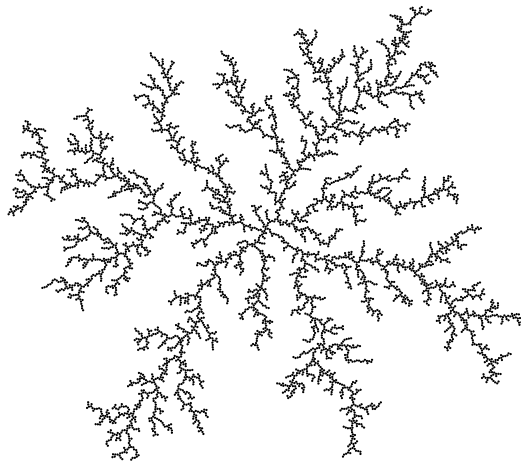
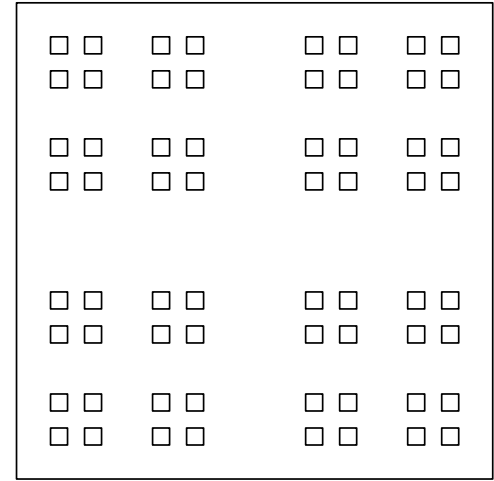
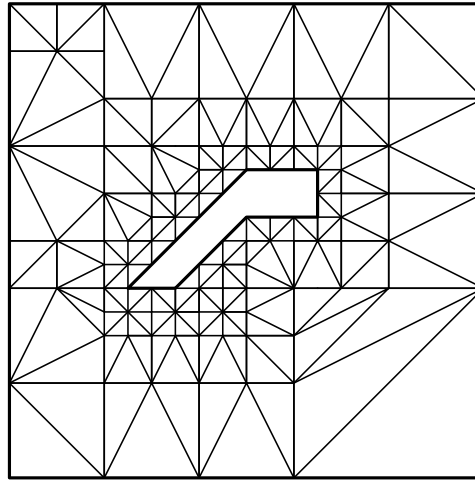
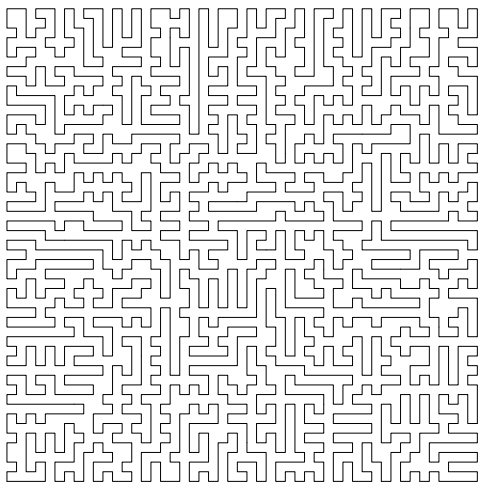

More PSLGs



**Theorem:** Every PSLG of size  $n$  has  $O(n^2)$  quad mesh with all angles  $\leq 120^\circ$  and all new angles  $\geq 60^\circ$ .

Angles and complexity sharp.

**Theorem:** Every PSLG of size  $n$  has  $O(n^2)$  quad mesh with all angles  $\leq 120^\circ$  and all new angles  $\geq 60^\circ$ .

Convert quadrilaterals to triangles by adding diagonals.

**Theorem:** Every PSLG of size  $n$  has  $O(n^2)$  quad mesh with all angles  $\leq 120^\circ$  and all new angles  $\geq 60^\circ$ .

Convert quadrilaterals to triangles by adding diagonals.

**Corollary:** Every PSLG has a  $O(n^2)$  triangulation with maximum angle  $\leq 120^\circ$ .

**Theorem:** Every PSLG of size  $n$  has  $O(n^2)$  quad mesh with all angles  $\leq 120^\circ$  and all new angles  $\geq 60^\circ$ .

Convert quadrilaterals to triangles by adding diagonals.

**Corollary:** Every PSLG has a  $O(n^2)$  triangulation with maximum angle  $\leq 120^\circ$ .

Previous: S. Mitchell 1993 ( $157.5^\circ$ ), Tan 1996 ( $132^\circ$ ).

Can we improve the  $120^\circ$  upper bound?

Can we get a positive lower bound on angles?

**Theorem:** Every PSLG of size  $n$  has  $O(n^2)$  quad mesh with all angles  $\leq 120^\circ$  and all new angles  $\geq 60^\circ$ .

Convert quadrilaterals to triangles by adding diagonals.

**Corollary:** Every PSLG has a  $O(n^2)$  triangulation with maximum angle  $\leq 120^\circ$ .

Previous: S. Mitchell 1993 ( $157.5^\circ$ ), Tan 1996 ( $132^\circ$ ).

Can we improve the  $120^\circ$  upper bound? **Yes**

Can we get a positive lower bound on angles? **No**

**No lower angle bound.** For  $1 \times R$  rectangle  
number of triangles  $\gtrsim R \times (\text{smallest angle})$

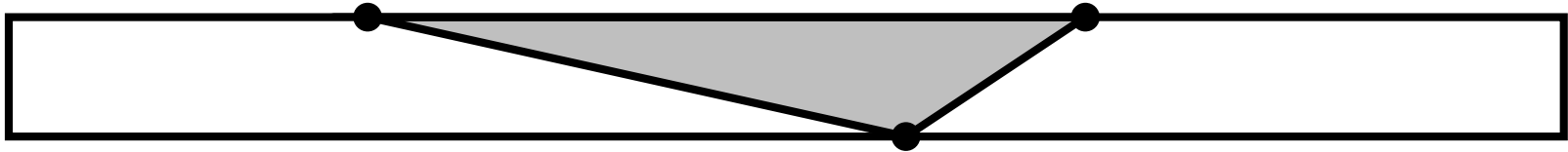

So, bounded complexity  $\Rightarrow$  no lower angle bound.

Upper bound  $< 90^\circ$  implies lower bound  $> 0$ :

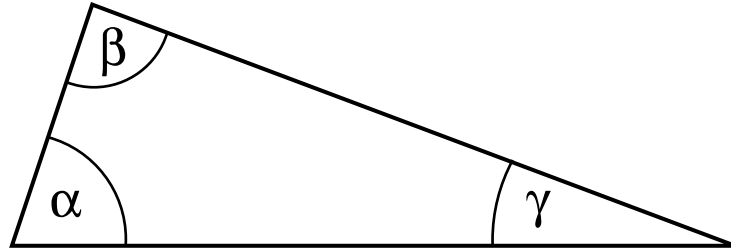

$$\alpha, \beta < (90^\circ - \epsilon) \Rightarrow \gamma = 180^\circ - \alpha - \beta \geq 2\epsilon.$$

Upper bound  $< 90^\circ$  implies lower bound  $> 0$ :

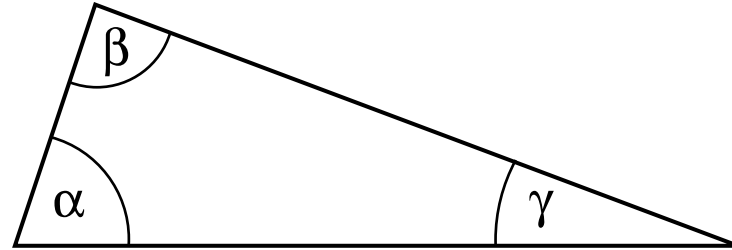

$$\alpha, \beta < (90^\circ - \epsilon) \Rightarrow \gamma = 180^\circ - \alpha - \beta \geq 2\epsilon.$$

So  $90^\circ$  is best uniform upper bound we can hope for.

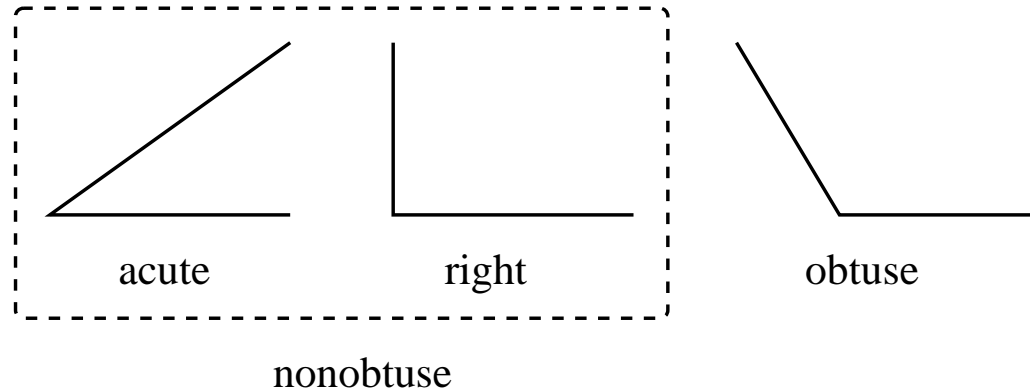

Is NOT="non-obtuse triangulation" possible?



Upper bound  $< 90^\circ$  implies lower bound  $> 0$ :

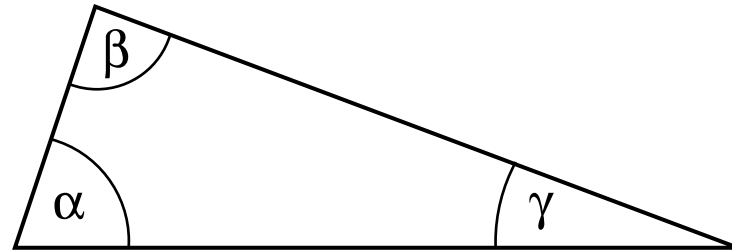

$$\alpha, \beta < (90^\circ - \epsilon) \Rightarrow \gamma = 180^\circ - \alpha - \beta \geq 2\epsilon.$$

So  $90^\circ$  is best uniform upper bound we can hope for.

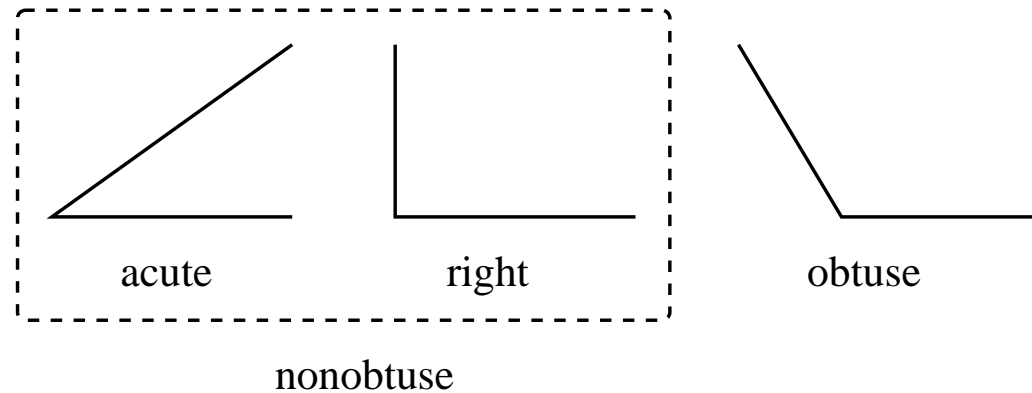

Is NOT="non-obtuse triangulation" possible? **Yes**

## Brief history of NOTs:

- Always possible: Burago, Zalgaller 1960.
- Rediscovered: Baker, Grosse, Rafferty, 1988.
- $O(n)$  for points sets: Bern, Eppstein, Gilbert 1990
- $O(n^2)$  for polygons: Bern, Eppstein, 1991
- $O(n)$  for polygons: Bern, Mitchell, Ruppert, 1994
- PSLG's: exist,  $n^2$  lower bound

Do a polynomial number of triangles suffice?

**NOT-Theorem:** Every PSLG has an  $O(n^{2.5})$ -NOT.

**NOT-Theorem:** Every PSLG has an  $O(n^{2.5})$ -NOT.

$O(n^2)$  is best known lower bound, so a gap remains.

$C_\epsilon \cdot n^2$  is true if angles  $\leq 90^\circ + \epsilon$ .

**NOT-Theorem:** Every PSLG has an  $O(n^{2.5})$ -NOT.

**Equivalent:** Every planar triangulation has  $O(n^{2.5})$  non-obtuse refinement.

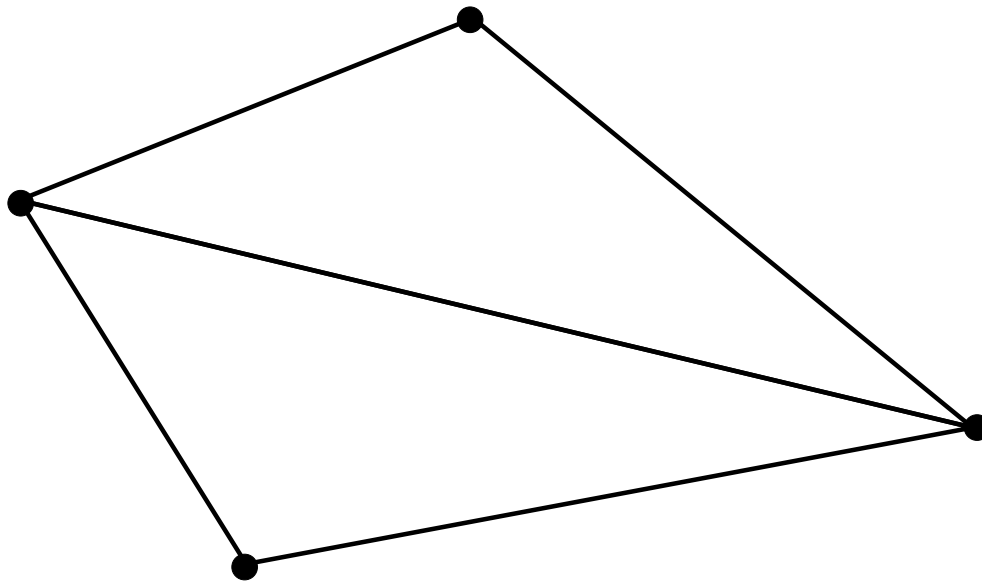

**NOT-Theorem:** Every PSLG has an  $O(n^{2.5})$ -NOT.

**Equivalent:** Every planar triangulation has  $O(n^{2.5})$  non-obtuse refinement.

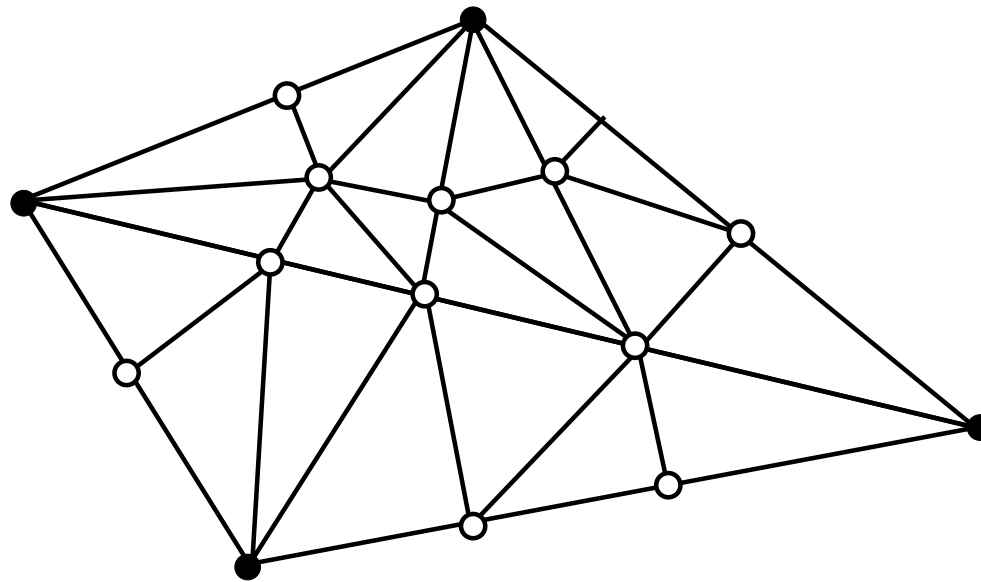

The segment  $[v, w]$  is a **Gabriel** edge if it is the diameter of a disk containing no other points of  $V$ .

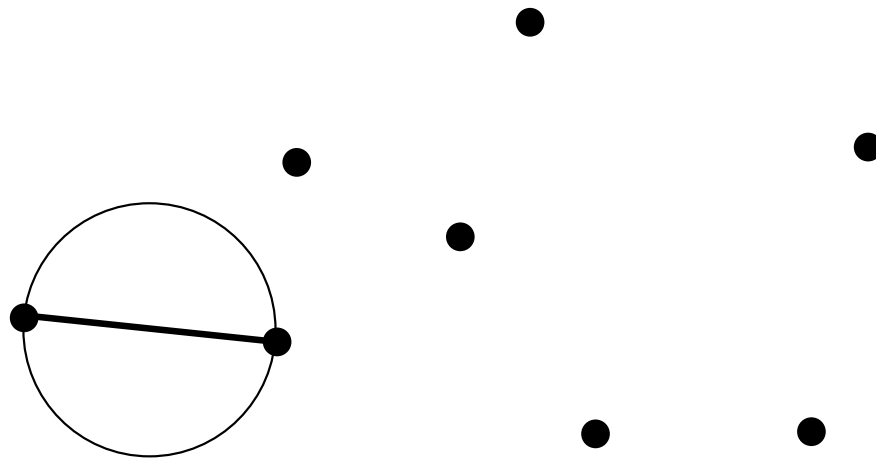

Gabriel edge.

The segment  $[v, w]$  is a **Gabriel** edge if it is the diameter of a disk containing no other points of  $V$ .

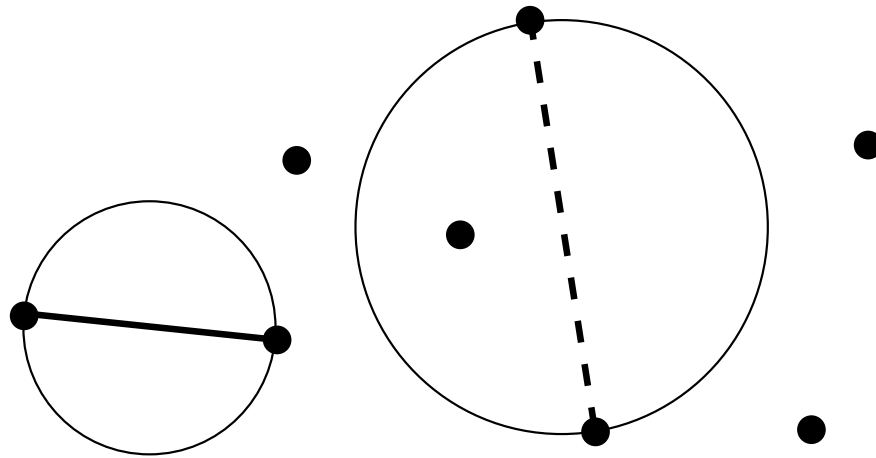

Not a Gabriel edge.



The segment  $[v, w]$  is a **Gabriel** edge if it is the diameter of a disk containing no other points of  $V$ .

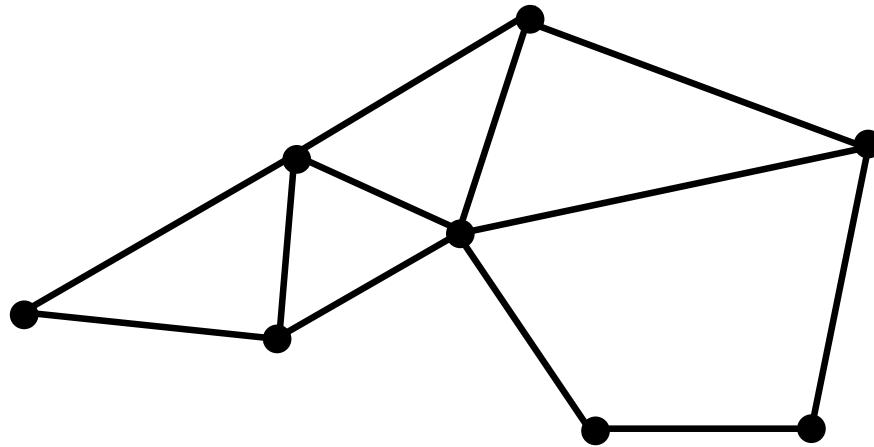

Gabriel graph contains the minimal spanning tree.

Gabriel edge is a special case of a **Delaunay** edge:  
 $[v, w]$  is a **chord** of an open disk not hitting  $V$ .

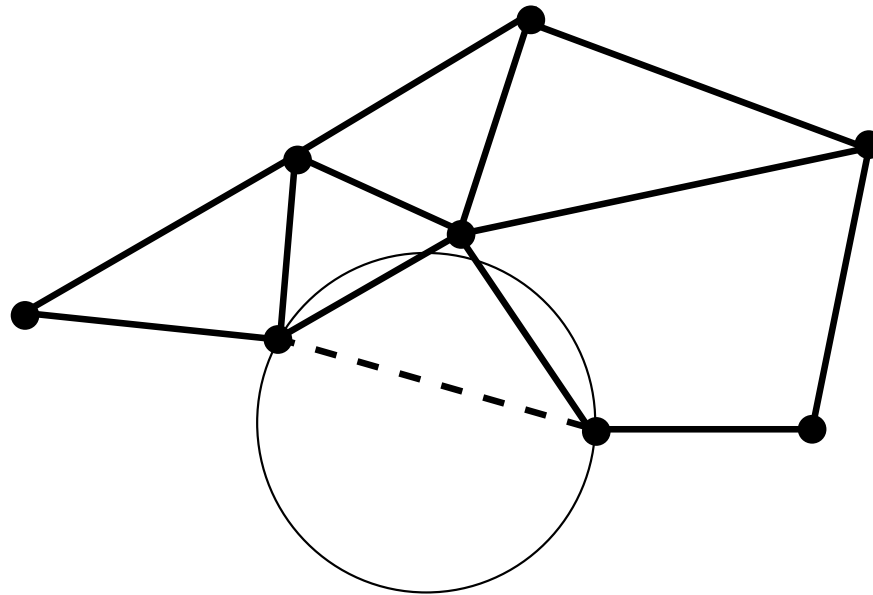

Gabriel edge is a special case of a **Delaunay** edge:  
 $[v, w]$  is a **chord** of an open disk not hitting  $V$ .

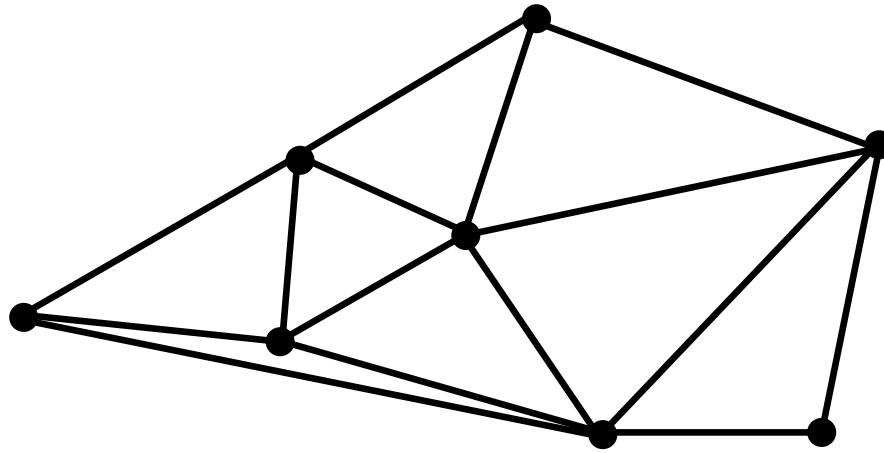

Delaunay edges triangulate.

DT minimizes the maximum angle.

Thus, if a point set has a NOT, then  $DT = NOT$ .

A triangulation **conforms** to a PSLG if it covers the PSLG. The NOT-theorem says:

**Thm:** Any PSLG has  $O(n^{2.5})$  conforming NOT-DT.

A triangulation **conforms** to a PSLG if it covers the PSLG. The NOT-theorem says:

**Thm:** Any PSLG has  $O(n^{2.5})$  conforming NOT-DT.

If we forget the angle bound we get:

**Cor:** Any PSLG has  $O(n^{2.5})$  conforming DT.

A triangulation **conforms** to a PSLG if it covers the PSLG. The NOT-theorem says:

**Thm:** Any PSLG has  $O(n^{2.5})$  conforming NOT-DT.

If we forget the angle bound we get:

**Cor:** Any PSLG has  $O(n^{2.5})$  conforming DT.

Edelsbrunner, Tan (1993) proved this with  $O(n^3)$ .

Is  $O(n^2)$  possible?

Easier proof giving conforming DT, but no angle bound?

**Known:** If we can add  $N$  points to a triangulation of  $n$  points so that every edge becomes Gabriel, then there is a  $O(n + N)$  conforming NOT-DT.

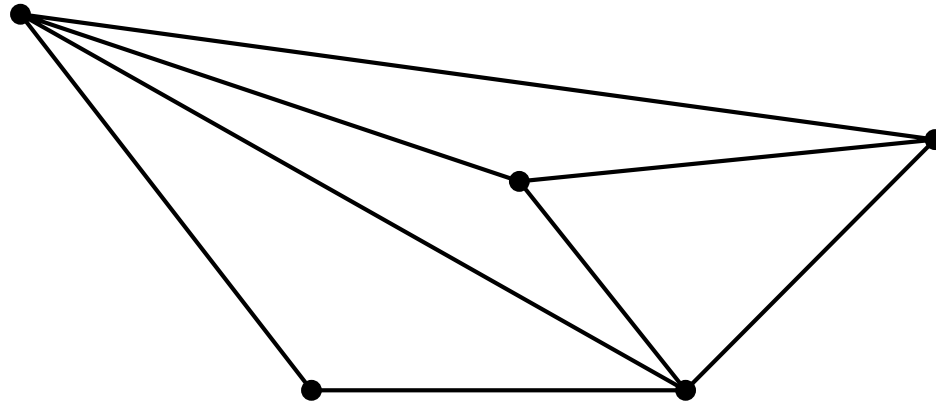

Follows from work of Bern, Mitchell, Ruppert (1994).

**Known:** If we can add  $N$  points to a triangulation of  $n$  points so that every edge becomes Gabriel, then there is a  $O(n + N)$  conforming NOT-DT.

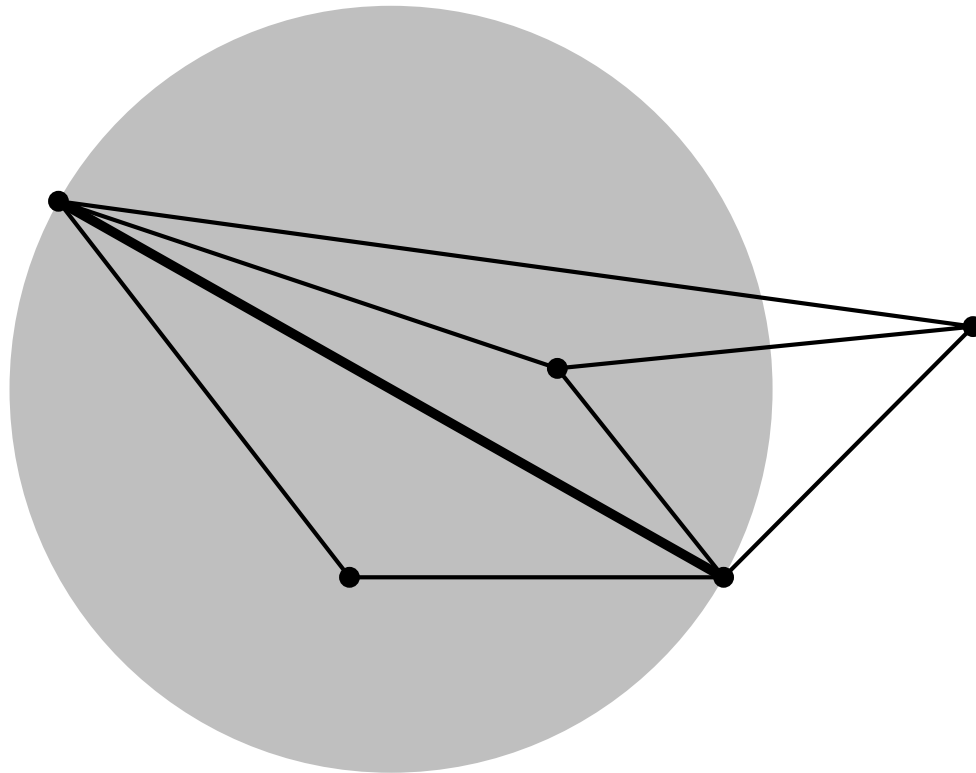



**Known:** If we can add  $N$  points to a triangulation of  $n$  points so that every edge becomes Gabriel, then there is a  $O(n + N)$  conforming NOT-DT.

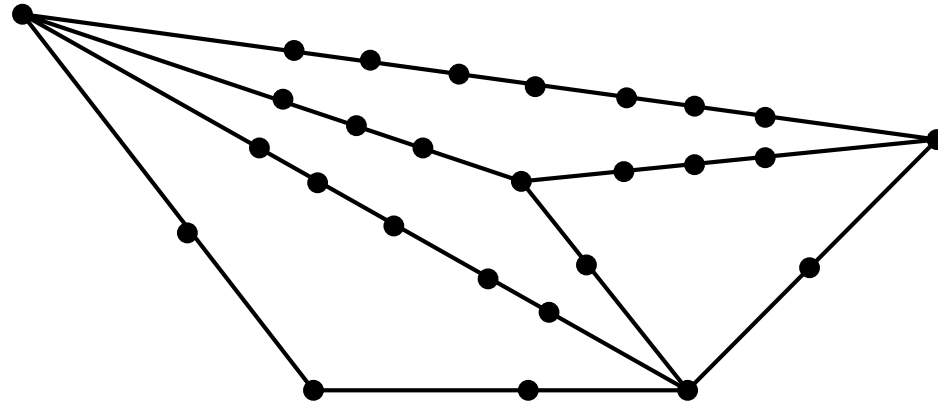

**Known:** If we can add  $N$  points to a triangulation of  $n$  points so that every edge becomes Gabriel, then there is a  $O(n + N)$  conforming NOT-DT.

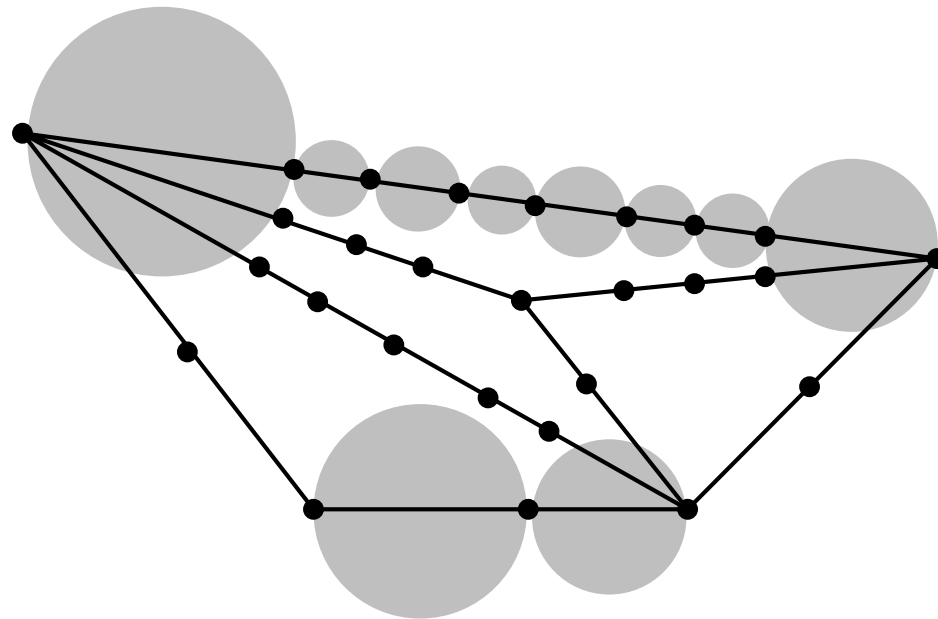

**Known:** If we can add  $N$  points to a triangulation of  $n$  points so that every edge becomes Gabriel, then there is a  $O(n + N)$  conforming NOT-DT.

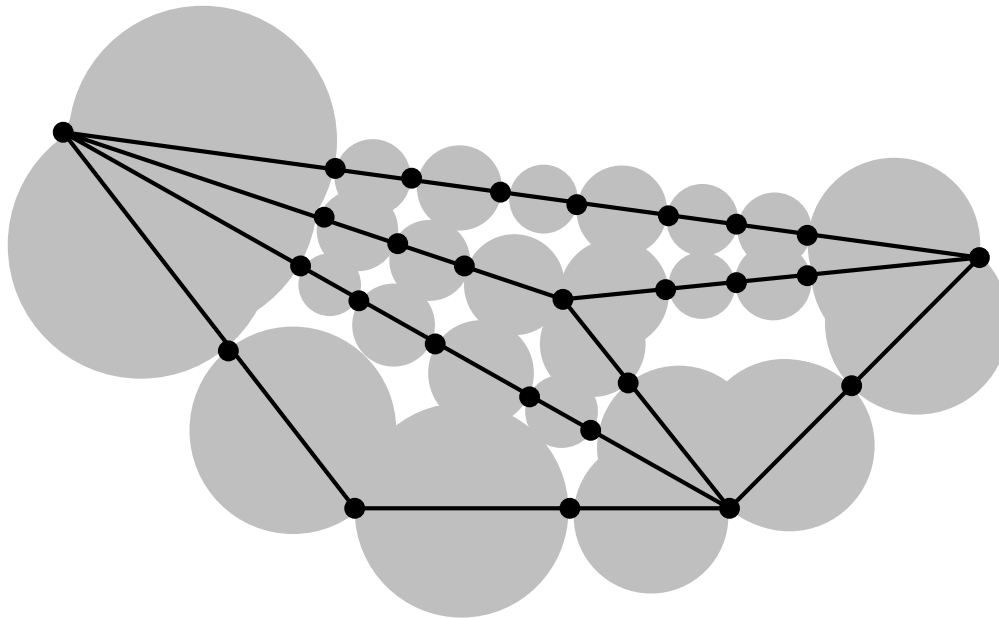

**Theorem:** Given a triangulation, we can add  $O(n^{2.5})$  points to the edges so that every new edge is Gabriel.

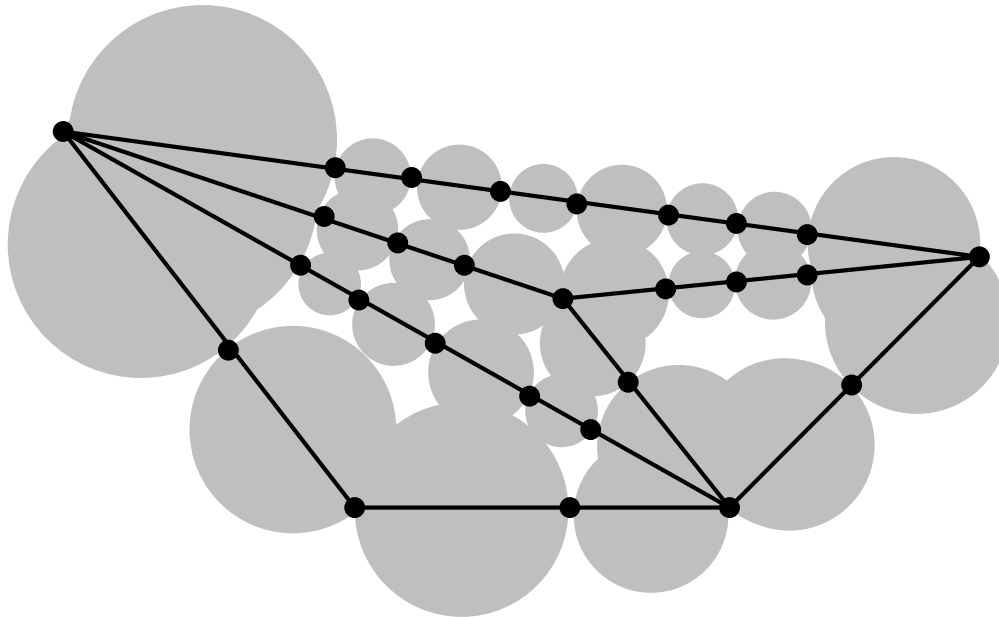

## Construct Gabriel points:

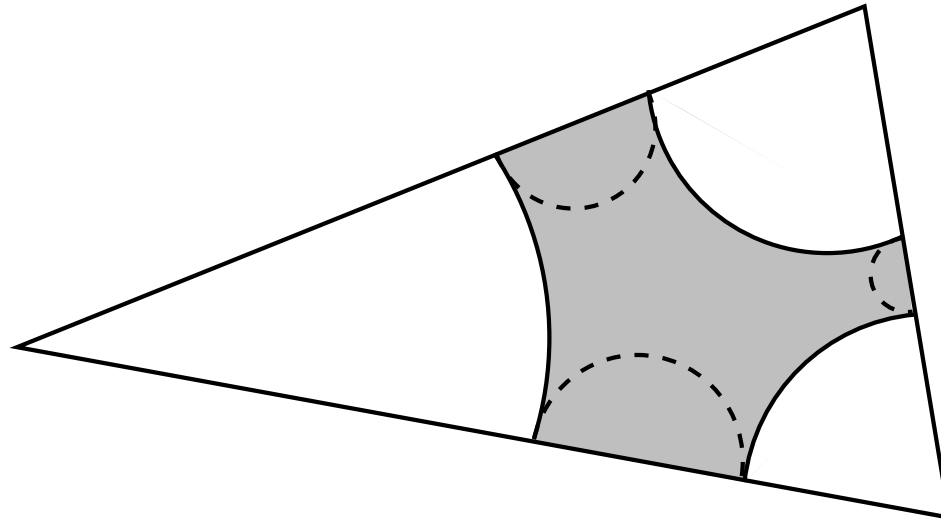

Divide triangle into thick and thin parts.

Thick sides are base of half-disk inside triangle.

**Construct Gabriel points:**

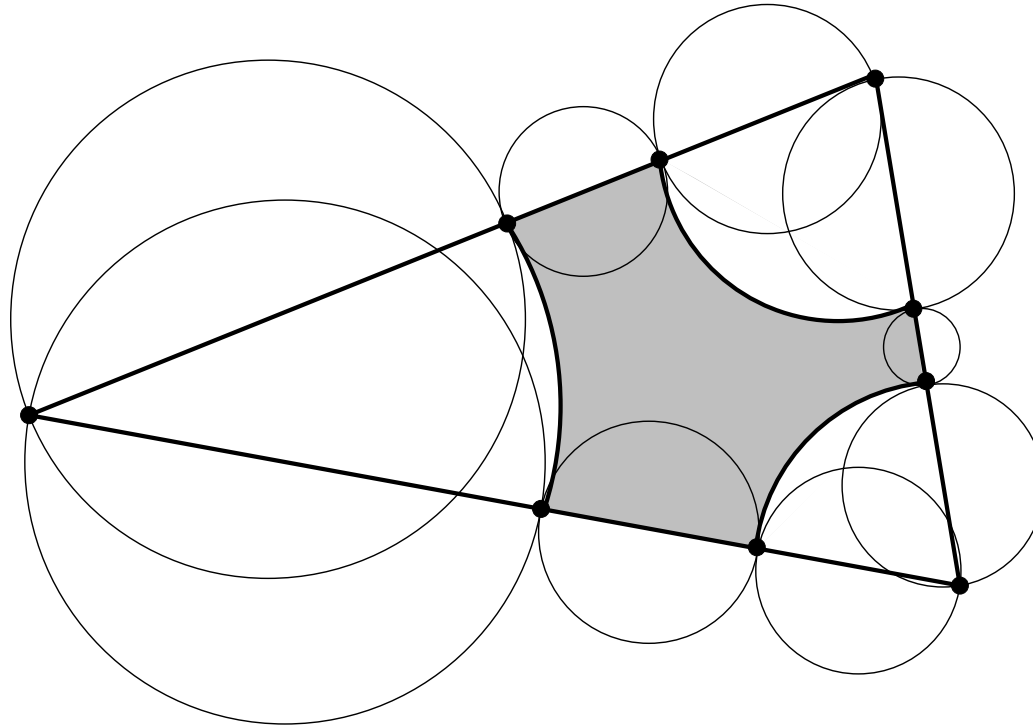

Then vertices of thick part give Gabriel edges.

Construct Gabriel points:

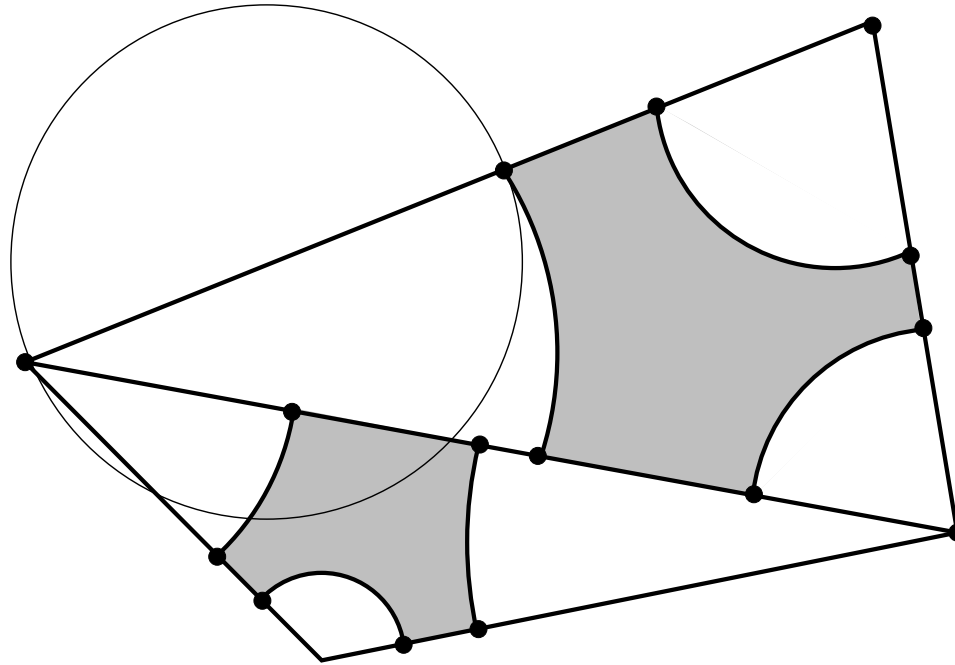

But, adjacent triangle can make Gabriel condition fail.

Construct Gabriel points:

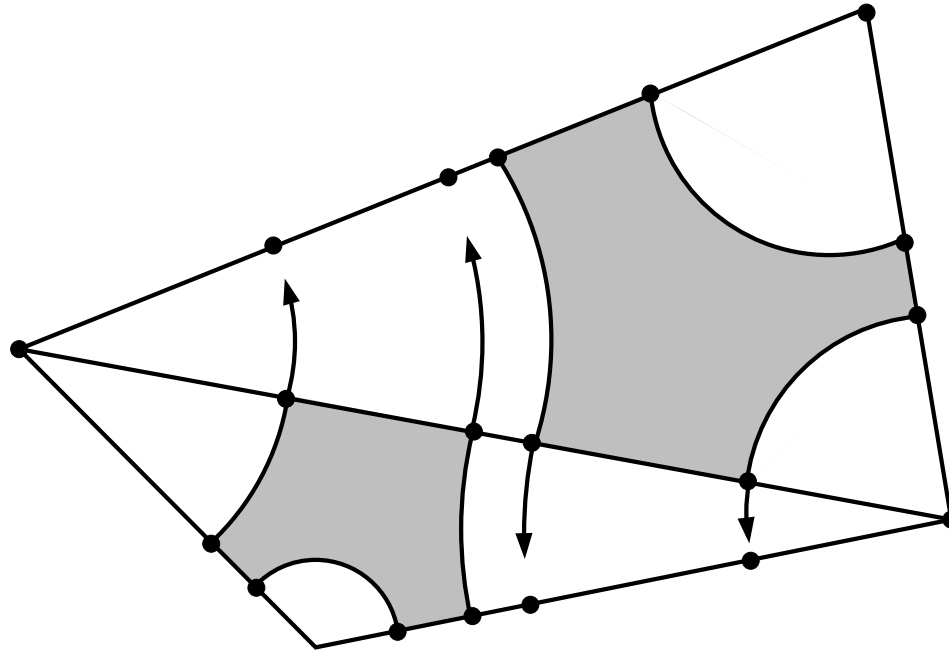

**Idea:** “Push” vertices across the thin parts.



## Construct Gabriel points:

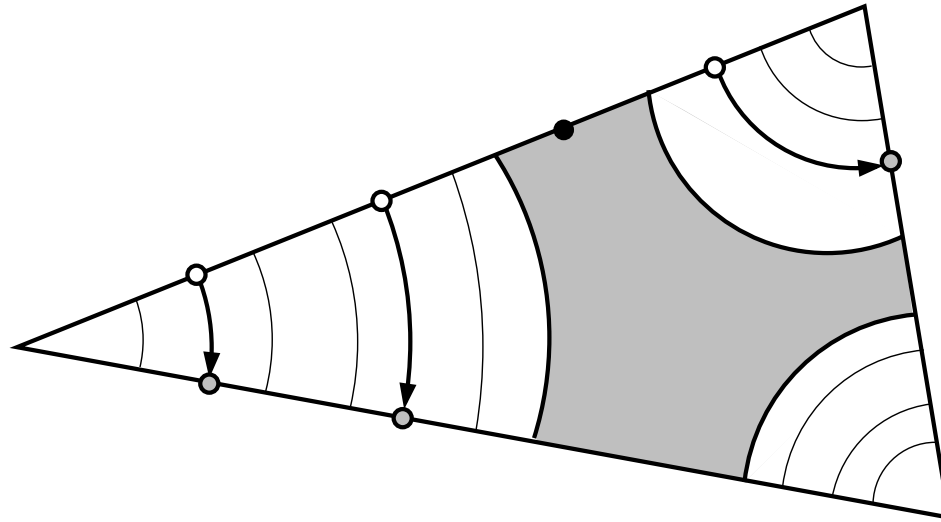

Thin parts foliated by circles centered at vertices.

Push vertices along foliation paths.

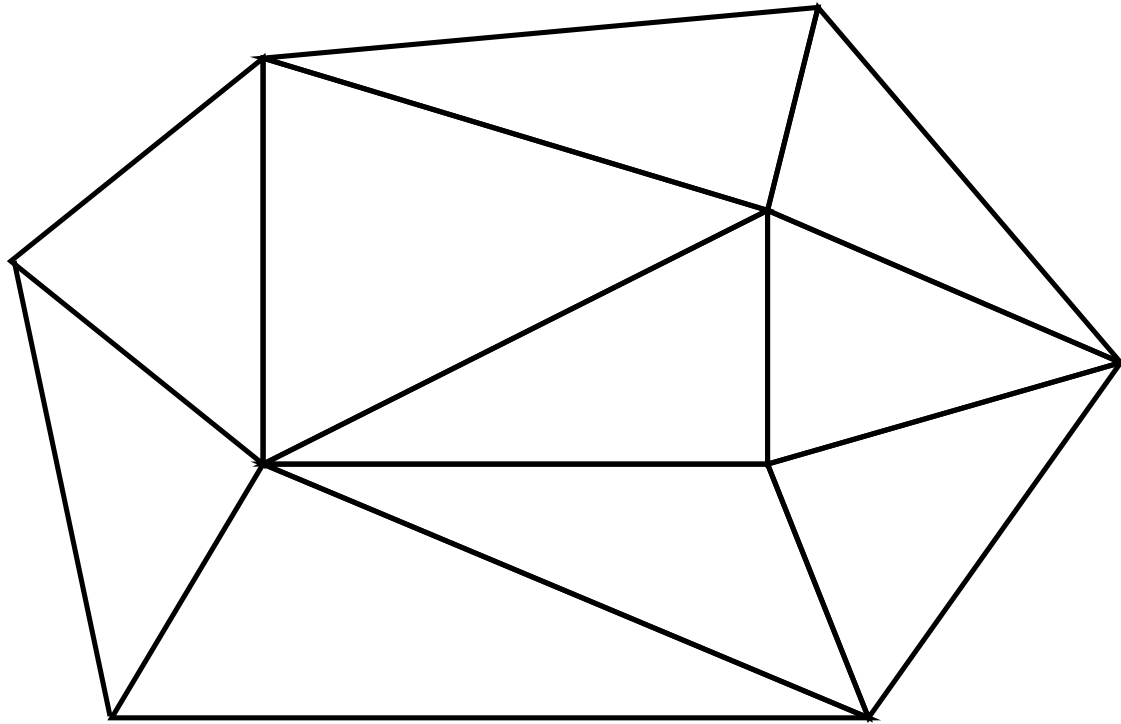

- Start with any triangulation.

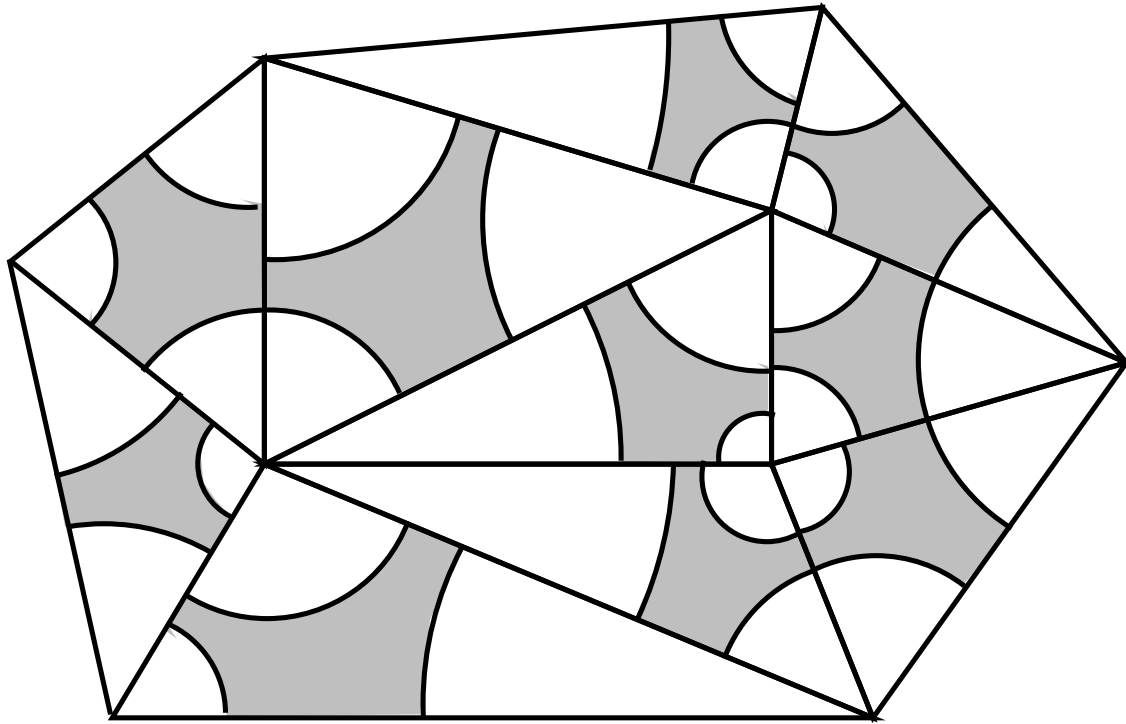

- Start with any triangulation.
- Make thick/thin parts.

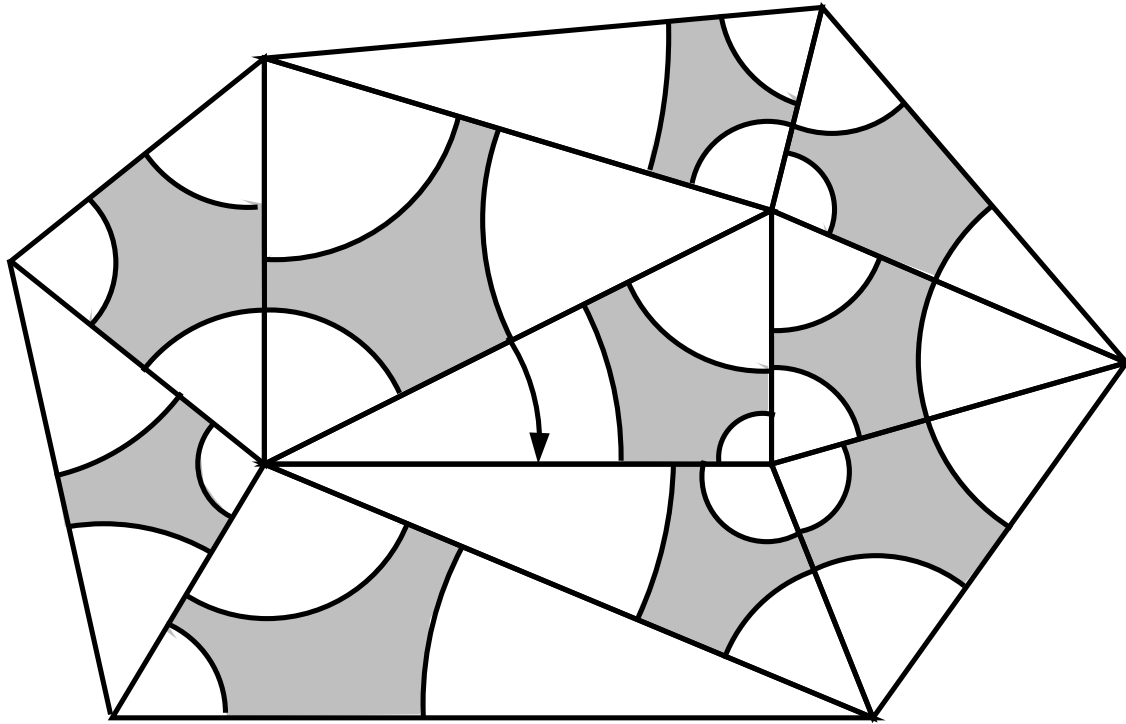

- Start with any triangulation.
- Make thick/thin parts.
- Propagate vertices until they leave thin parts.

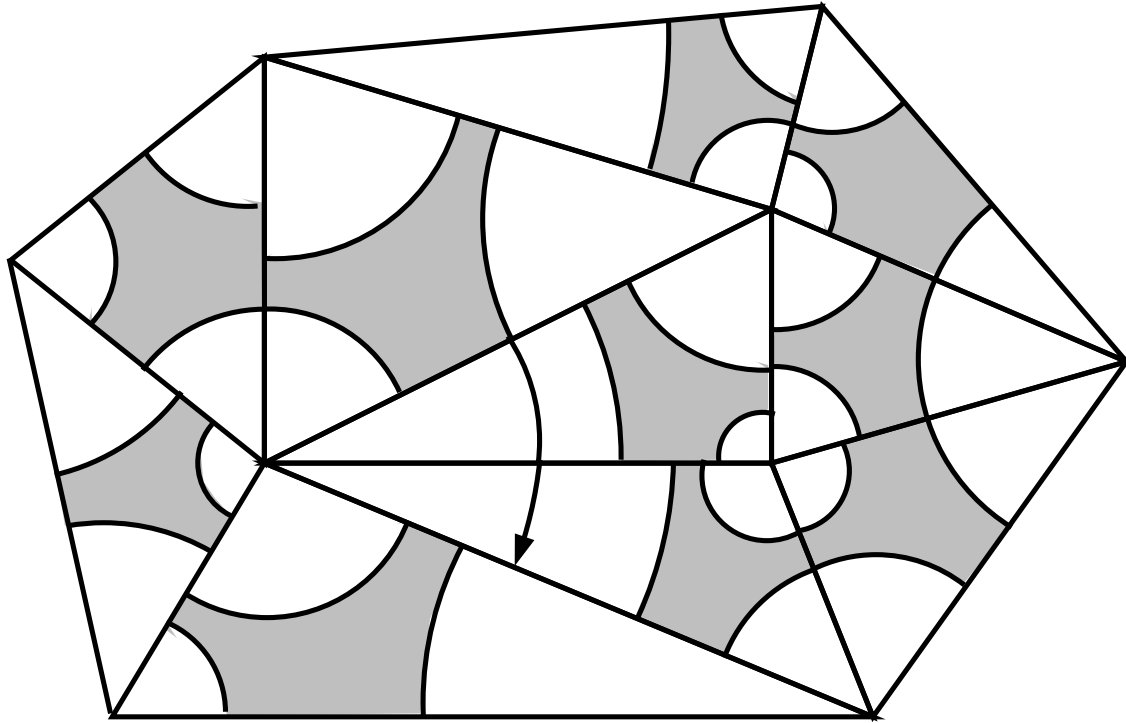

- Start with any triangulation.
- Make thick/thin parts.
- Propagate vertices until they leave thin parts.

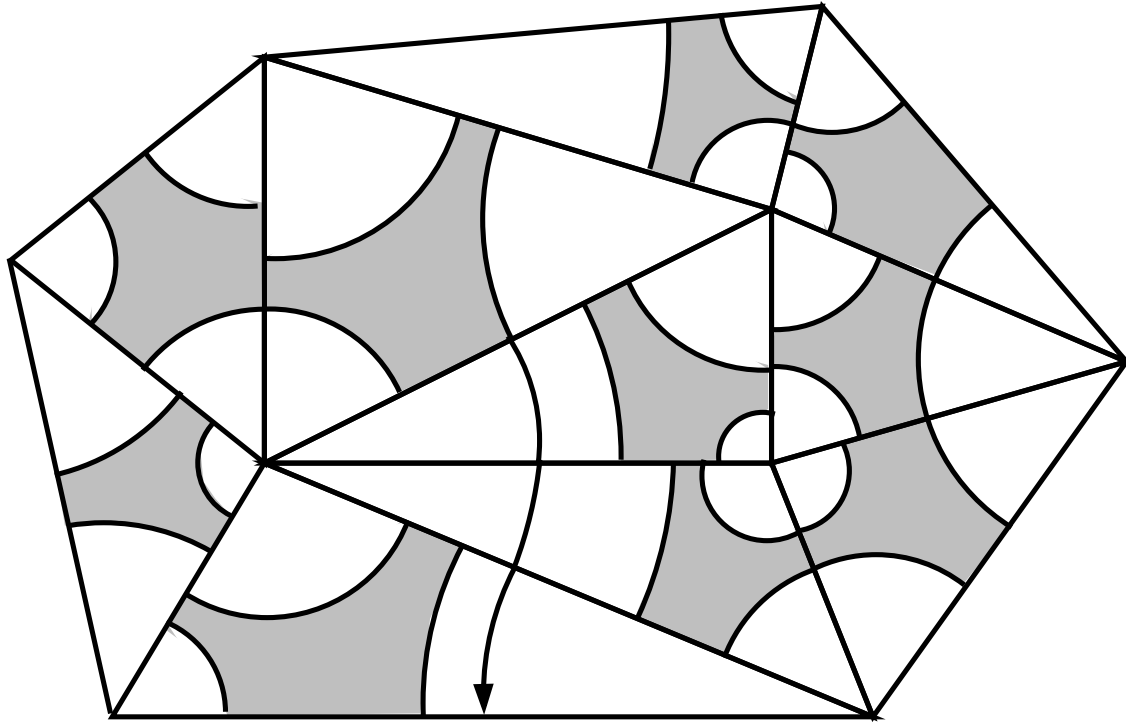

- Start with any triangulation.
- Make thick/thin parts.
- Propagate vertices until they leave thin parts.

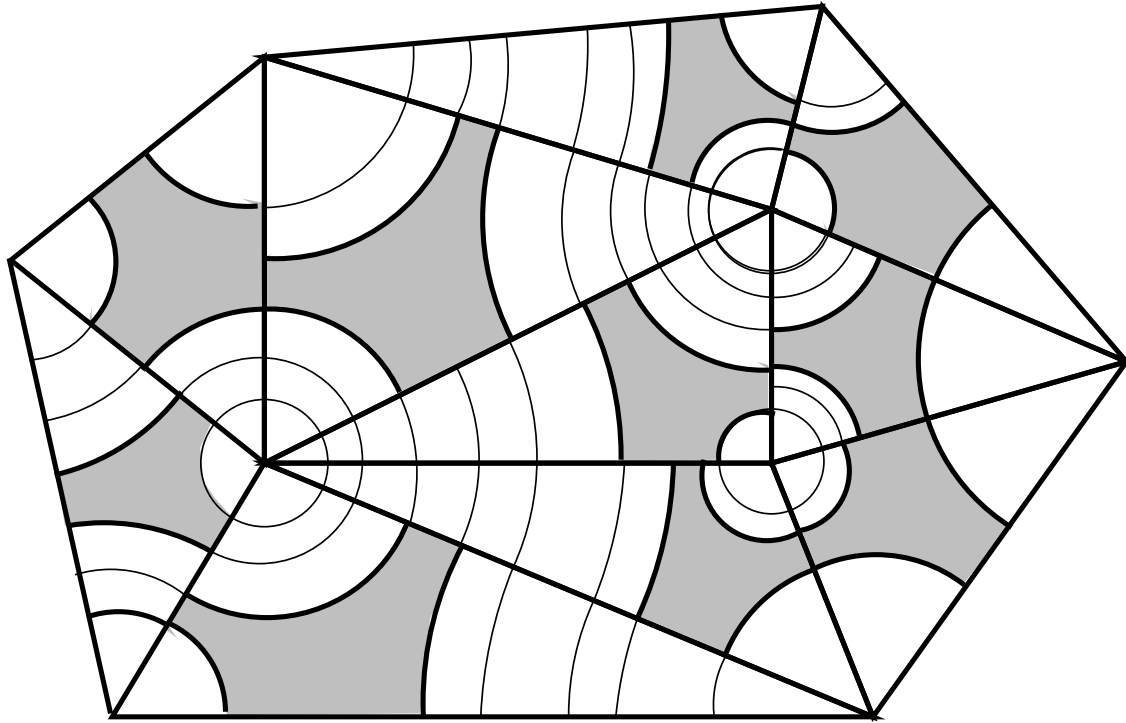

- Start with any triangulation.
- Make thick/thin parts.
- Propagate vertices until they leave thin parts.

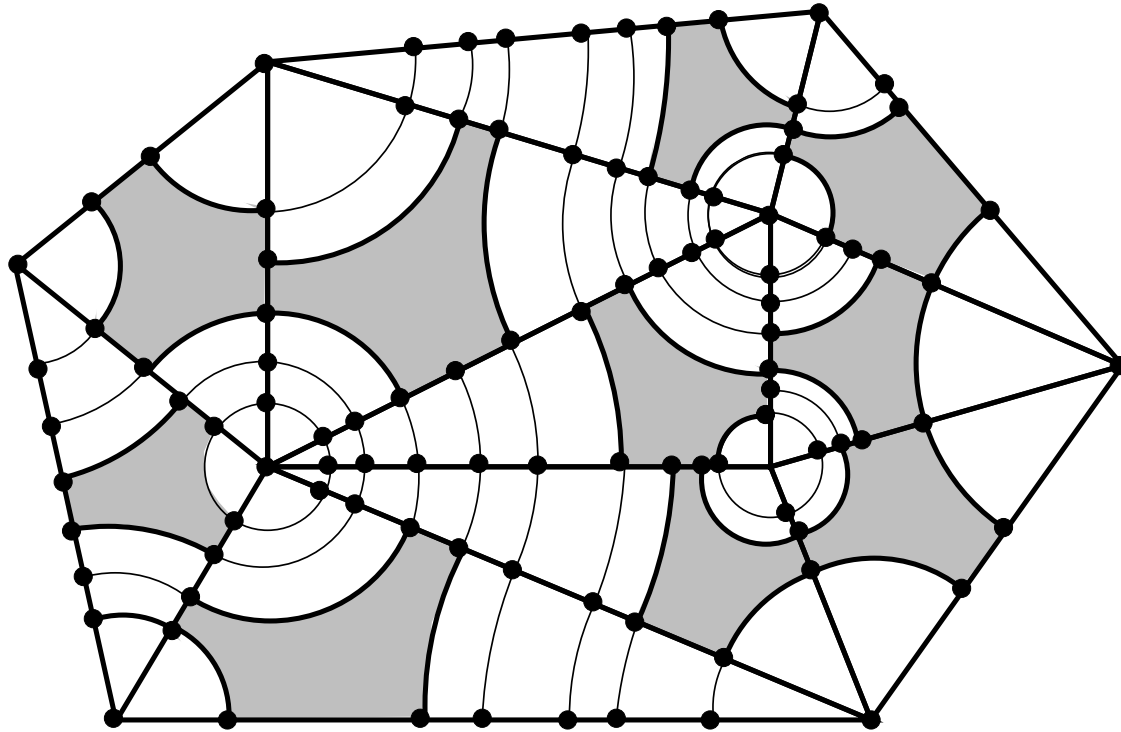

- Start with any triangulation.
- Make thick/thin parts.
- Propagate vertices until they leave thin parts.
- Intersections satisfy Gabriel condition. Why?



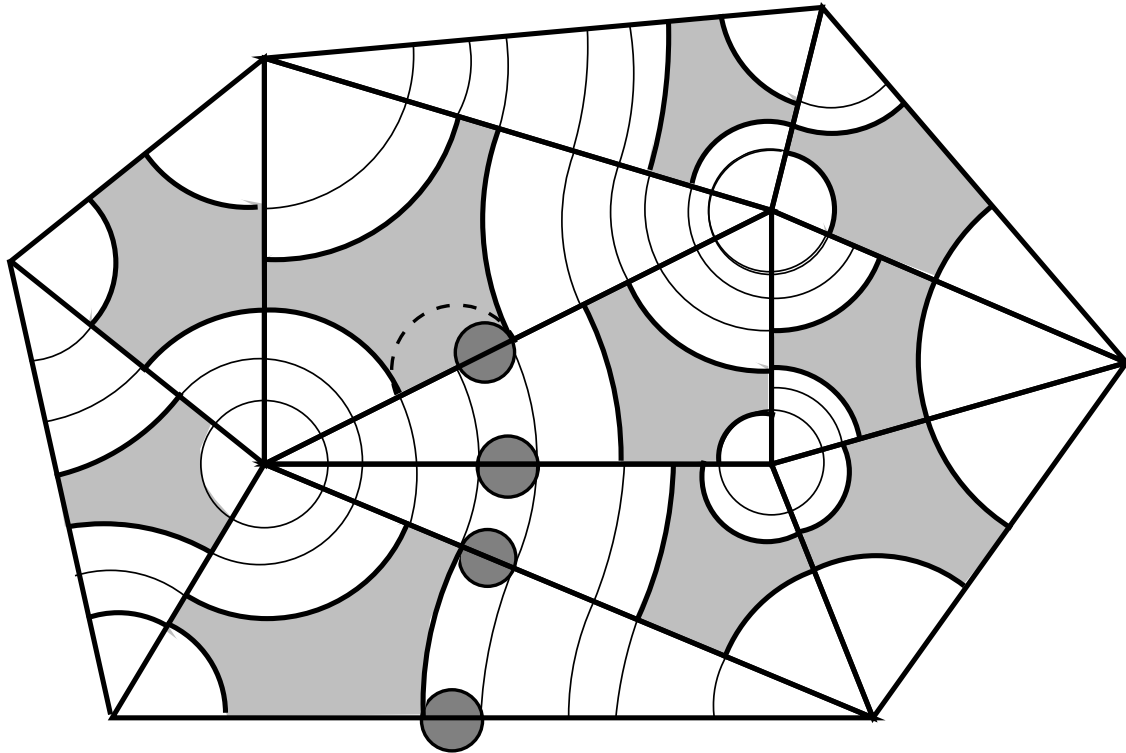

Tube is “swept out” by fixed diameter disk.

Disk lies inside tube or thick part or outside convex hull.

In triangulation of a  $n$ -gon, adjacent triangles form tree.

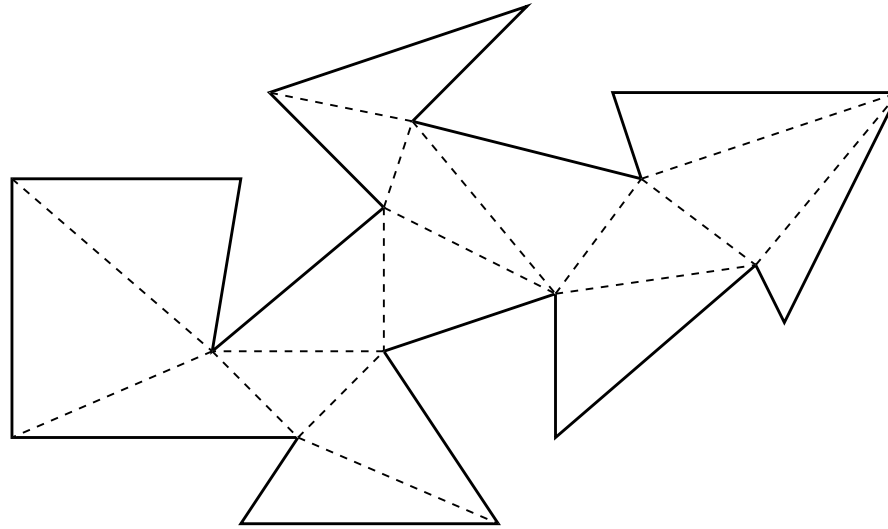

In triangulation of a  $n$ -gon, adjacent triangles form tree.

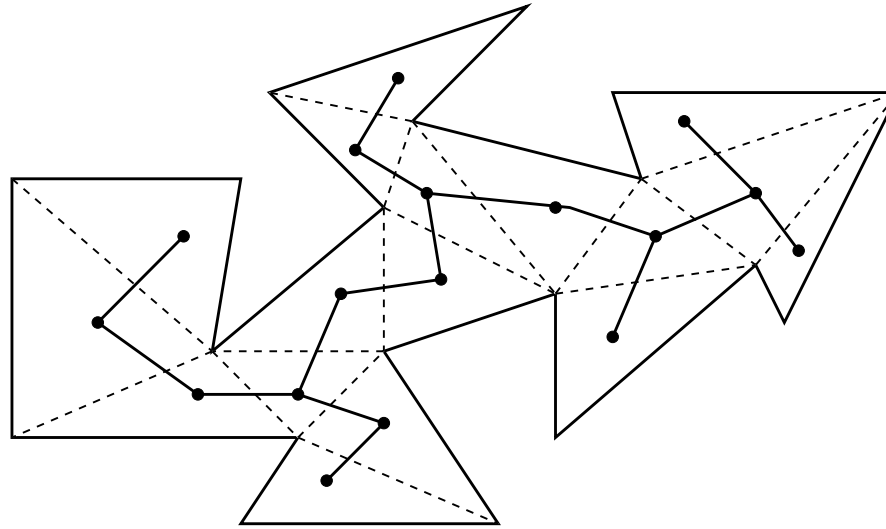

In triangulation of a  $n$ -gon, adjacent triangles form tree.

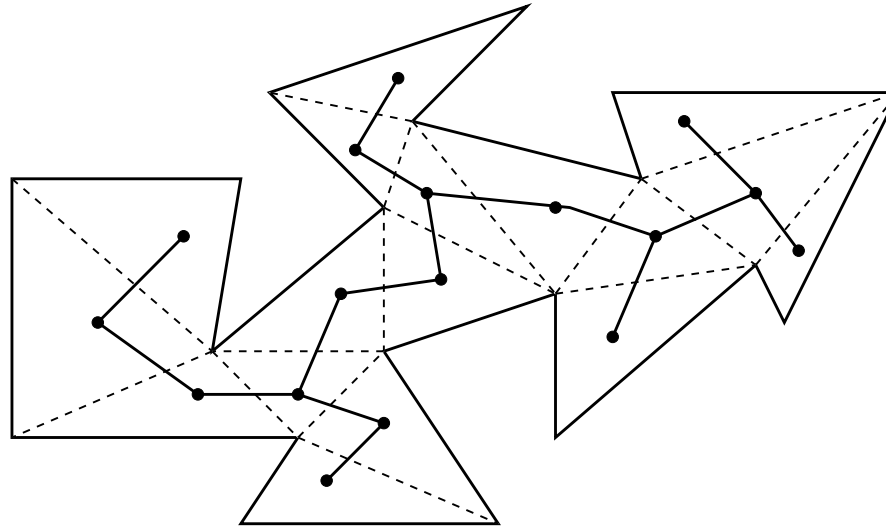

Hence foliation paths never revisit a triangle.

$O(n)$  starting points, so  $O(n^2)$  points are created.

**Thm:** Triangulation of a  $n$ -gon has a  $O(n^2)$  NOT.

Improves  $O(n^4)$  by Bern and Eppstein (1992).

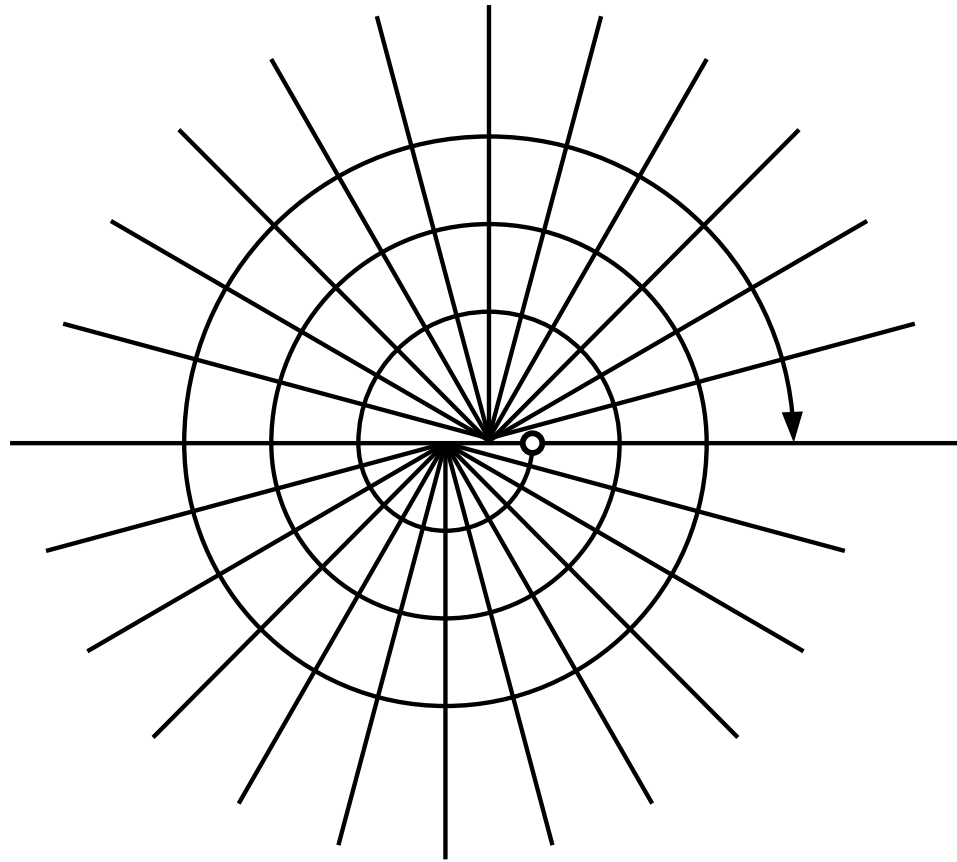

General case has “spiraling paths” that revisit triangles.

**Idea:** perturb paths to terminate sooner.

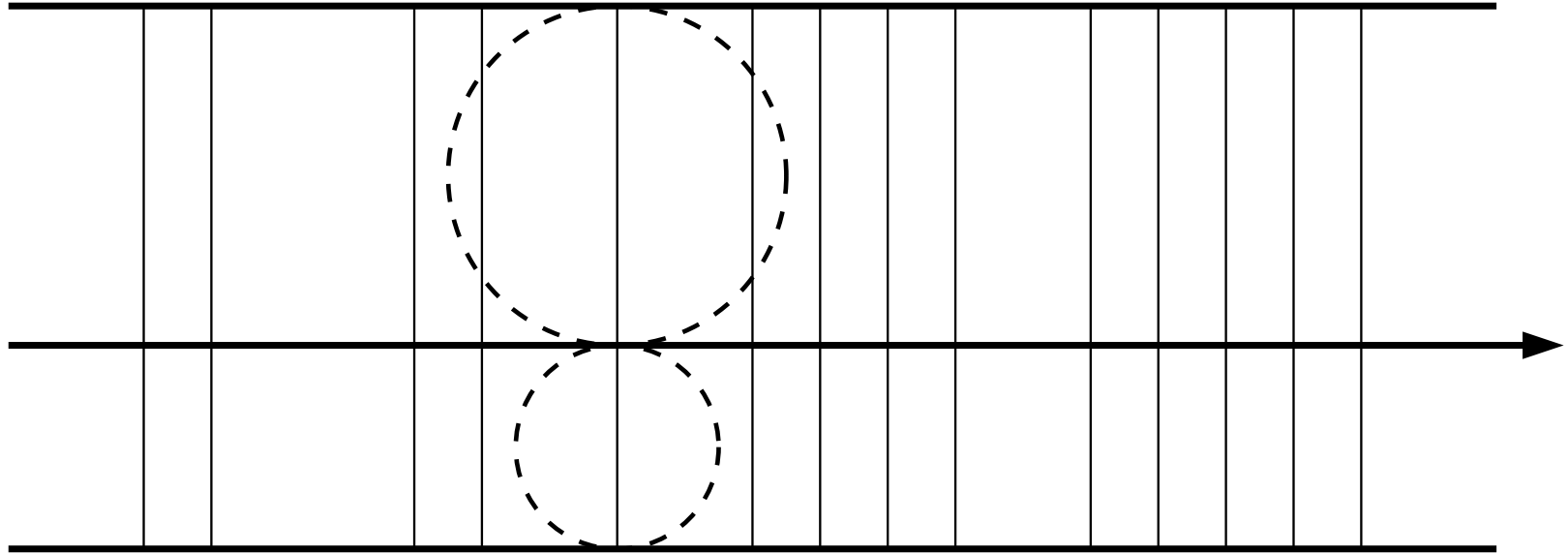

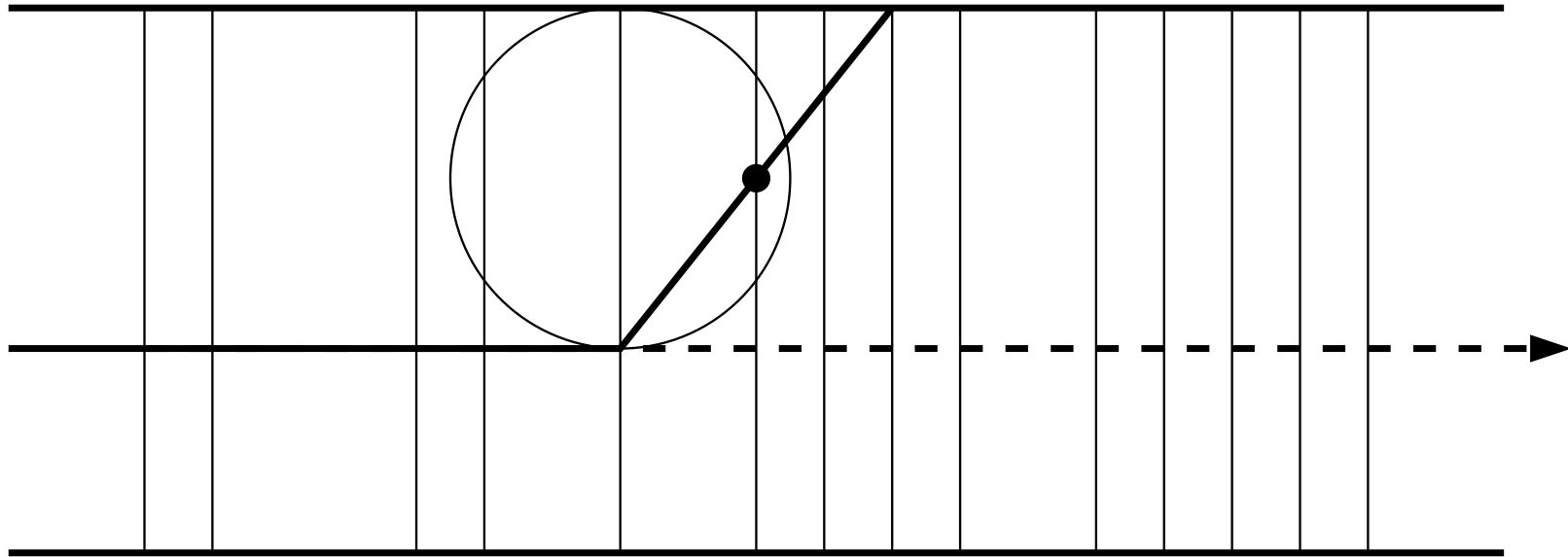

If path bends too fast, Gabriel condition can fail.

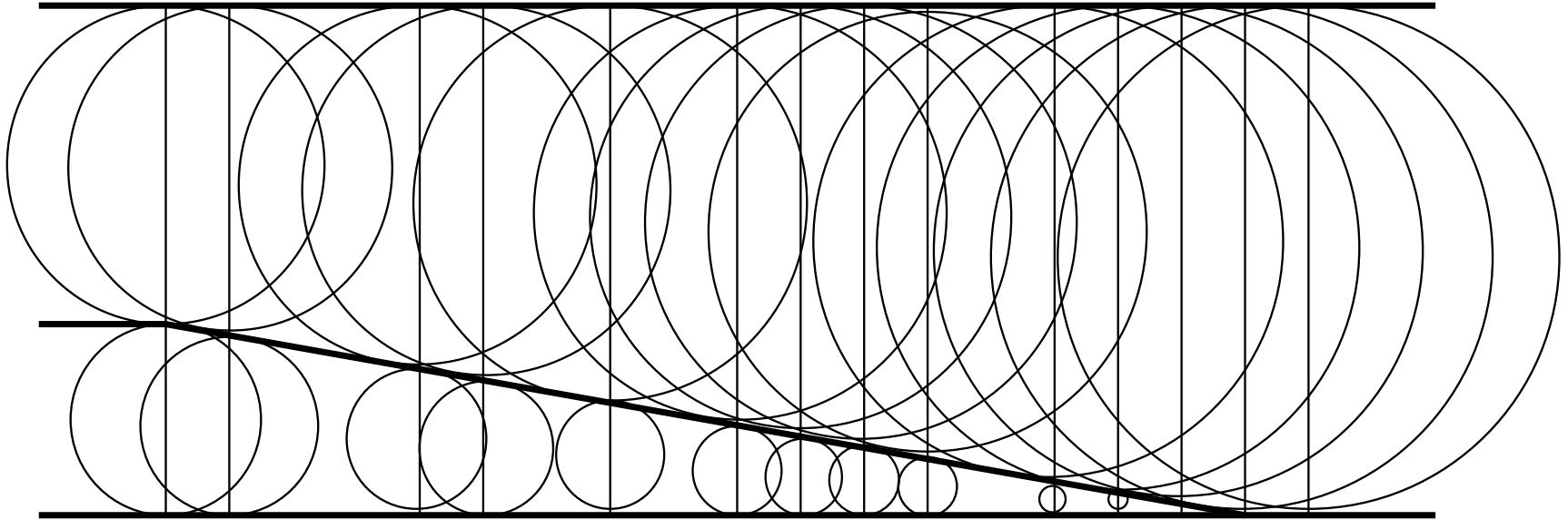

Bend slowly enough to satisfy Gabriel condition.



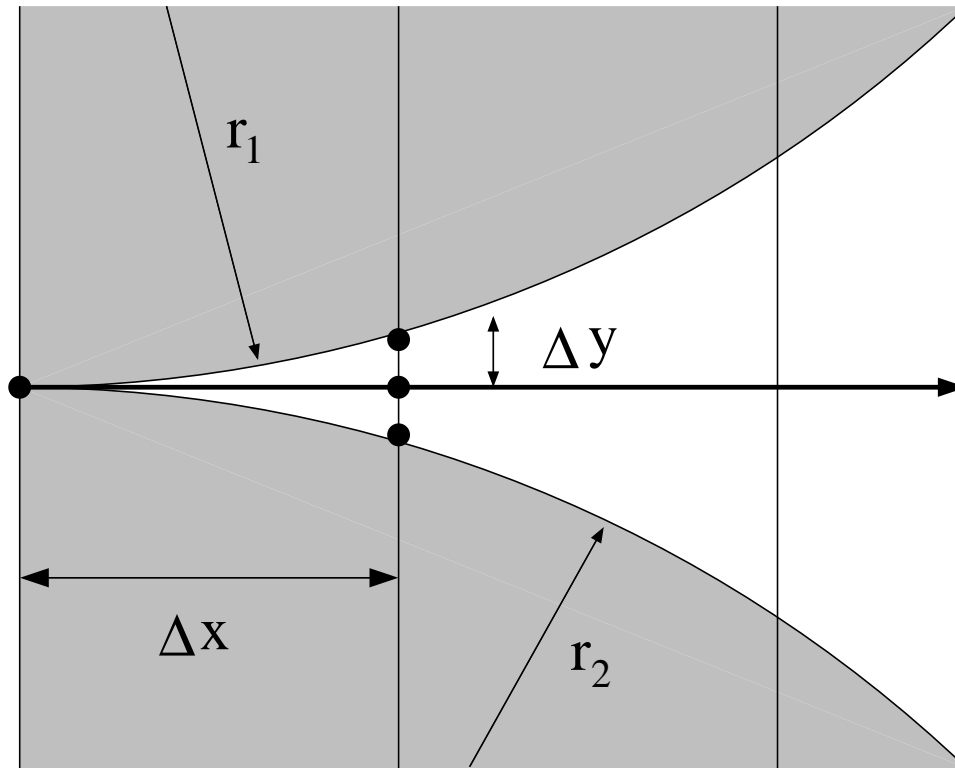

$$\Delta y \approx (\Delta x / r)^2 r = (\Delta x)^2 / r.$$

$$r = \max(r_1, r_2).$$

*DT or NOT-DT, that is the question.*

*Whether 'tis nobler in the mind to suffer  
the slings and arrows of obtuse angles,  
or take arms against a sea of paths,  
and by perturbing end them?*

## Questions:

- Implementable?
- Average versus worst case bounds?
- Improve 2.5 to 2?
- 3-D meshes? The eightfold way? Ricci flow?
- Other applications for thick/thin pieces?
- Applications of Mumford-Bers compactness?
- Best  $K$  for medial axis map? ( $2.1 < k < 7.82$ )
- Can we do better than medial axis map?